

KIM1

Datasheet

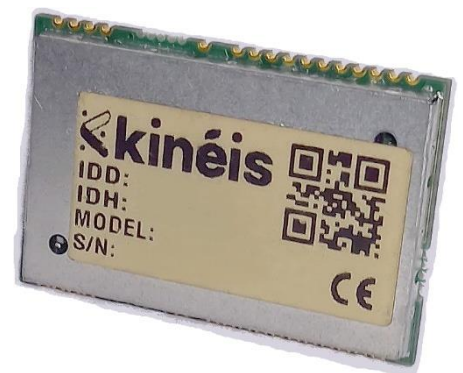

Reference:	KINEIS-SP-20-0147
Issue:	1.2
Date:	February 8, 2022

TABLE OF CONTENTS

1. Introduction	4
1.1. Versioning	5
1.2. Revision history	6
1.3. Related documents	6
2. Product description	7
2.1. Overview	7
2.2. Main features	7
2.3. Functional description	8
2.4. Commands / controls	9
2.5. State transition diagram	9
3. Electrical specifications	10
3.1. Absolute Maximum Ratings	10
3.2. Nominal Operation Ratings	11
3.2.1. Electrical	11
3.2.2. Radio frequency	11
3.2.3. Logic	12
3.2.3.1. Digital inputs	12
3.2.3.2. Digital outputs	12
3.3. Current consumption	13
3.3.1. Consumption profile overview	13
3.3.2. Transmission mode	14
3.3.2.1. TCXO warmup	15
3.3.2.2. VPA_ON, Tx status	15
3.3.2.3. Transmission	16
3.3.2.4. Variation of temperature	17
3.3.2.5. Overall consumption for typical transmission cycle	17
4. Module pin-out	18
4.1. Pad assignments	18

4.2. Pin descriptions	19
5. Mechanical specifications	21
5.1. Module dimensions	21
5.2. Pin intervals	22
5.3. PCB Footprint	23
6. Storage and soldering	24
6.1. Storage information	24
6.1.1. Storage and handling	24
6.1.2. Moisture sensitivity	24
6.2. Soldering process	25
7. Ordering and Marking	26
7.1. Ordering	26
7.2. Marking	27
8. Additional information	28
8.1. Contact and support	28
8.2. Known-issues	28
8.2.1. Power supply instabilities	28
8.2.2. Impedance issue	28
8.3. Specific terms of use	28
8.4. Frequency Use	29
8.5. Certificate of conformance	29
8.5.1. CE	29
8.5.2. FCC	29
8.6. Legal notices	29
Appendix A – EU type Examination Certificate	30

List of figures

Figure 1: KIM1 functional diagram	8
Figure 2: KIM1 state digram	9
Figure 3: Typical consumption profile overview	14
Figure 4: Typical current consumption profile for TCXO warmup.....	15
Figure 5: Typical current consumption profile for VPA_ON and Tx status	15
Figure 6: Current consumption profile for transmission at different power values	16
Figure 7: Consumption profile for transmission at limit temperature value	17
Figure 8: KIM1 pad assignments	18
Figure 9: KIM1 mechanical dimensions	21
Figure 10: Pin pitches and placements	22
Figure 11: PCB footprint.....	23
Figure 12: Temperature profile for soldering	25
Figure 13: Individual antistatic bags and 50 units plastic trays	26
Figure 14: KIM1 marking.....	27

1. Introduction

Kinéis products makes satellite connectivity easy to access and it is our goal to make integration and industrialization process as streamlined as possible.

The KIM1 module developed by Kinéis is a low-power transmitter module based on Argos-2 standard and fully certified by Kinéis and CNES (French Space Agency).

It enables communication with all the Kinéis/Argos polar LEO satellites and provides global connectivity to IoT devices for data collection and positioning. The use of Argos RF signals and protocols ensures very low power consumption for device within line of sight of Kinéis/Argos satellites.

The module is specifically designed for ease of use, to shorten development time and thus decrease time to market. It offers IoT device manufacturers the possibility to integrate their end devices quickly and easily into the Kinéis network and is available for industrialization of satellite connected device in large volumes.

This document is the datasheet for the KIM1 transmitter module by Kinéis, which is complemented by the integration (see §Error! Reference source not found. Error! Reference source not found. for reference).

Warning: Please refer to the paragraph below, **1.1 Versioning**, to make sure you are reading the documentation suited to your module version.





For further assistance, feel free to contact Kinéis at the following link: <https://www.kineis.com/contact/>

1.1. Versioning

Please refer to the table below to identify the version of the documentation (Datasheet and Integration Manual) related to your module series, considering the following information:

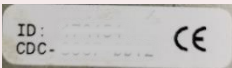
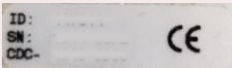
- The hardware (HW) version, determined by the Serial Number
- The firmware (FW) or software (SW) version, determined with the AT command AT+FW=?

Warning: most of the time, the Serial Number can be an indication for the FW version looking at the correspondence table below. However, the FW version must be finally determined with the AT command AT+FW=?, since the KIM1 may have been reprogrammed with a newer FW version after manufacturing.

Label	Serial Number	Manufacturing FW version	Datasheet reference and version	Integration Manual reference and version
 	0719 -xxxx 1219 -xxxx 0120 -xxxx 0220 -xxxx	KIM_HW1.1_ • SW0.2 • SW1.0 KIM_HW1.3_ • SW1.0 • SW1.1 • SW1.2	<i>KINEIS-SP-20-0147 KIM1 Datasheet v1.0.pdf</i>	<i>KINEIS-NT-19-0018 KIM1 Integration Manual v2.0.pdf</i>
	KIM132008 xxxxx	KIM_HW1.3_SW1.3	<i>KINEIS-SP-20-0147 KIM1 Datasheet v1.2.pdf</i>	<i>KINEIS-NT-19-0018 KIM1 Integration Manual v2.0.pdf</i>
	KIM132103 xxxxx	KIM1_V1.4	<i>KINEIS-SP-20-0147 KIM1 Datasheet v1.2.pdf</i>	<i>KINEIS-NT-19-0018 KIM1 Integration Manual v2.1.pdf</i>
	KIM132109 xxxxx	KIM1_V2.0	<i>KINEIS-SP-20-0147 KIM1 Datasheet v2.0.pdf</i>	<i>KINEIS-NT-19-0018 KIM1 Integration Manual v2.2.pdf</i>
	KIM132111 xxxxx KIM132112 xxxxx KIM132201 xxxxx	KIM1_V2.1		<i>KINEIS-NT-19-0018 KIM1 Integration Manual v2.3.pdf</i>

All further modules will be produced and distributed with the latest hardware and software versions. In case of any doubt regarding your module version and corresponding documentation, do not hesitate to contact us.

1.2. Revision history

VERSION	DATE	OBJECT	AUTHOR
V0	Apr 10, 2020	Creation	CT / HC
V1	Jun 16, 2020	Modification Electrical, mechanical & pinning, adding soldering, packaging, and marking	HC / CT
V1.1	Nov 24, 2020	Label evolution	VG
V1.2	Feb 8, 2022	<ul style="list-style-type: none"> - Introduction update, - Reference to the power supply instabilities recommendation note, - Absolute Maximum Ratings updates, - Reference to the 3.3V booster, - PCB footprint update, - Module pictures update, - Marking update, - Versioning update, - Adding of known issues - Reference to the UE-type certificate added, - Legal notices update 	CT / VG / MR

1.3. Related documents

- KINEIS-NT-21-0506 KIM1 power supply instabilities – Recommendation note
- KINEIS-SP-19-0018 KIM1 Integration Manual

2. Product description

2.1. Overview

KIM1 module is designed in SMT package integrating digital and baseband processor based on Argos-2 waveforms, RF transmitter with output power capabilities up to 1W, and controls.

KIM1 module is easy to use with a standard UART interface and communicates with external host by advanced command interface (AT command), as well as available GPIOs.

2.2. Main features

Specification	Description
RF Tx Power	1W calibrated conducted RF level Adjustable at 100 mW, 250 mW, 500 mW, 750 mW*
Frequency Range	399.910 – 401.680 MHz**
Modulation	±1.1rad BPSK (Argos 2 compliant)
Over-the-Air data rate	400 bits/s for LD-A2 modulation
Power Supply	5V
Communication Interface	3.3V UART
DC, Digital & RF Connections	Board edge connection
Package	Surface-mount module
Operating temperature	-20°C to +55°C
Storage temperature	-40°C to +90°C
Humidity	10% - 90% non-condensing
Size	31.2 x 21 x 3.5 mm ³
Certification	Kinéis, CNES, CE

*: specific AT commands to adjust RF level offset for these values are available on demand

**.: until further notice, Kinéis satellites only receive signals in frequency range [401.620 -401.680 MHz].

Please refer to Kinéis/Argos System Specifications for more information, document *Platform Message Transceiver (PMT-A2) Physical Layer Requirements* (reference available in paragraph 1.3 Related documents)

2.3. Functional description

KIM1 is a Kinéis and Argos-2 compliant transmitter; it enables sending messages of typically 23 Bytes (up to 31 Bytes) of useful data to Argos and Kinéis satellites. The module receives AT commands indicating the transmission parameters and message payload and then performs the RF signal modulation processing to transmit the data to the satellite.

The KIM1 block diagram shown below depicts the MCU DSP (RF Digital processor) and internal clock system (TCXO) in charge of Argos-2 modulation, RF sections with power amplifiers and filters, DC supply, control, GPIO and UART section

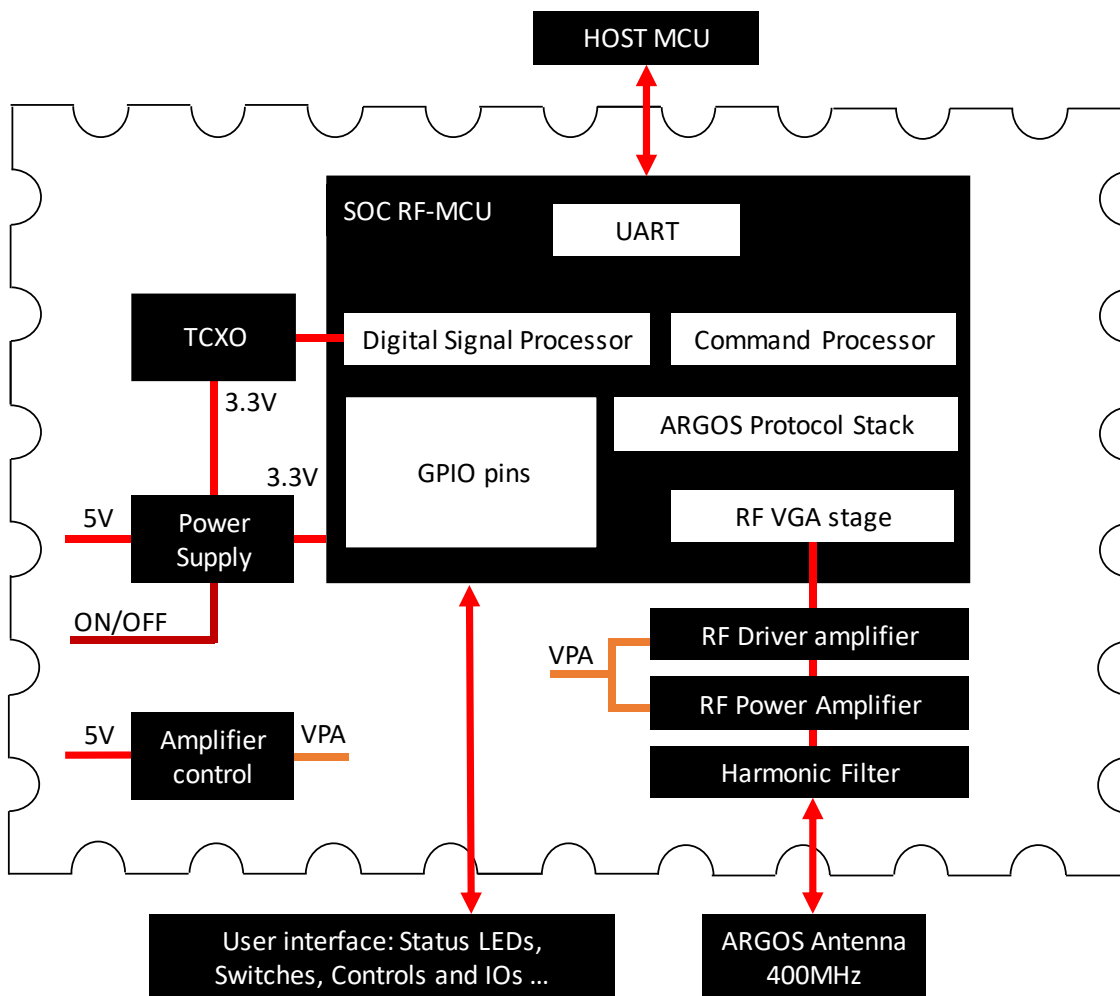

Figure 1: KIM1 functional diagram

2.4. Commands / controls

ON / OFF

A shutdown feature is available on the KIM1 module when VDD pin is powered, controlled via the ON/OFF pin (pin 5, cf fig. 8):

- ON/OFF pin is set to high level: internal regulators are enabled, supplying all internal voltages needed by the module for digital and RF functions.
- ON/OFF pin is set to low level: internal regulators are disabled, digital and RF functions of the module are shut down, reducing drastically the power consumption.

Recommendation: Kinéis recommends powering OFF the module between each transmission to enable low power consumption and longer autonomy.

2.5. State transition diagram

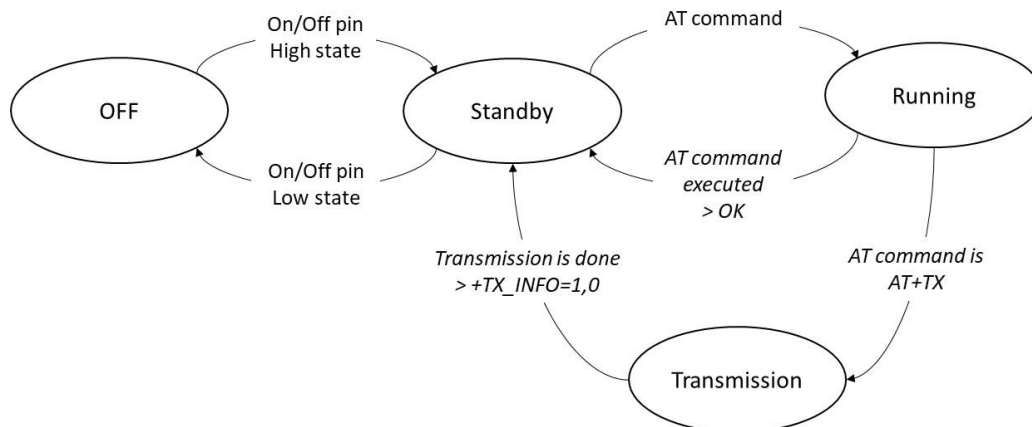

Figure 2: KIM1 state diagram

When the KIM1 is powered at VDD, it can follow different modes:

- **OFF Mode:** when the ON/OFF pin is low, the internal power supply is off, and the consumption is very low (quiescent current of the internal regulator).
- **Standby Mode:** when the ON/OFF pin is high, this is the default mode. The RF digital processor is waiting for AT commands, allowing the transition to the Running Mode.
- **Running Mode:** this mode is activated when the RF digital processor receives an AT command, for the duration of execution of the AT command.
- **Transmission Mode:** this mode is activated when the RF digital processor receives a transmission AT command. It activates the TCXO and the internal power amplifiers, and a signal is transmitted to the antenna corresponding to the specified Kinéis message.

3. Electrical specifications

3.1. Absolute Maximum Ratings

Symbol	Description	Condition	Min	Max	Unit
VDD	Supply voltage		-0.3	5.5	V
IDD	Supply current	VDD=5V		750	mA
Ptot	Total power consumption	VDD=5V		3.75	W
VIO	I/O voltage		-0.3	5.5	V
Ves	Electrostatic handling	HBM*	-1000	1000	V
Top	Operating temperature		-20	+55	°C
Tstg	Storage temperature		-40	+90	°C

*: Human Body Model (HBM), per standard ANSI/ESDA/JEDEC JS-001, all pins

Note: KIM1 module is not protected against reverse voltage. Be careful when supplying module.

The product must be powered by a voltage supply compliant with the applicable security standards and categorized as ES1 or PS1 with a maximum power limited to 15W or less.

Stresses exceeding those listed in the Maximum Ratings table may damage the device. If any of these limits are exceeded, device functionality should not be assumed, damage may occur, and reliability may be affected. Exposure to absolute maximum rating conditions for extended periods may affect device reliability.

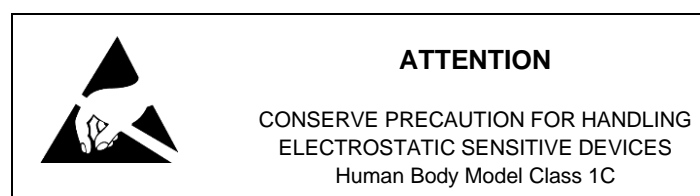

3.2. Nominal Operation Ratings

3.2.1. Electrical

Symbol	Description	Condition	Min	Typ	Max	Unit
VDD*	Supply voltage		4.5	5	5.5	V
IDD	Supply current		200		550	mA
V UART	UART voltage			3.3	5	V
VIO	Other I/O voltage			3.3	3.6	V
Top	Operating temperature		-20	+20	+55	°C

*: Use of a stabilized 5V power supply is recommended; in case of lower supply by external host (ie. 3.3V) a boost converter connected to a source with sufficient supply current is needed. For further information, refer to the *KIM1 Integration Manual* (reference available in paragraph 1.1 Versioning).

3.2.2. Radio frequency

Symbol	Description	Condition	Min	Typ	Max	Unit
TX frequency			401.620		401,680	MHz
TX power			0.1		1	W
TX data rate	LD-A2 modulation			400		bits/s

3.2.3. Logic

3.2.3.1. Digital inputs

Symbol	Description	Condition	Min	Typ	Max	Unit
VIL	Input voltage, low				0.8	V
VIH	Input voltage, high		2			V
VIL_0	Input voltage Low state for ON/OFF pin (5)	VDD=5V			0.8	V
VIH_0	Input voltage High state for ON/OFF pin (5)	VDD=5V	2			V
VIBPC	Input voltage range, for DEBUG and UART			3.3	5.5	V
I _i	Input leakage current		-10		10	μA

3.2.3.2. Digital outputs

Symbol	Description	Condition	Min	Typ	Max	Unit
I _{oH}	Output current, high	VOL=2.4V		8		mA
I _{oL}	Output current, low	VIL=0.4V	2	8		mA
I _{oz}	Tri-State output leakage current	VDD_IO =5V			0.8	mA

Note: The use of LED for status monitoring must be adjusted in current to meet Output current specifications.

UART communication protocol is specified in the *KIM1 Integration Manual* (reference available in paragraph 1.1 Versioning).

3.3. Current consumption

All current consumptions in this paragraph are measured at the nominal supply voltage value 5V.

Note: The use of KIM1 module with lower supply voltage than specified in paragraph 2.2 will significantly decrease the RF performance and the transmission power to the satellite. Kinéis does not guarantee performance nor product liability outside of typical operation ranges.

3.3.1. Consumption profile overview

Mode	Duration (ms)	Current consumption (mA)		
		Min	Typ	Max
-	-			
Off	Controlled by host MCU		9e-6	
Standby	Controlled by host MCU	3.3	3.5*	7
Running**	Negligible			7
Transmission	Transmission cycle consists of TCXO warmup + Transmission, see values in paragraph 3.3.2	see paragraph below		

* Current consumption in standby mode is higher before the first message transmission (typical value 5.5 mA)

** Running mode is an intermediate mode occurring when the module is processing commands, the typical current consumption is very similar to standby mode

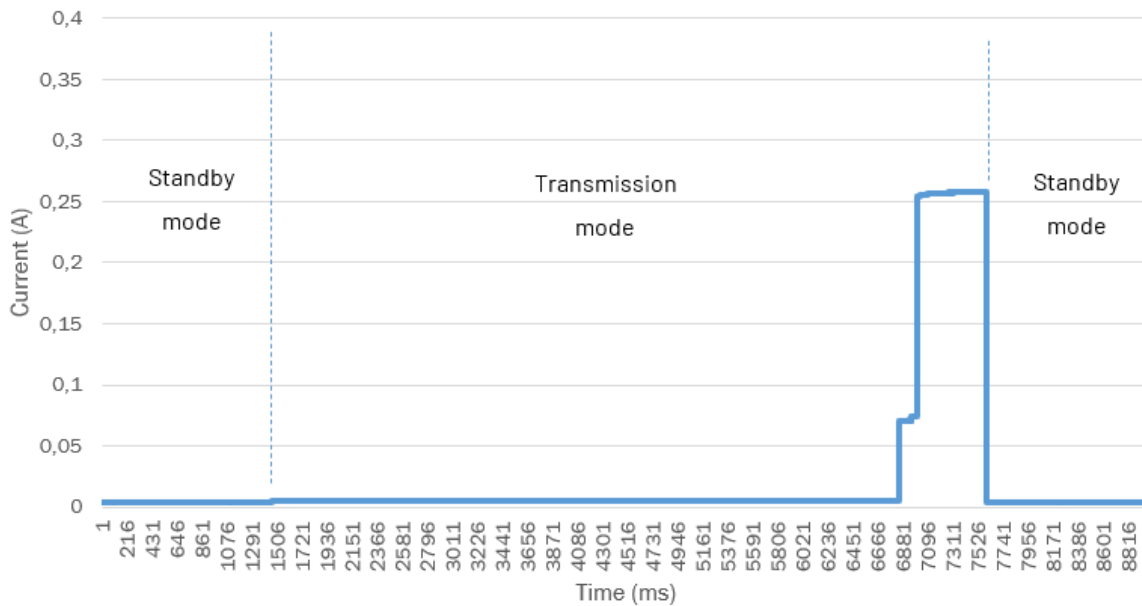

Figure 3: Typical consumption profile overview

3.3.2. Transmission mode

The transmission mode concentrates most of the KIM1 current consumption and depends on the length of the message transmitted, as well as the transmission power configured. After receiving a transmission AT command, the KIM1 begins the TCX0 warmup and then transmits the Kinéis message to the satellite via the RF output.

Below are the duration and current consumption values for the successive steps of the transmission mode:

Status	Duration (ms)	Current consumption (mA)		
		Min	Typ	Max
TCX0 warmup	5000	6	6.5	7
VPA_ON	100	101		111
Tx status	40	104		114
Transmission	[360 - 920] depending on message length	see table below		

* Duration of transmission is detailed in the *KIM1 Integration Manual* (reference available in paragraph 1.1 Versioning)

Note: The table above indicates the current consumption for the first message transmitted, after the module has been shut down or put in Off mode (typical usage scenario). If the module stays On, for the following messages transmitted, current consumption is slightly lower: typical values are 5.5mA for TCXO warmup, 70mA for VPA_ON and 74mA for Tx_status.

3.3.2.1. TCXO warmup

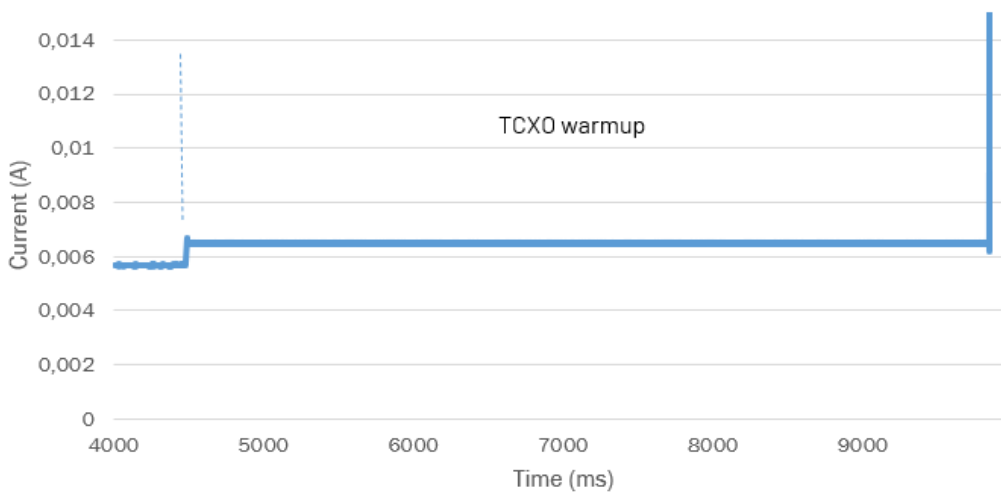

Figure 4: Typical current consumption profile for TCXO warmup

3.3.2.2. VPA_ON, Tx status

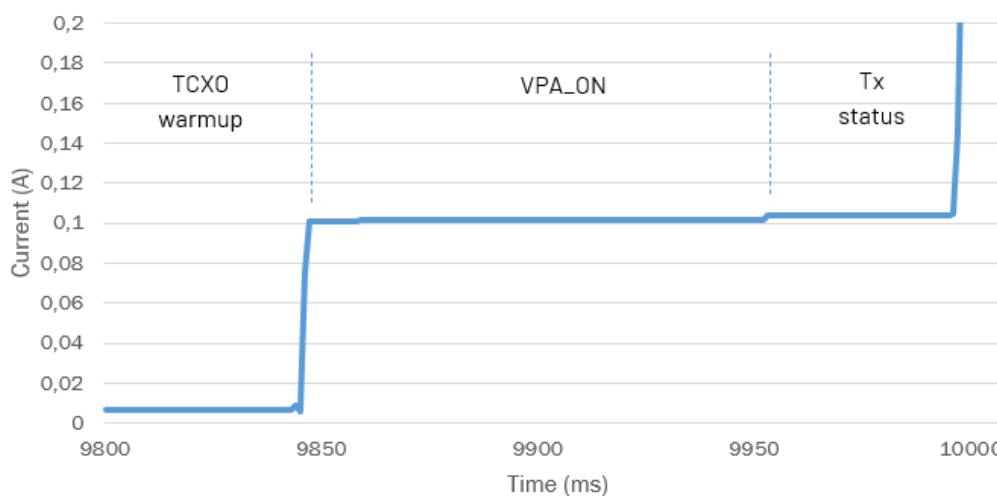

Figure 5: Typical current consumption profile for VPA_ON and Tx status

3.3.2.3. Transmission

The KIM1 current consumption in transmission mode depends on the RF transmission power set by the user. The table below shows the current consumption expected for each of the configurable transmission power values.

TX power configuration (mW)	TX power (dBm)			Current consumption (mA)		
	Min	Typ	Max	Min	Typ	Max
250	23	24	25	200		270
500	26	27	28	250		340
750	27.8	28.8	29.8	380		440
1000	29	30	31	450		550

Note: Consumption and transmission power values are guaranteed at 1W and calibrated at manufacturing. Calibration for 250mW, 500mW, 750mW is not guaranteed.

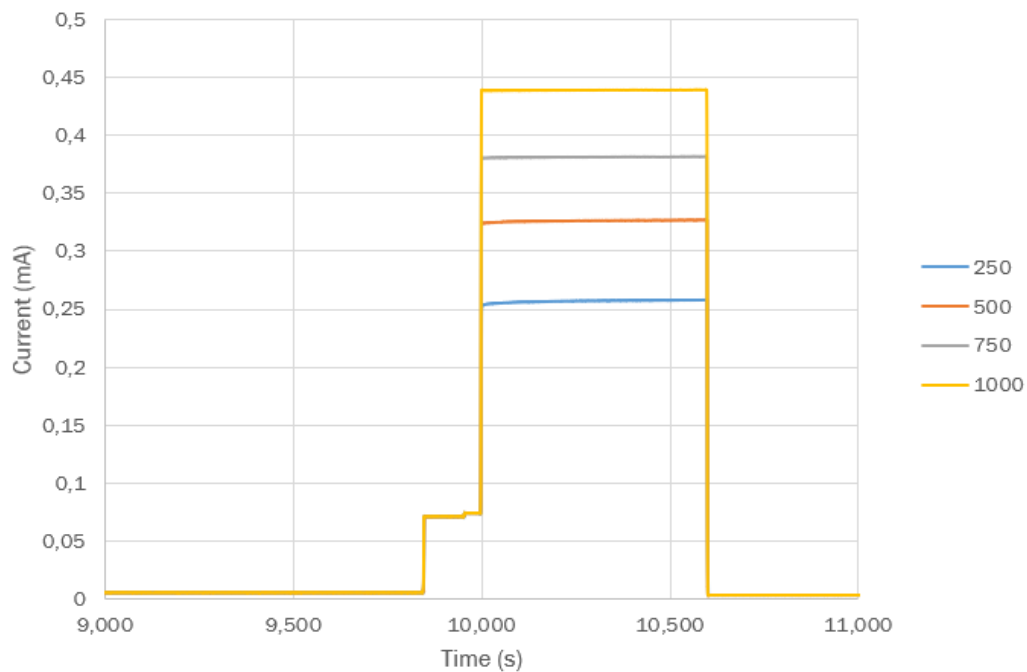

Figure 6: Current consumption profile for transmission at different power values

3.3.2.4. Variation of temperature

When operated at the limit temperatures, current consumption can be increased as shown in the graph below:

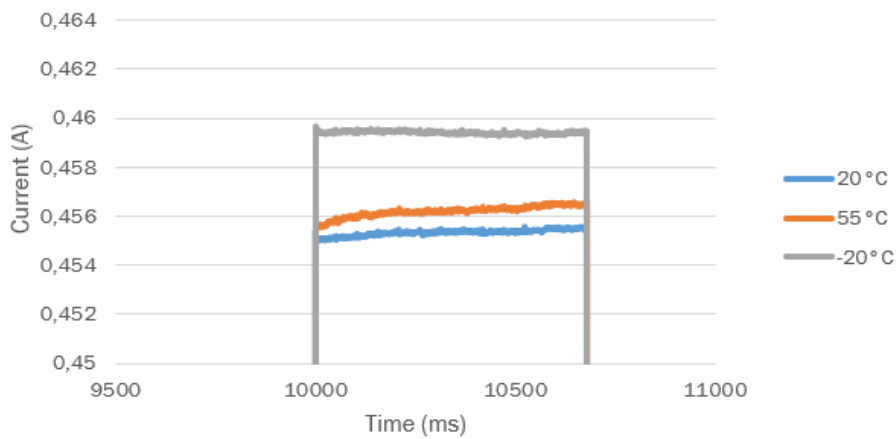

Figure 7: Consumption profile for transmission at limit temperature value

3.3.2.5. Overall consumption for typical transmission cycle

The following table shows the overall consumption in mWh for a typical transmission cycle (transmission mode only), which can give some insight in computing the autonomy of a battery-powered device.

TX power (mW)	Energy consumption (mWh)				
	TCXO warmup	VPA_ON	Tx status	Transmission (31 Bytes)	TOTAL
250	0.045	0.015	0.006	0.319	0.385
500				0.383	0.449
750				0.511	0.577
1000				0.639	0.705

4. Module pin-out

4.1. Pad assignments

The KIM1 is an SMT module with 37 pins dedicated to RF signal transmission, power supply, interface, and control. Ground connections are dispatched along the module to ensure good electrical grounding and mechanical hold. RF_OUTPUT pin is a 50ohm output.

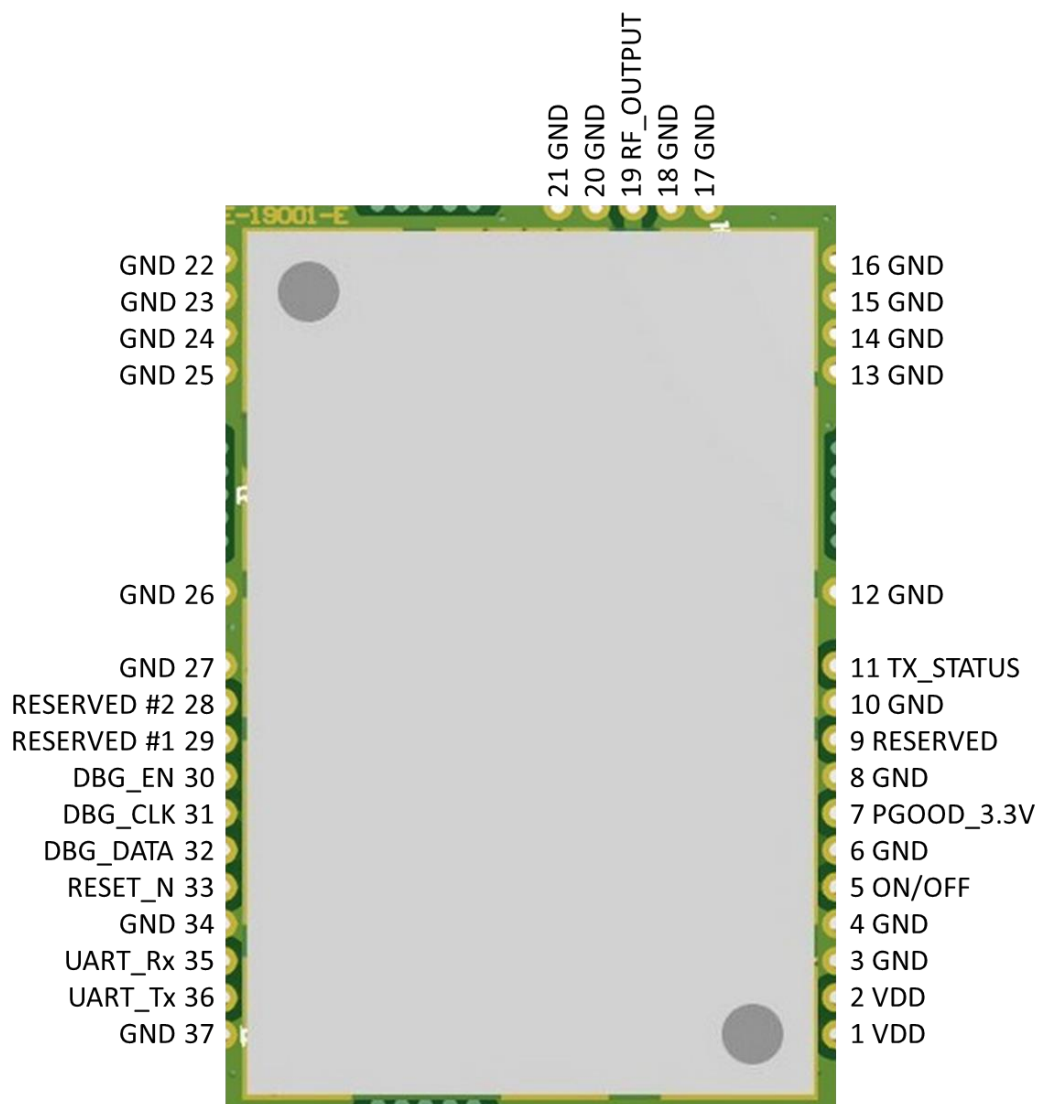

Figure 8: KIM1 pad assignments

4.2. Pin descriptions

The table below gives the pin numbers and status of KIM1 module.

Pin	Name	Type	Description	Comment
1	VDD	Power	Positive supply voltage	5V typical
2	VDD	Power	Positive supply voltage	5V typical
3	GND	Power	Ground	Must be connected to ground
4	GND	Power	Ground	Must be connected to ground
5	ON/OFF	Input	Control of internal regulator, activate RF & digital processor	Module ON: High Module OFF: Low ON/OFF input must be actively terminated
6	GND	Power	Ground	Must be connected to ground
7	PGOOD_3.3V	Output	Internal 3.3V supply presence indicator	Digital and RF processor supplied. Optional LED with 1K Ω resistor can be added as indicator
8	GND	Power	Ground	Must be connected to ground
9	RESERVED	Input/Output	Do not connect	-
10	GND	Power	Ground	Must be connected to ground
11	TX_STATUS	Output	Transmission status	Transmission in progress: High Driving LED possible
12	GND	Power	Ground	Must be connected to ground
13	GND	Power	Ground	Must be connected to ground
14	GND	Power	Ground	Must be connected to ground
15	GND	Power	Ground	Must be connected to ground
16	GND	Power	Ground	Must be connected to ground
17	GND	Power	Ground	Must be connected to ground
18	GND	Power	Ground	Must be connected to ground
19	RF_OUTPUT	RF Analog	RF signal pin (Kinéis) Matched to 50 ohms	RF output to connect to external antenna
20	GND	Power	Ground	Must be connected to ground

Pin	Name	Type	Description	Comment
21	GND	Power	Ground	Must be connected to ground
22	GND	Power	Ground	Must be connected to ground
23	GND	Power	Ground	Must be connected to ground
24	GND	Power	Ground	Must be connected to ground
25	GND	Power	Ground	Must be connected to ground
26	GND	Power	Ground	Must be connected to ground
27	GND	Power	Ground	Must be connected to ground
28	RESERVED#2	Input/Output	Do not connect	-
29	RESERVED#1	Input/Output	Do not connect	-
30	DBG_EN	Input/Pull-down	In-circuit-debugger Enable	3.3V typical
31	DBG_CLK	Input/Pull-up	Debug CLOCK	3.3V typical
32	DBG_DATA	Input/Pull-up	Debug DATA	3.3V typical
33	RESET_N	Input/Pull-up	Device Reset input	3.3V typical - Active: Low Should not be left floating
34	GND	Power	Ground	Must be connected to ground
35	UART_Rx	Input	Communication UART Receive (Data Rx)	3.3V typical - 5V tolerant
36	UART_Tx	Output	Communication UART Transmit (Data Tx)	3.3V typical
37	GND	Power	Ground	Must be connected to ground

The KIM1 module must be integrated under the conditions described in the typical integration circuit of the *KIM1 Integration Manual* (reference available in paragraph 1.1 Versioning). Please make sure to consider these recommendations to avoid any integration issue.

5. Mechanical specifications

The KIM1 is a SMT module with size 31.2mm x 21mm x 3.5mm and a maximum weight of 3g.

The module is made of FR4 standard PCB with pin indentation on 3 sides, allowing soldering onto a host printed circuit board (PCB) using standard reflow process.

The indentations are metalized to ensure good soldering, and the pitches of the pins are standard to allow placement for low-cost manufacturing process on the host application board.

5.1. Module dimensions

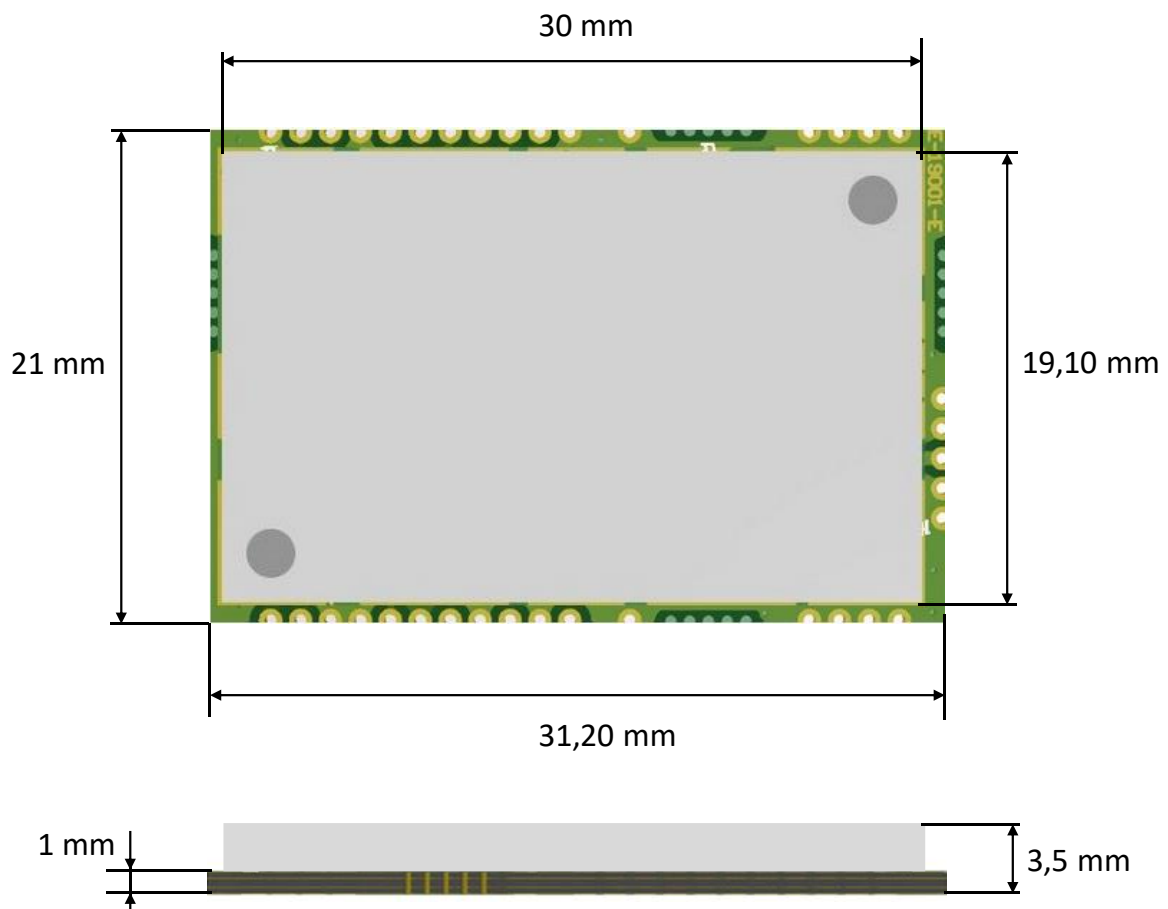

Figure 9: KIM1 mechanical dimensions

5.2. Pin intervals

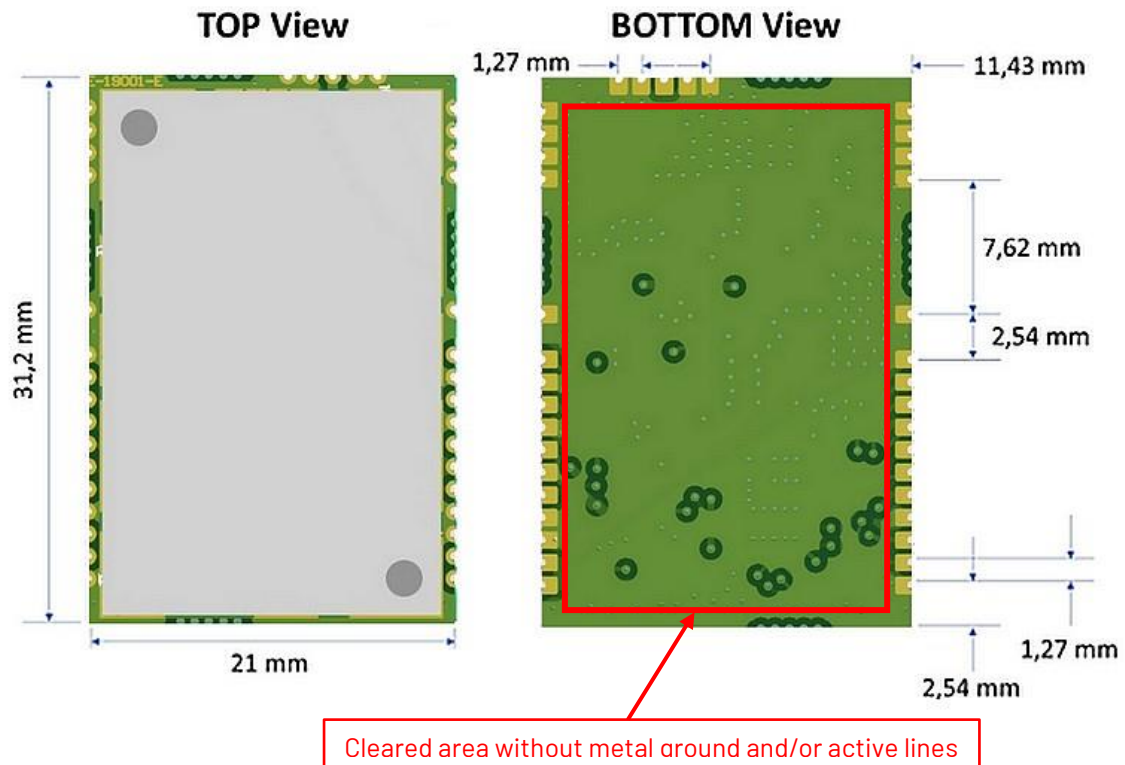

Figure 10: Pin pitches and placements

Important: The KIM1 module has a solder mask on its bottom side. This solder mask covers the metal tracks and vias. To avoid short-circuit, host board area under the module should be left open without metal ground and/or active lines.

5.3. PCB Footprint

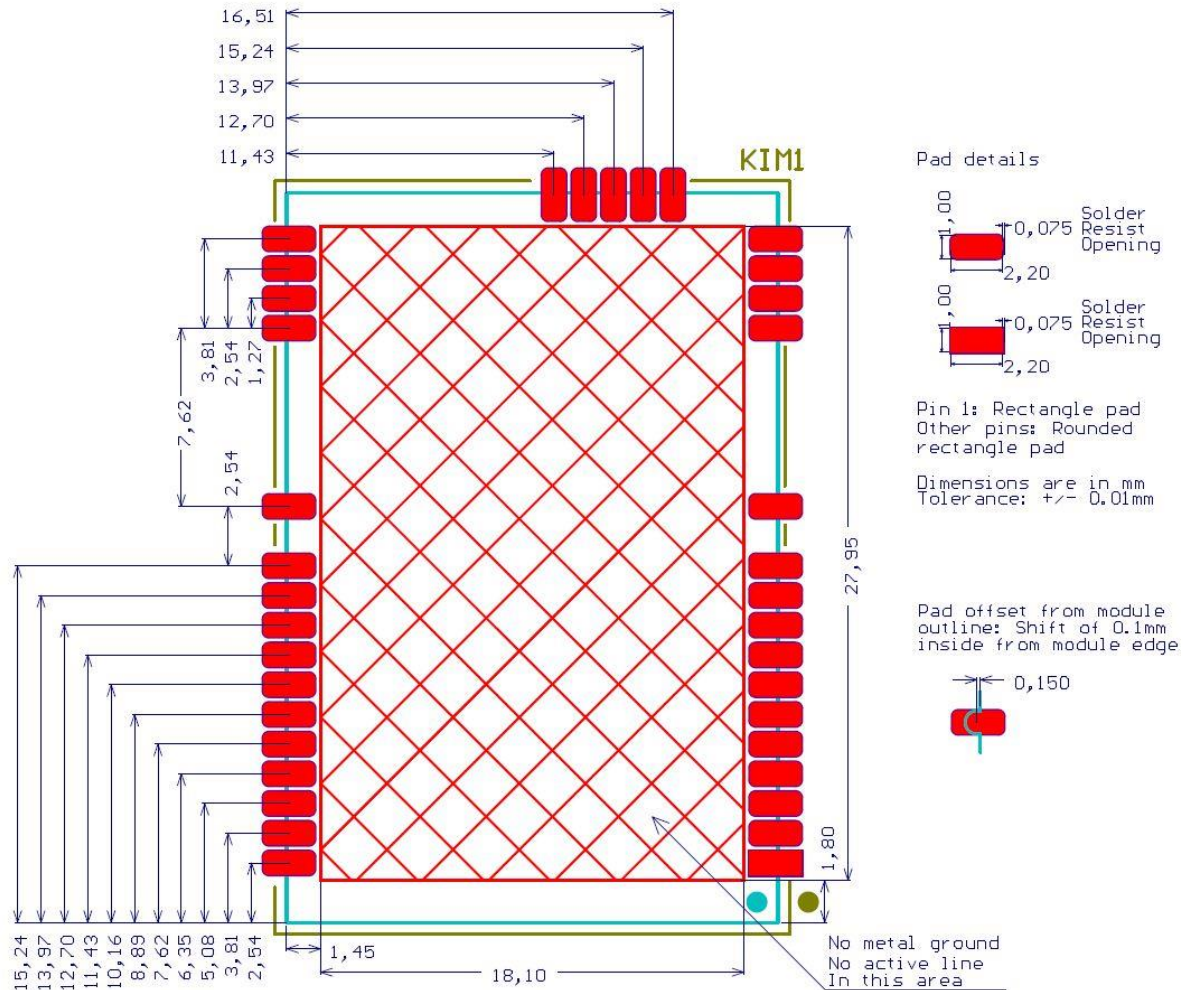

Figure 11: PCB footprint

Note: Altium library symbol and footprint are available on demand

6. Storage and soldering

6.1. Storage information

Kinéis declines all responsibility in case of product malfunction after improper storage or soldering.

6.1.1. Storage and handling

The KIM1 is sensitive to electrostatic discharge, it must be kept in antistatic enclosure during storage.

The storage specifications are detailed on maximum ratings table on paragraph 2.1.

Do not expose the module to the following conditions:

- Corrosive gasses such as Cl₂, H₂S, NH₃, SO₂, or NO_x
- Extreme humidity or salty air
- Prolonged exposure to direct sunlight
- Temperatures beyond those specified for storage

Do not apply mechanical stress.

Do not drop nor shock the module.

Avoid static electricity, ESD and high voltage as these may damage the module.

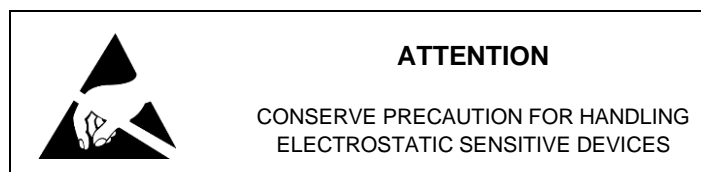

6.1.2. Moisture sensitivity

The KIM1 module has plastic package components which absorb moisture. During typical solder reflow operations when SMDs are module-mounted onto a PCB, the entire PCB and device population are exposed to a rapid change in ambient temperature. Any absorbed moisture is quickly turned into superheated steam. This sudden change in vapor pressure can cause component failures and PCB degradation. We recommend baking the module to avoid these degradations, see paragraph 6.2.

6.2. Soldering process

The KIM1 module is manufactured under ROHS process. As the module has an open shielding, it is sensible to moisture and humidity, we recommend baking the module at temperature of 90°C during at least 12h to avoid issues during manufacturing (see procedure jedec IPC/JEDEC J-STD-033D).

To achieve an optimum reflow process for mounting module on host PCB, we recommend the use of temperature the profile detailed below (see procedure jedec IPC/JEDEC J-STD-020E).

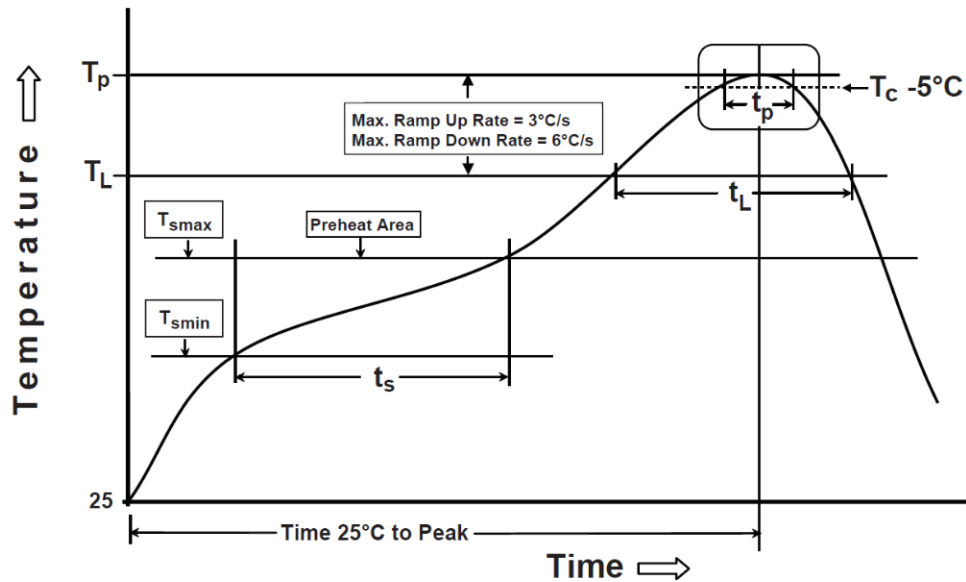

Figure 12: Temperature profile for soldering

Preheat/Soak	
Temperature Min (T_{smin})	150 °C
Temperature Max (T_{smax})	200 °C
Time (t_s) from (T_{smin} to T_{smax})	60-120 sec
Ramp-up rate (T_L to T_p)	3 °C/sec max
Liquidous temperature (T_L)	217 °C
Time (t_L) maintained above T_L	60-150 sec

Peak package body temperature (T_p)	245°C (+0/-5°C)
Classification Temperature (T_c)	260 °C
Time (t_p) maintained above $T_c - 5$ °C	30 sec
Ramp-down rate (T_p to T_L)	6 °C/sec max
Time 25 °C to peak temperature	8 mn max

7. Ordering and Marking

7.1. Ordering

KIM1 modules can be delivered:

- In individual package in thermoformed antistatic bags for small quantities.
- Antistatic trays are proposed in standard quantities of 50 units and multiples of 50 units (complete information about plastic trays is available on request).

All orders of modules are delivered in sealed pack with desiccant pack and humidity sensors.



Figure 13: Individual antistatic bags and 50 units plastic trays

7.2. Marking

Marking of the module is detailed as is, on sticker 23 x 19mm on the shielded cover of the module:

- Kinéis logo and company name
- QR code giving the Serial Number (see description below)
- IDD: 6-digit decimal ID. Used to identify the device on the Argos platform. This ID is unique, unchanged and flashed in production by Kinéis .
- IDH: 7-digit Hexadecimal ID. Used to identify the device in transmitted messages. This ID is unique, unchanged and flashed in production by Kinéis.
- Model: KIM1 V1.3
- S/N: Serial Number on 14 digits, eg KIM132103xxxxx
 - 3 digits for the product type (KIM)
 - 2 digits for the product version (13)
 - 2 digits for the year of production (21)
 - 2 digits for the month of production (03)
 - 5 digits for the product index within the batch (xxxxx)
- Certification logo : CE



Figure 14: KIM1 marking

8. Additional information

8.1. Contact and support

Product information, technical support and commercial contact are available from Kinéis at the following link: <https://www.kineis.com/contact/>

8.2. Known-issues

8.2.1. Power supply instabilities

Depending on the module implementation, the ON/OFF pin might generate power supply instabilities. The documentation KIM1 power supply instabilities – Recommendation note.pdf (reference available in paragraph 1.3 Related documents), enables the integrators to manage this known issue.

8.2.2. Impedance issue

For early version of the module, very specific cases of transmissions with mismatched antenna and high-power reflection could result in filter damage inside the module. Components have been updated to solve this issue and the modules' batches referring to this datasheet are not impacted.

8.3. Specific terms of use

The KIM1 module must be used under the conditions described in the datasheet and in the *KIM1 Integration Manual* (reference available in paragraph 1.1 Versioning).

All voltage, current, duration values written in this document are measured with Kinéis equipment at operating temperature of 20°C and may differ when using a different equipment or setup.

8.4. Frequency Use

The frequency band 401-403MHz is designated by the International Telecommunication Union (ITU) as usable for Global satellite data collection and positioning system as ARGOS. The Centre National Etudes Spatiales (CNES) oversees the Argos program. The CNES endorses Kinéis to operate the frequency band allocated to Argos.

This frequency band is usable with limitations. Please contact Kinéis to verify that your application with KIM1 respects those limitations.

When certified by Kinéis to operate in this frequency band, there are no further limitations whatever countries of European Union.

8.5. Certificate of conformance

8.5.1. CE

The KIM1 module is EU Type certified. See Appendix A for the Examination Certificate.

8.5.2. FCC

The KIM is designed to comply with the FCC standards and is currently under review.

8.6. Legal notices

Kinéis reserves the right to make changes, corrections, enhancements, modifications, and improvements to their products and/or to this document at any time without notice. Information in this document supersedes and replaces information previously supplied in any prior versions of this document.

“Kinéis” and the Kinéis logo are trademarks of Kinéis SAS.

Appendix A – EU type Examination Certificate



Certificat d'Examen UE de type / EU-type Examination Certificate (Organisme Notifié / Notified Body: 0536)

N° 20-104150_C

Fabricant / Manufacturer:

KINEIS

Adresse/Address: 11 rue Hermès 31520 Ramonville-Saint-Agne FRANCE

EMITECH, Service Certification certifie que le produit suivant / certifies that the following product:

Module Radio permettant la connexion au réseau de télécommunication par satellite Argos-Kinéis / Radio module allowing connection to the Argos-Kinéis satellite telecommunication network

Nom commercial / Tradename: KIM1

Marque / Brand: Kinéis

Modèle / Model: KIM1 V1.3

a été vérifié et répond aux Exigences Essentielles du référentiel / has been assessed and meets the Essential Requirements of:

Directive 2014/53/UE

Articles 3.1 a), 3.1 b), 3.2

Procédure d'évaluation de la conformité appliquée / Applied conformity assessment procedure: Annex III, Module B

Rapport d'évaluation / Assessment report: N° 20-104150_R

Règles de certification / Certification rules: DQSS19000FOR00037 (03)

<p>Date: 26 juillet/july 2021</p> <p>Certificateur (nom) / Certifier (name):</p> <p>Signature </p> <p>Date d'expiration (voir annexe 1): 18 mars 2023 / Expiration date (see annex 1): March 18, 2023</p>	<p>Ce certificat d'examen UE de type vaut uniquement pour le(s) modèle(s) présenté(s) et ne préjuge pas de la conformité de la série / This EU-type examination certificate is only effective for model(s) submitted. It does not prejudice of the conformity of the manufactured products.</p> <p>L'utilisation pour tout autre produit est strictement interdite / Use for any other product is strictly prohibited.</p>
--	--

Ce certificat comporte deux annexes / This certificate includes two annexes.

Toutes les modifications qui peuvent remettre en cause la conformité du produit aux exigences essentielles de la présente directive ou les conditions de validité du certificat devront nous être signifiées. Ces modifications peuvent nécessiter une nouvelle approbation sous la forme d'un complément au certificat initial/All modifications to the approved type that may affect the conformity of the radio equipment with the essential requirements of this Directive or the conditions for validity of that certificate shall be notified to us. Such modifications may require additional approval in the form of an addition to the original EU-type examination certificate.

Annexe 1 / Annex 1

Listes des normes appliquées / List of applied standards

- **Article 3.1**

a) **Santé et Sécurité / Health and Safety**

EN 62368-1: 2014 - Audio/video, information and communication technology equipment - Part 1: Safety requirements (IEC 62368-1:2014, modified)

EN 62311: 2008 - Assessment of electronic and electrical equipment related to human exposure restrictions for electromagnetic fields (0 Hz - 300 GHz)

b) **Compatibilité électromagnétique / Electromagnetic compatibility**

EN 301 489-20 v2.1.2* - ElectroMagnetic Compatibility (EMC) standard for radio equipment and services; Part 20: Specific conditions for Mobile Earth Stations (MES) used in the Mobile Satellite Services (MSS); Harmonised Standard for ElectroMagnetic Compatibility

** Note: la publication par l'ETSI d'une version v2.2.1 est actuellement prévue le 18 mars 2022. Un nouvel examen devra être mené au plus tard 1 an après la publication de cette version: 18 mars 2023 / the publication by ETSI of a version v2.2.1 is currently scheduled for March 18, 2022. A new examination must be carried out no later than 1 year after the publication of this version: March 18, 2023.*

EN 301 489-1 v2.2.3 - ElectroMagnetic Compatibility (EMC) standard for radio equipment and services; Part 1: Common technical requirements; Harmonised Standard for ElectroMagnetic Compatibility

- **Article 3.2 Utilisation efficace et optimisée du spectre / Effective and efficient use of spectrum**

ERC/REC 74-01: 1998 (Amended 29 May 2019) - Unwanted emissions in the spurious domain

ARGOS 2 (Issue 3 - Rev 0 - January 2016)** - Platform Transmitter Terminal (PTT-A2) / Platform Message Transceiver (PMT-A2)

*** Considérant la période de 10 ans écoulée entre la parution de l'édition 2 et l'édition 3 de ces spécifications, une surveillance régulière sera effectuée selon cette échéance. Un nouvel examen devra donc être mené avant expiration de cette période de 10 ans: 29 janvier 2026 / Considering the 10-year period between the publication of edition 2 and edition 3 of these specifications, regular monitoring will be carried out according to this deadline. A new review must therefore be carried out before the expiration of this 10-year period: January 29, 2026.*

EN 301 721 v2.1.1 (§4.21, 4.2.2) - Satellite Earth Stations and Systems (SES); Harmonised Standard for Mobile Earth Stations (MES) providing Low Bit Rate Data Communications (LBRDC) using Low Earth Orbiting (LEO) satellites operating below 1 GHz frequency band covering the essential requirements of article 3.2 of the Directive 2014/53/EU

- **Article 3.3**

Aucun acte délégué adopté par la Commission applicable/No applicable delegated act adopted by the Commission.