Oxlife **INDEPENDENCE**



USER MANUAL

PORTABLE OXYGEN CONCENTRATOR

USER: READ THIS MANUAL BEFORE OPERATING THIS DEVICE.
SAVE THIS MANUAL FOR FUTURE REFERENCE.

DEALER: THIS MANUAL MUST BE GIVEN TO THE END USER.

CAUTION 

Important information
to prevent damage
to your Oxlife
Independence

WARNING 

Important safety
information
regarding hazards
that may cause
personal injury

**THROUGHOUT THIS MANUAL THE FOLLOWING
GRAPHICS ARE USED TO DESCRIBE
WARNINGS AND CAUTIONS.**

WARNING 

PLEASE READ THIS OPERATION MANUAL CAREFULLY BEFORE USING THIS DEVICE. BE AWARE OF ALL WARNINGS AND SAFETY INFORMATION. ONLY USE ACCESSORIES APPROVED BY AMERICAN MEDICAL SALES AND REPAIR AND REFERENCED WITHIN THIS MANUAL. IF YOU DO NOT FULLY UNDERSTAND ALL THE WARNINGS, SAFETY PRECAUTIONS, AND OPERATING INSTRUCTIONS CONTACT YOUR AUTHORIZED DEALER OR PROVIDER FOR TECHNICAL SUPPORT.

CAUTION: U.S. FEDERAL LAW RESTRICTS THESE DEVICES TO SALE BY OR ON THE ORDER OF A PHYSICIAN.

TABLE OF CONTENTS

Section 1: Introduction

Symbols Reference.....	1
Specifications.....	2
Contraindications.....	3
Indications for Use.....	4

Section 2: Safety Guidelines

Device Safety Guidelines.....	5-6
Battery and Power Supply Safety Guidelines.....	7-8

Section 3: Product Description

Feature Identification.....	9
Understanding the Control Panel.....	10

Section 4: Operating Instructions

Before Operating.....	11
Location.....	12
Installing/Removing the Battery.....	13
Power Options.....	13-16
Battery Time Management.....	14
AC Power Supply.....	15
DC Power Supply.....	16
Device Settings.....	17-18
Handle Operation.....	19
Handling.....	20
Cannula Use.....	21-22

Section 5: User Alerts and Alarms

Troubleshooting Guide.....	23-24
----------------------------	-------













Section 6: Maintenance, User Care











Maintenance.....	25
Air Inlet Filter Cleaning.....	25-26

Section 7: Accessories and Disposal

Accessory Bag.....	27
Battery Disposal.....	28
Unit Disposal.....	28

SYMBOLS REFERENCE

MEANING	ICON
On/Off Button	
Mode Button	
Continuous Mode	
Pulse Mode	
Breath Detect Icon	
Increase Flow Setting	
Decrease Flow Setting	
Battery Life Indication	
AC/DC Power	
AC/DC Power Battery Charging	
Do not disassemble	
Home (as seen in manual)	

MEANING	ICON
Use No Grease or Oils	
Type B Equipment	
Do Not dispose of in household waste	
Keep Dry in transport and storage	
Not suitable for use in the presence of a flammable anesthetic mixture	
No Smoking while using or near device	
No Open Flames	
Date of Manufacture	
Caution (as seen in manual)	
Auto (as seen in manual)	
Warning (as seen in manual)	

SPECIFICATIONS

DIMENSIONS	
Device Dimensions with Handle/Wheels	H: 20.29 in H: 51.5 cm W: 10.85 in W: 27.55 cm D: 9.45 in D: 24 cm
WEIGHTS	
Device Weight	16.7 lbs.
Cart Kit (Wheels & Pull Handle)	2.17 lbs.
Battery	1.4 lbs.
AC Charger	1.9 lbs.
DC Charger	.37 lbs.
MODES OF OPERATION	
Continuous	0.5 to 3 LPM in 0.5 LPM increments
Pulse	0.5 to 6.0 (8mL-96mL) setting increments
Battery Specification	14.4V Lithium Ion Battery
External Power Supply Power Input	AC power: 120 VAC, 50/60 Hz @ 2.5 amps DC power: 12 VDC
Oxygen Purity	87 - 95.6% in all settings
Operating Temperature	50°F (10°) to 104°F (40°C)
Operating Humidity	10% - 95% @ 82.4°F (28°C)
Operating Environment	Free of smoke, pollutants, and fumes.
Transport/ Storage Temperature	-4°F (-20°) to 140°F (60°C)
Transport/ Storage Humidity	0 -95% non-condensing
Altitude	0-13,123ft or (0-4000m)
Operating Time	24 hours per day when connected to an external AC or DC power source.
Cannula Specification	DO NOT use cannula tubing longer than 7ft (2.13m) when using Pulse Flow Mode Do NOT use cannula tubing longer than 50ft (15.25m) when using Continuous Flow Mode.

CONTRAINDICATIONS

WARNING

- ⚠ Under certain circumstances, the use of non-prescribed oxygen therapy can be hazardous. This device should only be used when prescribed by a physician.
- ⚠ Not for use in the presence of aerosol sprays or flammable anesthetics.
- ⚠ Additional monitoring may be required for patients using this device who are unable to hear or see alarms or communicate discomfort.
- ⚠ The Oxlife Independence is not appropriate for any patient who would experience adverse health consequences as a result of a temporary interruption in oxygen therapy.
- ⚠ The availability of an alternate source of supplemental oxygen is strongly recommended in the case of power interruption or a mechanical failure of the device.
- ⚠ This device is for adult use only. It is not qualified for use by pediatric patients.

INDICATIONS FOR USE

WARNING ⚠







- ⚠ The American Medical Sales and Repair Oxlife Independence is indicated on a prescription basis for the administration of supplemental oxygen. It is not intended for life support, nor does it provide any patient monitoring capabilities.
- ⚠ Federal law restricts this device to sale by or on the order of a physician.
- ⚠ **PRESCRIBED MODE AND FLOW SETTINGS SHOULD ONLY BE ADJUSTED UNDER THE ADVICE OF A PHYSICIAN**

DEVICE SAFETY GUIDELINES

CAUTION !

- ! Locate the Oxlife Independence in a well ventilated area to allow for adequate air intake. Avoid the intake of airborne pollutants, smoke, or fumes.
- ! **DO NOT** block the air inlet or the exhaust vents located on the side of the device.
- ! **DO NOT** cover the device with a towel, blanket, etc.
- ! **DO NOT** drop or insert any objects or liquid into any opening.
- ! Use only approved accessories as specified in this User Manual. Use of non-approved accessories may cause serious damage to the device and will void the warranty.
- ! **DO NOT** leave your Oxlife Independence or batteries in your vehicle or trunk. Extreme hot or cold maybe damage your device.
- ! Locate oxygen tubing and power cords away from hot surfaces and in a manner to prevent tripping hazards.
- ! Avoid creation of any spark near your Oxlife Independence. This includes sparks from static electricity created by any type of friction.

DEVICE SAFETY GUIDELINES**WARNING**







-  Protect electrical power cords from sharp edges to avoid electrical shock and serious physical injury.
-  **DO NOT** use the device with a damaged power cord or plug.
-  Outdoor use must be conducted using battery power.
-  **DO NOT** operate the device on wet surfaces or in standing water, and do not submerge or expose to water. If the Oxlife Independence has been dropped, damaged or exposed to water please contact your authorized dealer for inspection and possible repair of the device.
-  **DO NOT** come in contact with the device when wet.
-  **DO NOT SMOKE WHILE USING THIS DEVICE. KEEP ALL MATCHES, LIT CIGARETTES, CANDLES, OR OTHER SOURCES OF IGNITION AT LEAST 10 FEET FROM THE DEVICE. THIS DEVICE PRODUCES ENRICHED OXYGEN GAS WHICH ACCELERATES COMBUSTION.**
-  **DO NOT** use oil, grease, or petroleum based products on or near the device.
-  **DO NOT** use the device with an extension cord.

BATTERY AND POWER SUPPLY SAFETY GUIDELINES

CAUTION !

- ! Use of non-approved battery or power supply may cause serious damage to the device and will void the warranty.
- ! **DO NOT** use the battery or power supply for anything other than its intended purpose.
- ! **DO NOT** drop the battery or expose it to mechanical shock.
- ! **DO NOT** expose the battery to water or other liquids.
- ! **DO NOT** expose the battery to excessive heat or cold.
- ! Store the battery in a cool dry place when not in use.
- ! Remove the battery from the device if it will not be used for an extended period of time.
- ! Locate the external power supply in the open air to prevent overheating when in use.

BATTERY AND POWER SUPPLY SAFETY GUIDELINES**WARNING**

-  The battery may explode if exposed to or disposed of in a fire.
-  Use only the supplied battery; AC and/or DC power adapters that were provided with the device.
-  Keep the battery away from children.
-  Use of a damaged battery or power supply may cause personal injury.
-  **DO NOT** attempt to disassemble the battery or power supply.
-  **DO NOT** short circuit the battery's metal contacts with metallic objects such as keys or coins. It may cause sparks or excessive heat.

FEATURE IDENTIFICATION

1. CONTROL PANEL
2. LCD DISPLAY
3. OXYGEN OUTLET PORT
4. AIR INTAKE PORT FILTER
5. WHEELS
6. RECHARGEABLE BATTERY SLOTS
7. FAA APPROVAL IDENTIFICATION
8. PULL HANDLE
9. EXHAUST PORT
10. EXTERNAL POWER INPUT
11. HANDLE LOCK/RELEASE BUTTON
12. CARRY HANDLE

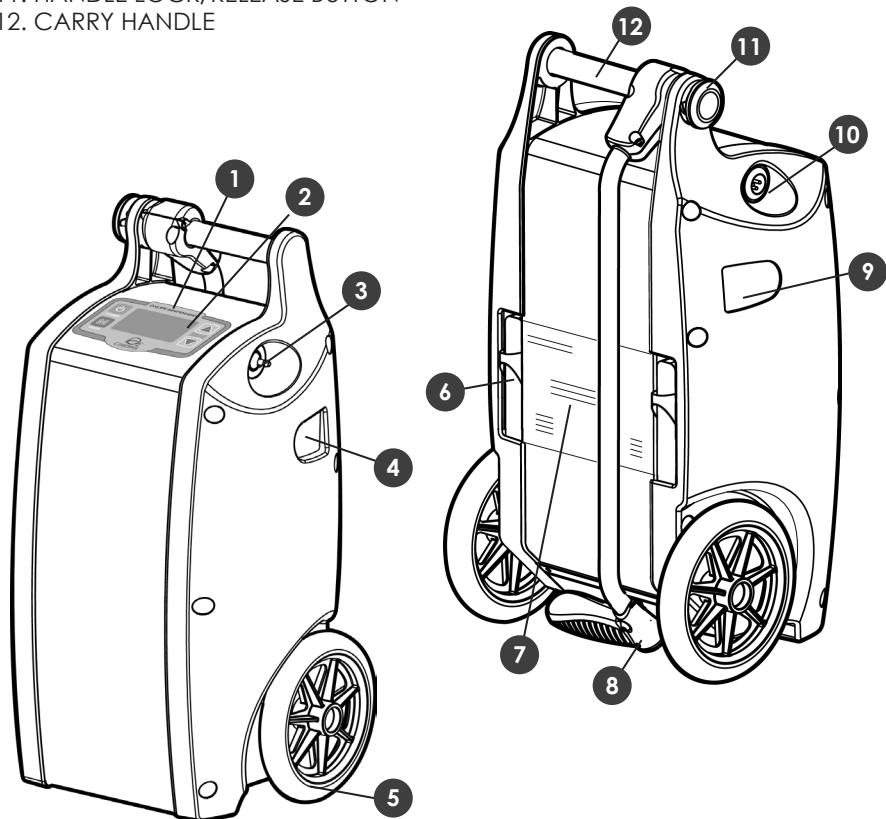

UNDERSTANDING THE CONTROL PANEL

13. POWER
14. BATTERY STATUS
15. EXTERNAL POWER SOURCE
16. INCREASE/UP
17. DECREASE/DOWN
18. SYSTEM STATUS
19. BREATH DETECT
20. MODE SETTING
21. MODE

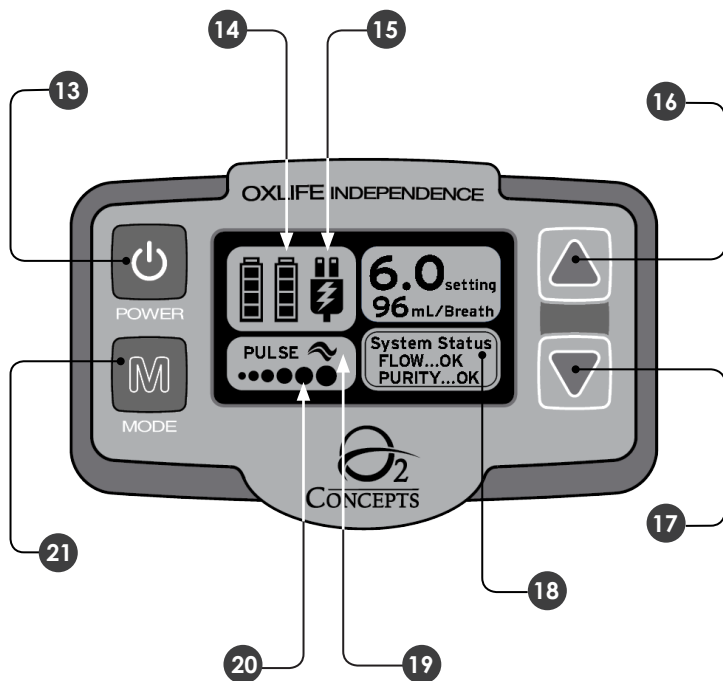

BEFORE OPERATING

- Your authorized dealer will and or should demonstrate proper operation of your Oxlife Independence. This manual should be saved for future reference to help you safely operate your device. If you have any further questions please contact your authorized dealer.
- **DO NOT** operate the Oxlife Independence without first reading the Safety Guidelines included in **SECTION 2** of this manual.
- Please follow all operating instructions.
- If you are relocating your Oxlife Independence from an extreme environment, allow the device to return to the specified operating temperature and humidity ranges before use.
- Operating your device outside of specified ranges may damage your device, impact device performance and may void your warranty. See Operating Temperature and Humidity Ranges listed in the Specification Table.

LOCATING YOUR DEVICE

- Place the Oxlife Independence in a well ventilated area free of smoke, fumes, pollutants, and away from direct sun light.
- Ensure that air intake and exhaust ports are not obstructed.
- The Oxlife Independence **MUST** be located so that alarms can be heard.
- Position the oxygen supply tubing and power cords in a manner that prevents kinking, air flow obstructions, and tripping hazards.
- To protect device finish, it is recommended to use the Oxlife Independence in either an upright position or lying on its back.
- **DO NOT** locate the Oxlife Independence near any flammable materials or cleaning product or in the direct path of any heat source such as a stove, heat register or a car heater. Keep the Oxlife Independence at least 5 feet (1.6m) from hot sparking objects or open flame.

INSTALLING/REMOVING THE BATTERY

Hold the battery vertically with the connection to the bottom, and install it into the back of the device as shown below.

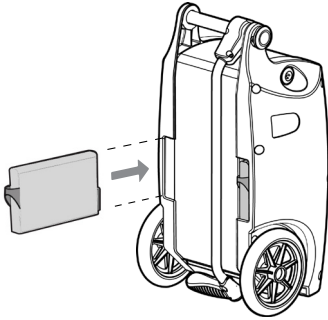

INSTALL

SLIDE INTO BACK OF DEVICE;
BATTERY WILL DROP DOWN SLIGHTLY
AND CLICK INTO POSITION.

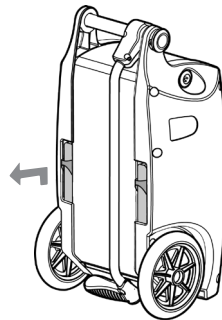

REMOVE

LIFT BATTERY SLIGHTLY UP; THEN
SLIDE STRAIGHT OUT.

TYPICAL RECHARGEABLE BATTERY OPERATION TIMES

(2 Batteries @ 20 Breaths/Minute)

FLOW RATE SETTING	CONTINUOUS FLOW	PULSE FLOW
0.5	5.75 hours	6.25 hours
1.0	5.25 hours	6.00 hours
1.5	3.50 hours	6.00 hours
2.0	2.50 hours	5.75 hours
2.5	2.00 hours	4.75 hours
3.0	1.50 hours	4.00 hours
3.5	N/A	3.50 hours
4.0		3.00 hours
4.5		2.50 hours
5.0		2.25 hours
5.5		2.00 hours
6.0		1.75 hours

BATTERY TIME MANAGEMENT

- With the combined use of the battery, AC power cord, and DC power cord your time away from home is virtually limitless. Using the AC and DC power cords whenever possible will give you optimal battery life. The battery will charge in the device, when plugged into an external power source.
- The Oxlife Independence comes equipped with a rechargeable lithium battery that is **NOT** user serviceable. When fully charged it supplies power for up to 6.25 hours, depending on the setting used.
- The Oxlife Independence battery includes a battery charge status indicator located on the front of the battery. Simply press the "PUSH" button on battery to display the remaining battery life in 25% increments.

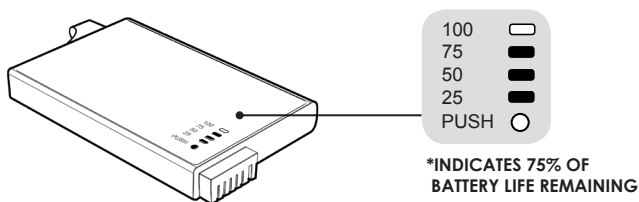

- The typical time to recharge a fully discharged battery is approximately 1.5 hours if charging a single battery and 2.5 hours if charging two with the device plugged into AC power and powered off. Battery Charge times with the device running will vary depending on setting used.
- You will achieve longer battery run time when using your Oxlife Independence in Pulse Flow Mode.
- Battery Charge Status is also displayed on the control panel.



AC POWER SUPPLY HOME

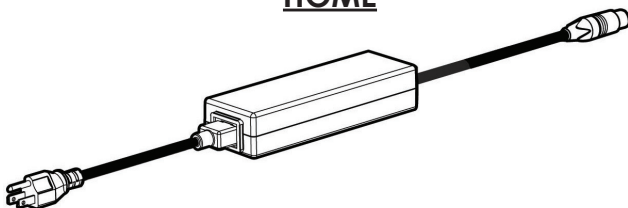

CAUTION

- ❗ Use only the power supplies provided with this device.
- The AC power supply charges the battery using a 100-240 volt 50/60 Hertz outlet (a typical wall outlet in your home). Using the AC power supply allows you to use your Oxlife Independence while simultaneously recharging the battery.
- To use the AC power supply, connect the power supply to the Oxlife Independence and wall outlet as shown below. The external power source icon will be displayed on the control panel. 
- Use no electrical outlets controlled by a switch.
- When charging power sources wait for the control panel to display the new power source icon and unit to beep before removing the original source.

EXTERNAL POWER INPUT

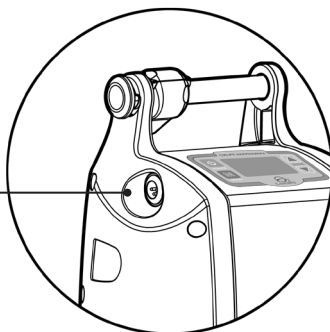



DC POWER SUPPLY AUTO



! Use only the power supplies provided with this device.

! The DC power supply allows you to power your Oxlife Independence from your vehicle's (car, boat, RV) 12/15 volt DC outlet, (cigarette lighter) in all settings. Performance may be affected if voltage is below 12 volts.

! **ALWAYS** have the vehicle's engine running before plugging in your Oxlife Independence. With the engine running, plug in and turn on your device. The external power supply icon will be displayed on the control panel. 





! When operating the Oxlife Independence in your vehicle, ensure that the device is securely stowed and will not get damaged during transport.

! Ensure that air inlet and exhaust ports are not blocked.

! Batteries will not charge at any setting if the engine is not running.

! DC power is not sufficient to charge the batteries at all settings. Charging will not occur at settings higher than Continuous 2.0 or Pulse 4.0.

DEVICE SETTING

1. Turn the device on by pressing the  Power Button.
2. Press the  button to select Continuous or Pulse Flow Mode.
3. Press the Increase  or Decrease  buttons to select the correct flow rate.

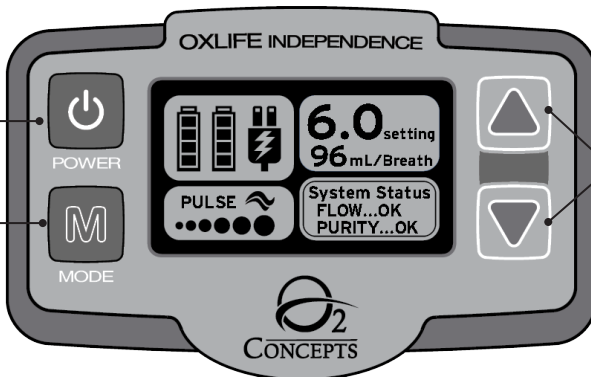

THE PROPER FLOW MODE AND FLOW RATE ARE PRESCRIBED BY YOUR PHYSICIAN. DO NOT CHANGE THESE SETTINGS WITHOUT CONSULTING WITH YOUR PHYSICIAN.

PULSE FLOW MODE SHOULD ONLY BE USED UNDER THE DIRECTION OF YOUR PHYSICIAN. APPROPRIATE AND SAFE PULSE MODE SETTINGS MUST ACCOMMODATE THE INDIVIDUAL PATIENT'S LIFESTYLE INCLUDING REST, TRAVEL AND EXERCISE.



CONTINUOUS FLOW MODE

In Continuous Flow Mode a continuous flow of oxygen will flow through the cannula and into your nose. The oxygen is measured in Liters per Minute or LPM.

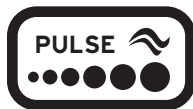

PULSE FLOW MODE

In Pulse Flow Mode the device will detect your breath and supply a measured pulse of oxygen or bolus. The breath detect icon will flash on the control panel with each breath.

AT HIGHER FLOW SETTINGS YOU MAY NOTICE THE MOTOR REVVING WHICH IS NORMAL AND NECESSARY TO ACHIEVE MAXIMUM OXYGEN OUTPUT.

PULSE MODE BOLUS VOLUMES

Pulse Mode Setting	Bolus Volume (mL)
0.5	8
1.0	16
1.5	24
2.0	32
2.5	40
3.0	48
3.5	56
4.0	64
4.5	72
5.0	80
5.5	88
6.0	96

IF NO BREATH IS DETECTED FOR 45 SECONDS THE DISPLAY SCREEN WILL TURN YELLOW AND THE DEVICE WILL BEEP ONCE. IF NO BREATH IS DETECTED FOR AN ADDITIONAL 15 SECONDS THE DEVICE WILL DEFAULT TO THE PREVIOUS CONTINUOUS FLOW MODE SETTING.

HANDLE OPERATION

OPEN/CLOSE Press button to unlock handle.
Begin rotating and release button, handle will re-lock
in open/close position automatically.

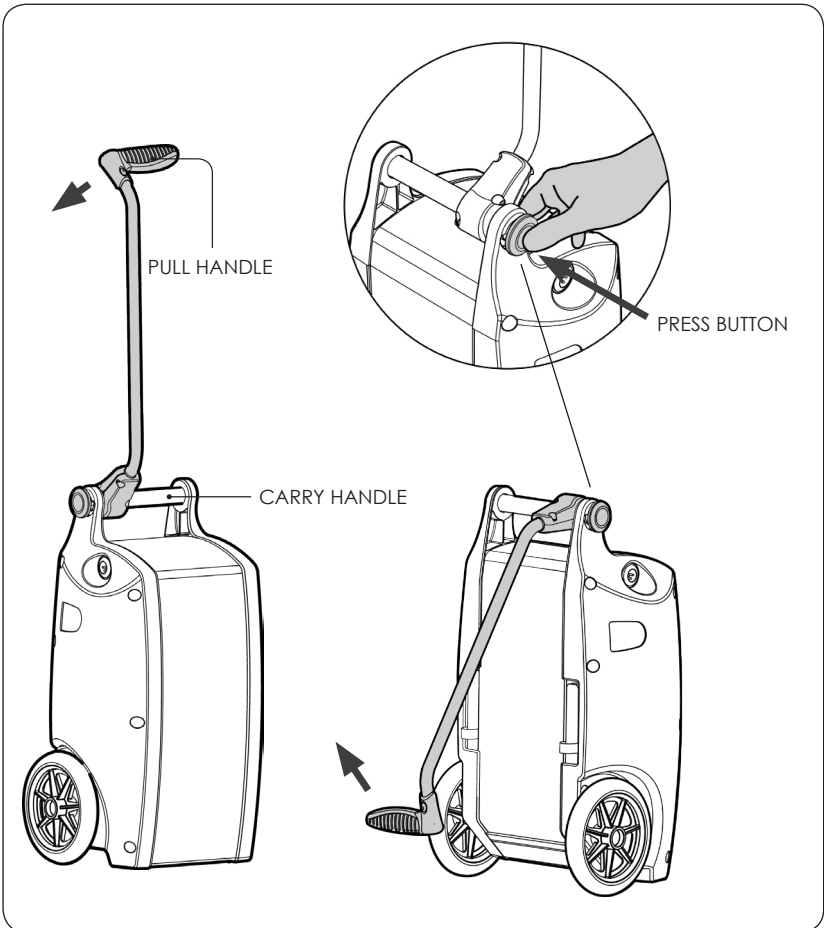

HANDLING

CAUTION !

! DO NOT LEAN ON UNIT

To prevent damage to the unit, avoid resting excessive weight on handle.



CAUTION !

! STAIRS

While transporting the unit down stairs, it is recommended to allow unit to travel down first.



CANNULA USE

WARNING

 Use of a cannula not specified for use with oxygen may impair the performance of your device.

 **DO NOT** use cannula tubing longer than 7 feet when using Pulse Flow Mode.

 **DO NOT** use cannula tubing longer than 50 feet when using Continuous Flow Mode. Your physician will prescribe the appropriate cannula for your use.

- Connect the cannula to the oxygen outlet port as shown on adjacent page. The cannula fitting may be tight.
- **DO NOT** use grease or oils to lubricate the oxygen outlet port.

- Read and follow the instructions included with the cannula, and follow the instructions given by your authorized dealer.
- Place the cannula over your ears and position the cannula prongs in your nose.
- Clean and replace your cannula regularly as instructed by your authorized dealer.

OXYGEN OUTLET PORT

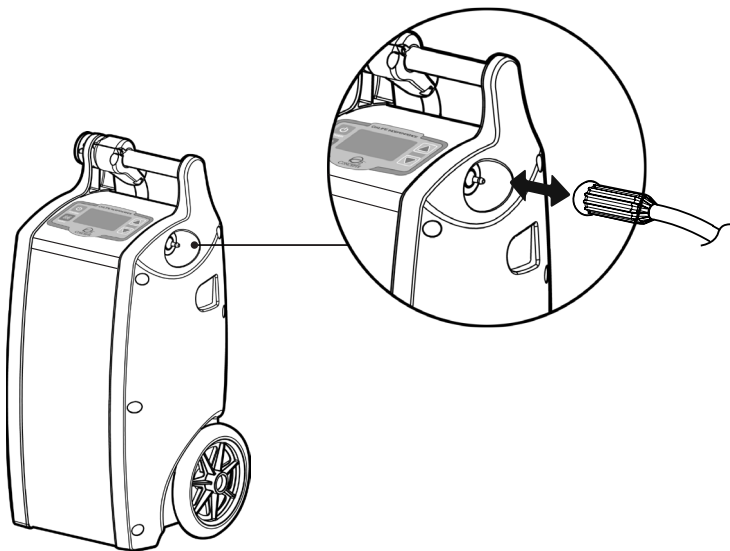

TROUBLESHOOTING GUIDE

ALERT/ALARM CONDITION	DEVICE STATUS	SOLUTION
LOW BATTERY ALERT	When battery charge status reaches 10%, the screen will turn yellow and "ALERT LOW BATTERY" will be displayed in the System Status window. The device will beep every 30 seconds and then go into Low Battery Alarm mode.	Plug into an external power source. OR Replace depleted battery (batteries) with a charged battery.
LOW PURITY ALERT	If Oxygen Purity drops below 85% the screen will turn yellow and "ALERT LOW PURITY" will be displayed in the System Status window. The device will beep once every 30 seconds until the condition is corrected.	Clean or replace air inlet filter. Contact your authorized dealer.
NO BREATH DETECTED	If no breath is detected for 45 seconds the screen will turn yellow and "ALERT NO BREATH" will be displayed in the System Status Window. The device will beep once. If no breath is detected for an additional 15 seconds, the device will default to the previous Continuous Flow Setting selected.	Ensure cannula tubing does not exceed 7 feet (2.1m). Note: No Breath Detected is used when in Pulse Flow Mode ONLY.
LOW BATTERY ALARM	When the battery is depleted, the screen will turn red and "LOW BATTERY" will be displayed in the System Status window. The device will beep for 15 seconds before shutting down.	Plug into an external power source. Replace depleted battery (batteries) with a charged battery.
LOW PURITY ALARM	If Oxygen Purity drops below 72% the screen will turn red and "LOW PURITY" will be displayed in the System Status window. The device will beep for 15 seconds before shutting down.	Repair or replace tubing or humidifier. Clean or replace air inlet filter. Contact your authorized dealer.
NO EXTERNAL POWER ALARM	If no external power source is detected, the screen will turn red and "NO EXTERNAL POWER" will be displayed in the System Status window. The device will beep every second for 10 minutes before shutting down.	Ensure all charging connections are intact. In the case of an extended power outage, utilize an alternate, non-powered, source of oxygen.
NO FLOW ALARM	If no oxygen flow is detected, the screen will turn red and "NO FLOW" will be displayed in the System Status window. The device will beep for 15 seconds before shutting down.	Check cannula connection. Repair or replace tubing or humidifier. Clean or replace air inlet filter. Move device to ensure adequate air flow. Contact your authorized dealer.
OVER TEMPERATURE ALARM	If the device is too hot to operate safely, the screen will turn red and "OVER TEMPERATURE" will be displayed in the System Status window. The device will beep for 15 seconds before shutting down.	Allow the device to reach operating temperature. Utilize an alternate source of oxygen if necessary.
SERVICE REQUIRED ALARM	If service is required for the device to operate safely, the screen will turn red and "SERVICE REQUIRED" will be displayed in the System Status window. The device will beep for 15 seconds before shutting down.	Contact your authorized dealer and utilize an alternate supply of oxygen.
UNAUTHORIZED BATTERY ALARM	If the device detects that an unauthorized battery has been installed, the screen will turn red and "UNAUTHORIZED BATTERY" will be displayed in the System Status window. The device will shut down.	Remove unauthorized battery and replace with an authorized American Medical Sales and Repair battery.

ALERT AND ALARM SCREENS

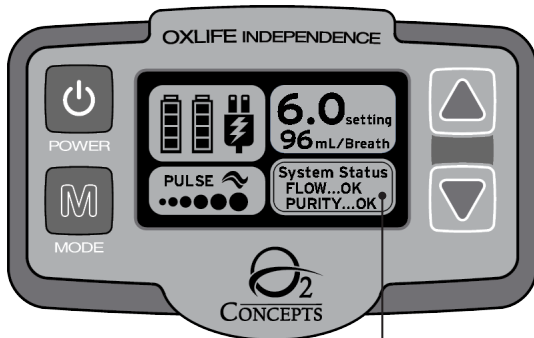

ALERTS AND ALARMS WILL BE INDICATED IN THE LOWER RIGHT SECTION OF THE LCD DISPLAY.

ALARM SCREENS

(RED SCREEN)

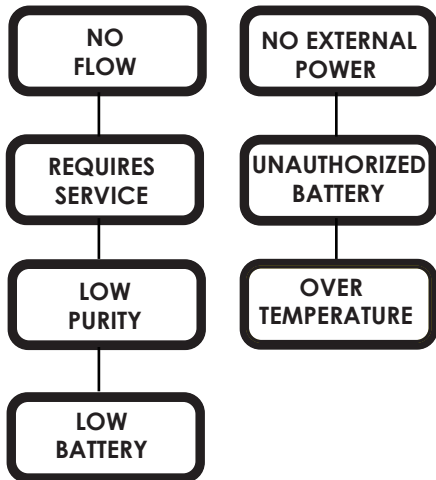

ALERT SCREENS

(YELLOW SCREEN)



MAINTENANCE

- All maintenance **MUST** be conducted by a qualified Oxlife Independence service technician.
DO NOT attempt to disassemble or perform any maintenance on your device. Any such attempt will void the warranty.

USER CARE AND CLEANING

CASE, AC POWER SUPPLY, DC POWER SUPPLY

WARNING A

⚠ Unplug your Oxlife Independence and or power supplies before cleaning.

⚠ **DO NOT** use alcohol, ethylene chloride or petroleum based cleaners on the case or power supplies.

- Clean the outside case of your device using a soft cloth dampened with a mild detergent and water.
DO NOT spray the case.

AIR INLET FILTER CLEANING

- Regular cleaning of the Air Inlet Filter is the only maintenance you will perform on your device. To keep your Oxlife Independence working properly, it is recommended you clean the Air Inlet Filter weekly.
- If the Oxlife Independence is used in a dusty environment, more frequent cleaning of the Air Inlet Filter may be required.
- Never use your Oxlife Independence without an Air Inlet Filter.

AIR INLET FILTER CLEANING (CONT.)

Follow these simple directions to clean the Air Inlet Filter:

1. Remove the Air Inlet Filter
2. Wash the filter by running under warm tap water using a mild detergent.
3. Rinse thoroughly under warm, running water.
4. Squeeze out excess water.
5. It is important to allow the filter to dry completely before reinserting into the device. Moisture from a wet or damp Air Inlet Filter may damage your device.

! You may want to keep an extra Air Inlet Filter to use as a replacement while one is drying.

Contact your authorized dealer for extra Air Inlet Filters.

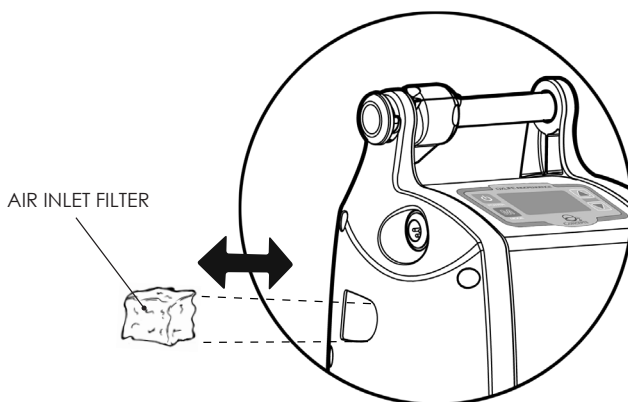

CAUTION **!**

ACCESSORY BAG

The Accessory Bag is designed to carry your Oxlife Independence accessories including batteries, AC charger and cable, and DC charger.

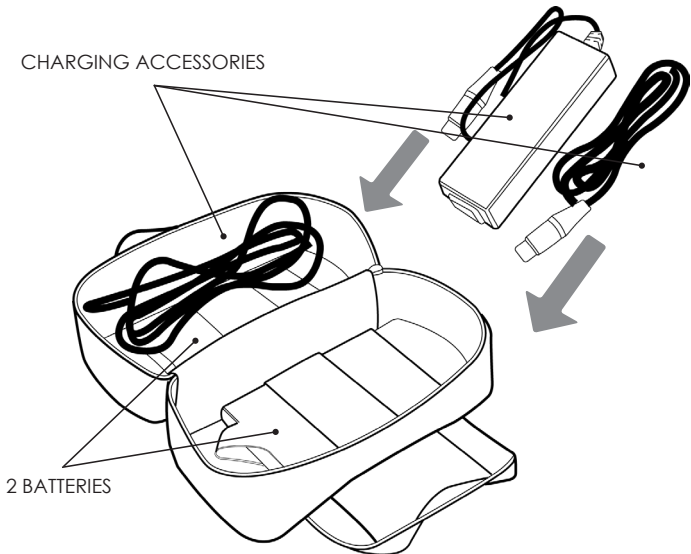

BATTERY DISPOSAL

- Your battery is rechargeable and can be recycled. Always return to your authorized dealer for proper disposal. You can also contact your local city or town offices for proper disposal instructions for a lithium ion battery.

DEVICE DISPOSAL

- This product may contain substances that could be harmful to the environment if disposed of in landfills that are inappropriate. Follow local governing ordinances and recycling plans regarding disposal of the device.

NOTES

Oxlife **INDEPENDENCE**