



Set-Top Box & Remote

KSTB2100

KAONMEDIA



|| User Installation Guide ||

Rev.230221

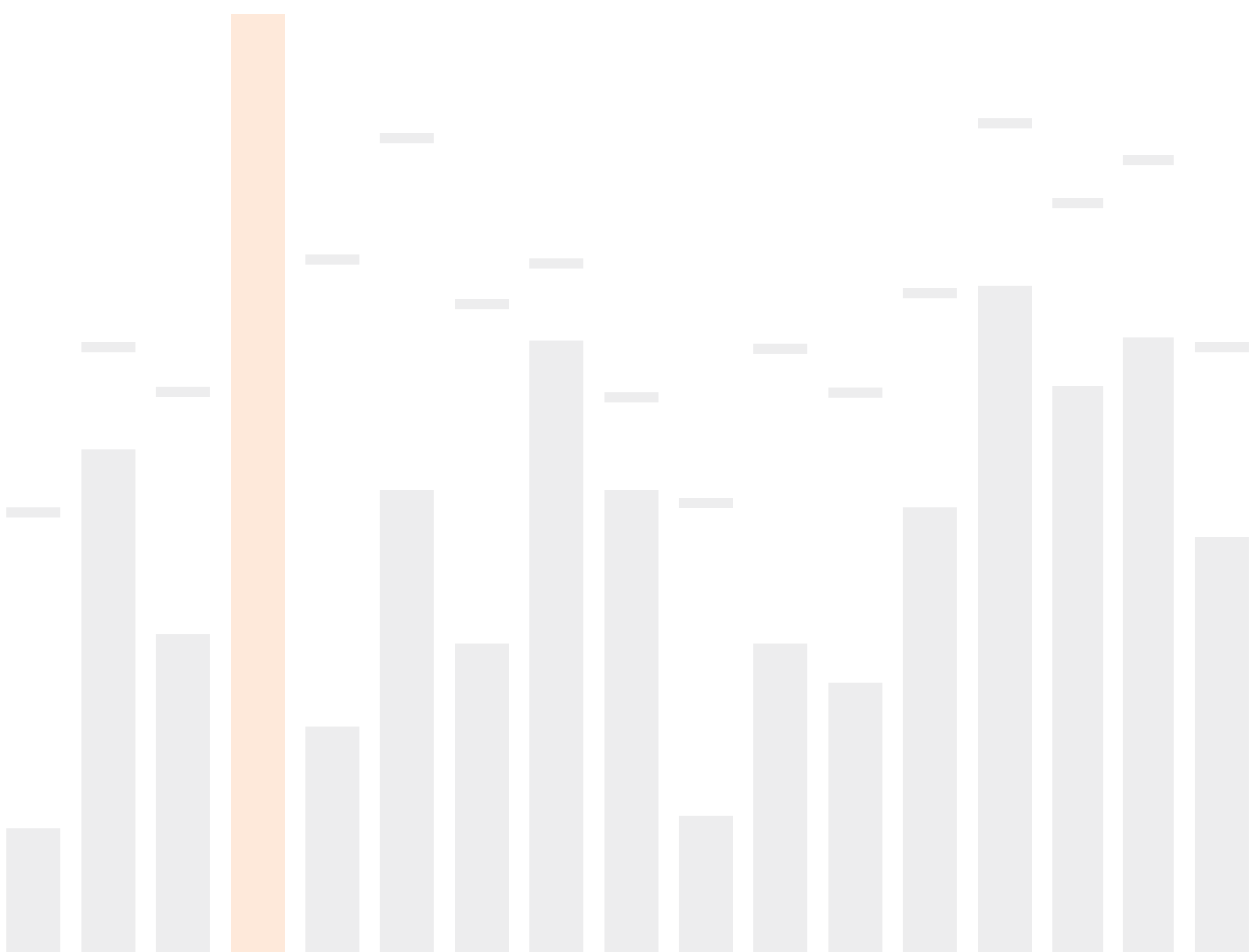

TABLE OF CONTENTS

| | |
|--|-----------|
| WHAT'S IN THE BOX? _____ | 3 |
| SET-TOP BOX AT A GLANCE _____ | 4 |
| BUTTON FUNCTIONALITY _____ | 6 |
| SELF-INSTALL PHYSICAL PLACEMENT GUIDELINES _____ | 7 |
| SELF-INSTALL CONNECTION GUIDELINES _____ | 8 |
| INITIAL BOX POWER ON _____ | 12 |
| NETWORK SETUP _____ | 18 |
| SERVICE VALIDATION _____ | 19 |
| TROUBLESHOOTING _____ | 20 |
| APPENDIX A : TV Codes for Remote Pairing _____ | 21 |
| APPENDIX B : Audio System Codes for Remote Pairing _____ | 33 |

Google, Android, YouTube, Android TV and other marks are trademarks of Google LLC

This item incorporates copy protection technology that is protected by U.S. patents and other intellectual property rights of Rovi Corporation. Reverse engineering and disassembly are prohibited.



Manufactured under license from Dolby Laboratories. Dolby, Dolby Audio, and the double-D symbol are trademarks of Dolby Laboratories.



The Adopted Trademarks HDMI, HDMI High-Definition Multimedia Interface, and the HDMI Logo are trademarks or registered trademarks of HDMI Licensing Administrator, Inc. in the United States and other countries.

<FCC User manual Statements>

This device complies with Part 15 of the FCC Rules. Operation is subject to the following two conditions:

(1) this device may not cause harmful interference, and

(2) this device must accept any interference received, including interference that cause undesired operation.

FCC Part 15.105 statement

This equipment has been tested and found to comply with the limits for a Class B digital device, pursuant to part 15 of the FCC Rules. These limits are designed to provide reasonable protection against harmful interference in a residential installation. This equipment generates, uses and can radiate radio frequency energy and, if not installed and used in accordance with the instructions, may cause harmful interference to radio communications. However, there is no guarantee that interference will not occur in a particular installation. If this equipment does cause harmful interference to radio or television reception, which can be determined by turning the equipment off and on, the user is encouraged to try to correct the interference by one or more of the following measures:

-Reorient or relocate the receiving antenna.

-Increase the separation between the equipment and receiver.

-Connect the equipment into an outlet on a circuit different from that to which the receiver is connected.

-Consult the dealer or an experienced radio/TV technician for help.

FCC Part 15.21 statement

Any changes or modifications not expressly approved by the party responsible for compliance could void the user's authority to operate this equipment.

RF Exposure Statement(MPE)

The antenna(s) must be installed such that a minimum separation distance of at least 20 cm is maintained between the radiator (antenna) and all persons at all times. This device must not be co-located or operating in conjunction with any other antenna or transmitter.

WHAT'S IN THE BOX?



KSTB2100
Set-Top Box (STB)



HDMI Cable



Power Adapter



Kaon Voice
Classic RCU



AA Batteries



RCA Analog Composite
Breakout Cable
(Optional)

SET-TOP BOX AT A GLANCE

| Perspective View |



1 Power Button
Used to power the Kaon STB
On or Off.

2 Status Indicator LED
Indicates power status of STB
(Red = Off, Green = On).

3 Infrared (IR) Sensor
Used to communicate with the
KURV Remote Control.

| Rear View |



4 AV Out

SD Analog A/V output, used to connect to older-style TVs that do not support HDMI connections. Ask your installer for an RCA composite breakout cable if one was not included.

5 RJ45

10/100 Ethernet port used to connect to a home router.

6 HDMI

Digital A/V output, used to connect to a TV via HDMI cable.

7 S/PDIF

Optical Audio output, used to connect to external Sound bar or Surround Sound system. An optical cable with TOSLINK connectors is required (not included).

8 USB

This port has an output power capability of 5V DC @ 1 amp.

9 12V/1.5A In

DC Power port, used to connect via the power adapter.

BUTTON FUNCTIONALITY



- | | |
|----------------------|-------------------------|
| 1 TV ON | 12 Google Assistant |
| 2 TV/STB ON | 13 Volume Up |
| 3 Fast Backward | 14 Mute |
| 4 Play/Pause | 15 Volume Down |
| 5 Fast Forward | 16 CH UP |
| 6 TV Guide | 17 Last Channel Watched |
| 7 Live TV | 18 CH Down |
| 8 OK | 19 Menu |
| 9 Up/Down/Left/Right | 20 Device Input |
| 10 Return | 21 Remote Set |
| 11 Home | 22 Number Pad |

SELF-INSTALL PHYSICAL PLACEMENT GUIDELINES

The KSTB2100 set-top box should be placed in a location away from direct or indirect heat sources.

Remote Operating in IR Mode

With the remote operating in IR mode, it is recommended that the KSTB2100 be placed in sight for the end user. The IR sensor is in center of the front face plate.

Remote Operating in RF4CE Mode

With the remote operating in RF mode, the KSTB2100 may be placed out of sight. This may include behind a wall-mounted TV or in a TV cabinet.



USAGE CONSTRAINTS

External DVR via USB Drive

The USB port cannot be used to connect an external USB drive to support local DVR capability.

SELF-INSTALL CONNECTION GUIDELINES

HDMI Cable Connection

The USB port cannot be used to connect an external USB drive to support local DVR capability.

What You Need

- An HD or Ultra High Definition (UHD) TV that can support 720p, 1080p or 4K UHD.
- A Broadband Internet connection that supports a wired or WiFi wireless home network (802.11 g, n, or ac).
- Pay TV Operator login credentials (mandatory).
- Google login credentials (optional).

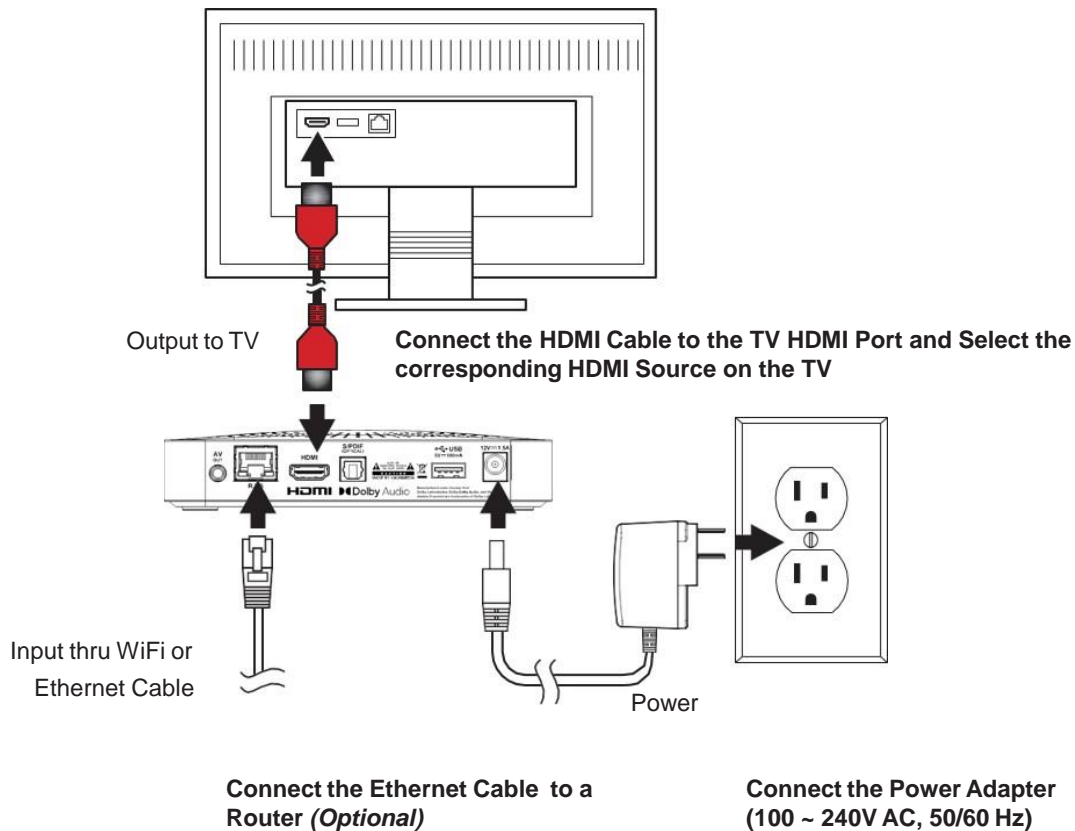

Analog Composite Breakout Cable Connection

Connect the analog composite cable as shown below. This connection scheme should only be used if the TV does not have a working HDMI port.

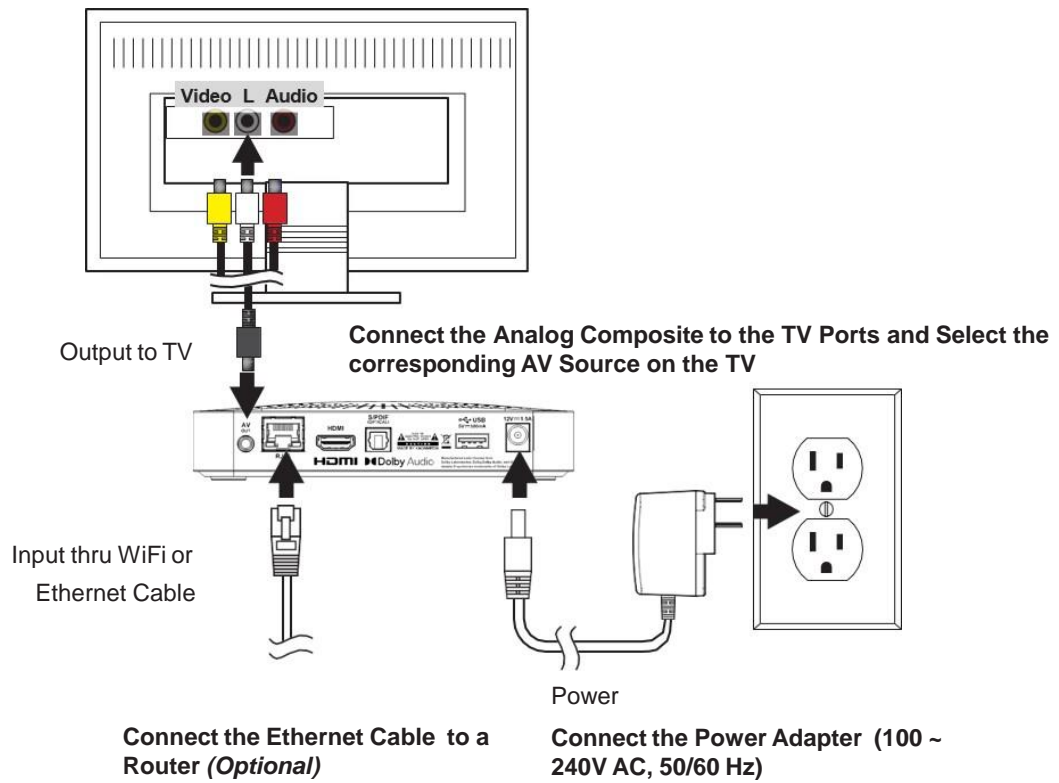

Network Connection

You must connect your new STB to an internet connection through either a WiFi wireless connection or a wired Ethernet connection.

Wired Network Connection

If your home router is near the STB location, a CAT-5/5e/6 Ethernet cable may be used for internet connectivity. Plug one end of the CAT-5/5e/6 cable into the STB RJ45 port. Plug the other end of the cable into any LAN port of your home router.

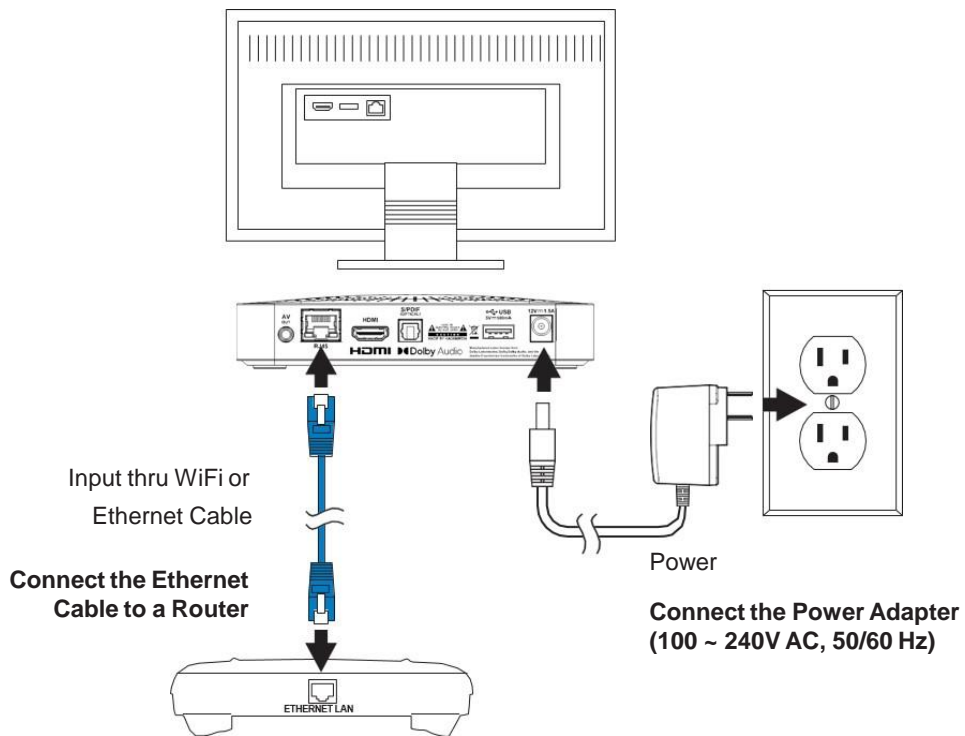

WiFi Network Connection



Connect Automatically Using WPS

Navigate to the main menu by pressing the following key sequences:

 Home →  Settings →  Network →  WiFi → Select to enable.

Once WiFi has been enabled, using the remote scroll down and select "Connect via WPS".

Once selected press the WPS button on your home router. The Set-Top Box will automatically connect to the WiFi network.



Ensure that WiFi network signal strength is strong  or very strong .

Connect Manually

If your home WiFi router does not have a WPS button, you can connect manually. Navigate to the main menu by pressing the following key sequences:

 Home →  Settings →  Network →  WiFi → Select to enable.

Once WiFi has been enabled, using the remote scroll down and select the required network and press OK. When prompted, enter your WiFi password using the remote. Alternately a USB keyboard may be plugged into the USB port of the Set-Top Box. Type password on keyboard as required.

Ensure that WiFi network signal strength is strong  or very strong .

INITIAL BOX POWER ON

The following screens describe the remote key sequences required to setup the KSTB2100. When powered up and fully booted, the box will start on this screen.

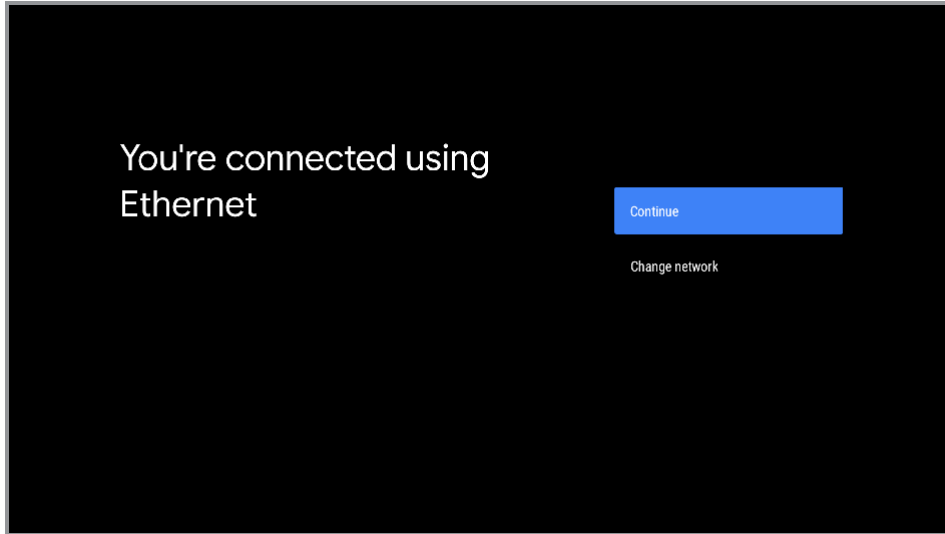

Select **Skip** and press **OK** to continue. The following screen will be displayed.

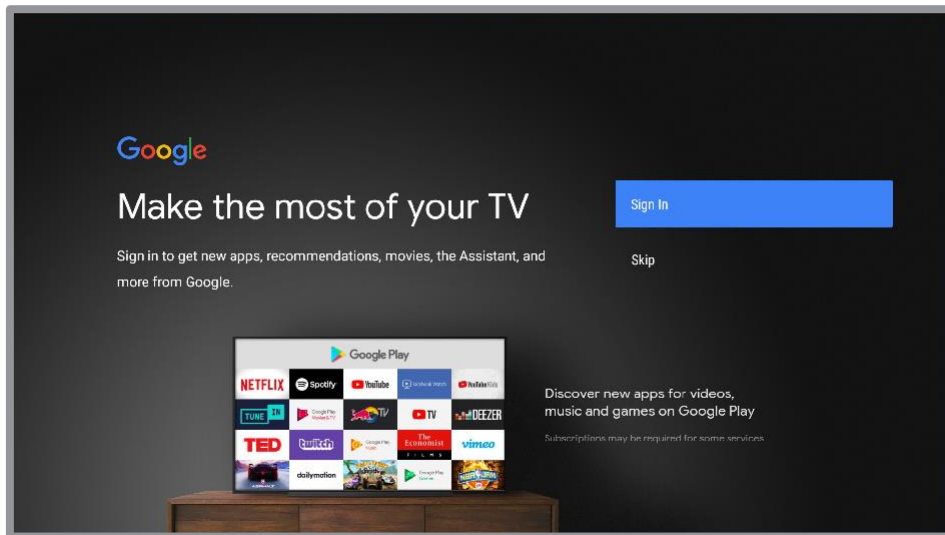

If the end user wishes to login with their Google ID they may do so at this point. If not, select **Skip** and press **OK** to continue.

Once logged in, the following Terms of Service screen will be displayed.
Select Accept and press OK to continue.

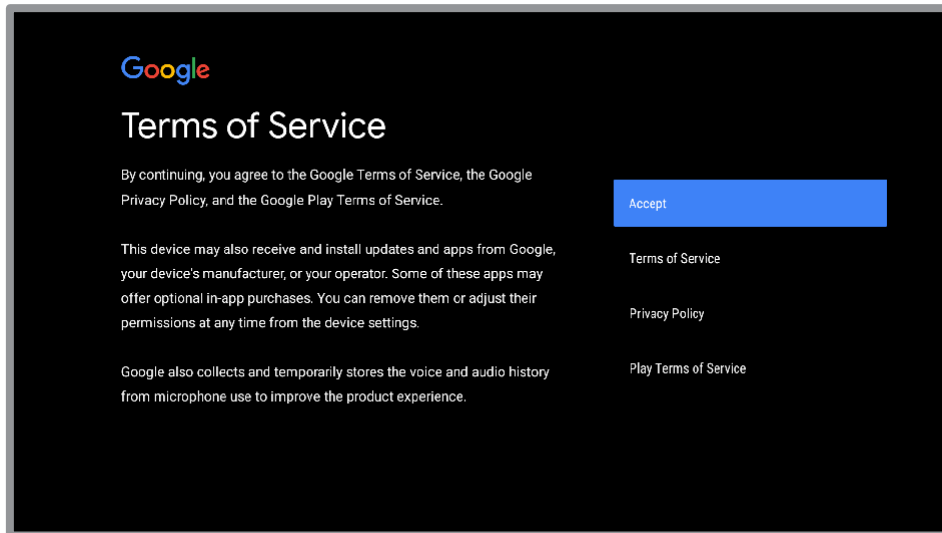

Select Yes on the Location screen and press OK to continue.

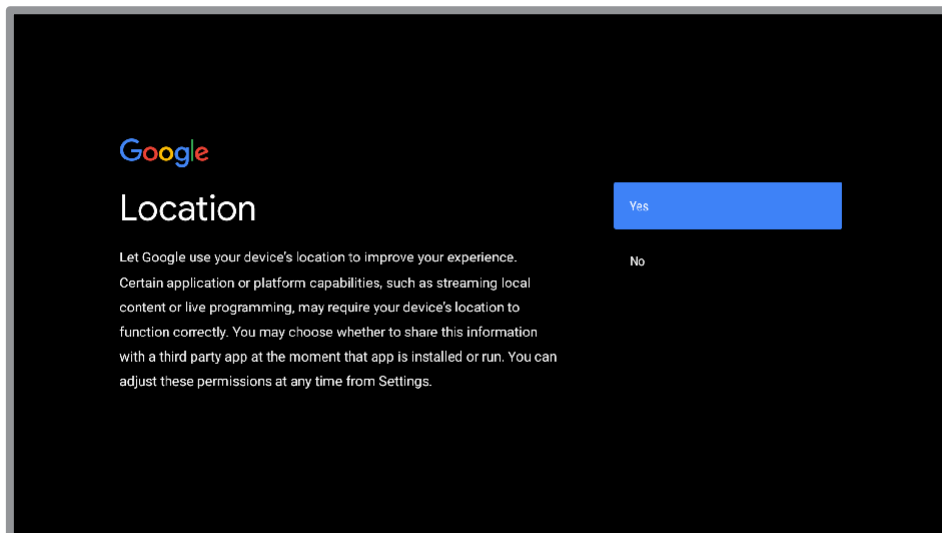

On the Help Improve screen, select **Yes** and press **OK** to continue.

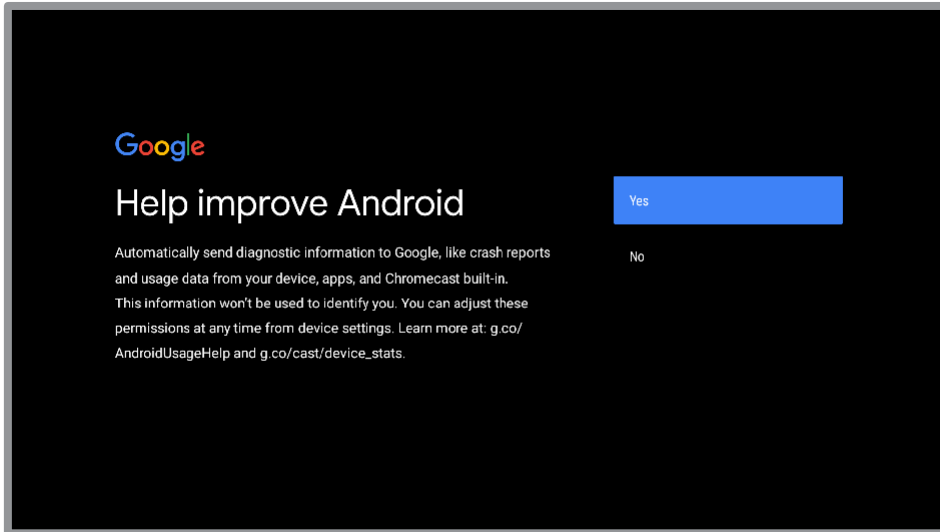

On the Choose a Name screen, select the appropriate name for the unit and press **OK** to continue.

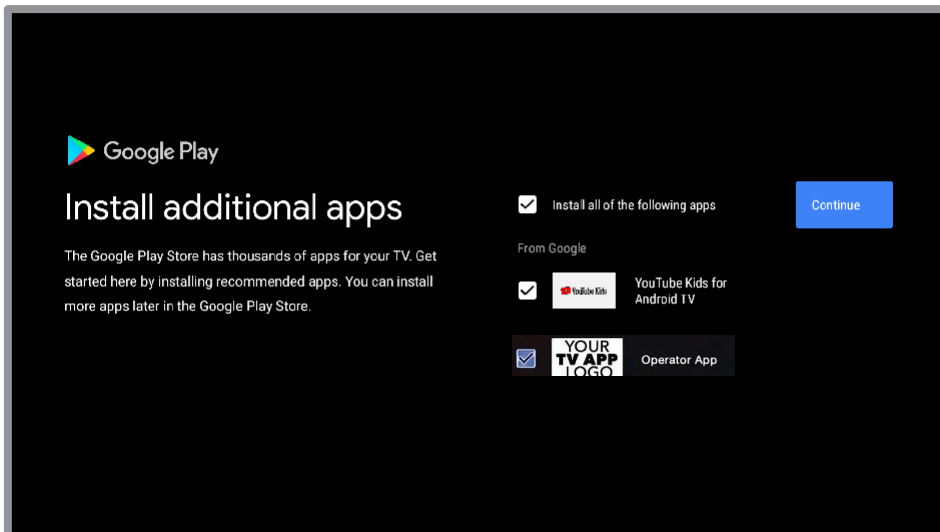

The following Get Started screen will display the login where your Cable Provider App will be located. This app cannot be unselected. Select **Continue** and press **OK** to get to the next screen.

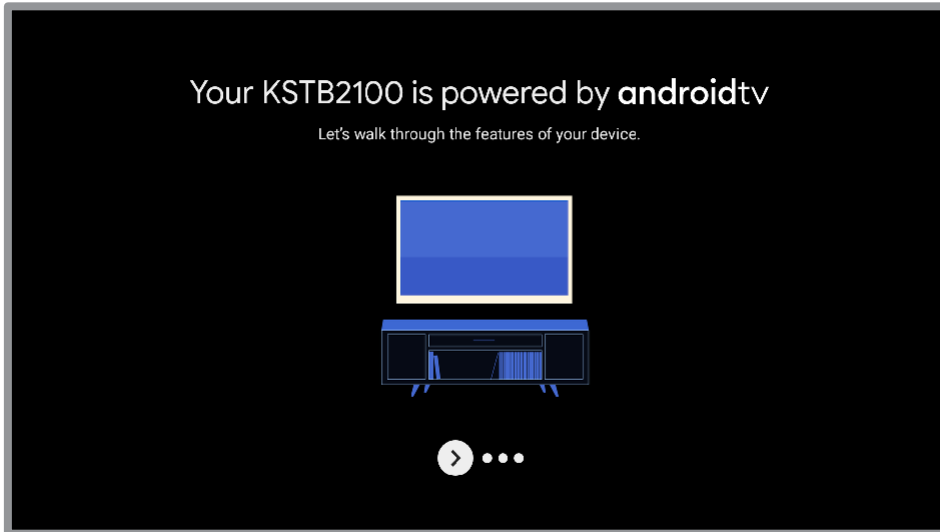

On the Welcome screen, arrow right five times to get to the next screen.

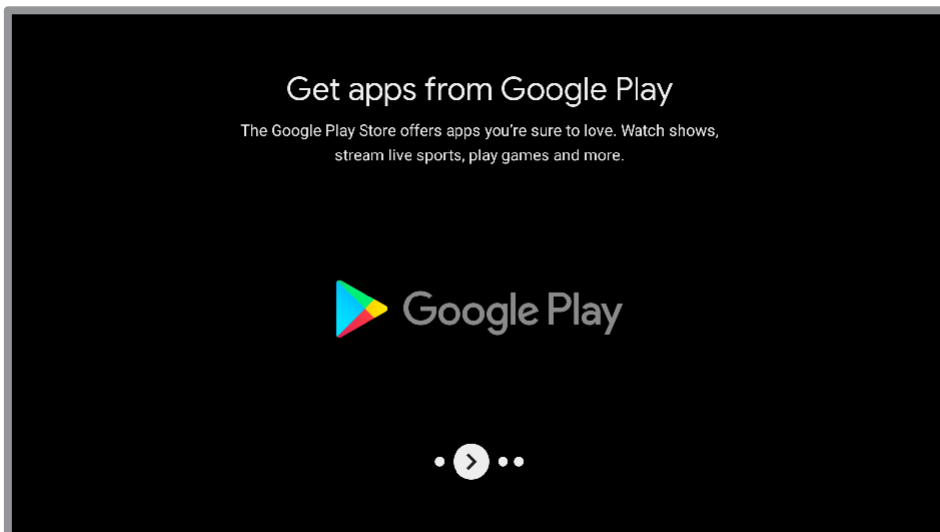

Select **Done** and press **OK** to continue.

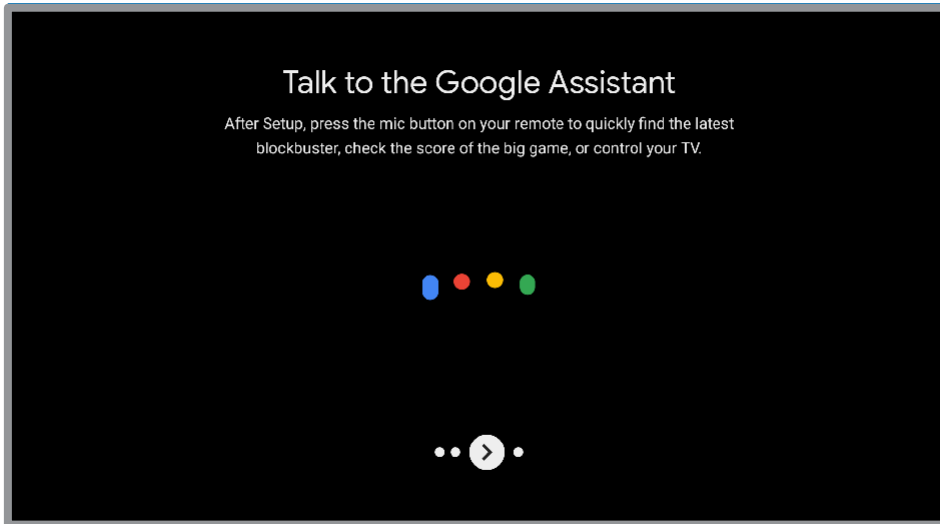

When it is finished processing, the Login screen will be displayed.

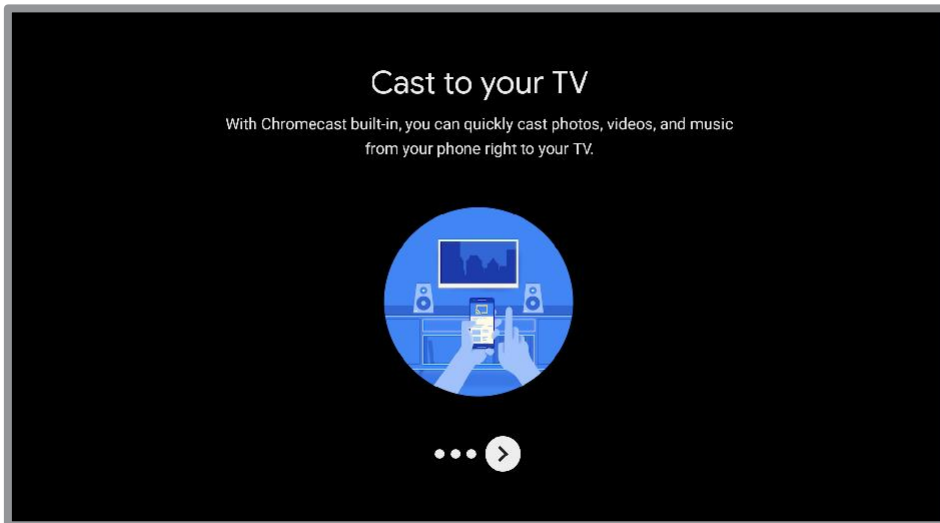

An example login screen is shown. This will be unique for each subscriber. Credentials may be entered using the remote or via a USB keyboard (recommended)

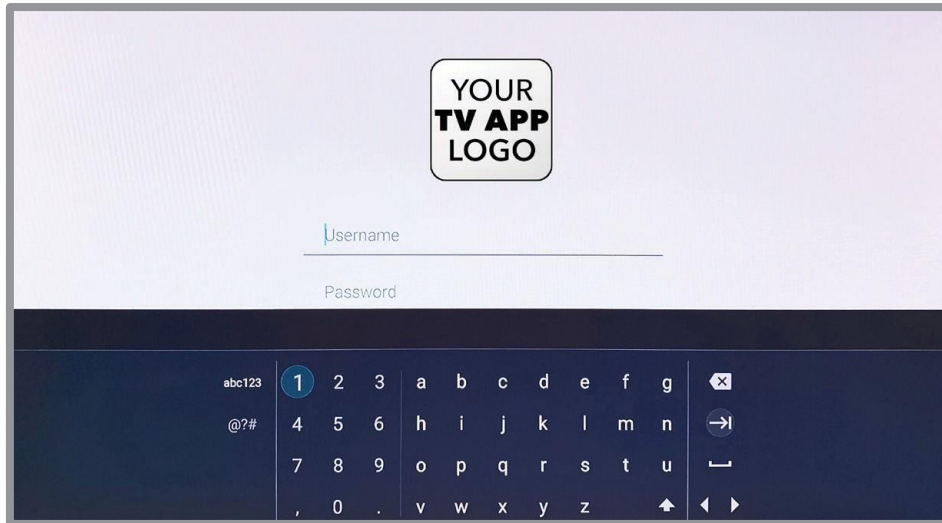

NETWORK SETUP



Wi-Fi Requirements

Navigate to the main menu by pressing the following key sequences:

 Home →  Settings →  Network →  WiFi → Select to enable.

Once WiFi has been enabled, using the remote scroll down and select "Connect via WPS".

Once selected press the WPS button on your home router. The Set-Top Box will automatically connect to the WiFi network.



Ensure that WiFi network signal strength is strong  or very strong .

Connect Manually

If your home WiFi router does not have a WPS button, you can connect manually. Navigate to the main menu by pressing the following key sequences:

 Home →  Settings →  Network →  WiFi → Select to enable.

Once WiFi has been enabled, using the remote scroll down and select the required network and press OK. When prompted, enter your WiFi password using the remote. Alternately a USB keyboard may be plugged into the USB port of the Set-Top Box. Type password on keyboard as required.

Ensure that WiFi network signal strength is strong  or very strong .

SERVICE VALIDATION

RCU/STB Operation

Once STB has been installed and credentials have been entered, the user should confirm that remote works as expected with STB. The user should check the following buttons for correct operation.

- Volume up/down
- Channel up/down
- Menu
- Home
- Guide
- Shows
- Movies

General Video Quality



User should validate that overall video quality is as expected. If possible, tune to a channel with fast moving scenes (e.g. football or hockey game).

Signal Strength Validation

Signal strength may be checked via the network sub-menu in the main menu.

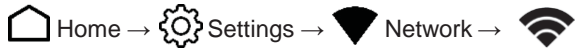
Using the remote and menu navigate to the following:



Ensure that WiFi network signal strength is strong  or very strong .

TROUBLESHOOTING

| Observation | Things to Check | Remediation |
|--|---|---|
| Video/audio quality is poor on STB or network connection error is displayed. | <p>WiFi signal strength in STB Network connection menu.</p> <p>Ideal for consistent video:</p> <ul style="list-style-type: none"> 📶 Strong WiFi signal 📶 Very Strong WiFi signal <p>Video may buffer frequently or will not be consistent:</p> <ul style="list-style-type: none"> 📶 Weak WiFi signal 📶 Medium WiFi signal | <p>Relocate router and STB closer in proximity with each other if possible, such that signal is strong or very strong.</p> <p>Connecting the STB to home router with a CAT-5/5e/ cable will also resolve poor WiFi connectivity issues.</p> <p>If video or audio quality is still poor after correcting network, contact your cable provider technical support.</p> |
| | Ethernet cable integrity | If wired Ethernet connectivity is used, reset/replace Ethernet cable as required. |
| | Router integrity | Power cycle STB and router. |
| | HDMI/Analog composite cable integrity and connection. | Reset/replace cables as needed. |
| | TV HDMI port integrity. | Use different TV HDMI port if possible. |
| | If possible, compare suspect STB A/V quality to another device such as a Blu-ray player. | If the STB is found to show issues while no other devices do, contact your cable provider technical support. |
| Video is not visible on the TV. | HDMI port connection is aligned with the TV's HDMI port selection. | Ensure HDMI port connection and HDMI port selection are the same. |
| Remote does not control STB, TV, or audio equipment. | Battery charge | Replace batteries if charge is low. |
| | Remote is not programmed to TV or Audio system. | Refer to pages 8 or 12 for KURV remote pairing instructions. |
| | A Remote Control button press always lights up the LED at the top of the remote. Red = an IR command sent. Green = an RF command sent. | If NO LED lights on button presses, the batteries should be changed. |

APPENDIX A

TV Codes for Remote Pairing - Top 10 US TV Brands -

| TV Maker/ Brand | Code Number | | | | | | | | | | |
|-----------------|-------------|-------|-------|-------|-------|-------|-------|-------|-------|-------|-------|
| SAMSUNG | 10305 | 10265 | 10001 | 10012 | 10051 | 10092 | 10011 | 10118 | 10124 | 10132 | 10145 |
| | 10176 | 10221 | 10306 | 10542 | 10315 | 10439 | 10479 | 10408 | 10543 | | |
| LG(GOLDSTAR) | 20069 | 20077 | 20018 | 10192 | | | | | | | |
| SONY | 20008 | 20176 | 20005 | 20025 | 20107 | 20145 | 20090 | 20170 | 20195 | 20209 | 20216 |
| | 20305 | 20446 | | | | | | | | | |
| VIZIO | 20180 | | | | | | | | | | |
| PANASONIC | 20126 | 20014 | 20039 | 20094 | 20194 | 20200 | | | | | |
| SHARP | 20139 | 20058 | 20033 | 20100 | 20132 | 20133 | 20134 | 20127 | | | |
| TOSHIBA | 20155 | 20118 | 20237 | 20255 | | | | | | | |
| DYNEX | 10091 | 10347 | 10366 | | | | | | | | |
| TCL | 10256 | 10371 | 10267 | 10553 | | | | | | | |
| SKYWORTH | 10522 | | | | | | | | | | |

Brand List TV

| TV Maker/ Brand | Code Number | | | | | | | | | | |
|-----------------|-------------|-------|-------|-------|-------|-------|-------|-------|-------|-------|-------|
| 3M | 10368 | | | | | | | | | | |
| A MARK | 10103 | 10132 | 10388 | | | | | | | | |
| ACTION | 10370 | | | | | | | | | | |
| ADMIRAL | 10436 | 10431 | | | | | | | | | |
| ADVENT | 10135 | 10339 | | | | | | | | | |
| ADVENTURA | 10372 | | | | | | | | | | |
| AFTRON | 10373 | | | | | | | | | | |
| AIKO | 10374 | | | | | | | | | | |
| AIWA(R-44A) | 10082 | 10183 | | | | | | | | | |
| AKAI | 10148 | 10160 | 10001 | 10317 | 10318 | 10348 | 10352 | 10542 | 10439 | 10476 | 10517 |
| ALARON | 10376 | | | | | | | | | | |
| ALBATRON | 10377 | | | | | | | | | | |
| AMBASSADOR | 10378 | | | | | | | | | | |
| AMERICA ACTION | 10380 | | | | | | | | | | |
| AMPRO | 10070 | 10164 | 10249 | 10381 | | | | | | | |
| AMSTRAD | 10053 | | | | | | | | | | |
| ANAM | 10045 | 10055 | 10057 | 10076 | 10095 | 10099 | 10103 | 10109 | 10112 | 10143 | 10380 |
| | 10288 | | | | | | | | | | |
| AOC | 10088 | 10363 | 10367 | 10001 | 10011 | 10103 | 10330 | 10439 | | | |
| AOMNI | 10354 | | | | | | | | | | |
| APEX | 10302 | 10303 | 10282 | | | | | | | | |
| APEX DIGITAL | 10303 | 10373 | 10384 | | | | | | | | |
| ARCHER | 10388 | | | | | | | | | | |
| ASTAR | 10390 | | | | | | | | | | |
| ATYME | 10272 | | | | | | | | | | |
| AUDIOVOX | 10345 | 10319 | 10380 | 10374 | 10388 | | | | | | |
| AURORA SYSTEMS | 10391 | | | | | | | | | | |
| AVENTURA | 10311 | | | | | | | | | | |
| AVERA | 10282 | | | | | | | | | | |
| BANG & OLUFSEN | 10554 | 10555 | 10557 | | | | | | | | |
| BELCOR | 10001 | 10011 | 10315 | | | | | | | | |
| BELL & HOWELL | 10393 | | | | | | | | | | |
| BENQ | 10395 | 10396 | | | | | | | | | |
| BLAUPUNKT | 10084 | | | | | | | | | | |

Brand List TV

| TV Maker/ Brand | Code Number | | | | | | | | | | |
|----------------------|-------------|-------|-------|-------|-------|-------|-------|-------|-------|-------|-------|
| BLU:SENS | 10476 | 10455 | 10499 | | | | | | | | |
| BOLVA | 10282 | | | | | | | | | | |
| BRADFORD | 10380 | | | | | | | | | | |
| BRILLIAN | 10398 | | | | | | | | | | |
| BROCKWOOD | 10011 | 10315 | | | | | | | | | |
| BROKSONIC | 10143 | 10166 | 10174 | 10431 | | | | | | | |
| BUSH | 10399 | | | | | | | | | | |
| BYD:SIGN | 10400 | | | | | | | | | | |
| CANDLE | 10001 | 10002 | 10003 | 10011 | 10439 | 10372 | 10543 | | | | |
| CANON | 10402 | 10403 | | | | | | | | | |
| CAPEHART | 10059 | | | | | | | | | | |
| CARNIBALE | 10001 | 10439 | | | | | | | | | |
| CARVER | 10415 | 10405 | | | | | | | | | |
| CASIO | 10406 | 10407 | | | | | | | | | |
| CCE | 10408 | | | | | | | | | | |
| CELEBRITY | 10409 | | | | | | | | | | |
| CELERA | 10303 | | | | | | | | | | |
| CETRONIC | 10045 | | | | | | | | | | |
| CHANGHONG | 10303 | | | | | | | | | | |
| CITIZEN | 10001 | 10002 | 10003 | 10011 | 10045 | 10092 | 10094 | 10132 | 10439 | 10374 | 10372 |
| | 10543 | 10517 | | | | | | | | | |
| CLARION | 10380 | | | | | | | | | | |
| CLASSIC | 10045 | | | | | | | | | | |
| COBY | 10412 | 10011 | 10275 | | | | | | | | |
| COMMERCIAL SOLUTIONS | 10413 | | | | | | | | | | |
| COMPAQ | 10414 | | | | | | | | | | |
| CONCERTO | 10011 | 10543 | | | | | | | | | |
| CONTEC | 10041 | 10045 | 10051 | 10052 | 10380 | | | | | | |
| CORENA SYSTEM | 10301 | 10586 | | | | | | | | | |
| CORONADO | 10132 | | | | | | | | | | |
| CRAIG | 10045 | 10055 | 10157 | 10049 | 10159 | 10380 | 10258 | | | | |
| CROSLEY | 10415 | | | | | | | | | | |
| CROWN | 10045 | 10132 | 10380 | | | | | | | | |
| CURTIS MATHES | 10001 | 10092 | 10011 | 10132 | 10365 | 10413 | 10415 | 10393 | 10319 | 10436 | 10542 |

Brand List TV

| Soundbar Maker/ Brand | Code Number | | | | | | | | | |
|-----------------------------|-------------|--|--|--|--|--|--|--|--|--|
| AMAZON | 20414 | | | | | | | | | |
| APEX | 20425 | | | | | | | | | |
| AUVIO | 20403 | | | | | | | | | |
| BOHM | 20423 | | | | | | | | | |
| BOSE | 20440 | | | | | | | | | |
| DENON | 20428 | | | | | | | | | |
| EMATIC | 20412 | | | | | | | | | |
| GOODMANS | 20438 | | | | | | | | | |
| HAIER | 20433 | | | | | | | | | |
| HARMAN KARDON | 20205 | | | | | | | | | |
| INSIGNIA | 20431 | | | | | | | | | |
| JAMO | 20435 | | | | | | | | | |
| JBL | 20432 | | | | | | | | | |
| JVC | 20430 | | | | | | | | | |
| KLIPSCH | 20421 | | | | | | | | | |
| LG(GOLDSTAR) | 20069 | | | | | | | | | |
| MAXWELL | 20445 | | | | | | | | | |
| MEGACRA | 20402 | | | | | | | | | |
| MEIDONG | 20417 | | | | | | | | | |
| MIGHTY ROCK | 20410 | | | | | | | | | |
| NAKAMICHI | 20443 | | | | | | | | | |
| ONKYO | 20178 | | | | | | | | | |
| ORB AUDIO | 20418 | | | | | | | | | |
| ORBITSOUND | 20413 | | | | | | | | | |
| PHILIPS | 20009 | | | | | | | | | |
| POLK AUDIO | 20439 | | | | | | | | | |
| PRECISION ACOUSTICS | 20424 | | | | | | | | | |
| PROSCAN | 20409 | | | | | | | | | |
| PYLE | 20426 | | | | | | | | | |
| QUAD | 20408 | | | | | | | | | |
| REFLEXION | 20419 | | | | | | | | | |
| RICH SOUND RESEARCH(RSR) | 20405 | | | | | | | | | |
| SAMSUNG | 20304 | | | | | | | | | |
| SANYO | 20429 | | | | | | | | | |

Brand List TV

| TV Maker/ Brand | Code Number | | | | | | | | | | |
|-----------------|-------------|-------|-------|-------|-------|-------|-------|-------|-------|-------|-------|
| EMPREX | 10425 | | | | | | | | | | |
| ENVISION | 10439 | 10358 | 10330 | | | | | | | | |
| ENVIXION | 10001 | | | | | | | | | | |
| EPSON | 10364 | | | | | | | | | | |
| ERAE | 10442 | | | | | | | | | | |
| ESA | 10317 | 10318 | 10311 | | | | | | | | |
| FISHER | 10013 | 10058 | 10393 | | | | | | | | |
| FUJITSU | 10149 | 10228 | 10333 | 10334 | 10376 | | | | | | |
| FUNAI | 10033 | 10045 | 10380 | 10311 | 10376 | 10452 | | | | | |
| FUTURETECH | 10045 | 10380 | | | | | | | | | |
| GATEWAY | 10310 | 10486 | | | | | | | | | |
| GE | 10001 | 10014 | 10015 | 10038 | 10057 | 10070 | 10083 | 10011 | 10121 | 10133 | 10141 |
| | 10145 | 10413 | 10319 | 10315 | 10489 | 10484 | | | | | |
| GILBRALTER | 10001 | 10011 | 10439 | 10315 | | | | | | | |
| GO VIDEO | 10443 | 10479 | 10476 | | | | | | | | |
| GOODMANS | 10445 | | | | | | | | | | |
| GPX | 10276 | | | | | | | | | | |
| GRADIENTE | 10040 | | | | | | | | | | |
| GRUNDIG | 10288 | 10289 | 10575 | 10576 | 10577 | | | | | | |
| GRUNPY | 10380 | 10376 | | | | | | | | | |
| GVA | 10278 | | | | | | | | | | |
| H & B | 10301 | | | | | | | | | | |
| HAIER | 10026 | 10322 | 10323 | 10324 | 10325 | 10326 | 10434 | 10373 | 10067 | 10136 | |
| HALL MARK | 10011 | 10315 | | | | | | | | | |
| HANNS.G | 10447 | | | | | | | | | | |
| HANNSPREE | 10448 | 10449 | 10447 | 10263 | 10264 | | | | | | |
| HARLEY DAVIDSON | 10451 | 10376 | 10452 | | | | | | | | |
| HARMAN KARDON | 10034 | 10180 | 10181 | 10415 | | | | | | | |
| HARVARD | 10380 | 10453 | | | | | | | | | |
| HAVERMY | 10436 | | | | | | | | | | |
| HELIOS | 10301 | | | | | | | | | | |
| HELLO KITTY | 10319 | | | | | | | | | | |
| HEWLETT PACKARD | 10456 | 10330 | 10458 | | | | | | | | |
| HISENSE | 10266 | 10011 | 10279 | 10280 | 10373 | 10459 | 10462 | 10590 | | | |

Brand List TV

| TV Maker/ Brand | Code Number | | | | | | | | | | |
|-----------------|-------------|-------|-------|-------|-------|-------|-------|-------|-------|-------|-------|
| | | | | | | | | | | | |
| HITACHI | 10017 | 10011 | 10015 | 10016 | 10001 | 10018 | 10029 | 10043 | 10072 | 10132 | 10144 |
| | 10147 | 10203 | 10204 | 10206 | 10207 | 10208 | 10210 | 10211 | 10368 | 10452 | 10543 |
| HP | 10357 | | | | | | | | | | |
| HUMAX | 10143 | | | | | | | | | | |
| HYPERION | 10011 | | | | | | | | | | |
| HYUNDAI | 10460 | 10461 | | | | | | | | | |
| I-INC | 10463 | | | | | | | | | | |
| ILO | 10091 | 10343 | 10362 | 10356 | | | | | | | |
| INFINITY | 10415 | 10148 | | | | | | | | | |
| INFOCUS | 10464 | 10364 | 10466 | 10467 | | | | | | | |
| INITIAL | 10356 | | | | | | | | | | |
| INKEL | 10120 | | | | | | | | | | |
| INSIGNIA | 10091 | 10366 | 10311 | 10417 | 10274 | | | | | | |
| JBL | 10148 | 10415 | | | | | | | | | |
| JCPENNY | 10001 | 10011 | 10014 | 10015 | 10030 | 10035 | 10092 | 10132 | 10145 | | |
| JENSEN | 10019 | 10234 | | | | | | | | | |
| JVC | 10261 | 10270 | 10038 | 10040 | 10079 | 10239 | 10550 | | | | |
| KAWASHO | 10470 | | | | | | | | | | |
| KDS | 10335 | | | | | | | | | | |
| KEC | 10045 | 10380 | | | | | | | | | |
| KENWOOD | 10001 | 10229 | 10011 | 10439 | 10315 | | | | | | |
| KLEGG | 10354 | | | | | | | | | | |
| KLH | 10341 | 10303 | | | | | | | | | |
| KLOSS | 10002 | 10060 | 10001 | 10372 | | | | | | | |
| KMC | 10132 | | | | | | | | | | |
| KNOLL SYSTEMS | 10467 | | | | | | | | | | |
| KONKA | 10473 | 10475 | 10476 | 10477 | 10591 | | | | | | |
| KOST | 10478 | 10479 | | | | | | | | | |
| KREISEN | 10480 | 10479 | | | | | | | | | |
| KT | 10001 | 10045 | 10132 | 10140 | 10308 | | | | | | |
| KTV | 10380 | 10439 | | | | | | | | | |
| LG(GOLDSTAR) | 10011 | 10093 | 10103 | 10113 | 10118 | 10132 | 10346 | 10315 | 10439 | | |
| LLOYD'S | 10452 | | | | | | | | | | |
| LODGENT | 10069 | | | | | | | | | | |

Brand List TV

| TV Maker/ Brand | Code Number | | | | | | | | | | |
|--------------------|-------------|-------|-------|-------|-------|-------|-------|-------|-------|-------|-------|
| LOEWE | 10481 | | | | | | | | | | |
| LOGIK | 10069 | | | | | | | | | | |
| LUCE | 10358 | 10483 | | | | | | | | | |
| LUXMAN | 10011 | 10543 | | | | | | | | | |
| LXI | 10013 | 10021 | 10053 | 10034 | 10145 | 10148 | 10413 | 10415 | 10393 | 10303 | 10315 |
| MAGNASONIC | 10001 | 10011 | 10348 | | | | | | | | |
| MAGNAVOX | 10001 | 10003 | 10011 | 10060 | 10061 | 10062 | 10064 | 10065 | 10066 | 10086 | 10088 |
| | 10118 | 10132 | 10145 | 10148 | 10192 | 10212 | 10236 | 10244 | 10312 | 10332 | 10415 |
| | 10439 | 10356 | 10505 | 10452 | 10330 | 10376 | 10126 | | | | |
| MAGNIN | 10484 | | | | | | | | | | |
| MARANTZ | 10001 | 10074 | 10148 | 10415 | 10439 | | | | | | |
| MATSUI | 10148 | | | | | | | | | | |
| MATSUSHITA | 10485 | | | | | | | | | | |
| MAXENT | 10486 | 10487 | | | | | | | | | |
| MB QUART | 10315 | | | | | | | | | | |
| MEGATRON | 10315 | 10368 | 10388 | 10435 | | | | | | | |
| MEMOREX | 10013 | 10069 | 10091 | 10011 | 10393 | 10431 | 10315 | 10376 | 10516 | | |
| METZ | 10084 | | | | | | | | | | |
| MGA | 10001 | 10011 | 10033 | 10044 | 10050 | 10074 | 10315 | 10439 | 10484 | | |
| MIDLAND | 10413 | | | | | | | | | | |
| MINERVA | 10084 | | | | | | | | | | |
| MINTEK | 10356 | | | | | | | | | | |
| MITSUBISHI | 10216 | 10011 | 10030 | 10033 | 10034 | 10041 | 10044 | 10089 | 10115 | 10160 | 10167 |
| | 10168 | 10214 | 10001 | 10245 | 10436 | 10315 | | | | | |
| MONIVISION | 10377 | | | | | | | | | | |
| MONTGOMERY WARD | 10185 | 10217 | 10218 | 10219 | 10220 | | | | | | |
| MOTOROLA | 10436 | 10335 | | | | | | | | | |
| MOXELL | 10335 | | | | | | | | | | |
| MTC | 10001 | 10011 | 10439 | 10315 | 10543 | | | | | | |
| MULTITECH | 10380 | | | | | | | | | | |
| NAD | 10021 | 10031 | 10303 | 10315 | 10543 | | | | | | |
| NAKAMICHI | 10491 | | | | | | | | | | |
| NAXA | 10492 | | | | | | | | | | |
| NEC | 10001 | 10013 | 10022 | 10025 | 10030 | 10041 | 10057 | 10121 | 10125 | 10011 | 10235 |

Brand List TV

| TV Maker/ Brand | Code Number | | | | | | | | | | |
|-----------------|-------------|-------|-------|-------|-------|-------|-------|-------|-------|-------|-------|
| NEC | 10439 | 10315 | 10543 | 10405 | 10344 | | | | | | |
| NETTV | 10486 | | | | | | | | | | |
| NIKEI | 10045 | | | | | | | | | | |
| NIKKO | 10001 | 10315 | 10439 | 10374 | | | | | | | |
| NIKO | 10493 | | | | | | | | | | |
| NOBLEX | 10494 | | | | | | | | | | |
| NORCENT | 10373 | 10330 | 10495 | 10493 | | | | | | | |
| NORWOOD MICRO | 10362 | 10498 | | | | | | | | | |
| NTC | 10374 | | | | | | | | | | |
| NUVISION | 10502 | | | | | | | | | | |
| OLEVIA | 10011 | 10342 | 10535 | 10315 | | | | | | | |
| OLYMPUS | 10503 | | | | | | | | | | |
| ONWA | 10045 | 10380 | | | | | | | | | |
| OPTONICA | 10025 | 10034 | 10235 | | | | | | | | |
| OPTIMUS | 10485 | 10393 | 10504 | 10505 | | | | | | | |
| OPTOMA | 10506 | 10448 | | | | | | | | | |
| OPTONICA | 10436 | | | | | | | | | | |
| ORION | 10431 | 10376 | 10516 | | | | | | | | |
| PANASONIC | 10076 | 10010 | 10038 | 10057 | 10005 | 10148 | 10150 | 10169 | 10308 | 10359 | 10485 |
| PENNEY | 10001 | 10011 | 10413 | 10303 | 10315 | 10439 | 10484 | 10489 | 10388 | 10592 | |
| PHILCO | 10001 | 10003 | 10011 | 10030 | 10045 | 10057 | 10060 | 10061 | 10064 | 10065 | 10118 |
| | 10132 | 10148 | 10415 | 10439 | 10315 | | | | | | |
| PHILIPS | 10148 | 10321 | 10011 | 10040 | 10060 | 10067 | 10132 | 10145 | 10001 | 10222 | 10003 |
| | 10371 | 10415 | 10479 | 10556 | | | | | | | |
| PILOT | 10001 | 10011 | 10439 | 10315 | | | | | | | |
| PIONEER | 10504 | 10024 | 10029 | 10031 | 10032 | 10011 | 10248 | 10254 | 10304 | 10001 | |
| POLAROID | 10335 | 10338 | 10339 | 10340 | 10341 | 10303 | 10417 | 10362 | 10478 | 10301 | 10476 |
| | 10593 | | | | | | | | | | |
| PORTLAND | 10011 | 10132 | 10374 | 10315 | 10335 | 10424 | 10476 | | | | |
| PROSCAN | 10133 | 10249 | 10413 | 10262 | 10257 | 10268 | 10067 | 10269 | 10288 | | |
| PROTON | 10059 | 10011 | 10103 | 10132 | 10165 | 10251 | 10315 | 10388 | | | |
| PROTRON | 10507 | 10508 | | | | | | | | | |
| PROVIEW | 10335 | | | | | | | | | | |
| PULSAR | 10011 | 10315 | | | | | | | | | |

Brand List TV

| TV Maker/ Brand | Code Number | | | | | | | | | | |
|-----------------|-------------|-------|-------|-------|-------|-------|-------|-------|-------|-------|-------|
| PUNEET | 10425 | | | | | | | | | | |
| PVISION | 10442 | | | | | | | | | | |
| QUASAR | 10038 | 10057 | 10243 | 10308 | 10485 | | | | | | |
| RADIO SHACK | 10025 | 10045 | 10048 | 10011 | 10118 | 10132 | 10001 | 10235 | | | |
| RCA | 10001 | 10004 | 10006 | 10011 | 10029 | 10030 | 10057 | 10083 | 10133 | 10145 | 10161 |
| | 10171 | 10232 | 10371 | 10413 | 10484 | 10315 | 10256 | 10272 | 10553 | 10556 | |
| REALISTIC | 10013 | 10025 | 10045 | 10048 | 10001 | 10011 | 10235 | 10393 | 10380 | 10315 | 10439 |
| | 10543 | | | | | | | | | | |
| REVOLUTIONHD | 10354 | | | | | | | | | | |
| ROCTEC | 10237 | | | | | | | | | | |
| RUNCO | 10152 | 10153 | 10001 | 10250 | 10252 | 10336 | 10337 | 10439 | | | |
| SAMPO | 10001 | 10059 | 10011 | 10486 | 10439 | | | | | | |
| SAMSUNG | 10305 | 10265 | 10001 | 10012 | 10051 | 10092 | 10011 | 10118 | 10124 | 10132 | 10145 |
| | 10176 | 10221 | 10306 | 10542 | 10315 | 10439 | 10479 | 10408 | 10543 | | |
| SANSUI | 10431 | 10452 | 10516 | 10517 | | | | | | | |
| SANYO | 10013 | 10026 | 10027 | 10037 | 10041 | 10054 | 10058 | 10078 | 10253 | 10393 | 10402 |
| | 10484 | | | | | | | | | | |
| SCEPTRE | 10313 | 10067 | 10565 | 10136 | | | | | | | |
| SCIMITSU | 10011 | 10315 | | | | | | | | | |
| SCOTT | 10033 | 10045 | 10049 | 10011 | 10132 | 10380 | 10315 | 10376 | | | |
| SCOTCH | 10315 | | | | | | | | | | |
| SEARS | 10011 | 10013 | 10021 | 10033 | 10035 | 10058 | 10078 | 10092 | 10132 | 10145 | 10244 |
| | 10413 | 10415 | 10393 | 10303 | 10315 | 10311 | 10543 | 10376 | 10452 | | |
| SEIKI | 10259 | 10283 | 10284 | 10285 | 10286 | 10287 | | | | | |
| SELECO | 10368 | 10430 | | | | | | | | | |
| SHARP | 10260 | 10020 | 10025 | 10028 | 10033 | 10034 | 10132 | 10151 | 10235 | 10236 | 10361 |
| | 10375 | 10436 | 10011 | 10560 | | | | | | | |
| SHARPER IMAGE | 10518 | | | | | | | | | | |
| SHERWOOD | 10120 | | | | | | | | | | |
| SHOGUN | 10011 | 10315 | | | | | | | | | |
| SIEMENS | 10084 | | | | | | | | | | |
| SIGCUS | 10594 | | | | | | | | | | |
| SIGNATURE | 10069 | 10011 | | | | | | | | | |
| SIGNATURE 2000 | 10011 | | | | | | | | | | |

Brand List TV

| TV Maker/ Brand | Code Number | | | | | | | | | | |
|-------------------|-------------|-------|-------|-------|-------|-------|-------|-------|-------|-------|-------|
| SIGNET | 10519 | 10478 | 10520 | | | | | | | | |
| SIM2 MULTIMEDIA | 10430 | | | | | | | | | | |
| SIMPSON | 10001 | | | | | | | | | | |
| SKYWORTH | 10522 | | | | | | | | | | |
| SODIFF | 10595 | | | | | | | | | | |
| SOLARISM | 10523 | | | | | | | | | | |
| SOLE | 10358 | 10483 | 10301 | 10479 | 10354 | | | | | | |
| SONY | 10043 | 10075 | 10117 | 10130 | 10067 | 10170 | 10238 | 10247 | 10309 | 10409 | 10452 |
| | 10136 | | | | | | | | | | |
| SOUNDESIGN | 10003 | 10033 | 10045 | 10011 | 10380 | 10315 | 10376 | | | | |
| SOVA | 10507 | | | | | | | | | | |
| SOYO | 10425 | 10463 | 10524 | 10525 | 10476 | | | | | | |
| SPECTRICON | 10103 | 10011 | 10388 | | | | | | | | |
| SPECTRONIQ | 10335 | | | | | | | | | | |
| SQUAREVIEW | 10311 | | | | | | | | | | |
| SSS | 10011 | 10045 | 10380 | 10315 | | | | | | | |
| STARLITE | 10011 | 10380 | | | | | | | | | |
| STUDIO EXPERIENCE | 10377 | | | | | | | | | | |
| SUNBRITE | 10528 | 10529 | 10136 | | | | | | | | |
| SUPERSCAN | 10436 | 10530 | | | | | | | | | |
| SUPERSONIC | 10596 | | | | | | | | | | |
| SUPRE MACY | 10002 | 10372 | | | | | | | | | |
| SUPREME | 10409 | | | | | | | | | | |
| SVA | 10373 | 10479 | 10301 | 10532 | 10533 | | | | | | |
| SYLVANIA | 10001 | 10003 | 10008 | 10011 | 10060 | 10061 | 10064 | 10118 | 10126 | 10065 | 10145 |
| | 10148 | 10155 | 10311 | 10355 | 10415 | 10439 | | | | | |
| SYMPHONIC | 10380 | 10311 | 10452 | 10505 | | | | | | | |
| SYNTAX | 10342 | 10535 | 10315 | | | | | | | | |
| TANDY | 10034 | 10436 | | | | | | | | | |
| TASHIKO | 10537 | | | | | | | | | | |
| TATUNG | 10057 | 10063 | 10388 | 10458 | 10362 | | | | | | |
| TCL | 10256 | 10371 | 10267 | 10553 | | | | | | | |
| TEAC | 10379 | 10281 | 10564 | | | | | | | | |
| TECHNICS | 10080 | 10076 | 10485 | | | | | | | | |

Brand List TV

| TV Maker/ Brand | Code Number | | | | | | | | | | |
|-----------------|-------------|-------|-------|-------|-------|-------|-------|-------|-------|-------|-------|
| TECHNOL ACE | 10376 | | | | | | | | | | |
| TECHVIEW | 10539 | 10541 | | | | | | | | | |
| TECHWOOD | 10011 | 10388 | 10543 | | | | | | | | |
| TELEMAGIC | 10402 | | | | | | | | | | |
| TEKNIKA | 10001 | 10002 | 10003 | 10011 | 10030 | 10033 | 10036 | 10045 | 10069 | 10074 | 10092 |
| | 10094 | 10132 | 10415 | 10380 | 10374 | 10315 | 10543 | 10376 | | | |
| TELEFUNKEN | 10039 | 10047 | 10241 | 10242 | 10542 | 10543 | 10544 | | | | |
| TELERENT | 10069 | | | | | | | | | | |
| TERA | 10156 | | | | | | | | | | |
| THOMAS | 10452 | | | | | | | | | | |
| TMK | 10011 | 10315 | 10543 | 10378 | | | | | | | |
| TOSHIBA | 10021 | 10013 | 10035 | 10041 | 10052 | 10063 | 10092 | 10142 | 10146 | 10178 | 10179 |
| | 10393 | 10303 | 10464 | 10419 | 10517 | | | | | | |
| TOTEVISION | 10132 | | | | | | | | | | |
| TRUTECH | 10353 | | | | | | | | | | |
| TVS | 10431 | | | | | | | | | | |
| ULTRA | 10547 | 10508 | | | | | | | | | |
| UNIVERSAL | 10014 | 10015 | | | | | | | | | |
| UPSTAR | 10277 | 10597 | | | | | | | | | |
| US LOGIC | 10362 | | | | | | | | | | |
| VECTOR RESEARCH | 10001 | 10439 | | | | | | | | | |
| VENTURER | 10315 | | | | | | | | | | |
| VICTOR | 10550 | | | | | | | | | | |
| VIDEO CONCEPTS | 10160 | | | | | | | | | | |
| VIDIKRON | 10255 | 10415 | | | | | | | | | |
| VIDTECH | 10011 | 10315 | | | | | | | | | |
| VIEWSONIC | 10363 | 10088 | 10330 | 10331 | 10349 | 10486 | 10530 | 10503 | | | |
| VIKING | 10372 | | | | | | | | | | |
| VIORE | 10316 | | | | | | | | | | |
| VISART | 10551 | | | | | | | | | | |
| VITO | 10360 | | | | | | | | | | |
| VIZIO | 10011 | 10315 | 10351 | 10530 | | | | | | | |
| WARDS | 10011 | 10014 | 10015 | 10025 | 10033 | 10061 | 10062 | 10064 | 10065 | 10069 | 10071 |
| | 10132 | 10148 | 10001 | 10235 | 10415 | 10315 | 10439 | 10489 | 10543 | 10376 | |

Brand List TV

| TV Maker/ Brand | Code Number | | | | | | | | | | |
|---------------------|-------------|-------|-------|-------|-------|-------|-------|-------|-------|-------|--|
| WAYCON | 10303 | | | | | | | | | | |
| WHITE WESTING HOUSE | 10091 | 10319 | 10320 | 10327 | 10328 | 10329 | 10067 | 10431 | 10409 | 10136 | |
| WINBOOK | 10362 | | | | | | | | | | |
| WOOYOUNG | 10307 | | | | | | | | | | |
| WYSE | 10330 | | | | | | | | | | |
| XIAOMI | 10588 | | | | | | | | | | |
| XOCECO | 10552 | | | | | | | | | | |
| YAMAHA | 10001 | 10011 | 10439 | 10315 | | | | | | | |
| YORK | 10011 | | | | | | | | | | |
| ZENITH | 10009 | 10069 | 10070 | 10090 | 10094 | 10431 | 10315 | 10374 | 10452 | 10516 | |
| ZONDA | 10103 | 10388 | | | | | | | | | |

APPENDIX B

Audio System Codes for Remote Pairing Brand List AUDIO

| Audio Maker/ Brand | Code Number | | | | | | | | | | |
|--------------------|-------------|-------|-------|-------|-------|-------|-------|-------|-------|-------|-------|
| ADCOM | 20088 | 20098 | 20218 | 20147 | 20233 | | | | | | |
| AIWA | 20142 | 20182 | 20025 | 20141 | 20022 | 20110 | | | | | |
| AKAI | 20128 | | | | | | | | | | |
| AMAZON | 20414 | | | | | | | | | | |
| ANAM | 20026 | 20188 | 20189 | | | | | | | | |
| ANTHEM | 20004 | | | | | | | | | | |
| APEX | 20425 | | | | | | | | | | |
| AUVIO | 20403 | | | | | | | | | | |
| B&K | 20102 | 20103 | | | | | | | | | |
| BOHM | 20423 | | | | | | | | | | |
| BOSE | 20007 | 20185 | 20131 | 20440 | | | | | | | |
| CARVER | 20253 | 20013 | 20037 | 20060 | 20068 | 20148 | 20221 | 20226 | 20245 | 20250 | 20015 |
| CLARION | 20132 | | | | | | | | | | |
| COBY | 20010 | 20017 | | | | | | | | | |
| DENON | 20041 | 20234 | 20111 | 20149 | 20150 | 20152 | 20232 | 20003 | 20428 | | |
| EMATIC | 20412 | | | | | | | | | | |
| ENLIGHTENED | 20105 | | | | | | | | | | |
| EVERQUEST | 20032 | | | | | | | | | | |
| FISHER | 20037 | 20015 | 20083 | 20207 | | | | | | | |
| FOSGATE AUDIONIC | 20153 | | | | | | | | | | |
| GOODMANS | 20438 | | | | | | | | | | |
| HAIER | 20019 | 20023 | 20433 | | | | | | | | |
| HARMAN KARDON | 20205 | 20208 | 20153 | 20228 | 20229 | 20249 | | | | | |
| HITACHI | 20035 | 20040 | 20027 | 20202 | | | | | | | |
| ILIVE | 20049 | 20050 | 20311 | | | | | | | | |
| INKEL | 20012 | | | | | | | | | | |
| INSIGNIA | 20061 | | | | | | | | | | |
| JAMO | 20435 | | | | | | | | | | |
| JBL | 20432 | | | | | | | | | | |
| JCPENNY | 20016 | 20108 | | | | | | | | | |
| JENSEN | 20065 | | | | | | | | | | |
| JVC | 20112 | 20430 | | | | | | | | | |

Brand List AUDIO

| Audio Maker/ Brand | Code Number | | | | | | | | | | |
|---------------------|-------------|-------|-------|-------|-------|-------|-------|-------|-------|-------|-------|
| KENWOOD | 20012 | 20206 | 20231 | 20033 | 20015 | 20211 | 20212 | 20213 | 20214 | 20215 | 20222 |
| | 20230 | 20134 | 20246 | | | | | | | | |
| KLIPSCH | 20421 | 20437 | | | | | | | | | |
| LEXICON | 20125 | 20156 | 20158 | 20159 | | | | | | | |
| LG(GOLDSTAR) | 20069 | 20077 | 20018 | 20192 | | | | | | | |
| LOTTE | 20191 | 20193 | | | | | | | | | |
| LUXMAM | 20042 | | | | | | | | | | |
| LXI | 20084 | | | | | | | | | | |
| MAGNAVOX | 20013 | 20092 | | | | | | | | | |
| MARANTZ | 20013 | 20093 | 20047 | 20072 | 20063 | 20203 | 20221 | 20250 | | | |
| MAXELL | 20078 | | | | | | | | | | |
| MAXWELL | 20445 | | | | | | | | | | |
| MCINTOSH | 20160 | | | | | | | | | | |
| MCS | 20016 | | | | | | | | | | |
| MEGACRA | 20402 | 20319 | | | | | | | | | |
| MEIDONG | 20417 | | | | | | | | | | |
| MIGHTY ROCK | 20410 | | | | | | | | | | |
| MITSUBISHI | 20164 | 20165 | | | | | | | | | |
| NAD | 20036 | | | | | | | | | | |
| NAKAMICHI | 20167 | 20047 | 20443 | 20450 | 20320 | | | | | | |
| NILES | 20168 | | | | | | | | | | |
| ONKYO | 20178 | 20053 | 20113 | 20114 | 20024 | 20177 | 20179 | 20223 | 20224 | 20251 | |
| OPTIMUS | 20029 | 20033 | 20048 | | | | | | | | |
| ORB AUDIO | 20418 | | | | | | | | | | |
| ORBITSOUND | 20413 | | | | | | | | | | |
| OUTLAW | 20183 | | | | | | | | | | |
| PANASONIC | 20126 | 20014 | 20039 | 20094 | 20194 | 20200 | | | | | |
| PARASOUND | 20254 | | | | | | | | | | |
| PHILIPS | 20009 | 20301 | 20302 | 20303 | 20093 | 20013 | 20172 | 20124 | | | |
| PIONEER | 20082 | 20021 | 20046 | 20051 | 20057 | 20073 | 20076 | 20096 | 20001 | 20054 | 20237 |
| | 20238 | 20239 | 20240 | 20241 | 20242 | 20243 | 20244 | | | | |
| POLK AUDIO | 20439 | | | | | | | | | | |
| PRECISION ACOUSTICS | 20424 | | | | | | | | | | |
| PROCEED | 20006 | 20248 | 20252 | | | | | | | | |

Brand List AUDIO

| Audio Maker/ Brand | Code Number | | | | | | | | | | |
|--------------------------|-------------|-------|-------|-------|-------|-------|-------|-------|-------|-------|-------|
| PROSCAN | 20409 | | | | | | | | | | |
| PYLE | 20426 | 20447 | 20448 | | | | | | | | |
| QUAD | 20408 | | | | | | | | | | |
| QUASAR | 20014 | 20094 | | | | | | | | | |
| RCA | 20062 | 20106 | 20120 | 20138 | 20056 | 20123 | | | | | |
| REALISTIC | 20011 | 20030 | 20084 | 20002 | 20026 | 20101 | | | | | |
| REFLEXION | 20419 | | | | | | | | | | |
| RICH SOUND RESEARCH(RSR) | 20405 | | | | | | | | | | |
| ROTEL | 20089 | 20080 | 20091 | | | | | | | | |
| SAMSUNG | 20304 | 20197 | 20198 | 20199 | 20306 | | | | | | |
| SANSUI | 20116 | 20013 | 20124 | 20047 | | | | | | | |
| SANYO | 20187 | 20429 | | | | | | | | | |
| SCOTT | 20026 | 20097 | | | | | | | | | |
| SENTRY | 20407 | | | | | | | | | | |
| SHARP | 20139 | 20058 | 20033 | 20100 | 20132 | 20133 | 20134 | 20127 | | | |
| SHERWOOD | 20045 | 20031 | 20247 | | | | | | | | |
| SONOS | 20449 | | | | | | | | | | |
| SONY | 20008 | 20176 | 20005 | 20025 | 20107 | 20145 | 20090 | 20170 | 20195 | 20209 | 20216 |
| | 20305 | 20446 | | | | | | | | | |
| SOUNDESIGN | 20043 | | | | | | | | | | |
| SSI | 20075 | | | | | | | | | | |
| TAEKWANG | 20128 | 20186 | 20195 | | | | | | | | |
| TAOTRONICS | 20416 | | | | | | | | | | |
| TEAC | 20066 | 20067 | 20026 | 20190 | | | | | | | |
| TECHNICS | 20126 | 20094 | 20109 | 20014 | 20137 | | | | | | |
| THOMSON | 20217 | | | | | | | | | | |
| TOSHIBA | 20155 | 20118 | 20237 | 20255 | | | | | | | |
| VELODYNE | 20404 | | | | | | | | | | |
| VICTOR | 20020 | 20112 | | | | | | | | | |
| VIZIO | 20180 | | | | | | | | | | |
| VOGELS | 20411 | | | | | | | | | | |
| WARDS | 20015 | | | | | | | | | | |
| YAMAHA | 20140 | 20166 | 20201 | 20028 | 20033 | 20038 | 20074 | 20132 | 20175 | 20204 | 20210 |
| | 20219 | 20220 | 20227 | 20235 | 20236 | 20427 | | | | | |

Brand List AUDIO

| Audio Maker/ Brand | Code Number | | | | | | | | | | | |
|--------------------|-------------|--|--|--|--|--|--|--|--|--|--|--|
| ZANTEK | 20174 | | | | | | | | | | | |
| ZVOX | 20401 | | | | | | | | | | | |

Brand List SOUNDBAR

| Soundbar Maker/ Brand | Code Number | | | | | | | | | |
|-----------------------------|-------------|--|--|--|--|--|--|--|--|--|
| AMAZON | 20414 | | | | | | | | | |
| APEX | 20425 | | | | | | | | | |
| AUVIO | 20403 | | | | | | | | | |
| BOHM | 20423 | | | | | | | | | |
| BOSE | 20440 | | | | | | | | | |
| DENON | 20428 | | | | | | | | | |
| EMATIC | 20412 | | | | | | | | | |
| GOODMANS | 20438 | | | | | | | | | |
| HAIER | 20433 | | | | | | | | | |
| HARMAN KARDON | 20205 | | | | | | | | | |
| INSIGNIA | 20431 | | | | | | | | | |
| JAMO | 20435 | | | | | | | | | |
| JBL | 20432 | | | | | | | | | |
| JVC | 20430 | | | | | | | | | |
| KLIPSCH | 20421 | | | | | | | | | |
| LG(GOLDSTAR) | 20069 | | | | | | | | | |
| MAXWELL | 20445 | | | | | | | | | |
| MEGACRA | 20402 | | | | | | | | | |
| MEIDONG | 20417 | | | | | | | | | |
| MIGHTY ROCK | 20410 | | | | | | | | | |
| NAKAMICHI | 20443 | | | | | | | | | |
| ONKYO | 20178 | | | | | | | | | |
| ORB AUDIO | 20418 | | | | | | | | | |
| ORBITSOUND | 20413 | | | | | | | | | |
| PHILIPS | 20009 | | | | | | | | | |
| POLK AUDIO | 20439 | | | | | | | | | |
| PRECISION ACOUSTICS | 20424 | | | | | | | | | |
| PROSCAN | 20409 | | | | | | | | | |
| PYLE | 20426 | | | | | | | | | |
| QUAD | 20408 | | | | | | | | | |
| REFLEXION | 20419 | | | | | | | | | |
| RICH SOUND RESEARCH(RSR) | 20405 | | | | | | | | | |
| SAMSUNG | 20304 | | | | | | | | | |
| SANYO | 20429 | | | | | | | | | |

Brand List SOUNDBAR

| Soundbar Maker/ Brand | Code Number | | | | | | | | | | |
|--------------------------|-------------|--|--|--|--|--|--|--|--|--|--|
| SENTRY | 20407 | | | | | | | | | | |
| SONOS | 20449 | | | | | | | | | | |
| SONY | 20446 | | | | | | | | | | |
| TAOTRONICS | 20416 | | | | | | | | | | |
| TOSHIBA | 20422 | | | | | | | | | | |
| VELODYNE | 20404 | | | | | | | | | | |
| VIZIO | 20451 | | | | | | | | | | |
| VOGELS | 20411 | | | | | | | | | | |
| YAMAHA | 20427 | | | | | | | | | | |
| ZVOX | 20401 | | | | | | | | | | |

KAON