

CHILLBUSTER 2

Decorative Vented/Unvented Gas Log Set
General Assembly, Installation, and Operation Instructions



Rasmussen[®]
THE GAS LOG COMPANY

12028 E. PHILADELPHIA ST.
WHITTIER, CA CALIFORNIA 90601 U.S.A.
www.rasmussen.biz

Last Printed 2/28/2012 8:28 AM

ATTENTION! READ INSTRUCTIONS CAREFULLY BEFORE ASSEMBLY OR USE

“Chillbuster Evening Embers” Models: C2A (30,000 Btu), C2B (40,000 Btu) ; 18, 24 or 30, -ME, -M, -SE, -S, -RE or EI Natural Gas (N) or Propane Burners (P) with KW, K, KW18, 24 or 30 Log Sets.

WARNING: If the information in this manual is not followed exactly, a fire or explosion may result causing property damage, personal injury or loss of life.

This is an unvented gas-fired heater. It uses air (oxygen) from the room in which it is installed. Provisions for adequate combustion and ventilating air must be provided. Refer to pages 5 and 6.

— Do not store or use gasoline or other flammable vapors and liquids in the vicinity of this or any other appliance.

INSTALLER: Leave this manual with the appliance.
CONSUMER: Retain this manual for future reference.

— **WHAT TO DO IF YOU SMELL GAS**

- Do not try to light any appliance.
- Do not touch any electrical switch; do not use any phone in your building.
- Immediately call your gas supplier from a neighbor's phone. Follow the gas supplier's instructions.
- If you cannot reach your gas supplier, call the fire department.

This appliance may be installed in an aftermarket, permanently located, manufactured (mobile) home, where not prohibited by local codes.

— Installation and service must be performed by a qualified installer, service agency or the gas supplier.

This appliance is only for use with type of gas indicated on the rating plate. This appliance is not convertible for use with other gases. Field conversion is not permitted. Gas type conversion may only be accomplished at the factory. Please contact Rasmussen for details.

Installation must conform with local codes or, in the absence of local codes, with the National Fuel Gas Code, ANSI Z223.1/NFPA 54.

WARNING

This appliance is for installation only in a solid-fuel burning masonry or *UL 127* factory-built fireplace or in a listed ventless firebox enclosure. It has been design certified for these installations. Exception: **DO NOT** install this appliance in a factory-built fireplace that includes instructions stating it has not been tested or should not be used with unvented gas logs.

In the Commonwealth of Massachusetts:

- Installation must be performed by a licensed plumber or gas fitter.
- The chimney flue damper, when used with gas logs, will be welded open or completely removed.
- A CO detector shall be installed in the room where the appliance is installed.

IMPORTANT:

An unvented room heater having an input rating of more than 10,000 Btu per hour shall not be installed in a bedroom or bathroom. Do not install this appliance in a bedroom or bathroom.

The Minimum Fireplace Size (in inches) in which this Chillbuster set is to be installed must be as follows:

| Set Size | Model Number | BTU/hour | Front Width | Rear Width | Depth | Height |
|----------|------------------------------|---------------|-------------|------------|-------|--------|
| 18 | C2A-(ME,M,SE,S,RE,EI)-(N,P) | 30,000 | 24" | 18" | 14" | 17" |
| 24 | C2A/B-(ME,M,SE,S,RE,EI)-N,P) | 30,000/40,000 | 30" | 24" | 14" | 17" |
| 30 | C2B-(ME,M,SE,RE,EI)-(N,P) | 40,000 | 36" | 30" | 14" | 17" |

CHILLBUSTER™ Contemporary Gas Heaters are certified to the following standards:

- UNVENTED ROOM HEATER ANSI - Z21.11.2-2011
- VENTED DECORATIVE APPLIANCE - ANSI Z21.60b-2009

ALL APPLICATIONS (INSTALLATION)

ALL APPLICATIONS-IMPORTANT NOTICE

- Children and adults should be alerted to the hazard of high surface temperature and should stay away to avoid burns or clothing ignition.
- Young children should be carefully supervised when they are in the same room with the appliance.
- Do not place clothing or any other flammable material on or near the appliance.
- Any safety screen or guard removed for servicing an appliance must be replaced prior to operating the heater.
- **WARNING:** During manufacturing, fabricating, and shipping, various components of CHILLBUSTER are treated with certain oils or films. These are not harmful but may produce annoying smoke and smells as they are burned off during the initial operation of the appliance, possibly causing headaches or eye or lung irritation. This is a normal and temporary occurrence. The initial break-in operation should last 2-3 hours with the burner at the highest setting. Provide maximum ventilation by opening windows, doors, and the chimney flue to allow odors to dissipate. The only odor remaining after this initial break-in will be the normal odors associated with the combustion of Natural or Propane gas.
- This appliance is equipped with an ODS (OXYGEN DEPLETION SENSOR) pilot light safety system designed to shut itself off if not enough fresh air is available. Additional ventilation may be obtained by opening a window or a door to another room.
- Although your CHILLBUSTER is very realistic in appearance, it is not a real wood burning fireplace. Matches, paper, garbage, or any other material must not be thrown on top of the logs or into the flames.
- Avoid contact with the logs, grate, or any other part which may be hot.
- Always ensure that the fireplace screen is closed when the appliance is operating..

ALL APPLICATIONS-IMPORTANT INSTALLATION INFORMATION

WARNING: Design certified for installation only in a solid-fuel burning masonry or UL 127 factory-built fireplace or in a listed ventless firebox enclosure. It has been design certified for these installations. DO NOT install this appliance in a factory-built fireplace that includes instructions stating it has not been tested or should not be used with unvented gas logs.

"WARNING: Any change to this heater or its controls can be dangerous."

Installation and repair should be done by a qualified service person. The appliance should be inspected before use and at least annually by a professional service person. More frequent cleaning may be required due to excessive lint from carpeting, bedding material, etc. It is imperative that control compartments, burners and circulating air passageways of the appliance be kept clean.

State or local codes may only allow operation of this appliance in a vented configuration. Check your state or local codes. If not permitted, you may install and operate CHILLBUSTER as a vented appliance. (See "VENTED OPERATION" page 3).

This appliance is for supplemental heating only. It should not be used as the primary heat source for a dwelling.

Due to high temperatures, the appliance should be located out of traffic and away from furniture and draperies.

"WARNING: Failure to keep the primary air opening(s) of the burner(s) clean may result in sooting or property damage."

1. This appliance may be installed in an after market, permanently located, manufactured (mobile) home, where not prohibited by local codes.
2. This appliance is for use with the type of gas indicated on the rating plate. This appliance is not field convertible for use with other gases. **Gas type conversion may only be accomplished at the factory.**
3. Do not use this appliance if any part has been under water. Immediately call a qualified service technician to inspect the appliance and to replace any part of the control system and any gas control which has been under water.
4. If local valve is not already installed, install a gas valve on the supply line in or just outside the fireplace.
5. A fireplace screen must be in place when the CHILLBUSTER is in operation and, unless other provisions for combustion air are provided, the screen shall have opening(s) for introduction of combustion air. Glass doors are not certified with the CHILLBUSTER. However, if used, **Glass Doors must be wide open when the burner is on** to allow air for safe combustion, cooling of components and venting. Adequate clearances must be provided around fireplace opening for adequate combustion and proper operation. (see page 5)

ALL APPLICATIONS (INSTALLATION)

Fireplace/Firebox Sizing (VENTED and VENT-FREE):

1. The minimum size (in inches) of the fireplace in which this CHILLBUSTER is to be installed must be as follows:

| SET SIZE | MODEL NUMBER | FRONT WIDTH | HEIGHT | DEPTH |
|----------|--|-------------|--------|-------|
| 18 | (K,W,KW)(18)-C2A-(M,S,R)-(N,P) 30,000 BTU/HR | 24 | 17 | 14 |
| 24 | (K,W,KW)(24)-C2A-(M,S,R)-(N,P) 30,000 BTU/HR | 30 | 17 | 14 |
| 24 | (K,W,KW)(24)-C2B-(M,S,R)-(N,P) 40,000 BTU/HR | 30 | 17 | 14 |
| 30 | (K,W,KW)(30)-C2B-(M,S,R)-(N,P) 40,000 BTU/HR | 36 | 17 | 14 |

Gas Supply and Pressure (VENTED and VENT-FREE):

- Natural Gas:** The minimum inlet gas supply pressure for the purpose of input adjustment shall be 5 inches of water column. The maximum inlet gas supply pressure shall be 7 inches of water column.
- Propane Gas:** The minimum inlet gas supply pressure for the purpose of input adjustment shall be 11 inches of water column. The maximum inlet gas supply pressure shall be 14 inches of water column.

The Propane source must be regulated. Never connect CHILLBUSTER directly to an unregulated Propane tank.

Preparation Of Fireplace (VENTED and VENT-FREE):

- Ensure firebox and chimney damper/flue are thoroughly cleaned (if previously used for either gas or wood burning.)

WARNING: Before installing in a solid fuel burning fireplace, the chimney flue and firebox must be cleaned of soot, creosote, ashes and loose paint by a qualified chimney cleaner.

- The area around the CHILLBUSTER must be clear and free from combustible materials, gasoline and any other flammable vapors and liquids. Provide adequate clearances for servicing and proper operation.
- Any outside air ducts and/or ash dumps in the fireplace shall be permanently closed at time of installation.

WARNING: Do not use a blower insert, heat exchanger insert or other accessory not approved for use with this heater.

WARNING: Do not allow fans to blow directly into the fireplace. Avoid any drafts that alter burner flame patterns.

Pressure Testing (VENTED and VENT-FREE):

- Use Propane Gas resistant compound on all pipe fittings (not on connections with flared fitting).
- The CHILLBUSTER and its individual shutoff valve must be disconnected from the gas supply piping system during any pressure testing of that system at test pressures in excess of 1/2 psig (3.5 kPa). The CHILLBUSTER must be isolated from the gas supply piping system by closing its individual manual shutoff valve during any pressure testing of the gas supply piping system at test pressures equal to or less than 1/2 psig (3.5 kPa).
- Test new piping for leaks using soap solution. **Do not use open flame to flame test.**

VENTED INSTALLATION (Additional Requirements)

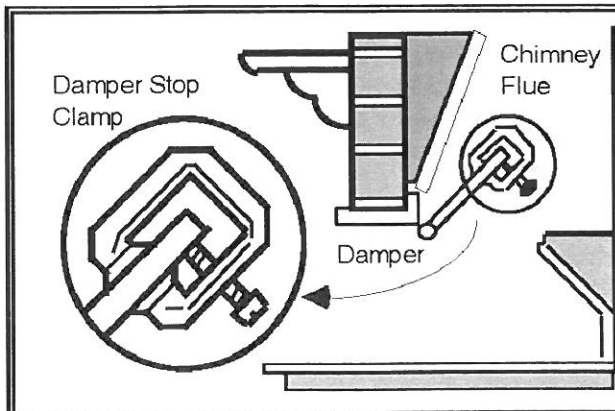

General Information (VENTED):

- The minimum permanent free opening of the fireplace chimney or chimney damper must be at least 29 sq. inches based upon a minimum chimney height of at least 10 feet.
- Solid fuels shall not be burned in a masonry or UL 127 factory built fireplace where a CHILLBUSTER is installed.

Damper Clamp (VENTED):

- The chimney damper must be fixed in a manner to maintain permanent free opening as (outlined in item above) at all times. To accomplish this, install the damper clamp (provided) on the edge of the damper blade to prevent its closing, or drill holes in the damper.

VENT-FREE APPLICATIONS (Additional Requirements)

1. Do not use this CHILLBUSTER as a Vent Free Heater in sleeping quarters, bathrooms or recreational vehicles.
2. When operated as a **VENT FREE** heater, the minimum clearances from the fireplace opening to combustible materials must be maintained as outlined in section "**CLEARANCES TO COMBUSTIBLES**" (page 6).
3. The installation and the provision for combustion and ventilation air must conform with the National Fuel Gas Code ANSI Z223.1 latest edition.

Provisions For Adequate Combustion And Ventilation Air (VENT-FREE):

This heater shall not be installed in a "confined" space or unusually tight construction unless provisions are provided for adequate combustion and ventilation air.

Confined Or Unconfined Space Determination (VENT-FREE)

The National Fuel Gas Code defines a confined space as a space whose volume is less than 50 cubic feet per 1,000 Btu per hour (4.8m³ per kW) of the aggregate input rating of all appliances installed in that space and an unconfined space as a space whose volume is not less than 50 cubic feet per 1,000 Btu per hour (4.8m³ per kW) of the aggregate input rating of all appliances installed in that space. Rooms communicating directly with the space in which the appliances are installed, through openings not furnished with doors, are considered a part of the unconfined space.

Calculations To Determine Confined Or Unconfined Space (VENT-FREE):

| | |
|---|---|
| 1. Determine number of rooms (including adjoining rooms with doorless passageways or ventilation grates.) | <i>Example:</i> Living room/dining room + Kitchen |
| 2. Determine the Total Volume of the Space (width x length x height). | Living room/dining room 14' x 20' x 8' = 2240 cu ft Kitchen 8' x 12' x 8' = 768 cu ft <hr/> Total Volume of Space 3008 cu ft |
| 3. Divide the total space volume by 50 cuft to determine the Maximum Supportable Btu/Hr. | $3008 \text{ cu ft} \div 50 = 60.160 \times 1000 = \mathbf{60,160}$ Maximum Supportable Btu/Hr = 60,160 Btu/Hr. |
| 4. Add the rated (Btu/hr) of all fuel burning appliances in the "space" to determine Actual Btu/Hr Used. | Vent free gas log heater 40,000 Btu/Hr Gas water heater 32,000 Btu/Hr <hr/> Actual Btu/Hr Used 72,000 Btu/Hr Note: Do not include direct vent gas appliances. |
| 5. Compare Maximum Supportable Btu/Hr against Actual Btu/hr Used. | <hr/> Maximum Supportable Btu/Hr=60,160 Btu/Hr Actual Btu/Hr Used= 72,000 Btu/Hr <hr/> Excess Btu/Hr= 11,840 Btu/Hr |

- If **Actual Btu/Hr Used** is greater than **Max Supportable Btu/Hr** then space is **CONFINED**.
- If the **Actual Btu/Hr Used** is less than **Maximum Supportable Btu/Hr** then space is **UNCONFINED**. In the example, because the **Actual Btu/Hr Used** exceeds the **Maximum Supportable Btu/hr** the space would be considered a **Confined Space** requiring you to either increase the **Maximum Supportable Btu/Hr**, decrease the **Actual Btu/Hr Used** or operate as a **Vented Appliance** (see page 3).

Adequate Combustion And Ventilation Air Options (VENT-FREE):

- Increase the **Maximum Supportable Btu/Hr** by adding to the number of rooms which comprise the "Space". To do this you must either completely remove the door to an adjoining room or provide two permanent ventilation grills; one within 12" of the ceiling and another within 12" of the floor.
- Increase the **Maximum Supportable Btu/Hr** by providing extra fresh air using ventilation grills and ducts to the outdoors. You must provide two permanent openings, one within 12" of the ceiling and another within 12" of the floor. Connect these directly to the outdoors or spaces open to the outdoors, e.g., attics or crawl spaces.
- Follow the *National Fuel Gas Code NFPA 54/ANSI Z223.1, Section 5.3, Air for Combustion and Ventilation* for required size of ventilation grills or ducts.
- Lower the **Actual Btu/Hr Used** by relocating other gas burning appliances outside the "space" or installing a lower Btu/Hr heater. In the example, the maximum Btu/Hr of the heater could be no more than 28,160 Btu/Hr.

For our example, we have chosen to add to our **Total Volume of the Space** by removing the door to an adjoining study and increasing our **Maximum Supportable Btu/Hr** by the volume of the additional room. The new "space" calculations, including the additional adjoining room are:

| | |
|-----------------------------------|-------------------|
| Living room/dining room & Kitchen | 3008 cu ft |
| Study (9' x 10' x 8') | 720 cu ft |
| Total volume of space | 3728 cu ft |

The new **Maximum Supportable Btu/Hr** = $(3728 \text{ cu ft} \div 50 \text{ cu ft}) \times 1000 = \mathbf{74,560 \text{ Btu/Hr}}$

74,560 Btu/Hr = Maximum Supportable Btu/Hr
- 72,000 Btu/Hr = Actual Btu/Hr Used
2,560 Btu/Hr = Remaining Supportable Btu/Hr

Because the **Actual Btu/Hr** used is now less than the **Maximum Supportable Btu/Hr**, the space is considered an **Unconfined Space**. No additional fresh combustion and ventilation air would be required.

VENT-FREE APPLICATIONS (Additional Requirements)

COMBUSTION AIR CALCULATIONS WORKSHEET

| 1. | Room | Width | Length | Height | W x L x H=Vol. (ft ³) | | | | |
|-----|--|---------------|------------|---------------|-----------------------------------|---------------|------------|---------------|---|
| 1a. | | | | | | | | | |
| 1b. | | | | | | | | | |
| 1c. | | | | | | | | | |
| 1d. | | | | | | | | | |
| 2. | Total Volume (ft³) sum of Volume (ft ³) of all rooms (sum lines 1 a. thru 1d.) | | | | 2. | | | | |
| 3. | Max Supportable Btu/Hr =Total Volume (ft ³) ÷ 50 x 1000 (line 2 ÷ 50 x1000) | | | | 3. | | | | |
| 4. | 4a. | Btu/hr | 4b. | Btu/hr | 4c. | Btu/hr | 4d. | Btu/hr | |
| | Actual Btu/hr used = Sum Btu/hr of all fuel burning appliances inside the space identified as rooms 1a. thru 1.b (sum line 4a thru 4d.) | | | | | | | | |
| 5. | (Maximum Supportable Btu/Hr) minus (Actual Btu/hr Used) (Line 3 - line 4) | | | | | | | 5. | * |

- * If Line 5 is greater than zero, the **Actual Btu/Hr Used** is **less** than the **Maximum Supportable Btu/Hr** and the space is considered **UNCONFINED**. No additional fresh combustion and ventilation is required.
- * If Line 5 is zero or less, the **Actual Btu/Hr Used** is **greater** than **Maximum Supportable Btu/Hr** and the space is **CONFINED**. You must either **increase** the **Maximum Supportable Btu/Hr**, **decrease** the **Actual Btu/Hr Used** or **operate as a Vented Appliance** (see page 3).

WARNING: If the area in which the heater may be operated is smaller than that defined as an unconfined space or if the building is of unusually tight construction, provide adequate combustion and ventilation air by one of the methods described in the National Fuel Gas Code, ANSI Z223.1, 1992, Section 5.3 or applicable local codes.

Unusually tight construction is construction where:

- a) Walls and ceilings exposed to the outside atmosphere have a continuous water vapor retarder with a rating of 1 perm or less with openings gasketed or sealed, and
- b) Weather stripping has been added on openable windows and doors, and
- c) Caulking or sealants are applied to areas such as joints around window and door frames, between sole plates and floors, between wall panels, at penetrations for plumbing, electrical, and gas lines, and at other openings.

WARNING: CARBON MONOXIDE POISONING MAY LEAD TO DEATH

When used without fresh air, gas log sets may give off carbon monoxide, an odorless, colorless, poisonous gas. Some people, pregnant women, persons with heart or lung disease, anemia, or under the influence of alcohol and persons at high altitudes are more affected by carbon monoxide than others. Early signs of carbon monoxide poisoning resemble the flu: Headache, dizziness, and/or nausea. If you have these signs, the gas log may not be installed or working properly, or the chimney flue may be blocked. **GET FRESH AIR AT ONCE!** Have gas log set and chimney flue serviced before using again.

OPEN A WINDOW AN INCH OR TWO FOR ADEQUATE COMBUSTION AND VENTILATION AIR WHEN USING YOUR VENT FREE GAS LOG ROOM HEATER

Minimum Clearances To Combustibles (VENT-FREE):

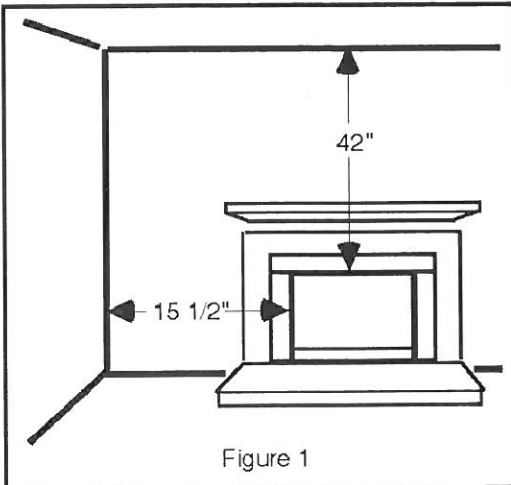

Side wall: 15 1/2" from side of fireplace opening. Figure 1

Ceiling: 42" from top of fireplace opening. Figure 1

Mantel: See Charts and Diagrams shown at Figures 2 and 3

NOTE: "Clearances to Combustible Construction" are those distances required to ensure that a fireplace mantel or facing will not catch fire. In most cases they should also be adequate to prevent any discoloration or warping due to heat. However, each and every Gas Log Installation (CHILLBUSTER included) presents a different and completely unique set of circumstances involving many variables beyond the control of the Gas Log Manufacturer. These include paint or finish composition, previous exposure to heat, methods and quality of construction, air flow patterns, glass doors, fans or blowers, etc.. Because of these variables, we cannot guarantee that heat warping or discoloration will never occur. The potential for heat warping or discoloration may exist whether you are burning a CHILLBUSTER, some other manufacturer's Gas Log or even wood.

VENT-FREE APPLICATIONS (Additional Requirements)

Fireplace Hoods (VENT-FREE)

A fireplace hood deflects heat away from the fireplace face and mantel, reducing the potential for heat related warping or discoloration. **The use of a fireplace hood is highly recommended.** Fireplace Hoods are offered by many leading fireplace manufacturers.

Mantel Clearance Without Hood:

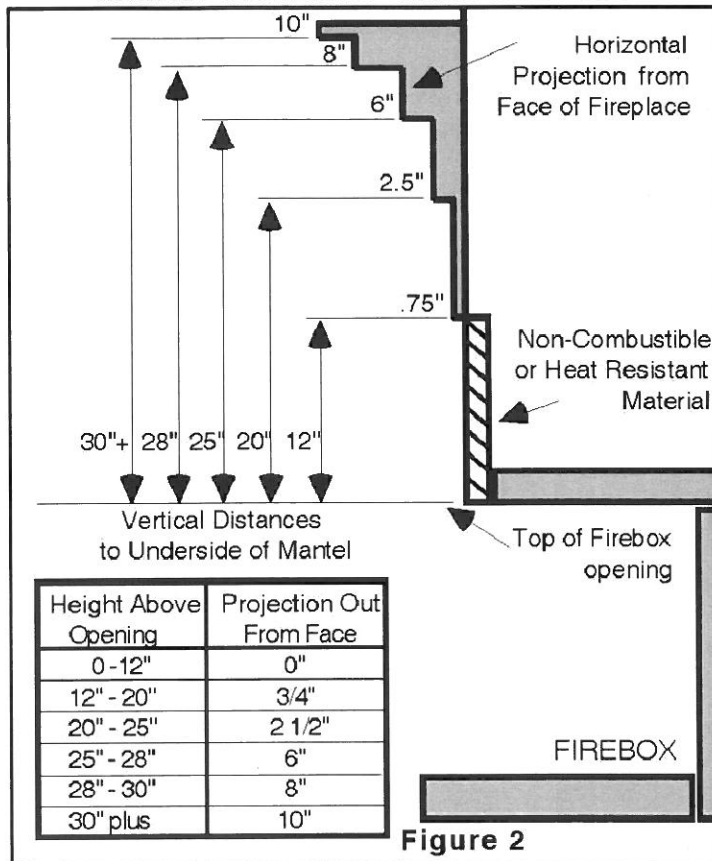

Mantel Clearance With Hood*:

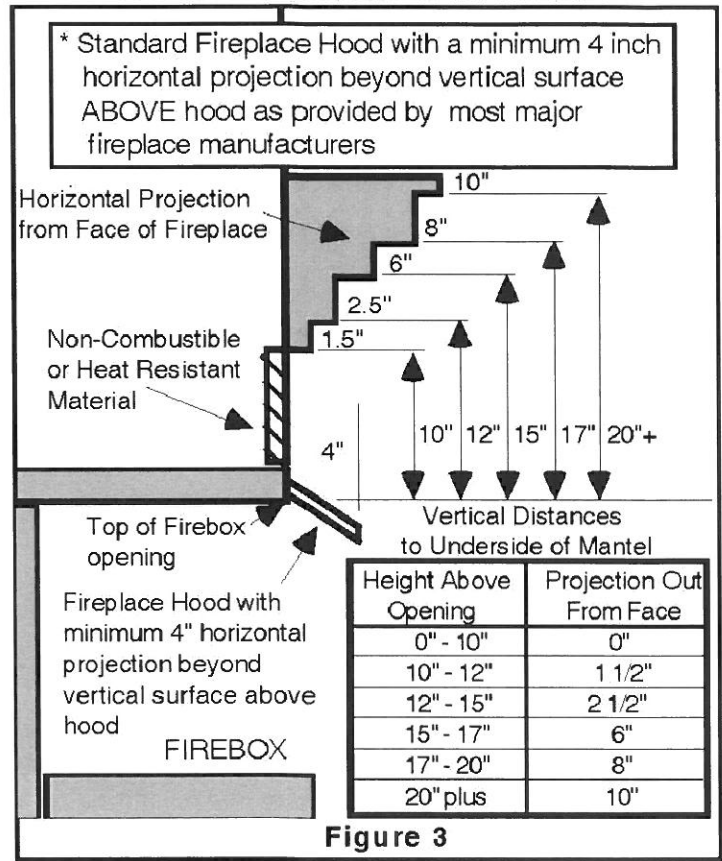

IF YOU CANNOT MEET THESE MINIMUM CLEARANCES YOU MUST OPERATE HEATER WITH CHIMNEY FLUE DAMPER OPEN (Operate as a VENTED Heater - See Page Three).

ALL APPLICATIONS (VENTED and VENT FREE OPERATION)

ASSEMBLY AND INSTALLATION

Attaching Ember Tray:

1. Attach ember tray to the front two legs of the grate with the nuts and bolts provided on grate. **See Figure 6.**

Installing Chillbuster Burner Unit Into Fireplace:

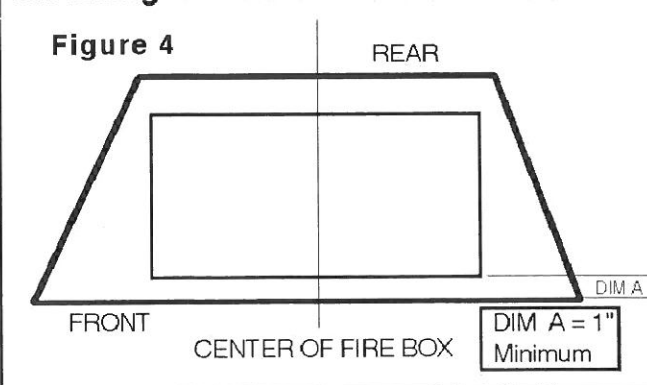

1. Place grate/control assembly inside firebox **or approved enclosure**. Center grate left to right with the front portion of the grate assembly no less than 1" from the opening of the firebox. **See figure 4.**
2. Connect CHILLBUSTER to gas supply line with supplied semi rigid aluminum connector, or other flexible connector. Use a pipe joint compound which is resistant to the action of Propane gases on all pipe threaded joints except on the flared connector fittings.
3. Turn on the gas valve at the supply line in the fireplace. Check connections for gas leaks by using a soapy solution. **Do not use open flame.**

Volcanic Ash Placement:

Sprinkle the VOLCANIC ASH around the firebox floor.

NEVER PLACE VOLCANIC ASH ON TOP OF ANY BURNER.

ALL APPLICATIONS (VENTED and VENT FREE OPERATION)

Ember Material Preparation

1. Prepare the ember material by pulling apart into loose pieces (not tight clumps) the size of a dime. **See Figure 5.**

2. Place the loose pieces in the ember tray, building a ramp which completely covers the **Front Burner**. The loose clumps should be no more than one to two pieces of ember material in depth. The looser the pieces, the better the glowing

And Placement:

Figure 5



ember effect! **See Figure 6.**

3. Excess embers may be placed on each side of the **Front Burner** to hide the burner/grate attachment points.

Ember material is only for use with the Front Burner.

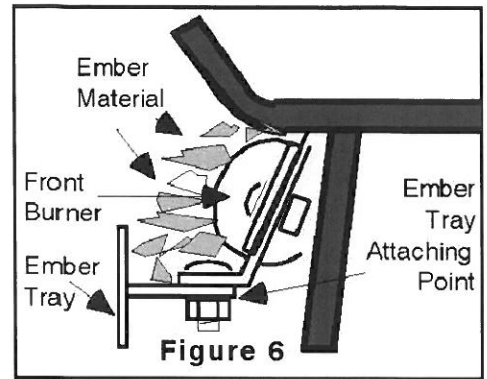

Figure 6

WARNING: Excessive amounts of Ember Material or Ember Material which is too tightly packed can result in decreased combustion performance and elevated levels of carbon monoxide. Looser pieces of Ember Material produce more efficient combustion performance and enhance the overall glowing ember effect.

Volcanic Ash Placement: Sprinkle VOLCANIC ASH on the firebox floor. Volcanic ash can be ramped to within 1/4" of the top of the ember tray. **DO NOT PLACE VOLCANIC ASH ON TOP OF THE BURNER.**

Log Placement:

1. Place the largest log (FRONT LOG) on the front of the grate and the second largest log (REAR LOG) on the rear of the grate behind the LOCATOR PINS. **Fig. 7 and 8.**
2. Place both Right and Left LARGE TOP LOGs across the FRONT and REAR logs with the LOCATOR PINS

3. inserted into the drilled holes located on the bottom of both LARGE TOP LOGs. **Figures 7 and 8.**
3. Place R and L SMALL TOP LOGs across the FRONT LOG and LARGE TOP LOGs with the LOCATOR PINS inserted into the drilled holes. **Figures 7 and 8.**

To ensure optimum performance, logs must be placed on burner as depicted. Do not Allow Small Top Logs to Cross Flame Path.

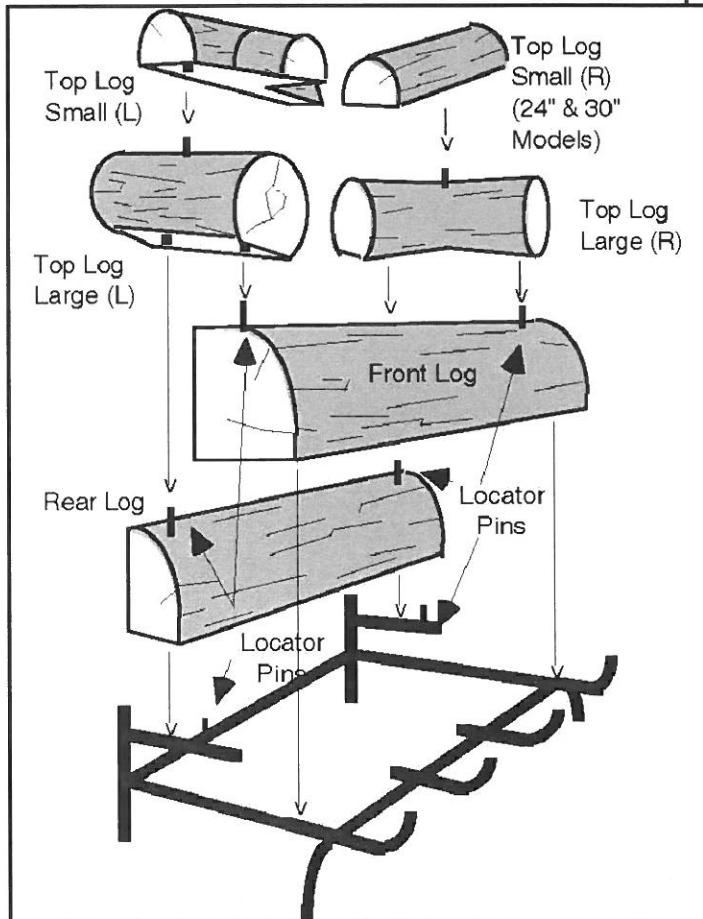

Figure 7

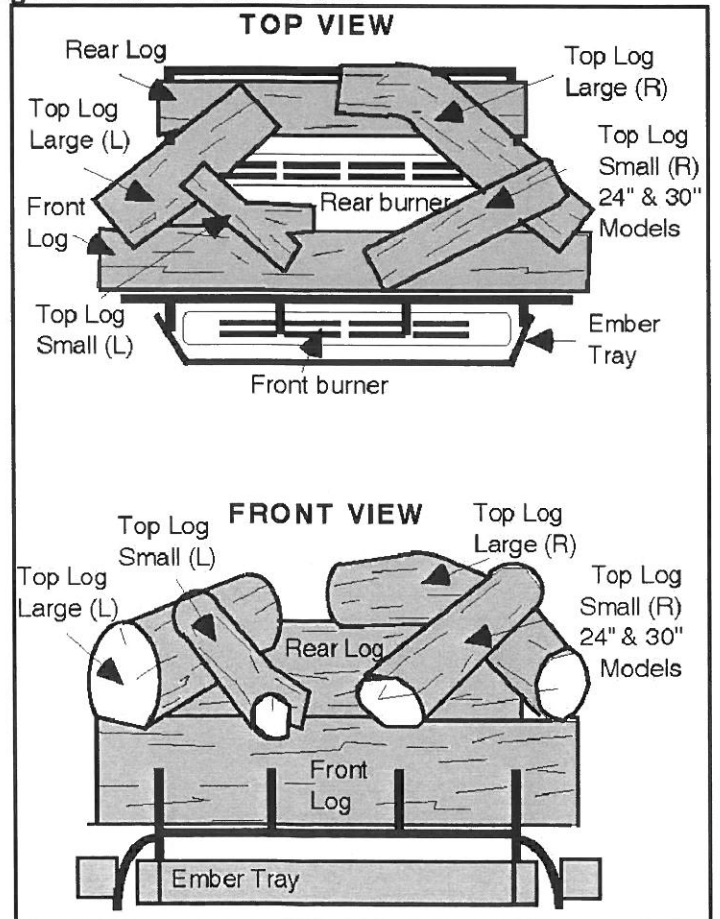

Figure 8

Note: 18" Log Sets consist of 5 logs only. Top Log Small(R) on 24" and 30" sets only.

WARNING: Failure to position parts in accordance with these diagrams or failure to use only parts specifically approved with this heater may result in property damage or personal injury.

ALL APPLICATIONS (VENTED and VENT FREE OPERATION)

C2A-M and C2B-M (MANUAL CONTROL) OPERATION

Pilot Lighting, Operation, and Shutting Down:

Ignitor Button

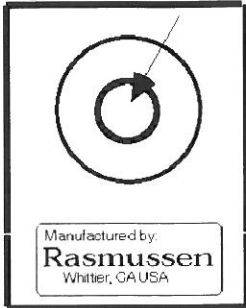

Figure 9

1. Slightly push knob and turn to **"SEASON OFF"**. **Figure 10**
2. Before lighting, wait at least five minutes (10 minutes for LP gas) to allow gas which may have accumulated around burner to escape.
3. Slightly push knob and turn to **"PILOT/OFF"**. **Figure 10**
4. Depress valve knob until air is bled and gas flows to pilot. Press Piezo IGNITOR Button (**Figure 9**) to light pilot. Continue to hold valve knob in until Pilot remains lit when knob is released.
5. Slowly turn knob to **"ON"**. The rear burner will light from the pilot. The front burner will light from the carry-over tube.
6. If appliance fails to light or if pilot goes out, repeat steps 1 through 5.
7. For complete shutdown, push knob in and turn to **"SEASON/OFF"**.

Valve Knob

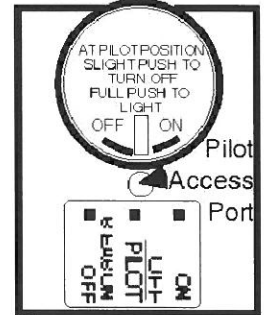

Figure 10

C2A/B-S or C2A/B-R (Switch or Remote Millivolt) LIGHTING

Control Pilot Lighting:

NOTE: The **Gas Cock Dial** has complete control of gas to pilot and burner. The **Gas Cock Dial** cannot be turned to "OFF" without first depressing dial in **"PILOT"** position and then rotating clockwise to **"OFF"**.

1. Depress and turn **Gas Cock Dial** to **"OFF"** position.
2. Put the **Control Selector Switch** into the **OFF** position. Any Accessory Controls must also be turned "OFF" (Remote Control) or to lowest temperature setting (Thermostat)
3. Wait at least 5 minutes to allow gas which may have accumulated around burner to escape.
4. Turn **Gas Cock Dial** to **"PILOT"** position.
5. Depress and hold **Gas Cock Dial** until air is bled and gas flows to pilot.
6. Press **Piezo Ignitor Button** to light pilot. Continue to holding in the **Gas Cock Dial** until the Pilot flame remains lit when knob is released (approximately 60 to 90 seconds). If Pilot does not remain lit, repeat steps 1 through 5 and allow more time after Pilot Lighting before releasing knob. (Figure 12)
7. Turn **Gas Cock Dial** to **"ON"**.

SELECTOR SWITCH

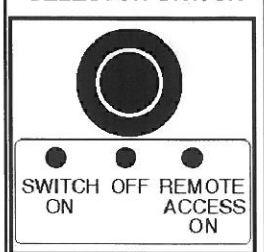
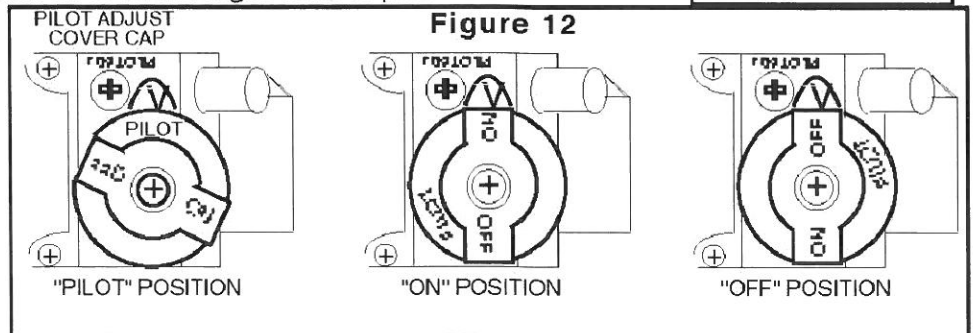

Figure 11



C2A/B-S (Switch Model) OPERATION

Switch Control Accessory Wiring:

NOTE: Wire length for Thermostat or Remote or controls should not exceed 20 feet.

Wiring from the Accessory Control (Remote, Thermostat or Switch) is connected to the two **outside terminals** of the **Control Selector Switch** as shown in **FIGURE 13**.

Thermostat wiring should be 20 AWG Type CL2.

Switch Control (Manual ON-OFF):

After successful pilot lighting, allow 60-90 seconds for Thermogenerator to heat up. To turn burner(s) on, place **Control Selector Switch (FIGURE 11)** in the **"ON"** position. To turn burner(s) off (pilot remains lit) place **Control Selector Switch** in the **"OFF"** position.

NOTE: Flame size at the burner(s) is adjustable at the **Gas Cock Dial (FIGURE 12)**.

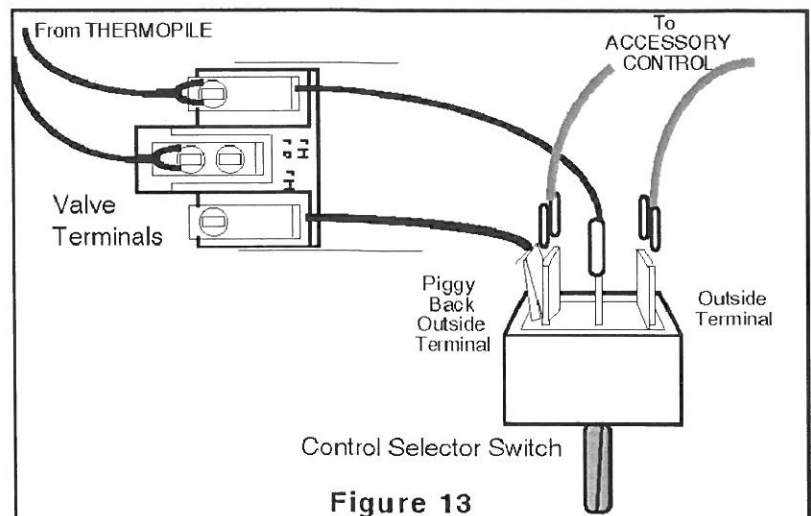

Figure 13

ALL APPLICATIONS (VENTED and VENT FREE OPERATION)

Switch Control Accessory Options:

ULTRA-SONIC WIRELESS REMOTE
 INFRARED WIRELESS REMOTE WITH THERMOSTAT
 WALL SWITCH
 WALL THERMOSTAT
 WALL TIMER (60 MINUTE TIMER)
 CRACKLER Sound Generator option for F10 AB or IRRC

Milivolt; "S" Models

(Model "F10-AB , SR-MVI, THR-MVI)
 (Model "IRRC")
 (Model "WS-1")
 (Model "TS-1")
 (Model "WT-1")
 (Model "CF5")

- Accessory **REMOTE LOG HOUSE (Model "RH")** is available for use as a heat resistant "log" in which the receiver portion of Wireless remote option **F10 AB** or **IRRC** may be located.
- Accessory **CRACKLER LOG HOUSE (Model "CH")** is available for use as a heat resistant "log" in which the **CRACKLER** Sound Generator option for both the **F10 AB** and **IRRC** wireless remotes may be located.

Switch Operation (Accessory): Place manual switch in the "**REMOTE ACCESS ON**" (**FIGURE 11**) position. Burner "**ON**" or "**OFF**" is now controlled by the position of the accessory control being used with the burner. Individual operating instructions for each Accessory Option are included with the individual accessory.

Complete Shutdown (Including Pilot): Place **Control Selector Switch** in "**OFF**". Turn "**OFF**" all **Accessory Switches**. Slightly push and turn **Gas Cock Dial** to "**OFF**".

C2A/B-R (Remote Model) Operation Of Ultrasonic Remote Control

Before you start: Both the transmitter and receiver require 9 volt batteries to operate in remote control.

The blue and black receiver wire leads are for the optional sound producing device (**CRACKLER**).

The receiver must be protected from overheating. Locate receiver well away from heat. Accessory **REMOTE LOG HOUSE (Model "RH")** is available for use as a heat resistant "log" in which the receiver portion of a Wireless remote option may be located.

Operation Tips: This is a sound operated remote (unlike TV remotes which are Infrared and operate instantly) and requires you to **aim and hold** the transmitter for **1 to 3 seconds** to operate.

Manual Operation: (Receiver switch position ON or OFF) does not require batteries.

Remote Operation: Requires good batteries. If you turn the gas log on using the remote control and then turn the set off by sliding the receiver switch from **REMOTE** to **OFF**, when you replace the switch to **REMOTE** it will remain in the last selected remote position (in this case **ON**) and turn the gas log on.

To shutdown overnight or for any prolonged period, slide receiver switch to "OFF".

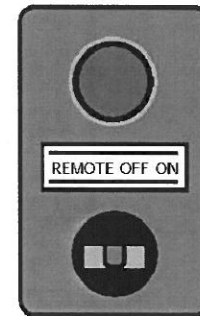

Manual: Switch from OFF to ON; ON to OFF

Remote: Switch to REMOTE. Aim, press button and hold transmitter at receiver.

When switching from REMOTE to OFF, first turn set off using the transmitter.

Pilot Operation and Flame Adjustment:

Op America (Manual Models):

1. **PILOT FLAME:** Pilot flame should be steady and soft blue surrounding 1/8 inch of the thermocouple tip as shown in **Figure 14**.
2. If adjustment is necessary, use a narrow long stem screw driver to turn pilot adjustment screw. **See Pilot Lighting instructions for each specific model's pilot adjustment screw location**
3. Turn clockwise for less pilot flame.
4. Turn counterclockwise for more pilot flame.

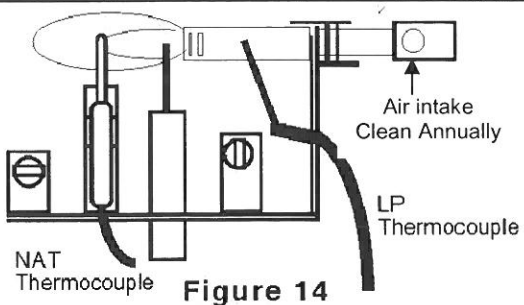

OP AMERICA Millivolt (Switch and Remote Models):

Note: The OP America Millivolt Pilot/ODS is equipped with a quick acting thermocouple allowing gas flow to the pilot after approximately 30-40 seconds. An additional 60 to 90 seconds time is required to adequately heat the thermogenerator and allow gas to the main burner(s).

1. **PILOT FLAME:** Pilot flame should be steady and soft blue extending approx. 1 inch beyond the pilot tube as shown in **Figure 15**.
2. If adjustment is necessary, use a narrow long stem screw driver to turn pilot adjustment screw.
3. Turn clockwise for less, counterclockwise for more pilot flame.

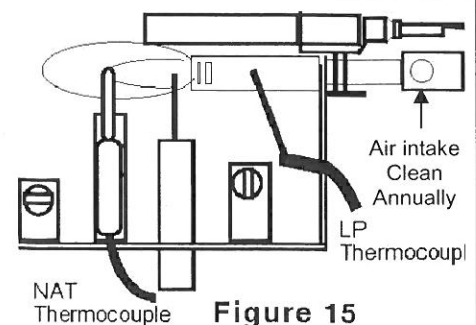

STEP FIVE: LIGHTING AND OPERATION (ALL MODELS)

1. Slightly push in the **“EASY” Safety Valve Knob**, located on the front right side of the CHILLBUSTER™ face plate (Figure 16 and Figure 14A), and turn clockwise to **“OFF”**.
2. Before lighting, wait at least five minutes to allow gas which may have accumulated around burner to escape, then slightly push in the **“EASY” Safety Valve Knob** and turn to **“PILOT/OFF”** (Figure 17).
3. Depress knob until air dissipates and gas flows to pilot. Press the **Piezo Ignitor Button** to light the pilot (Figure 15), and continue to hold knob in until pilot remains lighted after knob is released. The Pilot flame should be steady and soft blue surrounding 1/8 inch of the thermocouple tip and extending approximately 1 inch beyond the pilot tube as shown in Figure 19 below.
4. Slowly turn knob to **“ON”** (Figure 17) to light the burner.
5. If burner(s) fails to light or if pilot goes out, repeat steps 1 through 4.
6. Adjust the burner flame height by turning the **“EASY” Safety Valve Knob** clockwise to lower and counter-clockwise to raise up to full on.
7. For complete shutdown, push **“EASY” Safety Valve** in and turn to **OFF”**.

FIGURE 16

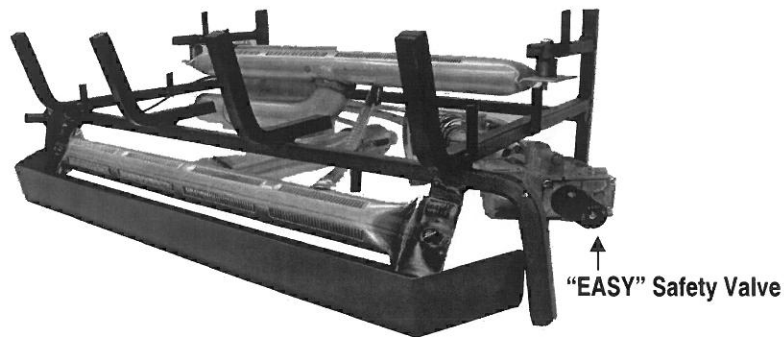
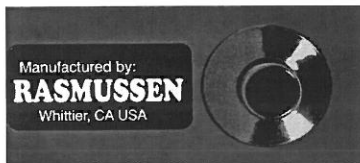

FIGURE 18



Piezo Ignitor Button:
Pilot Flame Ignition.

VALVE PLUG (“ME” MANUAL “EASY” CONTROL) SHOWN, ALSO LOCATION FOR;

- ON/OFF SOLENOID (“SE” REMOTE READY MODELS) OR
- DC MOTOR DRIVE (“RE” VARIABLE FLAME HEIGHT MODELS) BOTH SHOWN ON FOLLOWING PAGE.

FIGURE 17

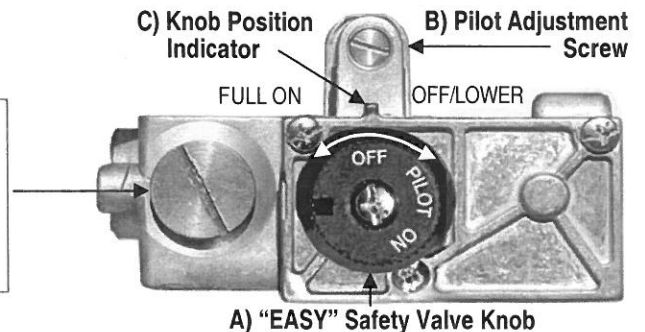
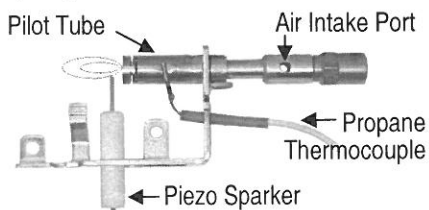

FIGURE 19

Models mfg’d from 6/99 thru 01/08

A) Propane Pilot Assembly (ODS-OP-P)



B) Natural Gas Pilot Assembly (ODS-OP-N)

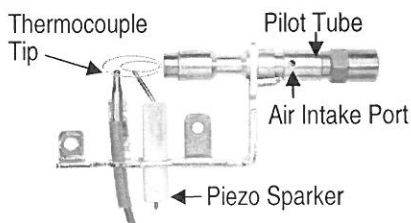

Models mfg’d from 01/08 to present

A) Propane Pilot Assembly (ODS-ROP-P)

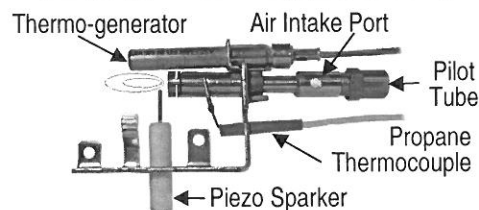

B) Natural Gas Pilot Assembly (ODS-ROP-N)

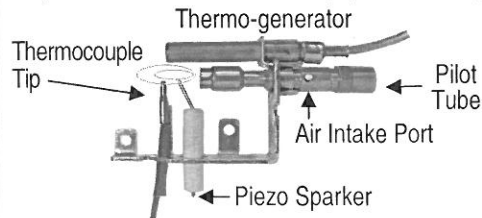

A) Propane Pilot Assembly (ODS-CN-P)

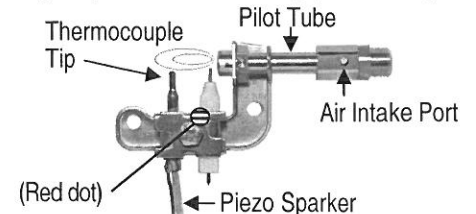

B) Natural Gas Pilot Assembly (ODS-CN-N)

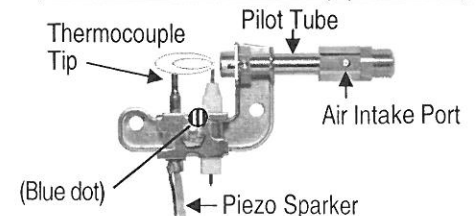

PILOT ADJUSTMENT (ALL MODELS)

PILOT FLAME ADJUSTMENT: If adjustment is necessary, use a narrow long stem screw driver to turn pilot adjustment screw. To adjust turn clockwise for less pilot flame, counterclockwise for more pilot flame.

IMPORTANT SERVICE TIP! Obstructed Pilot Air Intake Ports result in an improper gas/air mixture and a weak pilot flame. **Weak pilot flame is the NUMBER 1 SERVICE ISSUE REGARDING NUISANCE SHUT-OFF.** Using canned compressed air, a pipe cleaner or an artist's brush, clean out the opposing air intake ports located at the base of the pilot (where the gas supply line attaches to the pilot) (See pages 9, 10).

BURNER OPERATION (“RE” VARIABLE FLAME HEIGHT AND “SE” REMOTE READY MODELS)

1. Turn **Valve Knob** to “ON” position (Figure 20A)
2. Slide switch on the **Receiver** (Figure 21) to “REMOTE” position.

“RE” Models

3. Depress the “ON/HI” button on the **TRANSMITTER** (Figure 20B) until a click is heard. The burner will then light to “Full on”

NOTE: Reducing the burner flame can be achieved by pressing the “LO” button one beep at a time to the desired flame height. Pressing the “ON/HI” button one beep at a time will raise the burner flame). To verify the burner is completely off, press the “OFF” button once. **Variable flame height can only be achieved via the hand held remote.**

“SE” Models

3. Consult Operating Instructions for Accessory Control (below).
4. Adjust the burner flame height by turning the **Valve Knob** (Figure 22A) clockwise to lower and counter-clockwise to raise up to full on.

NOTE: During the heating season leave Valve Knob in “PILOT” position for convenience. Otherwise, turn to “OFF” position for any prolonged non-use.

FIGURE 20

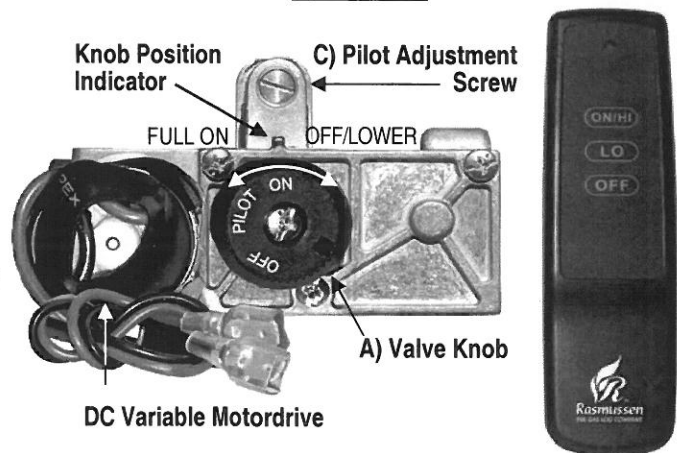
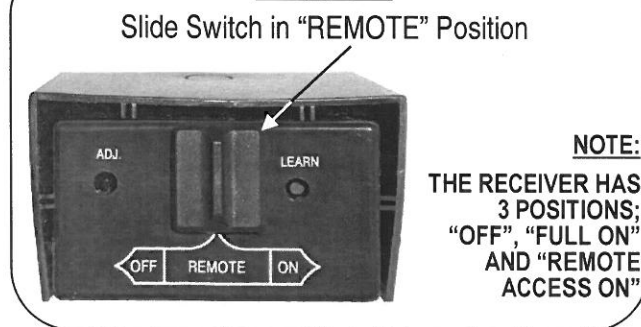

FIGURE 21



Accessory Controls

- | | | | | |
|--------------------------------|---|----------------------------------|------------------------------|---|
| Wireless On/Off Remote (SR-2R) | Wireless On/Off Remote with Thermostat (THR-2R) | Wireless Wall Thermostat (TS-2R) | Wireless Wall Switch (WS-2R) | Wireless Wall Timer (30/60/120 Minutes) (WT-2R) |
|--------------------------------|---|----------------------------------|------------------------------|---|

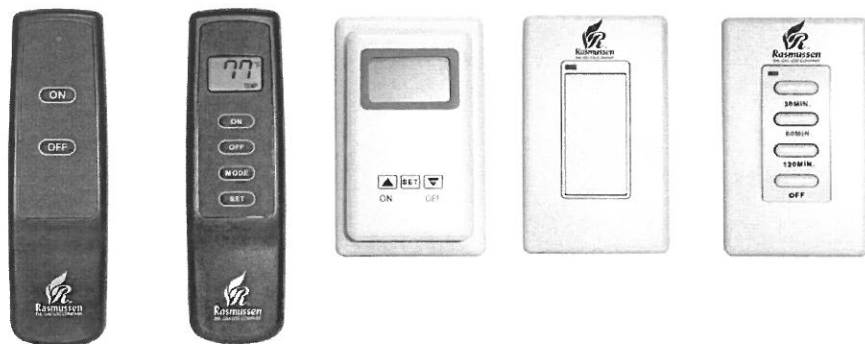
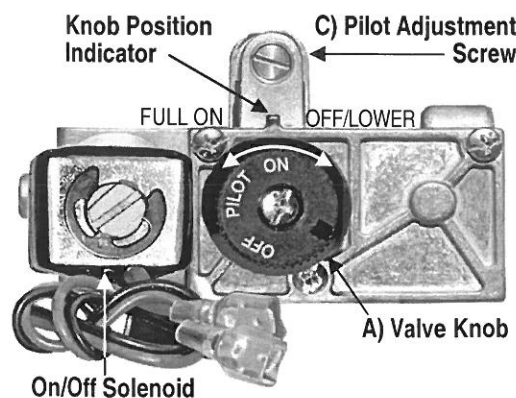

FIGURE 22



NOTE: The “EASY” Safety Valve has complete control of gas to the pilot and burners. It cannot be turned to “OFF” without first depressing knob to the “PILOT” position and then rotating clockwise to “OFF”. During the heating season leave valve knob in “PILOT” position for convenience. Otherwise, turn to “OFF” position for any prolonged non-use.

VENTED MODELS IMPORTANT!

CHIMNEY DAMPER MUST BE WIDE OPEN! THE FLUE MUST VENT ALL PRODUCTS OF COMBUSTION. DAMPER AND GLASS DOORS MUST BE FULLY OPEN BEFORE LIGHTING OR BURNING FOR PROPER VENTILATION AND TO PREVENT HEAT DAMAGE TO VALVE.

NOTE: The **Valve Knob** has complete control of gas to pilot and burner. The **Valve Knob** cannot be turned to “OFF” without first depressing knob in “PILOT” position and then rotating clockwise to “OFF”.

STEP ONE: Pilot Lighting (Remote Valve):

1. Depress and turn **Valve Knob** clockwise to “OFF” position. (Figure 22)
2. Set Accessory Control (Figure 24) to “OFF” (Switch or Remote Control) or to lowest temperature setting (Thermostat)
3. Wait at least 5 minutes to allow gas which may have accumulated around burner to escape.
4. Turn **Valve Knob** counter clockwise to “PILOT” position. (Figure 23)
5. Depress and hold **Valve Knob** until air is bled and gas flows to pilot.
6. Light pilot. Continue to hold in the **Valve Knob** until the pilot flame remains lit when knob is released (approximately 60 to 90 seconds). If Pilot does not remain lit, repeat steps 1 through 5 and allow more time after pilot lighting before releasing knob.
7. Turn **Valve Knob** to “ON”. (Figure 23) Black terminal wire removed to allow unobstructed view)

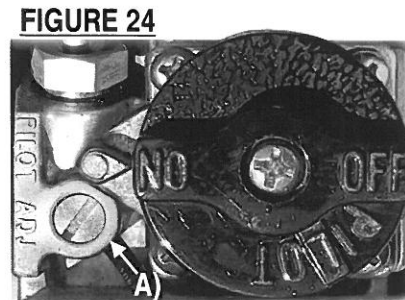
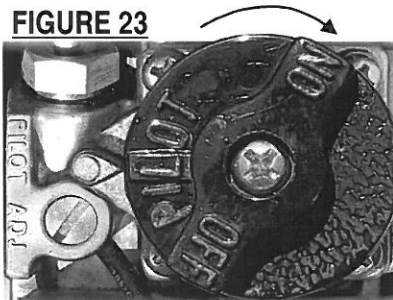
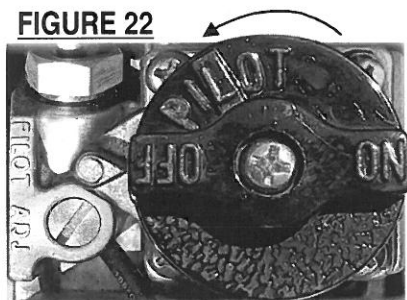

ADJUSTING BURNER FLAME HEIGHT USING THE REMOTE VALVE

Flame size at the burner is adjustable at the **Gas Valve Knob**. Turn the **Valve Knob** counter clockwise for more flame, clockwise for less flame.

For **Complete Shutdown (Including Pilot)**: Slightly push and turn **Valve Knob** to “OFF”.

Switch Accessory Wiring: Wiring from the Accessory Control (Remote, Thermostat or Switch) is connected to the **outside terminals** (Figure 26A and 26B) of the **Control Selector Switch** (Figure 25 and Figure 26C).

NOTE: Wire length for Thermostat, Remote or Controls should no exceed 20 feet. Thermostat wiring should be 20 AWG Type CL2

Switch Accessory Operation: Place the **Control Selector Switch** (Figure 24) in the “REMOTE ACCESS ON” position. Burner “ON” or “OFF” is now controlled by the position of the accessory control being used with the burner. Individual operating instructions for each Remote Accessory Option are included with the accessory.

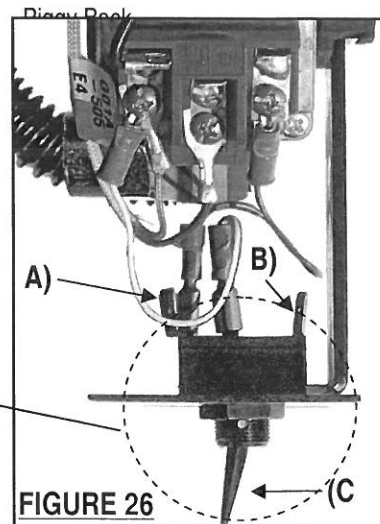
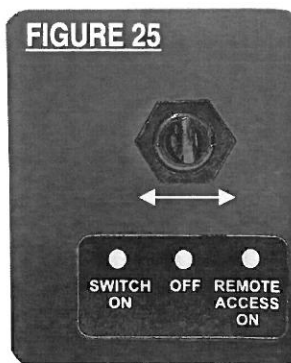

Connecting Accessory Controllers: Using the 20' accessory control wiring attached to the two **outside terminals** of the valve block (Figure 26A and 26B), connect the **Switch Control Accessory Option** (Remote, Thermostat, Switch, etc.) to valve.

ALL APPLICATIONS (VENTED and VENT FREE OPERATION)

NORMAL OPERATING CHARACTERISTICS

Each and every **CHILLBUSTER** that leaves the factory is quality checked to ensure compliance with our American Gas Association certification. This check includes an operational test to ensure both satisfactory combustion and proper operation.

Each installation site for any vent free heater presents its own unique combustion environment. Specific factors such as weather tightness of the home, size of the room in which the heater is installed, central heating, ceiling fans, drafts, altitude, the size of the firebox, paint or soot inside the firebox, etc., all have an influence on the proper operation of any vent free gas log set. A normally operating

CHILLBUSTER Gas Logs possesses the following characteristics:

- Clean burning combustion, which, after normal break in, will produce no soot or smoke.
- A full bodied, lively flame. The flame will be blue at the base and a combination of blue and yellow at the body and tips. **Figure 27.**
- After initial break-in produce no odor other than the normal odors associated with the combustion of Natural or Propane gas and/or the environment in which the heater is operated.
- Will produce water vapor (increase indoor humidity) which may be beneficial during the dry heating season.

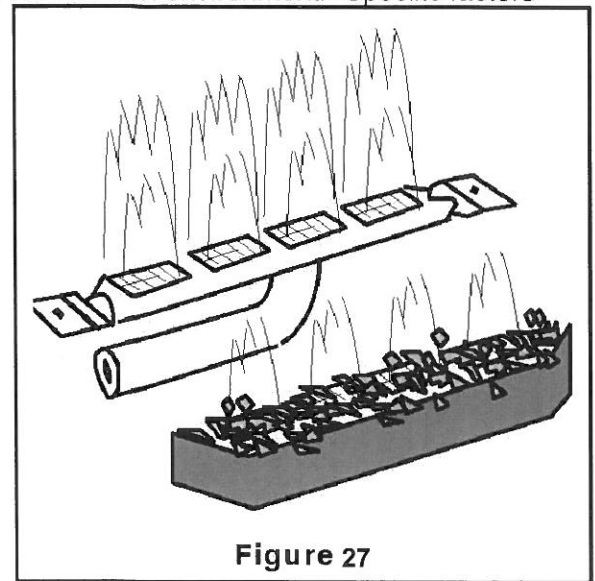

Figure 27

Customer Responsibilities And Annual Maintenance:

- Keep the area around the CHILLBUSTER free and clear from debris. From time to time, visually check pilot and burner flames for proper appearance (Figures 14,15 and 19). Normal flame color should be yellow body **surrounded by a hard blue haze.**
- The pilot, air shutters and burners must be free of lint and dirt for optimum performance. Air shutters which have been closed or are obstructed with debris will not allow sufficient combustion air into burner. Air shutters should be periodically cleaned of debris. Use compressed air or a soft bristle brush to clear pilot and burner(s) air intakes. **Air shutters should not be altered from factory settings. "WARNING: Failure to keep the primary air opening(s) of the burner(s) clean may result in sooting or property damage."**
- Obstructed Pilot Air Intake Ports result in an improper gas/air mixture and a weak pilot flame. **Weak pilot flame is the NUMBER 1 SERVICE ISSUE RE NUISANCE SHUT-OFF.** Using canned compressed air, pipe cleaner or an artist's brush, clean out the opposing Air Intake Ports located at base of Pilot (where gas supply line attaches to pilot). (Figures 14 and 15)
- Do not operate in a dirty firebox or in a previously used firebox which has not had all soot completely removed or it's chimney flue cleaned. Previously used fireboxes must have flue and stack professionally cleaned by a chimney sweep. Additionally, firebox walls and damper must also be thoroughly cleaned of all burn residue and soot using a damp cloth, sponge or brush.
- Do not operate this set with any logs other than the RASMUSSEN CHILLBUSTER Refractory Logs specifically designed and approved for use with this Burner System.
- Do not use with blower inserts or heat exchangers.
- If used, glass doors must be wide open when burner is on.
- Do not remove Rating Plate/Warning Tags. These tags serve you and any future user as an integral safety and identification component of the CHILLBUSTER gas log heater. Removing these tags voids the warranty.
- **WARNING: Do not allow fans to blow directly into fireplace. Avoid any drafts that alter burner flame patterns.** Do not place blower inside area of firebox. Ceiling fans may create drafts that alter burner flame patterns. Sooting and improper burning may occur. Sooting can settle on household surfaces outside the fireplace.
- During periods of heavy use, inspect frequently for evidence of sooting. If sooting is present, discontinue use until source of sooting is determined and corrected.
- Maintain log positioning as shown in Figures 7 and 8 at all times.

HOW TO ORDER PARTS

Parts can be ordered through the supplier from whom you purchased your log set.

When ordering parts, always specify (From information available on name plate attached to grate) the following:

1. Model number of the log set.
2. Serial number of the log set.
3. Type of gas (natural or propane Gas).
4. The name of the part and part number from parts list.

♦Save these instructions♦

Manufactured By: RASMUSSEN IRON WORKS, INC.
12028 E. Philadelphia Street
Whittier, California 90601

CONSUMER RECORD CARD

Fill in blanks below for your permanent record.

DATE PURCHASED _____

MODEL NO. _____

DATE INSTALLED _____

SERIAL NO. _____

INSTALLED BY: _____

GAS TYPE: _____

DEALER: _____

PARTS LIST C2A/C2B (MANUAL/SWITCH/REMOTE)

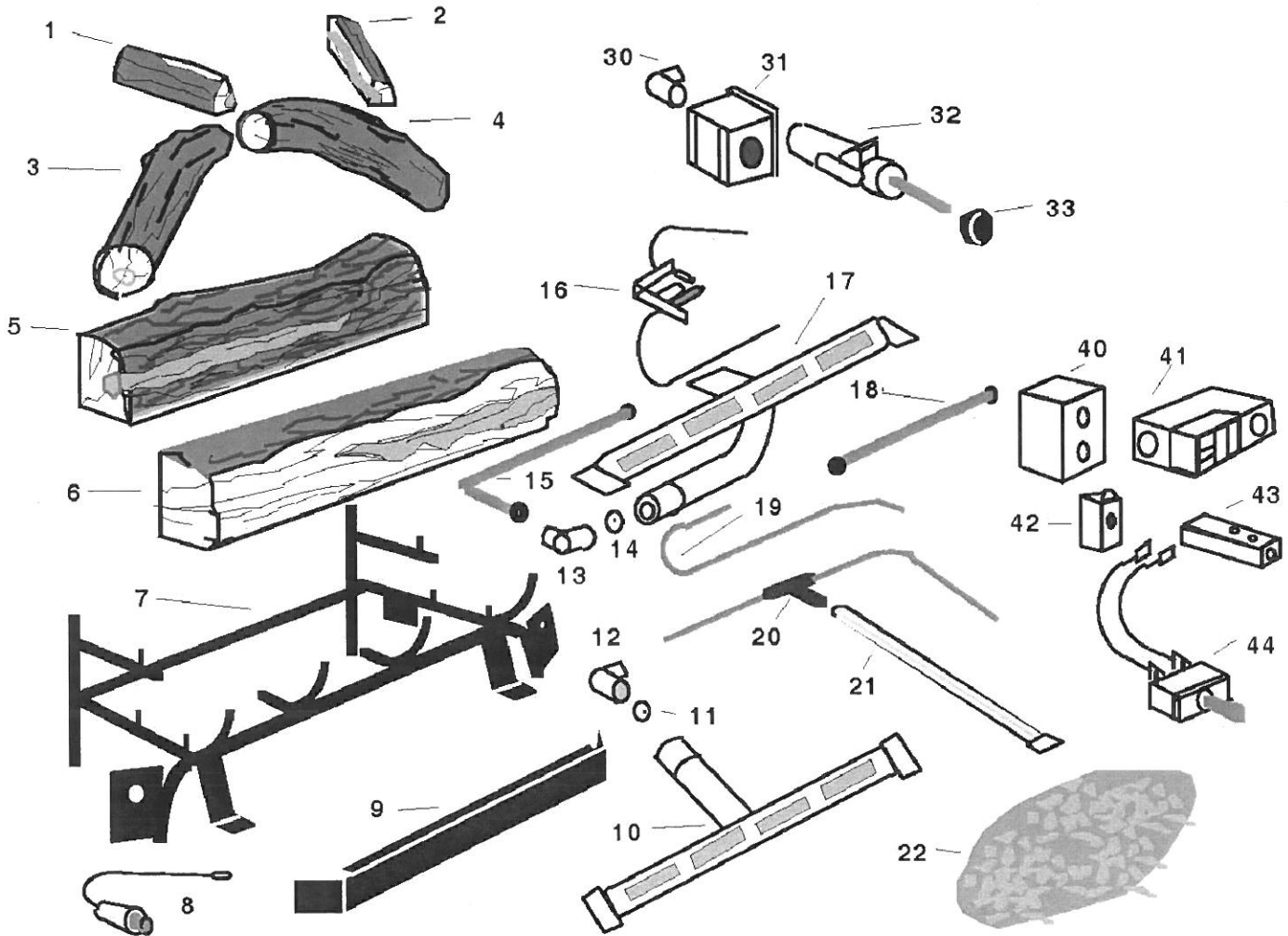

1. Top Log Small (Left)
2. Top Log Small (Right)
3. Top Log Large (Left)
4. Top Log Large (Right)
5. Rear Log
6. Front Log
7. Grate
8. Push Button Piezo Ignitor
9. Ember Tray
10. Front Burner (RBT or RAT)

11. Front Burner Orifice (N) or (LP)
12. Front Burn. Orifice Holder
13. Rear Burner Orifice Holder
14. Rear Burner Orifice (N) or (LP)
15. Rear Burner Manifold Tubing 3/8"
16. O.D.S. Assembly (N) or (P) (MV) or Standard)

17. Rear Burner (038 or CH-5)
18. Supply Manifold Tubing 3/8"
19. Pilot Manifold Tubing
20. Carry Over Tube TEE and Orifice Assembly with 1/4" Manifold Tubing
21. Carryover Tube
22. Ember Material

- C2-A/B-M (Manual)**
30. IRegulator Input Fitting
 31. Regulator (N) or (P)
 32. Manual Valve
 33. Valve Knob
- C2-A/B-S/R (Switch/Remote)**
40. Remote Box and Cover
 41. Gas Valve (S & R Model)
 42. Receiver (R Model)
 43. Transmitter (R Model)
 44. 3 Way Switch (S Model)

TWO YEAR CONSUMER PRODUCT WARRANTY

The following warranty has been drafted to comply with the MAGNUSON-MOSS WARRANTY ACT applicable to products manufactured after July 4, 1975, It replaces and supersedes any warranty in this package or in any printed literature.

LIMITED WARRANTY:

RASMUSSEN IRON WORKS INC, 12028 E. Philadelphia Street, Whittier California, U.S.A., warrants this Gas Fire Set and accessories against defects in materials and workmanship, and suitable for a particular purpose, for a period of:

- (1) OBJECT CASTING - All logs are guaranteed against burnout in the original installation for 2 years from the date of initial purchase.
- (2) BURNERS, SHEET METAL, SAFETY CONTROLS AND ALL OTHER COMPONENTS - 2 Years from date of initial purchase.

When used in an outdoors or commercial installation, the warranty period shall be six (6) months. Warranty does not extend to corrosion of parts used in outdoor environment.

THIS WARRANTY IS FOR THE BENEFIT OF THE ORIGINAL PURCHASER.

WARRANTY ADJUSTMENT:

- (1) RASMUSSEN agrees to repair or furnish a replacement for, but not remove or install any product or component which proves defective within the above warranty and appropriate time periods stated.
- (2) BUYER notify RASMUSSEN of any defect within this warranty no later than thirty (30) days after a defect is discovered.
- (3) No product will be accepted for return or replacement without written authorization of RASMUSSEN. Before returning merchandise, write to RASMUSSEN Giving us full details of the complaint and a copy of the sales receipt or other evidence of the purchase date. Merchandise returned without proof of purchase date will be serviced out-of-warranty at our prevailing service and parts rates. If merchandise was damaged in transit, the file claim must be addressed as follows:

**RASMUSSEN IRON WORKS INC
12028 E. PHILADELPHIA STREET
WHITTIER, CALIFORNIA 90601**

**Shipping charges must be pre-paid by the buyer.
REPAIR OR REPLACEMENT UNDER THIS WARRANTY
WILL BE SHIPPED FREIGHT COLLECT.**

EXCLUSIONS FROM WARRANTY:

- (1) The foregoing warranty is limited solely as set forth herein and

applies only for the designated above.

- (2) RASMUSSEN shall not be liable for any loss, damage incidental or consequential damages of any kind, whether based upon warranty, contract, or negligence, arising in connection with the sale, use or repair of the product. Some states do not allow the exclusion or limitation of incidental or consequential damages, so the above limitation or exclusion may not apply to you.
- (3) The maximum liability of RASMUSSEN in connection with this limited warranty shall not in any case exceed the contract price paid for the product claimed to be defective or unsuitable.
- (4) This warranty does not extend to any product manufactured by RASMUSSEN which has been subjected to misuse, neglect, accident improper installation, or use in violation of instructions furnished by RASMUSSEN. Do not remove Rating Plate/Warning Tags. These tags serve you and any future user as an integral Safety and identification component of the CHILLBUSTER gas log heater. Removing these tags voids the warranty.
- (5) This warranty does not extend to or apply to any unit which has been repaired or altered in any place other than RASMUSSEN IRON WORKS INC. factory, or by persons not expressly approved by RASMUSSEN.
- (6) Components manufactured by any supplier other than RASMUSSEN shall bear only that warranty made by the manufacturer of that product.
- (7) Freight damage, cracking from thermal shock, and color changes occur from causes beyond manufacturer's control and are not covered by any warranty.

THIS WARRANTY GIVES YOU SPECIFIC LEGAL RIGHTS, AND YOU MAY ALSO HAVE OTHER RIGHTS WHICH VARY FROM STATE TO STATE.

RASMUSSEN IRON WORKS, INC. shall be held harmless from any and all claims by the buyer as a result of injury or damage to an ultimate user or other person caused by the product sold herein by the seller to the buyer, whether the injury or damage results from the assembly, product installation, operation, shipment, storage or manufacture of this product. RASMUSSEN IRON WORKS, INC makes no warranties, expressed or implied, other than those expressly stated herein.

CONSUMER RECORD CARD

**FOR CUSTOMER RECORDS ONLY.
DO NOT SEND THIS CARD TO MANUFACTURER**



LOG MODEL: _____

SAFETY CONTROL: _____

DATE OF PURCHASE: _____

DEALER: _____

INSTALLER: _____