



Rasmussen[®]
GAS LOGS & GRILLS

12028 E. PHILADELPHIA ST.
 WHITTIER, CA CALIFORNIA 90601 U.S.A.
 www.rasmussen.biz

REV RFLD.
 Last Printed. 9/9/2020 8:52 AM

ATTENTION! READ INSTRUCTIONS CAREFULLY BEFORE ASSEMBLY OR USE

Models; RF-LD 30/36, 42/48, 60/72 – VEI-Natural Gas (-N) or Propane (-P)

- 18"** Manzanita, LoneStar, CrossFire, Prestige Oak, Birch, Frosted Oak.
- 20"/21"** Evening Prestige, Evening Desire, Evening CrossFire, Evening Campfire, Evening LoneStar, CrossFire and TimberFire
- 24"** Frosted Oak, Birch, Prestige Oak, CrossFire, LoneStar, Manzanita, TimberFire, Evening Lone Star, Evening Prestige, Evening Desire, Evening CrossFire, Evening Campfire.
- 30"** Frosted Oak, Birch, Prestige Oak, CrossFire, LoneStar, Manzanita, TimberFire, Evening Lone Star, Evening Prestige, Evening Desire, Evening CrossFire, Evening Campfire.

WARNING: If the information in this manual is not followed exactly, a fire or explosion may result causing property damage, personal injury or loss of life.

- Do not store or use gasoline or other flammable vapors and liquids in the vicinity of this or any other appliance.
- **WHAT TO DO IF YOU SMELL GAS**
 - Do not try to light any appliance.
 - Do not touch any electrical switch; do not use any phone in your building.
 - Immediately call your gas supplier from a neighbor's phone. Follow the gas supplier's instructions.
 - If you cannot reach your gas supplier, call the fire department.
- Installation and service must be performed by a qualified installer, service agency or the gas supplier.

INSTALLER: Leave this manual with the appliance.
CONSUMER: Retain this manual for future reference.

Improper installation, alteration, service or maintenance can cause property damage, personal injury or loss of life. Read these instructions thoroughly before installation. For assistance or additional information, consult your gas log dealer, qualified installer, service agency or gas supplier.

This appliance may be installed in an aftermarket, permanently located, manufactured (mobile) home, where not prohibited by local codes.

This appliance is only for use with type of gas indicated on the rating plate.

Installation must conform with local codes or, in the absence of local codes, with the National Fuel Gas Code, ANSI Z223.1/NFPA 54.

In the Commonwealth of Massachusetts:

- Installation must be performed by a licensed plumber or gas fitter.
- The chimney flue damper, when used with gas logs, will be welded open or completely removed.
- A CO detector shall be installed in the room where the appliance is installed.

WARNING

This is a vented gas appliance for use only in a solid-fuel burning fireplace constructed on non-combustible material with a fully functional chimney flue which must vent all of the products of combustion.
WHEN OPERATING, THE CHIMNEY DAMPER MUST BE FULLY OPEN

MINIMUM FIREPLACE FLUE REQUIREMENTS

The minimum permanent free opening of the fireplace chimney or chimney damper must be at least the minimum chimney area shown on the chart on page 6, based on a minimum chimney height of at least 8 feet. The area of the flue must not be less than 1/10 the area of the fireplace opening. **The flue must exhaust all products of combustion.**

WARNING: Failure to position the parts in accordance with the diagrams in this manual or failure to use only parts specifically approved with this appliance may result in property damage or personal injury.

The installation and the provisions for combustion and ventilation air must conform with *The National Fuel Gas Code ANSI Z223.1 / NFPA54*, or *The CSA B149.1, Natural Gas and Propane Installation Code*, latest edition.

IMPORTANT INFORMATION

- **Due to high temperatures**, the appliance should be located out of traffic and away from furniture and draperies.
- **Children and adults** should be alerted to the hazard of high surface temperatures and should stay away to avoid burns or clothing ignition.
- **Young children** should be carefully supervised when they are in the same room with the appliance.
- **Do not place** clothing or other flammable material on or near the appliance.
- **Any safety screen** or guard removed for servicing an appliance must be replaced prior to operating the appliance.
- **Installation and repair** should be done by a qualified service person. The appliance should be inspected before use and at least annually by a professional service person. More frequent cleaning may be required due to excessive lint from carpeting, bedding material etc. It is imperative that control compartments, burners and circulating air passageways of the appliance be kept clean.
- **WARNING:** Any change to this appliance or its controls can be dangerous.
- **WARNING:** Failure to keep the primary air opening(s) of the burner clean may result in sooting and property damage.
- **Keep appliance area** clear and free from combustible materials, gasoline and other flammable vapors and liquids.
- **DO NOT** use this room appliance if any part has been under water. Immediately call a qualified service technician to inspect the appliance and to replace any part of the control system and any gas control that has been under water.
- **WARNING:** Before installing in a solid-fuel burning fireplace, the chimney flue and firebox must be cleaned of soot, creosote, ashes and loose paint by a qualified chimney cleaner.
- **WARNING:** Do not allow fans to blow directly into the fireplace. Avoid any drafts that alter burner flame patterns.
- **WARNING:** Do not use a blower insert, heat exchanger insert or any other accessory not approved for use with this heater.
- **A fireplace screen** must be in place when the appliance is operating and, unless other provisions for combustion air are provided, the screen shall have an opening(s) for introduction of combustion air.
- **Solid fuels** shall not be burned in a fireplace where this appliance is installed.
- **WARNING:** Glass doors must be fully opened when appliance is in operation to allow for safe combustion, cooling of components and venting.
- **Any outside air ducts** and/or ash dumps in the fireplace shall be permanently closed at the time of appliance installation.
- This appliance may be used in sleeping quarters and bathrooms if used in a vented application, subject to local codes.
- **Avoid contact** with the objects, chassis or another part which may be hot during operation.
- **RF-LD burner** should **not be installed** in a Direct vent, B-Vent and or Vent free fireplace.
- Log set is designed to **burn with yellow flames**; thus **adequate ventilation** is absolutely necessary.

Your gas log set is assembled at the factory to be installed in a fireplace plumbed with the gas supply on the right side (facing unit). DO NOT convert to the left side of burner. Instead, run a connecting pipe or aluminum flex connector (per local codes) behind burner along the back wall of fireplace bringing your gas line to the right side.

CARBON MONOXIDE POISONING MAY LEAD TO DEATH

When used without fresh air, decorative gas appliances may give off carbon monoxide, an odorless, colorless, poisonous gas. Some people, pregnant women, persons with heart or lung disease, anemia, persons under the influence of alcohol and persons who live at high altitudes are more affected by carbon monoxide than others.

Early signs of carbon monoxide poisoning resemble the flu and include; headache, dizziness and/or nausea. If you have these symptoms, the burner or the appliance may not be installed or working properly, or the flue may be blocked. GET FRESH AIR AT ONCE! Verify that the gas log set is properly arranged and have the heater and chimney flue serviced before using again.

WARNING

During manufacturing, assembly and packaging, various components of this appliance are exposed to certain oils or films. These are not harmful but may produce annoying smoke and smells as they are burned off during the initial operation of the appliance, possibly causing headaches, eye or lung irritation. This is a normal occurrence and only temporary. The initial break-in operation should last 2-3 hours with the burner at the highest setting. Provide maximum ventilation by opening windows, doors and the chimney flue (if using a vented model) to allow odors to dissipate. The only odor remaining after this initial break-in period will be the normal odors associated with the combustion of Natural or Propane Gas and/or related to your indoor environment (see page 10).

WARNING—Proposition 65 Statement

If not installed, operated and maintained in accordance with these instructions, this product could expose you to substances in fuel or from fuel combustion which are known to the State of California to cause cancer, birth defects or other reproductive harm.

PARTS LIST

REQUIRED TOOLS AND MATERIALS

Adjustable Wrench and Pipe Wrench. Pipe Sealing compound is **required** if fittings not already pre-threaded with Teflon tape to prevent gas leaks. **DO NOT** use Teflon tape or pipe compound on other tapered fittings.

1. Burner Grate Assembly (RF-LD60//72, RF-LD 42/48, RF-LD30/36)
2. Rating/I.D. Plate
3. Flex Connector (SSCB-14)
4. 3/8" x 1/2" FIP Flared Brass Fitting (A1)
5. Orifice Spud (see page 12 for size)
6. Orifice Holder (Internally Tapped 3/8" x 3/8" Flared MIP Fitting) (A2T)
7. Air Mixer for **Propane** Gas burners (MA2)
8. Damper Clamp (DC1)
9. White Silica Sand (Natural Gas burners)
10. Ember Magic (EMX1)
11. Black Volcanic Ash (Propane burners)
12. Flex Connector (SSCB-12-18)
13. 1/2" Flared x 1/2" MIP brass elbow
14. 1/2" Male flared x 1/2" MPT Half Union
15. 1/2" Close Nipple
16. 1/2" 90 degree Street Elbow
17. 1/2" 90 degree Elbow
18. Orifice spud Holder 3/8" x 3/8"
19. 1/2" x 3/8" hex bushing
20. 1/2" Black Tee Fitting
21. Orifice Chart

The construction of your RF-LD burner may differ slightly depending on whether it is Natural Gas or Propane and on which type of safety control mechanism and valve is used.

Picture of burners Natural & Propane



RF-LD60/72-N/P
(7 SQUARE BARS)



RF-LD42/48-N/P
(5 SQUARE BARS)



RF-LD30/36-N/P
(4 SQUARE BARS)



(21)

Match lite	(-N)NG Orifice(s)	btus	(-P) LP Orifice(s)	btus
RF-LD30/36-VEI-	Top 32 Bottom 48	50k	Top 53 Bottom 59	35k
RF-LD42/48-VEI-	Top 25 Bottom 28	60k	Top 51 Bottom 57	50k
RF-LD60/72-VEI-	Top 1/4 Bottom 30	85k	Top 45 Bottom 53	80k

PARTS LIST (Cont'd)

- | | |
|--|--|
| <p>22. GV60 Electronic Ignition Gas Valve (GV60-VNG(Natural gas) (GV60-VLP(Propane)</p> <p>23. Remote / Transmitter, Variable Height Control (GV60-TXB)</p> <p>24. Module / Receiver(GV60-RXA)</p> <p>25. Interrupter Block(GV60-TIA)</p> <p>26. Ignition Cable (GV60-ICA)</p> <p>32. RF-LD30/36, 42/48, 60/72 Valve Vanisher</p> | <p>27. Interrupter Receiver Cable (GV60-RCA)</p> <p>28. On / Off Switch Cable (GV60-SWA)</p> <p>29. 8 Wire Cable (GV60-C8)</p> <p>30. GV60 Battery Box / Cable (GV60-BCA)</p> <p>31. Plug in Adapter for AC Power Supply (GV60-AC)</p> <p>33. Hard wire wall switch (GV60-SW1)</p> |
|--|--|

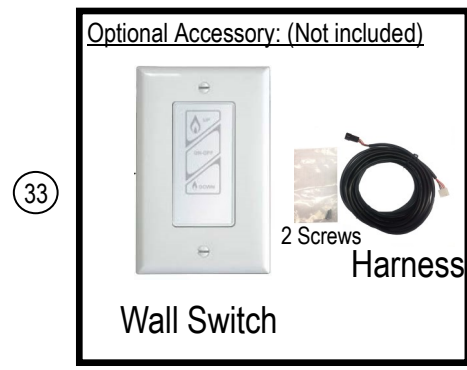
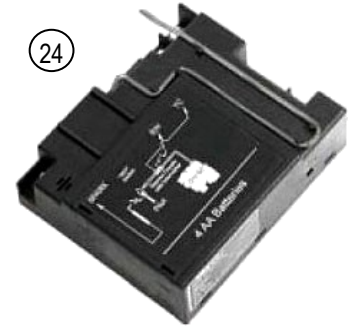

GENERAL INSTALLATION INSTRUCTIONS

WARNING: Failure to position the parts in accordance with these diagrams or failure to use only parts specifically approved with this appliance may result in property damage or personal injury.

The appliance and its appliance main gas valve must be disconnected from the gas supply piping system during any pressure testing of that system at test pressures in excess of 1/2 psi. The appliance must be isolated from the gas piping system by closing its equipment shutoff valve during any pressure testing of the gas supply piping system at test pressures equal to or less than 1/2 psi.

Natural Gas Operating Pressures: Minimum inlet gas supply pressure = 6 inches of water column. Maximum inlet gas supply pressure is 7 inches of water column. **Propane Gas Operating Pressures:** Minimum inlet gas supply pressure = 11 inches of water column. The maximum inlet gas supply pressure is 14 inches of water column.

STEP ONE PREPARATION:

1. Verify that the Valve Assembly is correctly matched to the log set, burner, and gas supply.
2. Turn off **Fireplace Gas Supply** (Figure 1A).
3. Thoroughly clean fireplace floor of any ashes and have a qualified chimney cleaner insure that the chimney flue and firebox are free of soot, creosote, and loose paint.
4. Attach **Damper Clamp** (Figure 2A) over edge of fireplace **Damper Blade** (Figure 2B) to prevent damper from fully closing accidentally. If unable to attach damper clamp, drill a hole (or holes) in the damper or remove it completely.

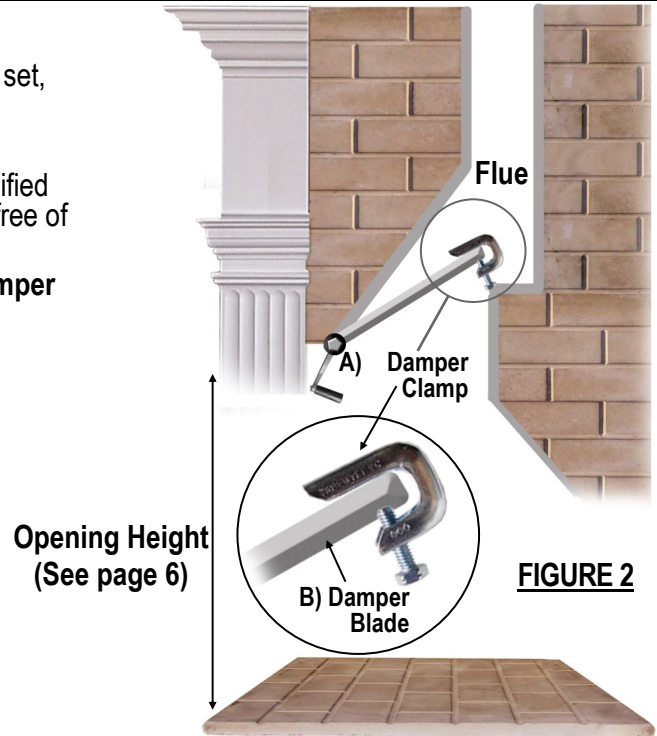
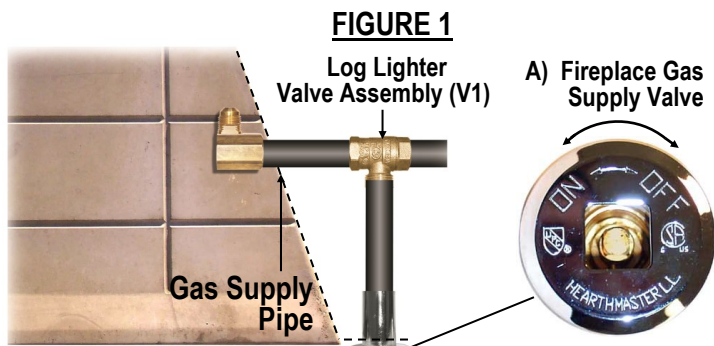

- RF-LD burner should not be installed in a Direct vent, B-Vent and or Vent free fireplace.
- Log set is designed to burn with yellow flames; thus adequate ventilation is absolutely necessary.

In the Commonwealth of Massachusetts:

- Installation must be performed by a licensed plumber or gas fitter.
- The chimney flue damper, when used with gas logs, will be welded open or completely removed.
- A CO detector shall be installed in the room where the appliance is installed.

IMPORTANT:

THE CHIMNEY DAMPER MUST BE WIDE OPEN AND FIXED IN A MANNER TO MAINTAIN A PERMANENT FREE OPENING AT ALL TIMES AS OUTLINED ABOVE. THE AREA OF THE FLUE MUST BE NOT LESS THAN 1/10 THE AREA OF THE FIREPLACE OPENING. THIS GAS LOG SET MUST BE INSTALLED IN A FULLY VENTED METAL OR MASONRY FIREPLACE WITH A WORKING FLUE THAT IS SAFE FOR BURNING A WOOD FIRE. THE FLUE MUST BE FREE OF ANY OBSTRUCTIONS AND MUST EXHAUST ALL PRODUCTS OF COMBUSTION. DAMPER AND GLASS DOORS MUST BE FULLY OPEN BEFORE LIGHTING OR BURNING FOR PROPER VENTILATION AND TO PREVENT HEAT DAMAGE TO THE VALVE.

WARNING! CHECK FOR PROPER VENTING

A properly sized, unobstructed chimney will normally vent all products of combustion. Any odor or smoke detected inside the room is an indication that the flue is not functioning properly.

SHUT OFF THE BURNER IMMEDIATELY! THE CAUSE OF THE VENTING PROBLEM MUST BE DISCOVERED AND CORRECTED BEFORE CONTINUED USE OF THE GAS LOG SET.

Continued use with improper venting may cause damage to your fireplace, room furnishings and could cause serious illness. **IF IMPROPER VENTING IS SUSPECTED, IMMEDIATELY HAVE LOG SET AND CHIMNEY FLUE SERVICED.**

The installation and the provisions for combustion and ventilation air must conform with *The National Fuel Gas Code ANSI Z223.1 / NFPA54*, or *The CSA B149.1, Natural Gas and Propane Installation Code*, latest edition.

RF-LD MULTIBURNER INSTALLATION AND GAS SUPPLY CONNECTION

STEP TWO: BURNER INSTALLATION AND GAS SUPPLY CONNECTION

1. Place **Burner-Grate Assembly** inside the firebox, centered from left to right, within 1" to 2" of rear wall (Figure 3A).
2. Insure that the Gas Supply to the Fireplace is turned off. Verify correct gas type and proper gas pressures.
3. Thread **1/2" FIP x 3/8" Flared Elbow** (Figure 3B) onto the **Gas Supply Pipe** (Figure 3C) and wrench tighten.
4. Thread one end of the supplied **Flex Connector** (Figure 3D) to the **Valve Input** (Figure 3E), then connect the other end to the 1/2" FIP x 3/8" Flared Elbow attached to the Gas Supply Pipe. If Flex Connector is bent into too small a radius it may kink or break causing air flow noise and/or gas leaks.

FIGURE 3

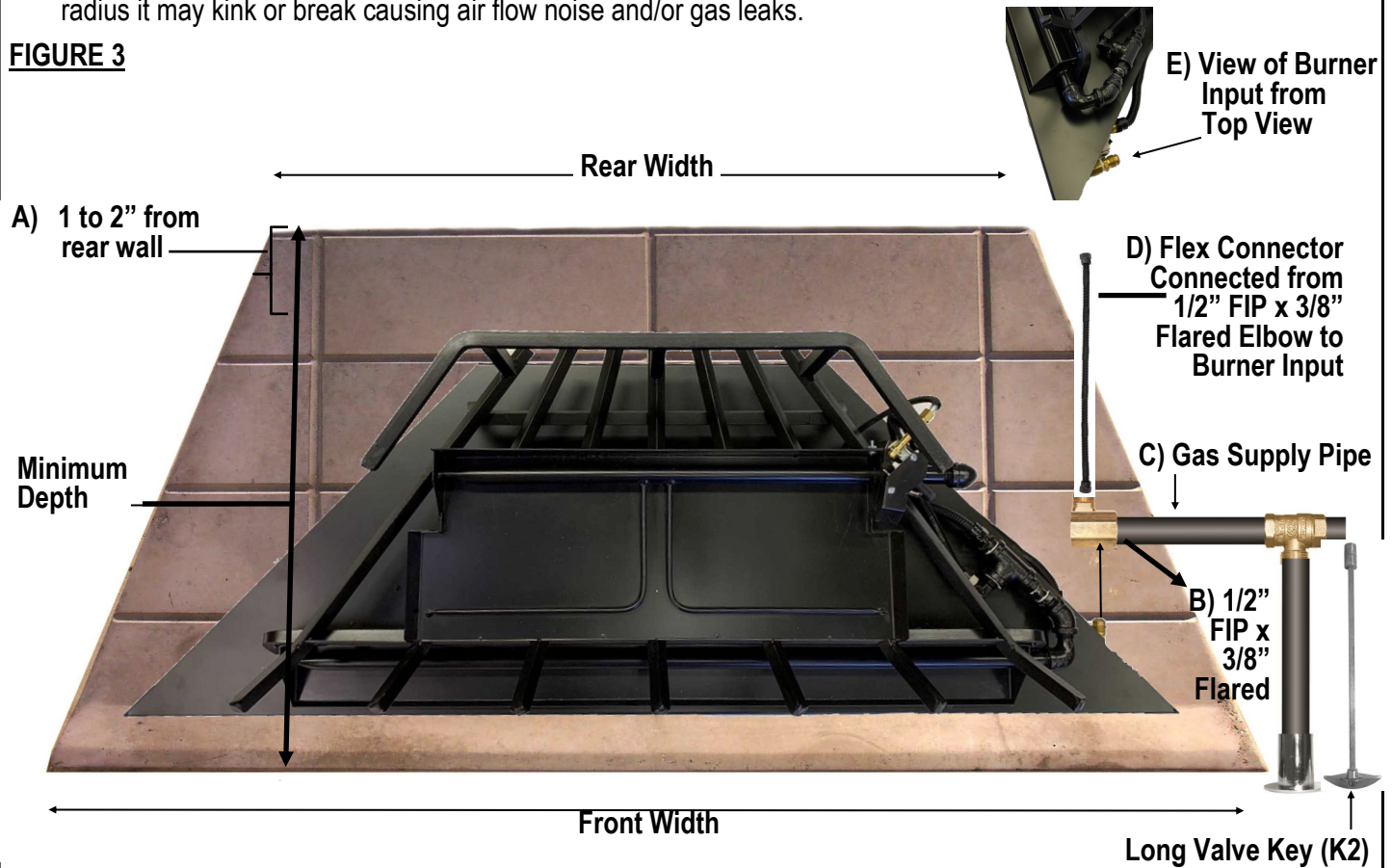

WARNING: Failure to position the parts in accordance with these diagrams or failure to use only parts specifically approved with this heater may result in property damage or personal injury.

MINIMUM FIREPLACE FLUE REQUIREMENTS

The minimum permanent free opening of the fireplace chimney or chimney damper must be at least the minimum Chimney Area shown below, based on a minimum chimney height of at least 8 feet. The area of the flue must not be less than 1/10 the area of the fireplace opening. **The flue must exhaust all products of combustion.**

The chimney damper must be fixed in a manner to maintain permanent free opening as outlined on the previous page (Figure 2) at all times. To accomplish this, install the damper clamp (provided) on the edge of the damper blade to prevent its closing, drill a hole or holes in the damper, or remove damper completely. The minimum size of the fireplace in which the log set is to be installed must be as follows:

Model Number	Log Set Size	Opening Height	Firebox Depth	Front Width	Rear Width	Min. Chimney Opening Diameter	Btu./Hour Natural Gas (N)	Max. Input Propane (P)
RF-LD30/36-VEI-N/P	18"	28	12	30	13.5	7"	50k	35k
RF-LD30/36-VEI-N/P	20" / 21"	32	14	36	13.5	7"	50k	35k
RF-LD42/48-VEI-N/P	24"	38	15	42	15	8"	60k	60k
RF-LD42/48-VEI-N/P	24"	42	16	48	18	8"	60k	60k
RF-LD60/72-VEI-N/P	30"	45	20	60	22.5	9"	85k	80k
RF-LD60/72-VEI-N/P	36"	45	24	72	24	10"	85k	80k

PAN MEDIUM

(Amount supplied will vary with each size and style of burner)

STEP ONE: Completely cover **Burner Pipes** (Figure 4A and Figure 5A) and **Ember Booster** (Figure 4B and Figure 5B) with Pan Medium starting from rear of burner pan and moving toward leading edge. Use entire contents of bag provided, allowing medium to spill over leading edge of burner pan (Figure 4C and Figure 5C). If using a Natural Gas burner the Pan Medium used will be White Sand as shown in Figure 4. If using a Propane Gas burner, the Pan Medium used will be Volcanic Ash, as shown in Figure 5. If using a Natural Gas model, the Volcanic Ash supplied can be used as dressing for the firebox floor (See page 9). **NEVER** use White Sand inside a propane gas burner.

NOTE: When installing a propane model insure that the air mixer hole is not blocked or covered.

FIGURE 4

Natural Gas (Sand and Embers Only)

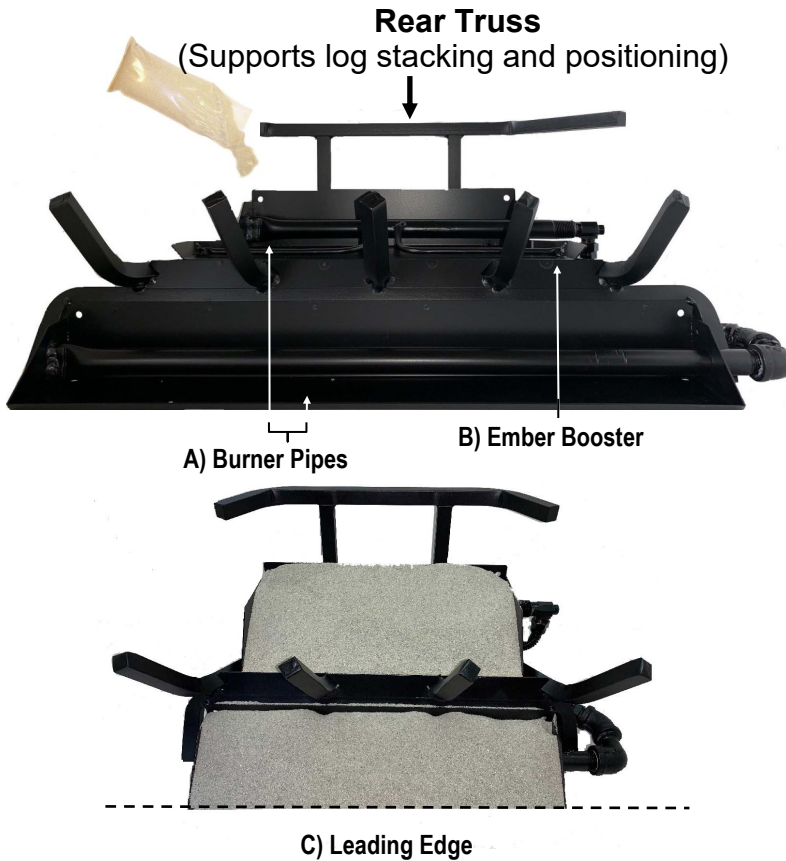
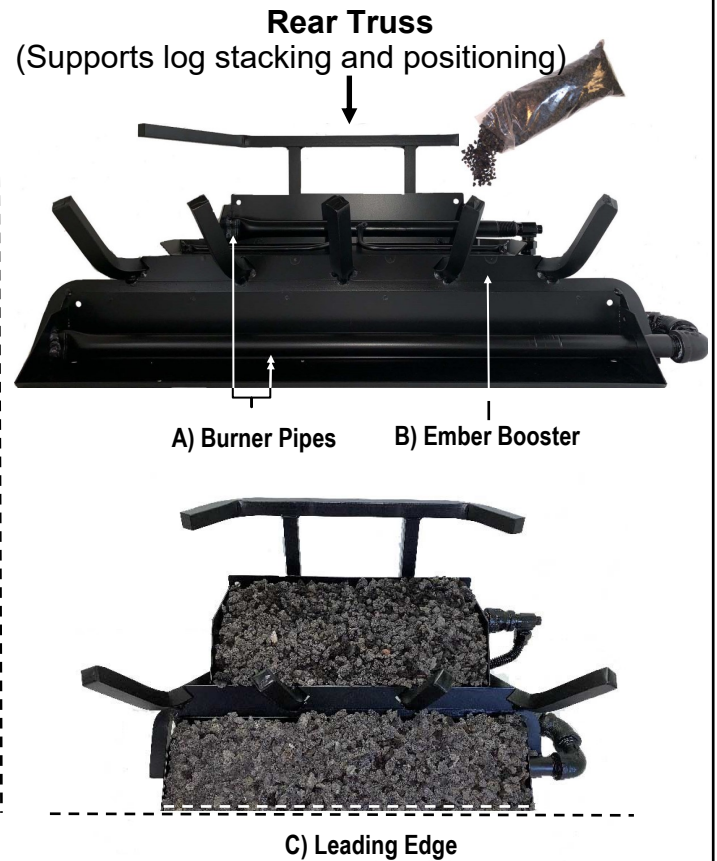

FIGURE 5

Propane Gas (Volcanic Ash and Embers Only)



STEP TWO: Sprinkle a light covering of “Ember Magic” over the Pan Medium (Figure 6A and Figure 6B). Pull apart “Ember Magic” fiber material to enhance the glowing ember effect. Spread remaining “Ember Magic” around ends of pan to add to the ember bed appearance. When done the Burner pan should look somewhat like the illustration below. (See page 9 also)

FIGURE 6

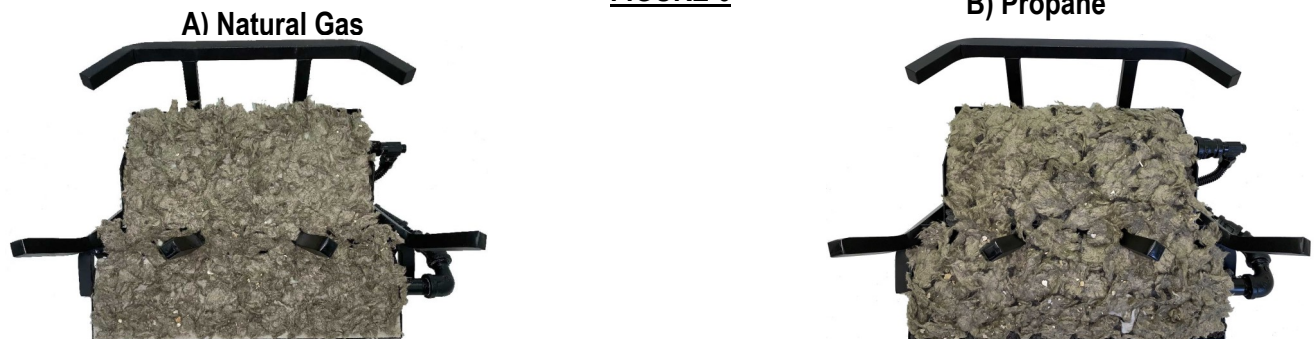

WARNING: Failure to position the parts in accordance with these diagrams or failure to use only parts specifically approved with this heater may result in property damage or personal injury.

WARNING: NEVER use White Sand inside a propane gas burner.

LOG PLACEMENT

CAUTION: Crowded logs will cause poor combustion and result in excessive soot formation.

The largest logs will be the **Front** as shown in figures 7A, 8A and 9A and **Rear Logs** will cross from front log to Rear truss. (Figures 7B, 8B and 9B.) Some log sets have two separate front logs which simulate a charred/burnt effect between the two halves (Figure 8 and Figure 9). Place the **Longest Log** or 2 largest “charred” logs if applicable (Figure 8A and 9A) as far forward on the Grate as possible. The remaining logs, or “**Top Logs**” are placed diagonally across the Front and Rear logs with the larger top logs placed first allowing flame to pass freely between them (Figure 7C thru 9C).

FIGURE 7
RF-LD30-N W/ XF18

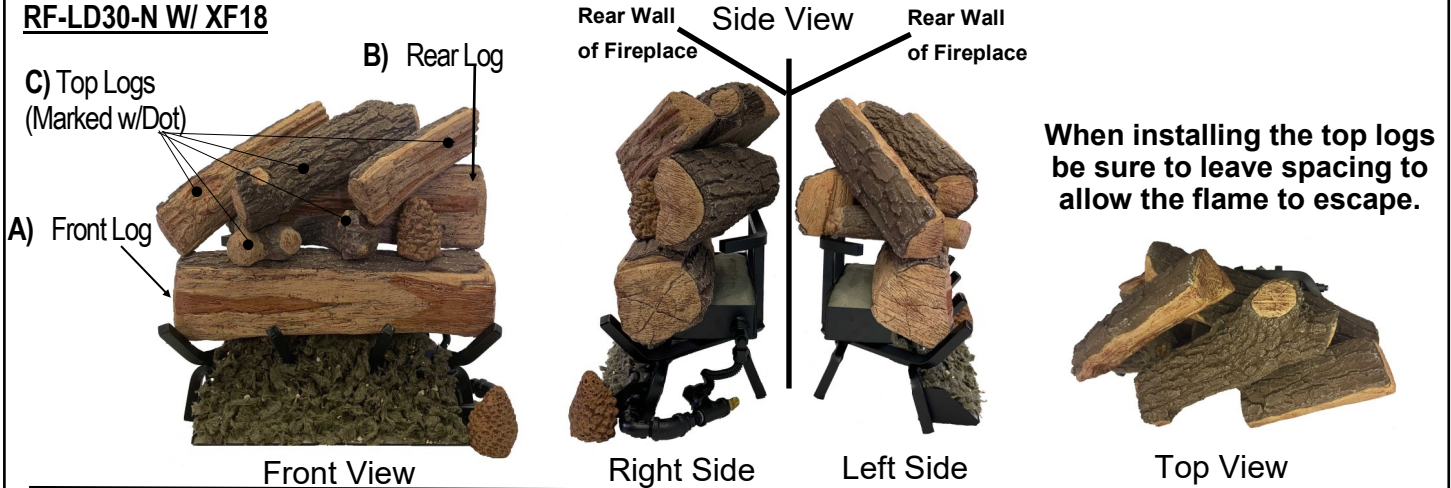

FIGURE 8
RF-LD42-N /EPR24

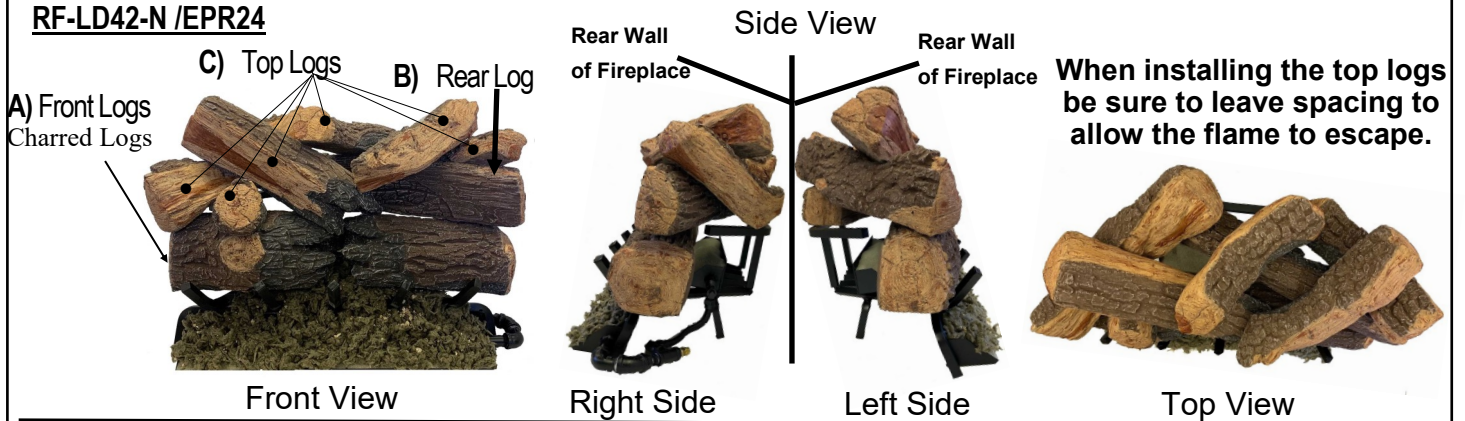
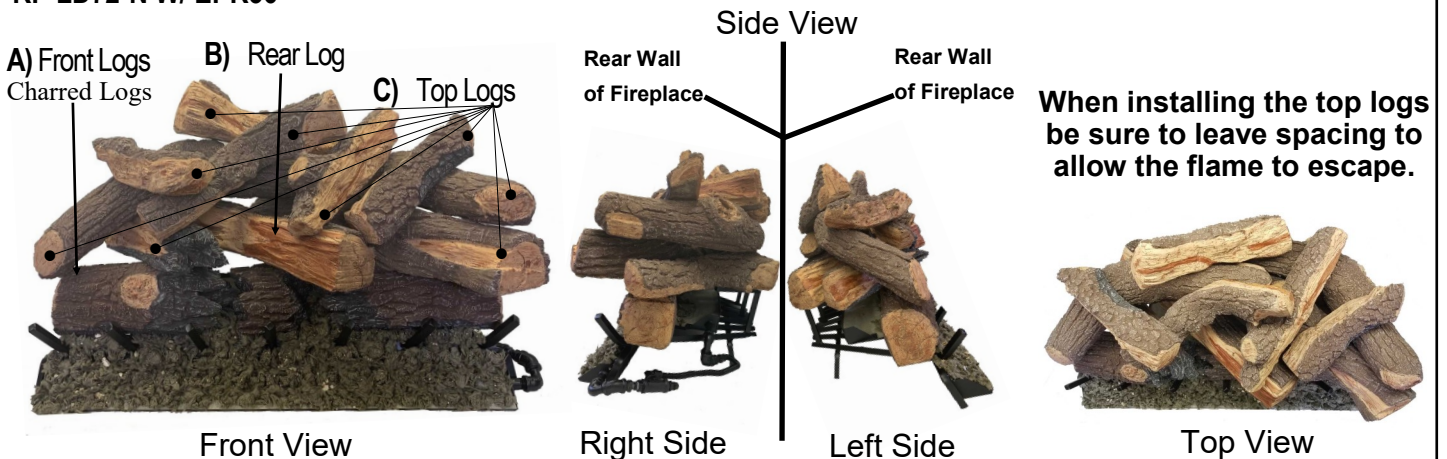

FIGURE 9
RF-LD72-N W/ EPR36



WARNING: Failure to position the parts in accordance with these diagrams or failure to use only parts specifically approved with this heater may result in property damage or personal injury.

IMPORTANT! YOUR GAS LOG SET SHOULD BE OPERATED FOR THE FIRST 2-3 HOURS AT A LOW FLAME SETTING TO ALLOW TEMPERING OF THE REFRACTORY LOGS.

PLACEMENT OF REMOTE RECEIVER

FIGURE 10

RF-LD 60/72-VEI-Propane Model below prior to log placement



FIGURE 11

Natural Gas Model shown below and How to position Battery Pack outside the fireplace.

BATTERY PACK PLACEMENT



WARNING
Battery pack needs to be installed outside the firebox and as far away as possible to assist in battery life and prevent overheating. Failure to follow these instructions can void warranty.

CAUTION:
DO NOT BLOCK AIR VENTS
DOING SO WILL OVERHEAT CONTROLS AND VOID WARRANTY
(Remove this paper before operating burner)

NOTE: Any beeping or unexpected shutdown may be the over-temperature safety feature in the receiver. If this happens, move the receiver into a cooler area, and/or use the RH2/RH3 remote house.

General information, Warnings and identification of parts

Warnings: GV60 standard version is suitable for indoor use only. Do not remove screws from the gas valve. Do not adjust and/or alter any components marked with tamper indicating paint; Motor knob is not to be removed.

Application: GV60 is a battery-powered electronic remote ignition and control system for gas appliances with pilot system. **DO NOT** connect to 115 volt line. Safety controls damaged by overheating (not following instruction manual) or 115 volt electricity are not covered by warranty. Rasmussen Iron Works, Inc. can provide a plug in Adapter for AC power supply.

We recommend that before you installed the log set you familiarize yourself with the control valve layout and operation

“VEI” VALVE / REMOTE CONTROL DISPLAY SETTINGS AND OPERATING BUTTONS

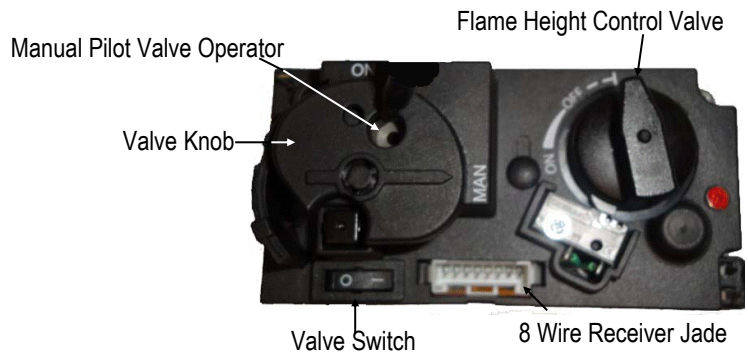

“VEI” VALVE CONTROL SETTINGS ON GAS VALVE (WHILE OPERATING WITH REMOTE / TRANSMITTER)

VALVE IN OFF POSITION

Flame height control knob turned **OFF**



Valve switch set to **0**

VALVE IN PILOT POSITION

Flame height control knob turned **OFF**



Valve switch set to **I**

VALVE IN ON POSITION

Flame height control knob turned **ON**



Valve switch set to **I**

WARNING: Any change to this appliance or its controls can be dangerous and void warranty

“VEI” VALVE CONTROL SETTINGS ON GAS VALVE FOR MANUAL OPERATION

VALVE IN OFF POSITION

Flame Height Control Knob turned **OFF**



Valve switch set to **0**

VALVE IN PILOT POSITION

Flame Height Control Knob turned **OFF**



Valve switch set to **I**

VALVE IN ON POSITION

Flame Height Control Knob turned **ON**



Valve switch set to **I**

Warning: Use only your hand to push in or turn the gas control knobs and switch. Never use tools.

LIGHTING INSTRUCTION WITH REMOTE / TRANSMITTER CONTROL

Important: For all valves, the air must dissipate and allow gas flow to pilot line before the ODS pilot will light

Batteries required:

Handset: 1 by 9V (quality alkaline recommended)



Battery Box Cable: 4 by 1.5V "AA" (quality alkaline recommended)

Setting the electronics code

NOTE: Remote will be programmed at Rasmussen Gas Logs.

(The receiver has to learn the code of the handset)

- Press and hold the receivers reset button until you hear two beeps. The first beep is short and the second beep is long. After the second beep, release the reset button.
- Within the subsequent 20 second press the  (small flame) button on the handset until you hear two additional short beeps confirming the code is set. If you hear one long beep, this indicates the code learning sequence has failed or the wiring is incorrect.

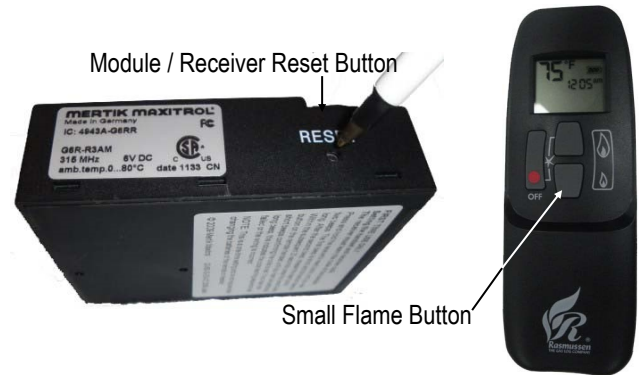

TO TURN ON THE APPLIANCE WITH REMOTE / TRANSMITTER

WARNING: When pilot ignition is confirmed, motor turns automatically to maximum flame height.

- Turn ON/OFF knob to the ON, full counterclockwise position
- Place ON/OFF switch (picture) in I (ON position). (See picture of Valve)
- Simultaneously press the OFF and  (large flame) buttons until a short beep confirms the start sequence has begun; release buttons.
 - Continuing beeps confirms the ignition is in process.
 - Once pilot ignition is confirmed, there is main gas flow.
 - After main burner ignition the valve flame height control knob will automatically go to full ON.

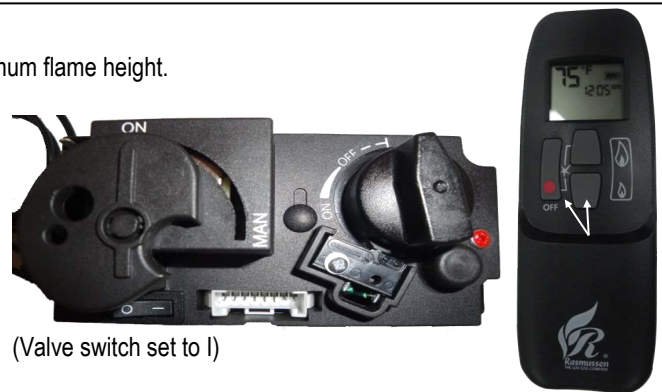

NOTE: If flame control knob turns to "ON" with no pilot flame, press OFF button on remote. Wait 5 minutes and try remote again.

TO TURN OFF THE APPLIANCE WITH REMOTE / TRANSMITTER

- Press the OFF button on the hand held remote
- Note: If remote does not turn off the burner, turn the burner off by pressing the valve switch to "O" position or by turning the flame height control knob counterclockwise to the "OFF" position.

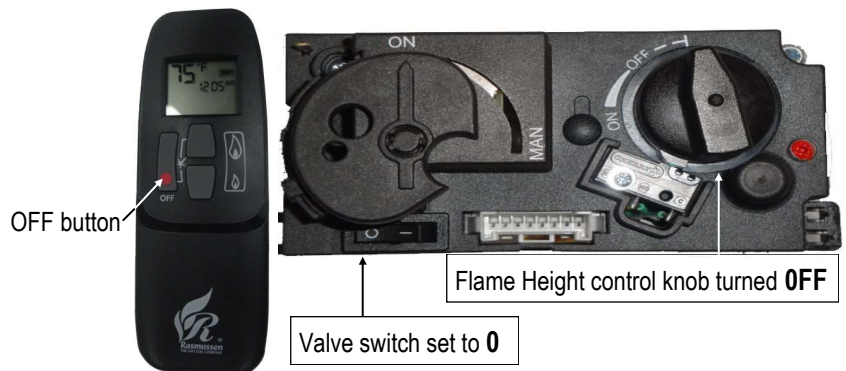

NOTE: Any beeping or unexpected shutdown may be the over-temperature safety feature in the module/receiver. If this happens, move the Battery Box Cable into a cooler area, and/or use the RH2/RH3 remote house.

LIGHTING AND OPERATION WITH REMOTE / TRANSMITTER

FLAME HEIGHT ADJUSTMENT USING REMOTE / TRANSMITTER

(Picture of transmitter with manual mode display on screen)

- In standby mode: Press and hold 🔥 (large flame) button to increase flame height
- Press and hold 🔥 (small flame) button to decrease flame height or to keep the pilot lit.
- When relighting the burner, press and hold the large flame button until flame height control knob reaches 5pm position.
- For fine adjustment tap 🔥 (large flame) of 🔥 (small flame) buttons.



Designated Low and High Fire

(1 Picture of each transmitter with Low and On display on screen)

- Double-click 🔥 (small flame) button. "LO" will be displayed.

NOTE: Flame automatically goes to designated low fire.

- Double-click 🔥 (large flame) button. "HI" will be displayed.

NOTE: Flame automatically goes to designated high fire.



Note: If the pilot flame shuts off, press the off button on the remote / transmitter and wait 5 minutes before relighting.

LIGHTING INSTRUCTION FOR MANUAL CONTROL

Note: When turning flame control knob, do not force. Knob has a slip clutch that clicks until the end stops are reached. This allows for manual flame height adjustment as well as adjustment to pilot standby position.

1. **Stop!** Read the safety information included before proceeding.
 2. Turn Flame Height Control knob to the "OFF," full clockwise position.
 3. Turn MANUAL knob to the "MAN," full clockwise position.
 4. Place ON/OFF switch in "O" (OFF position).
 5. Wait five (5) minutes for the gas to dissipate.
- If you detect gas STOP! Check for with soap and water not with open flame.**
6. Place ON/OFF switch in I (ON position) (See Valve Picture).
 7. With the valve knob in MAN position a manual pilot valve operator.
 8. Fully push down on manual pilot valve operator and hold in, to start pilot gas flow.
 9. Light pilot with a match or lighter.
 10. Once pilot is lit, continue to depress pilot valve operator and hold until the pilot flame remains lit (approximately 30 to 60 seconds).

Note: If pilot does not remain lit, depress and wait at least 5 minutes to allow gas to dissipate (Then repeat 9 & 10).

11. Turn valve knob to the "ON", full counterclockwise.
12. Turn Flame control knob to the **FULL ON**, full counterclockwise position (5pm position) (See pg. 2; Manual Operation)
13. To turn off burner and allow pilot to remain lit, turn valve knob clockwise to "MAN" position.

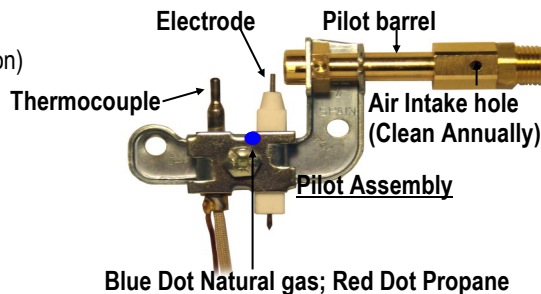
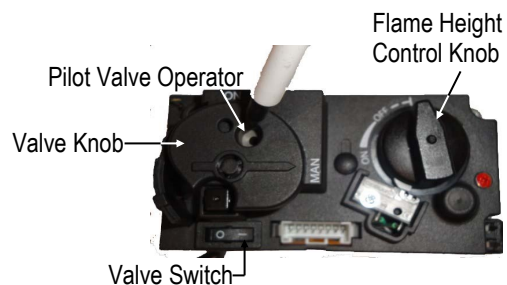

IMPORTANT SERVICE TIP! Obstructed Pilot Air Intake Ports result in an improper gas/air mixture and a weak pilot flame. **Weak pilot flame is the NUMBER 1 SERVICE ISSUE REGARDING NUISANCE SHUT-OFF.** Using canned compressed air, blow out the opposing air intake ports located at the base of the pilot. (where the gas supply line attaches to the pilot)

IMPORTANT!

KEEP BURNER AREA CLEAN AND PERFORM 3 AIR INTAKE PORTS CLEANING ANNUALLY

IMPORTANT!

PILOT ADJUSTMENT AND IMPORTANT INSTALLATION INSTRUCTIONS

PILOT FLAME ADJUSTMENT: If adjustment is necessary, use a narrow long stem screw driver to turn pilot adjustment screw. To adjust turn clockwise for less pilot flame, counterclockwise for more pilot flame.

1. The adjustment screw can be reached through the small hole in the VALVE knob.
2. Turn the VALVE knob to the **ON** position.
3. It is now possible to reach the adjustment screw beneath.
4. Turn the adjustment screw clockwise ↻ to decrease or counterclockwise ↺ to increase pilot flame.

Note: Pilot flame should be approximately 2" in length.

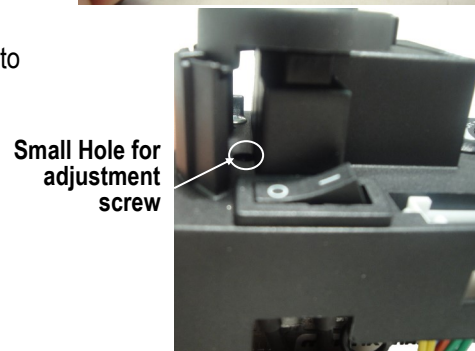
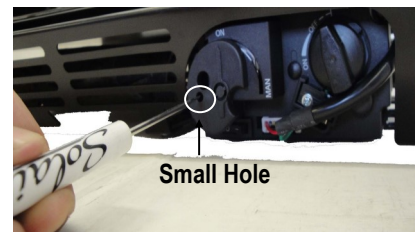

Important: For all valves, the air must dissipate and allow gas flow to pilot line before the ODS pilot will light properly.

The pilot flame should be steady and soft blue surrounding 1/8 inch of the thermocouple.

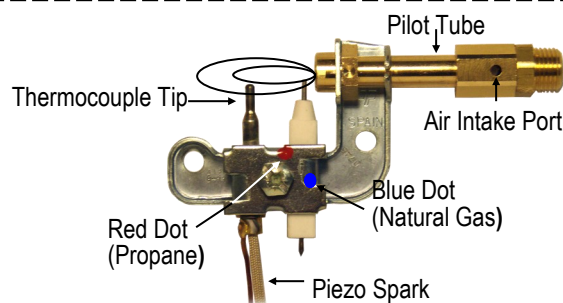

NORMAL OPERATING CHARACTERISTICS

Each and every **RF-LD Multi Burner** that leaves the factory is quality checked to ensure compliance with our certification. This check includes an operational test to ensure both satisfactory combustion and proper operation.

A normally operating RF-LD Multiburner and Log Set possess the following characteristics:

- A yellow bodied wood-like flame that will produce carbon soot. The carbon soot produced is natural and adds to the realistic appearance of the set. If the carbon becomes excessive, operate the set for ten minutes to heat the logs, then spray the sooty area with water. This dislodges the soot, which is carried up the chimney by the natural draft.
- The pilot flame should be blue in appearance.

CUSTOMER RESPONSIBILITIES AND PERIODIC MAINTENANCE

- Keep the area around the **RF-LD Multi Burner** free and clear from debris.
- From time to time, visually check pilot and burner flames for proper appearance.
- The pilot burner should be free of lint and dirt. Use a brush with stiff bristles to clean the pilot.
- The main burner should produce a relatively even flame from side to side. If the flame tends to originate from one side, the sand or volcanic ash may have become packed on the other side. When the set is off and cool, loosen the sand or volcanic ash with a wire or knife blade to allow a freer flow of gas.
- Periodically examine and clean the venting system. Once every year, a qualified agency or certified chimney sweep should examine and clean the venting system of the solid fuel burning fireplace in which the **RF-LD Multi Burner** installed (if applicable).
- The air mixer and burner must be free of lint and dirt for optimum performance. Air mixers which have been closed or are obstructed with debris will not allow sufficient combustion air into the burner. Use compressed air and/or a soft bristle brush to clean the air mixer area. **Air mixers should not be altered from factory settings.**
- Do not operate this set with any burner objects other than the **RASMUSSEN** Gas Logs specifically designed and approved for use with this Burner System.
- Do not use with blower inserts or heat exchangers.
- If used, glass doors must be wide open when burner is on.
- Do not remove Rating Plate/Warning Tags. These tags serve you and any future user as an integral safety and identification component of the **RF-LD Multi Burner** gas log heater. **Removing these tags voids the warranty.**
- **WARNING: Do not allow fans to blow directly into fireplace. Avoid any drafts that alter burner flame patterns.** Do not place blower inside area of firebox. Ceiling fans may create drafts that alter burner flame patterns. Sooting and improper burning may occur. Sooting can settle on surfaces outside the fireplace.
- Maintain pan medium inside burner pan (Pages 6) at all times.
- Maintain positioning of Gas Logs (page 8) at all times.
 - **RF-LD burner** should not be installed in a Direct vent, B-Vent and or Vent free fireplace.
 - Log set is designed to **burn with yellow flames**; thus **adequate ventilation** is absolutely necessary.

WARNING: Failure to position the parts in accordance with the diagrams in this manual or failure to use only parts specifically approved with this appliance may result in property damage or personal injury.

IMPORTANT

This **RF-LD Multi Burner** Log set is for use only in a fully functioning wood burning fireplace with the damper wide open. The flue must vent all of the products of combustion.

GAS TYPE CONVERSION

In order to convert this **RF-LD Multi Burner** decorative gas burner from Natural gas to Propane gas or vice versa, please contact Rasmussen Iron Works, Inc.

TROUBLESHOOTING

Nuisance Shutdown of Burner or Pilot/

Pilot Difficult to Light or Unable to Remain Lighted After Months or Years of Use

Most likely cause: Air in the gas line, dust intrusion under the pilot hood, low pilot flame.

Fix: Bleed gas line free of all air, blow out pilot hood, adjust pilot flame. Perform this cleaning annually or as required to prevent nuisance shutdown.

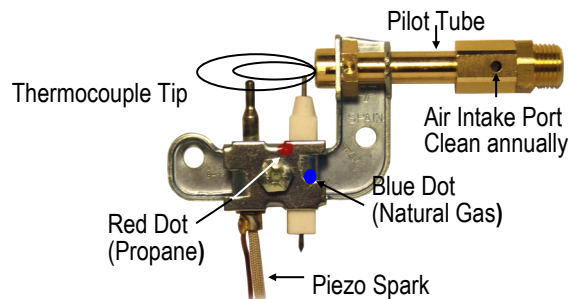

Burner is Excessively Noisy

Please Note: The movement, mixing of air and gas, and combustion will create a low, throaty sound, which is normal.

Excessive gas pressure: Make sure the gas pressure coming into the fireplace does not exceed the maximum pressure allowed with this gas set (refer to the table on pages 5).

Gas Connector: Relieve any tight bends or kinks in the Flex Connector. Switch to a smooth aluminum connector, which can be purchased at hardware or home improvement stores.

Burner Flame is Too High (8-12" Above Top Logs) or Too Low (Below Top Logs)

Incorrect gas supply, pressure, or burner orifice used: 1) Ensure gas type of set is proper for gas type being used. Make sure the gas pressure coming into the fireplace falls between the minimum and maximum pressures allowed with this gas set (refer to the table on page 6).

Blocked ports (low flame only): Free the main burner orifice and burner bar ports of any burrs, paint or other blockage.

Receiver / Module Beeps

Most likely cause: Receiver has become too hot, triggering over-temperature safety feature.

Fix: Remove Volcanic Ash from blocking or covering the slots in front of Valve Vanisher. Make sure the fireplace floor is even with the Hearth floor. Also change batteries.

Odor and/or Smoke After Break-in Period (other than Natural Odor of Gas Combustion)

Most likely causes: Lack of fresh air and/or impurities in the room air. Since the appliance is drawing its combustion air from the living area, any odors or impurities present in the room will be recycled through the flame and recirculated back into the room. Such impurities include: pet hair, fresh paint or varnish, paint remover, cigarette smoke, potpourri and incense, cements and glues, new carpet or textiles, dust build-up, and residue from previous wood burning left in the fire-box and flue, among other things.

Fix: Add fresh air. Remove sources of impurities.

NOTE—The installation of appliances in a manufactured home (U.S. only) or mobile home installation must conform with the Standard *CAN/CSA Z240 MH, Mobile Housing*, in Canada, or with the *Manufactured Home Construction and Safety Standard, Title 24 CFR, Part 3280*, in the United States, or when such a standard is not applicable, *ANSI/NCSCS A225.1/NFPA 501A, Manufactured Home Installations Standard*.

HOW TO ORDER PARTS

Parts can be ordered through the supplier from whom you purchased your RF-LD Multiburner and Log Set or from Rasmussen Iron Works, Inc. When ordering parts, please specify;

1. Model number and Serial number of the Burner (available on the Rating Plate).
2. Model number of the objects set.
3. Type of Gas (natural or propane) and control type (VSP, MVM, VEI)
4. The name of part with part number (located on parts list, page 3, 4) or specific object throughout manual.

LIMITED LIFETIME CONSUMER PRODUCT WARRANTY

The following warranty has been drafted to comply with the MAGNUSON-MOSS WARRANTY ACT applicable to products manufactured after July 4, 1975, It replaces and supersedes any warranty in this package or in any printed literature.

LIMITED WARRANTY:

RASMUSSEN IRON WORKS INC, 12028 E. Philadelphia Street, Whittier California, U.S.A., warrants this Gas Log Set and accessories against defects in materials and workmanship, and suitable for a particular purpose, for a period of:

Home (Non-Commercial use):

- (1) LOG CASTINGS - All logs are guaranteed against crumbling in the original installation for the lifetime of the initial purchaser.
- (2) BURNERS/GRATES - 2 Years from date of purchase.
- (3) SAFETY CONTROLS - Pilots and Safety Controls are covered by warranty of the original manufacturer only.

Commercial Use:

All components - 1 year from date of purchase

THIS WARRANTY IS FOR THE BENEFIT OF THE ORIGINAL PURCHASER.

WARRANTY ADJUSTMENT:

- (1) RASMUSSEN agrees to repair or furnish a replacement for, but not remove or install any product or component which proves defective within the above warranty and appropriate time periods stated.
- (2) BUYER notify RASMUSSEN of any defect within this warranty no later than thirty (30) days after a defect is discovered.
- (3) No product will be accepted for return or replacement without written authorization of RASMUSSEN. Before returning merchandise, write to RASMUSSEN Giving us full details of the complaint and a copy of the sales receipt or other evidence of the purchase date. Merchandise returned without proof of purchase date will be serviced out-of-warranty at our prevailing service and parts rates. If merchandise was damaged in transit, the file claim must be addressed as follows:

RASMUSSEN IRON WORKS INC
12028 E. PHILADELPHIA STREET
WHITTIER, CALIFORNIA 90601

Shipping

be pre-paid by the buyer.

charges must

REPAIR OR REPLACEMENT UNDER THIS WARRANTY WILL BE SHIPPED FREIGHT COLLECT.

EXCLUSIONS FROM WARRANTY:

- (1) The foregoing warranty is limited solely as set forth herein and applies only for the designated above.
- (2) RASMUSSEN shall not be liable for any loss, damage incidental or consequential damages of any kind, whether based upon warranty, contract, or negligence, arising in connection with the sale, use or repair of the product. Some states do not allow the exclusion or limitation of incidental or consequential damages, so the above limitation or exclusion may not apply to you.
- (3) The maximum liability of RASMUSSEN in connection with this limited warranty shall not in any case exceed the contract price paid for the product claimed to be defective or unsuitable.
- (4) This warranty does not extend to any product manufactured by RASMUSSEN which has been subjected to misuse, neglect, accident improper installation, or use in violation of instructions furnished by RASMUSSEN.
- (5) This warranty does not extend to or apply to any unit which has been repaired or altered in any place other than RASMUSSEN IRON WORKS INC. factory, or by persons not expressly approved by RASMUSSEN.
- (6) Components manufactured by any supplier other than RASMUSSEN shall bear only that warranty made by the manufacturer of that product.
- (7) Freight damage, cracking from thermal shock, and color changes occur from causes beyond manufacturer's control and are not covered by any warranty.

THIS WARRANTY GIVES YOU SPECIFIC LEGAL RIGHTS, AND YOU MAY ALSO HAVE OTHER RIGHTS WHICH VARY FROM STATE TO STATE.

RASMUSSEN IRON WORKS, INC. shall be held harmless from any and all claims by the buyer as a result of injury or damage to an Ultimate user or other person caused by the product sold herein by the seller to the buyer, whether the injury or damage results from the assembly, product installation, operation, shipment, storage or manufacture of this product. RASMUSSEN IRON WORKS, INC. makes no warranties, expressed or implied, other than those expressly stated herein.

* CUSTOMER RESPONSIBILITY *

Your Gas Log is designed to burn with a natural smoky yellow flame that produces carbon soot. Like a wood fire, burning a Gas Log with the flue blocked or closed will cause fumes and smoke to remain in the room and cause health hazards.

DAMPER MUST BE FULLY OPEN WHEN BURNING A GAS LOG SET.

CONSUMER RECORD CARD

Please record and retain information for future reference. Register your product at www.rasmussen.biz



LOG MODEL: _____
SAFETY CONTROL: _____
DATE OF PURCHASE: _____
DEALER: _____
INSTALLER: _____