

THR-2R INSTALLATION AND OPERATING INSTRUCTIONS

MULTI-FUNCTION WIRELESS REMOTE CONTROL SYSTEM FOR OPERATING A LATCHING SOLENOID VALVE, MANUALLY OR WITH A THERMOSTAT FUNCTION

IF YOU CANNOT READ OR UNDERSTAND THESE INSTALLATION INSTRUCTIONS DO NOT ATTEMPT TO INSTALL OR OPERATE

INTRODUCTION

This remote control system was developed to provide a safe, reliable, and user-friendly remote control system for gas heating appliances. The system is operated manually from the transmitter. The system operates on radio frequencies (RF) within a 20' range using non-directional signals. The system operates on one of 1,048,576 security codes that are programmed into the transmitter at the factory; the remote receiver's code must be matched to that of the transmitter prior to initial use.

Review **COMMUNICATION SAFETY SECTION** under TRANSMITTER section under REMOTE RECEIVER section. This signal safety feature shuts down the fireplace system when a potentially unsafe condition exists.

TRANSMITTER

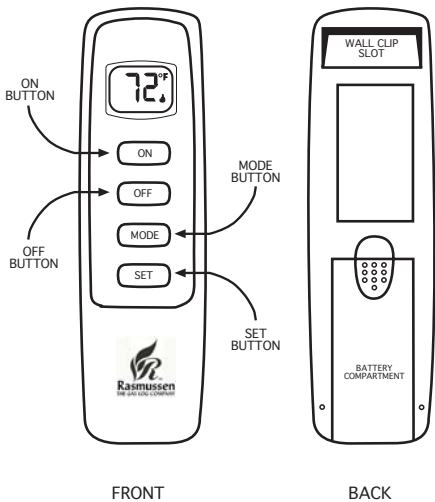

This remote control SYSTEM offers the user a battery-operated remote control to power a latching solenoid such as those used with gas valves used in some heater rated gas logs, gas fireplaces and other gas heating appliances.

The solenoid circuit uses the battery power from the receiver to operate a solenoid. The circuit has reversing polarity software which reverses the positive (+) and negative (-) output of the receiver's battery power to drive a latching solenoid ON/OFF. The SYSTEM is controlled by the remote transmitter.

The transmitter operates on a (2) 1.5V AAA batteries.

It is recommended that ALKALINE batteries always be used for longer battery life and maximum operational performance.

Before using the transmitter, install the (2) AAA transmitter batteries into the battery compartment. (Use caution that batteries are installed in the proper direction)

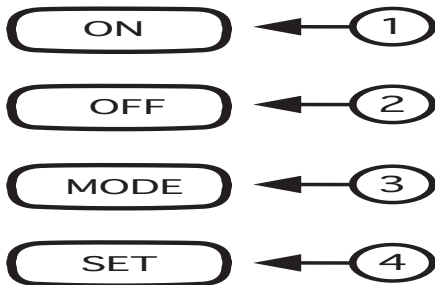

KEY SETTINGS

- ON - Operates unit to on position, Manually operated solenoid ON.
- OFF - Operates unit to off position, Manually operated solenoid OFF.
- MODE - Changes unit from manual mode to thermostat mode.
- SET - Sets temperature in thermostat mode.

LCD - Liquid Crystal Display

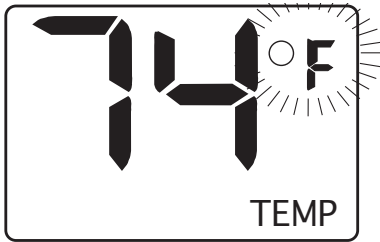
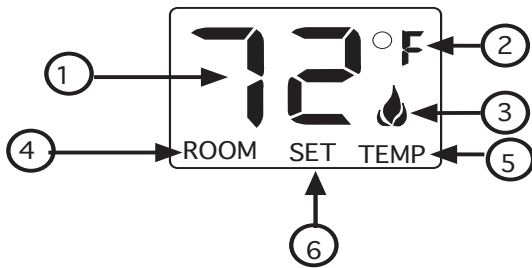

1. **DISPLAY** Indicates CURRENT room temperature .
2. **° F OR ° C** Indicates degrees Fahrenheit or Celsius.
3. **FLAME** Indicates burner/valve in operation.
4. **ROOM** Indicates remote is in THERMOSTAT operation.
5. **TEMP** Appears during manual operation.
6. **SET** Appears when setting the desired temperature for thermostat operation.

SETTING ° F / ° C SCALE

The factory setting for temperature is ° F. To change this setting to ° C:

- Press the ON key and the OFF key on the transmitter at the same time. This will change from ° F to ° C. Follow this same procedure to change from ° C back to ° F.

MANUAL FUNCTION

To operate the system in the manual "MODE" do the following.

ON OPERATION

Press the ON key - the appliance flame will come on. During this time the LCD screen will show ON. After 3 seconds the LCD screen will default to display room temperature and the word TEMP will show. **(Flame icon will appear on LCD screen in manual on mode)**

OFF OPERATION

Press the OFF key - the appliance flame will shut off. During this time the LCD screen will show OFF. After 3 seconds the LCD screen will default to display room temperature and the word TEMP will show.

THERMOSTAT FUNCTION

SETTING DESIRED ROOM TEMPERATURE

This remote control system can be thermostatically controlled when the transmitter is in the THERMOSTAT mode (The word **ROOM** must be displayed on the screen). To set the THERMOSTAT MODE and DESIRED room temperature:

Press the MODE key until the LCD screen shows the word ROOM, then the remote is in the thermostat mode.

Press and hold the SET key until the desired set temperature is reached. (By pressing and holding the set key the LCD screen set numbers will increase from 45° to 99° then restart over at 45°) Next release the SET key. The LCD screen will display the set temperature

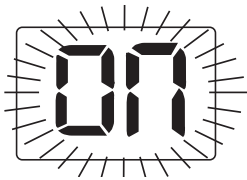

SCREEN WHILE
DEPRESSING ON
KEY

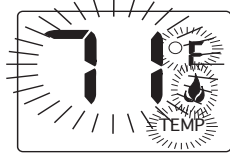

SCREEN AFTER 3
SECOND DEFAULT

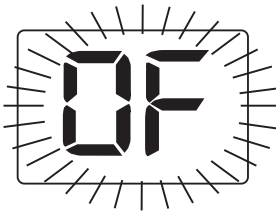

SCREEN WHILE
DEPRESSING OFF
KEY

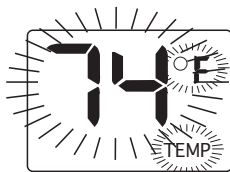

SCREEN AFTER 3
SECOND DEFAULT

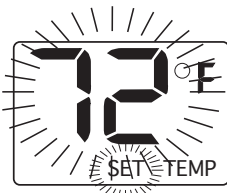

THERMO SET

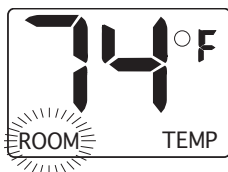

THERMO MODE

for 3 seconds and the LCD screen will flash the set temperature for 3 seconds, then the LCD screen will default to display the room temperature.

TO CHANGE THE SET TEMPERATURE

Press and hold the SET key until the desired set temperature is reached. (By pressing and holding the set key the LCD screen set numbers will increase from 45° to 99° then restart over at 45°) Next release the SET key. The LCD screen will display the set temperature for 3 seconds, then will flash the set temperature for 3 seconds, then the LCD screen will default to display the room temperature.

Press the MODE key to disengage the thermostat mode. The word ROOM on the LCD screen will not show when the thermostat is not in operation.

NOTE: The highest SET temperature is 99° Fahrenheit (32° Celsius) and the lowest temperature is 45° Fahrenheit (6° Celsius)

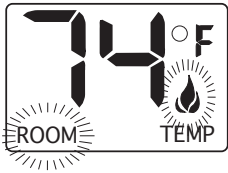

THERMO ON

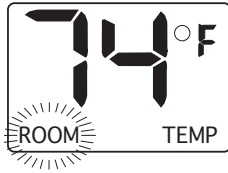

THERMO OFF

OPERATIONAL NOTES:

The Thermostat Feature on the transmitter operates the appliance whenever the ROOM TEMPERATURE varies a certain number of degrees from the SET TEMPERATURE. This variation is called the “SWING” or TEMPERATURE DIFFERENTIAL. The normal operating cycle of an appliance may be 2-4 times per hour depending on how well the room or home is insulated from the cold or drafts. The factory setting for the “swing number” is 2. This represents a temperature variation of +/- 2° F (1° C) between SET temperature and ROOM temperature, which determines when the fireplace will be activated.

The transmitter has ON and OFF manual functions that are activated by pressing either button on the face of the transmitter. When a button on the transmitter is pressed the word ON or OF will appear on the LCD screen to show while the signal is being sent. Upon initial use, there may be a delay of three seconds before the remote receiver will respond to the transmitter. This is part of the system's design.

REMOTE RECEIVER

IMPORTANT

THE REMOTE RECEIVER SHOULD BE POSITIONED WHERE AMBIENT TEMPERATURES DO NOT EXCEED 130° F.

The remote receiver (right) operates on four 1.5V AA-size batteries. It is recommended that ALKALINE batteries be used for longer battery life and maximum microprocessor performance. **IMPORTANT:** New or fully charged batteries are essential to proper operation of the remote receiver as a latching solenoid power consumption is substantially higher than standard remote control systems.

NOTE: The remote receiver will only respond to the transmitter when the 3-position slide button on the remote receiver is in the REMOTE position. The remote receiver houses the microprocessor that responds to commands from the transmitter to control system operation.

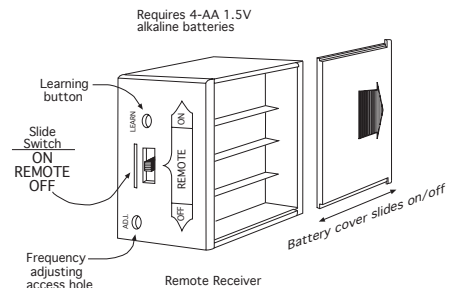

FUNCTIONS:

- With the slide switch in the ON position (toward the LEARN button), the system will remain on until the slide switch is placed in the OFF or REMOTE position.
- With the slide switch in the REMOTE position (centered), the system will only operate if the remote receiver receives commands **from the transmitter**.
- With the slide switch in the OFF position (away from the LEARN button), the system is off.
- **It is suggested that the slide switch be placed in the off position if you will be away from your home for an extended period of time. If the remote receiver is mounted out of children's reach, placing the slide switch in the OFF position also functions as a safety "lock-out" by both turning the system off and rendering the remote receiver inoperative.**

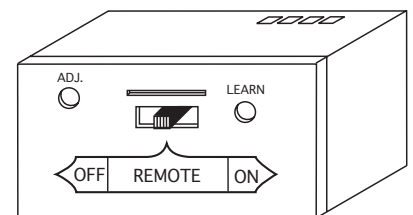

Part # BPR-3

NOTE: The RECEIVER comes from the factory programmed to provide pulse DC voltage (5.5 VDC to 6.3 VDC) to a latching solenoid.

INSTALLATION INSTRUCTIONS

WARNING

DO NOT CONNECT REMOTE RECEIVER DIRECTLY TO 110-120VAC POWER. THIS WILL BURN OUT THE RECEIVER. FOLLOW INSTRUCTIONS FROM MANUFACTURER OF GAS VALVE FOR CORRECT WIRING PROCEDURES. IMPROPER INSTALLATION OF ELECTRIC COMPONENTS CAN CAUSE DAMAGE TO GAS VALVE AND REMOTE RECEIVER. DAMAGE CAUSED BY IMPROPER INSTALLATION WILL NOT BE COVERED BY WARRANTY.

INSTALLATION

The remote receiver can be mounted on or near the fireplace hearth. PROTECTION FROM EXTREME HEAT IS VERY IMPORTANT. Like any piece of electronic equipment, the remote receiver should be kept away from temperatures exceeding 130° F inside the receiver case. Battery life is also significantly shortened if batteries are exposed to high temperatures.

NOTE: Installation of the receiver in the optional Ceramic Log House (Item# RH2)) is highly recommended.

HEARTH MOUNT

The remote receiver can be placed on the fireplace hearth or under the fireplace, behind the control access panel. Position where the ambient temperature inside the receiver case does not exceed 130° F.

NOTE: Black Button is used on Hearth Mount Applications.

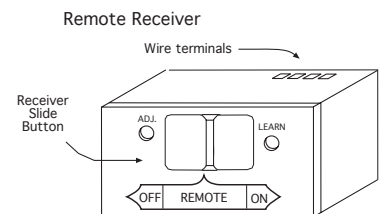

WIRING INSTRUCTIONS

Make sure the remote receiver switch is in the OFF position. For best results it is recommended that 18 gauge stranded wires should be used to make connections and should be no longer than 20 ft.

This THR-2R-1 remote receiver is to be connected to a manual valve with a latching ON/OFF solenoid.

Connect two 18 gauge stranded or solid wires from the remote receiver terminals to the latching solenoid. (See figure to the right)

IMPORTANT NOTE: Operation of this control is dependent on which wire is attached to which terminal. If operation of control does not correspond to operating buttons on transmitter, reverse wire installation at the receiver or at the control.

NOTE: Up to 6.3 VDC of power is provided at the receiver terminal.

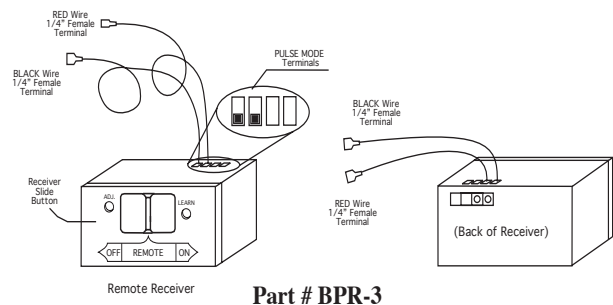
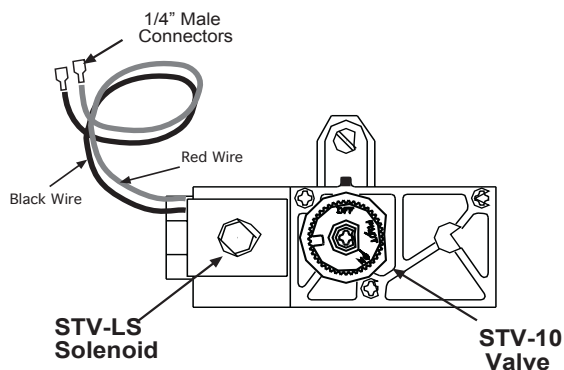

GENERAL INFORMATION

COMMUNICATION – SAFETY – TRANSMITTER

This remote control has a COMMUNICATION – SAFETY function built into its software. It provides an extra margin of safety when the TRANSMITTER is out of the normal 20 foot operating range of the receiver.

The COMMUNICATION – SAFETY feature operates in the following manner, in all OPERATING MODES – ON/ ON THERMOSTAT.

At all times and in all OPERATING MODES, the transmitter sends an RF signal every fifteen (15) minutes, to the receiver, indicating that the transmitter is within the normal operating range of 20 feet. Should the receiver NOT receive a transmitter signal every 15 minutes, the IC software, in the RECEIVER, will begin a 2-HOUR (120-minute) countdown timing function. If during this 2-hour period, the receiver does not receive a signal from the transmitter, the receiver will shut down the appliance being controlled by the receiver. The RECEIVER will then emit a series of rapid “beeps” for a period of 10 seconds. Then after 10 seconds of rapid beeping, the RECEIVER will continue to emit a single “beep” every 4 seconds until a transmitter ON or MODE Button is pressed to reset the receiver. The intermittent 4-second beeping will go on for as long as the receiver’s batteries last, which could be in excess of one year.

To “reset” the RECEIVER and operate the appliance, you must press the ON or MODE button on the transmitter. By turning the system to ON, the COMMUNICATION -SAFETY operation is overridden and the system will return to normal operation depending on the MODE selected at the transmitter. The COMMUNICATION – SAFETY feature will reactivate should the transmitter be taken out of the normal operating range or should the transmitter’s batteries fail or be removed.

CP (CHILDPROOF) FEATURE

This remote control includes a CHILDPROOF “LOCK-OUT” feature that allows the user to “LOCK-OUT” operation of the appliance, from the TRANSMITTER.

SETTING “LOCK-OUT” –(CP)

- To activate the “LOCK-OUT” feature, press and hold the ON button and the MODE button at the same time for 5 seconds. The letters CP will appear in the TEMP frame on the LCD screen.
- To disengage the “LOCK-OUT”, press and hold the ON button and the MODE button at the same time for 5 seconds and the letters CP will disappear from the LCD screen and the transmitter will return to its normal operating condition.
- To verify that transmitter is in the CP lock-out mode press any key and the LCD screen will show “CP”

NOTE: If the appliance is already operating in the ON or THERMO MODES, engaging the “LOCK-OUT” will not cancel the operating MODE. Engaging the “LOCK-OUT” prevents only the manual operation of the TRANSMITTER. If in the auto modes, the THERMO operation will continue to operate normally. To totally “LOCK-OUT” the operation of the TRANSMITTER’S operating signals, the transmitter’s MODE must be set to OFF.

MATCHING SECURITY CODES

Each transmitter can use one of 1,048,576 unique security codes. It may be necessary to program the remote receiver to LEARN the security code of the transmitter upon initial use, if batteries are replaced, or if a replacement transmitter is purchased from your dealer or the factory. When matching security codes, be sure slide button on the receiver is in the REMOTE position; the code will NOT “LEARN” if the slide switch is in the OFF position. Program the remote receiver to LEARN a new security code **Press and Release** the **LEARN** button on the top of the remote receiver and then **press** any button on the transmitter. A change in the beeping pattern, at the receiver, indicates the transmitter’s code has been programmed into the receiver. When an existing receiver is matched to a new transmitter, the new security code will overwrite the old one.

The microprocessor that controls the security code matching procedure is controlled by a timing function. If you are unsuccessful in matching the security code on the first attempt, wait 1 - 2 minutes before trying again--this delay allows the microprocessor to reset its timer circuitry--and try up to two or three more times.

TRANSMITTER WALL CLIP

The transmitter can be hung on a wall using the clip provided. If the clip is installed on a solid wood wall, drill 1/8" pilot holes and install with the screws provided. If it is installed on a plaster/wallboard wall, first drill two 1/4" holes into the wall. Then use a hammer to tap in the two plastic wall anchors flush with the wall; then install the screws provided.

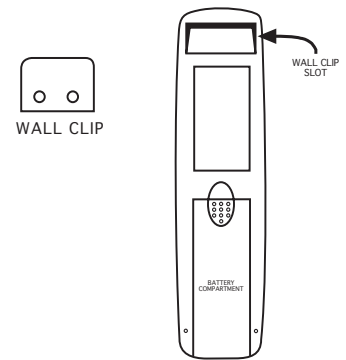

BATTERY LIFE

Life expectancy of the alkaline batteries in the THR-2R- can be up to 12 months depending on use of the solenoid function. Replace all batteries annually. When the transmitter no longer operates the remote receiver from a distance it did previously (i.e., the transmitter's range has decreased) or the remote receiver does not function at all, the batteries should be checked. It is important that the remote receiver batteries are fully charged, providing combined output voltage of at least 5.5volts. The transmitter should operate with as little as 2.5 volts battery power.

TROUBLE SHOOTING

If you encounter problems with your fireplace system, the problem may be with the fireplace itself or it could be with the THR-2R remote system. Review the fireplace manufacturer's operation manual to make sure all connections are properly made. Then check the operation of the remote in the following manner:

- Make sure the batteries are correctly installed in the RECEIVER. One reversed battery will keep receiver from operating properly.
- Check battery in TRANSMITTER to make sure contacts are touching (+) and (-) ends of battery. Bend metal contacts in for tighter fit.
- Be sure RECEIVER and TRANSMITTER are within 20'-25' operating range.
- Keep RECEIVER from temperatures exceeding 130° F. Battery life shortened when ambient temperatures are above 115° F.
- If RECEIVER is installed in tightly enclosed metal surround, the operating distance will be shortened.

NOTE.

- Due to handling and shipping of the unit, handling or dropping of the transmitter by the customer, and/or heat conditions at the receiver, some receivers may need an occasional frequency adjustment. This adjustment is made to improve the communication and operating distance between the transmitter and the receiver. Follow the steps below for making the adjustment.

FREQUENCY (DISTANCE) ADJUSTMENT PROCEDURE

RECEIVER ADJUSTMENT

1. To adjust at the receiver, use a small slotted screwdriver. Turn the adjustment (ADJ) screw counter-clockwise about 5° or maximum of 1/8 turn. This should correct the distance problem.
2. If that does not correct the problem, return adjustment screw to original position and then turn adjustment screw clockwise.

This adjustment is like tuning your radio. If you keep turning the adjustment screw, in either direction, you will go past the proper setting (tuning).

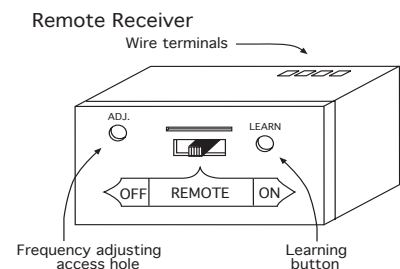

SPECIFICATIONS

BATTERIES: Transmitter (2) 1.5 volt AAA t bateries
Remote Receiver 6V - 4 ea. AA 1.5 Alkaline

Operating Frequency: 303.8 MHZ

FCC ID No.'s: transmitter - K9LSP1001TH;
Canadian IC ID No.'s: transmitter – 2439A-SP1001TH;

FCC REQUIREMENTS

NOTE: THE MANUFACTURER IS NOT RESPONSIBLE FOR ANY RADIO OR TV INTERFERENCE CAUSED BY UNAUTHORIZED MODIFICATIONS TO THIS EQUIPMENT. SUCH MODIFICATIONS COULD VOID THE USER'S AUTHORITY TO OPERATE THE EQUIPMENT.

