



EIS-RS/L150
0512

RASMUSSEN IRON WORKS, INC.
12028 E. Philadelphia St. Whittier, CA 90601 U.S.A.
(562) 696-8718 FAX: (562) 698-3510
info@rasmussen.biz www.rasmussen.biz

EIS-RS150 and EIS-RL150 **Installation and Operation Instructions**

Read these instructions and the instructions for the burner kit this unit is to be used with carefully before starting installation of this product. The consumer should retain these instructions for future reference.

WARNING: Improper installation, adjustment, alteration, service and/or maintenance can cause property damage, personal injury or loss of life. Read these instructions thoroughly before installation. For assistance or additional information, consult your gas log dealer, qualified installer, service agency, gas supplier or the manufacturer.

WARNING: Installation and service must be performed by a qualified installer.

WARNING: This product is only for use with Vented Gas Log Systems installed in a fully functioning solid-fuel burning fireplace which is constructed of non-combustible material with a working flue.

WARNING: When operating, the damper must be wide open. The flue must vent all of the products of combustion.

CAUTION: Glass Doors must be opened during use for proper venting, combustion, and cooling of components.

WARNING:

1. Disconnect power before wiring to prevent electrical shock or equipment damage.
2. To avoid dangerous accumulation of fuel gas, turn off gas supply at the appliance service valve before starting installation, and perform a Gas Leak Test after installation is complete.
3. Always install a sediment trap in the gas supply line to prevent contamination of the gas control.
4. Do not force the gas control knob. Use only your hand to turn the gas control knob—never use any tools. If the gas control knob does not operate by hand, the gas control valve should be replaced by a qualified service technician. Force or any attempt to repair the gas control valve can result in fire or explosion.

The minimum inlet gas supply pressure for the purpose of input adjustment shall be 6 inches of water column on natural gas and 11 inches of water column on propane.

The maximum inlet gas supply pressure shall be 7 inches of water column on natural gas and 14 inches of water column on propane.

This control valve must be disconnected and/or isolated from the gas supply piping system during any pressure testing at test pressures greater than 1/2 psig (3.5 kPa).

WARNING: Do not use this control system if any part has been under water. Replace any part of this control system which has been under water.

PLEASE NOTE: These EIS kits are provided from the factory ready for use with Natural Gas. Please see Page 8 for instructions on converting the control valve and pilot for use with Propane.

Kit Components

Figure 1—EIS-RS150 Powered by batteries (4-AA). A/C optional. Install within 18-inches of the burner.

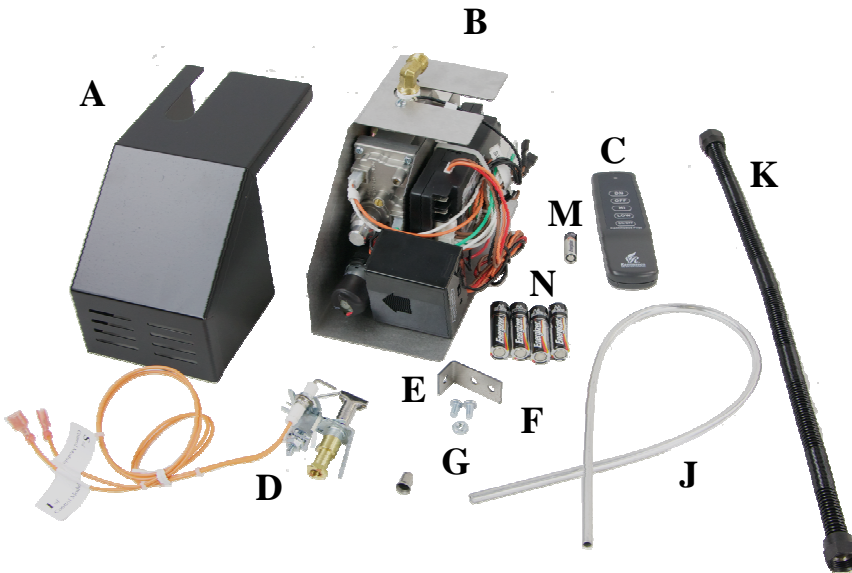

EIS-RS150

- A = Heat Shield
- B = Control Valve/Module Assembly
 - Control Valve
 - Control Module
 - Battery Pack
 - Motor Drive
- C = Wireless Hand-held Transmitter
- D = Pilot/Igniter Assembly
 - Pilot Assembly with fittings
 - 2—Igniters with 24” leads
- E = Pilot Mounting Bracket
- F = 2—10-32 x 3/8” bolts
- G = 10-32 Hex Nut
- J = 2’ x 1/4” aluminum pilot tubing
- K = 18” x 3/8” SS Flex Connector Tube
- L = 4—AA batteries
- M = 1—A23 12V battery

Figure 2—EIS-RL150 Powered by 120V AC adapter with battery back-up (4-AA). Install within 5-feet of the burner.

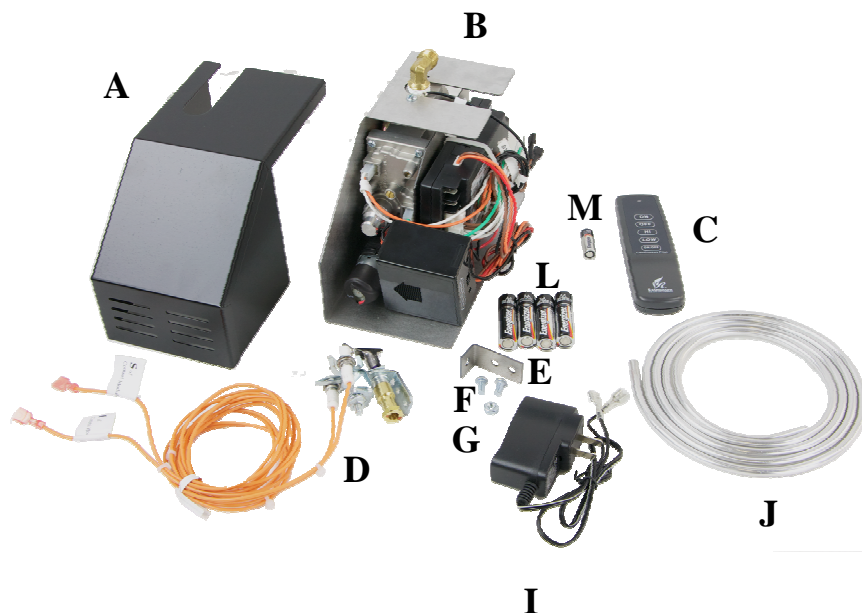

EIS-RL150

- A = Heat Shield
- B = Control Valve/Module Assembly
 - Control Valve
 - Control Module
 - Battery Pack
 - Motor Drive
- C = Wireless Hand-held Transmitter
- D = Pilot/Igniter Assembly
 - Pilot Assembly with fittings
 - 2—Igniters with 72” leads
- E = Pilot Mounting Bracket
- F = 2—10-32 x 3/8” bolts
- G = 10-32 Hex Nut
- I = 6V DC/120V A/C Power Adapter
- J = 6’ x 1/4” aluminum pilot tubing
- L = 4—AA batteries
- M = 1—A23 12V battery

Please familiarize yourself with the Control Valve/Module Assembly

Figure 3—Back of Control Assembly

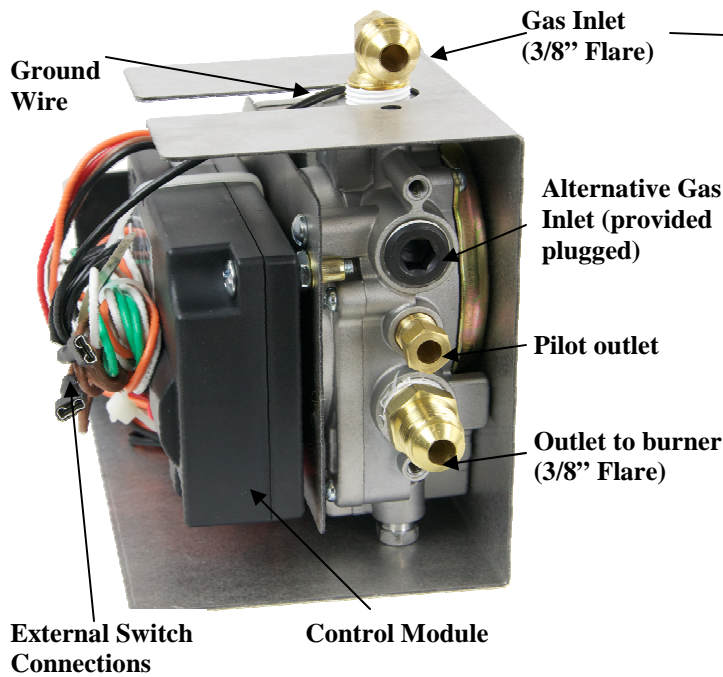

Figure 4—Front of Control Assembly

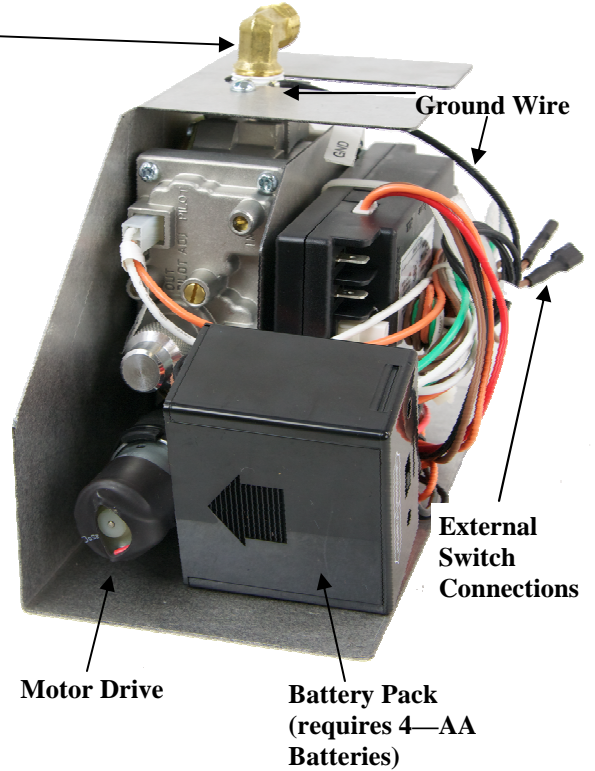

Figure 5—Right Side of Control Assembly
(There are no use accessible parts on the left side)

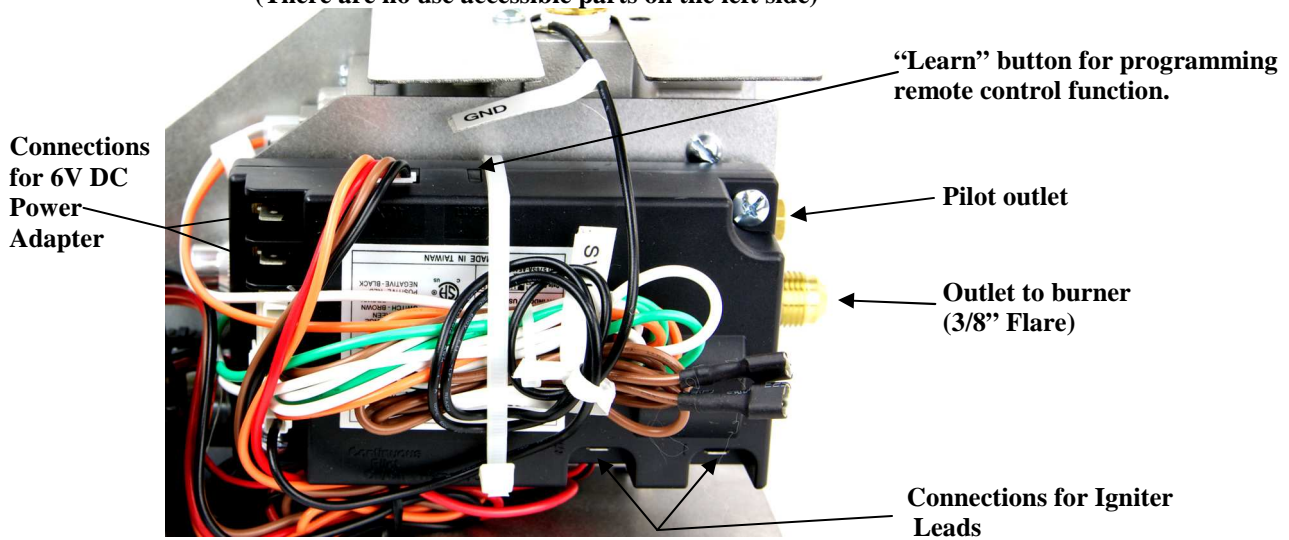

Figure 6
Wireless Hand-held Transmitter

Sensor—In pilot flame path to tell control module of the presence of the pilot flame. Connect to “S” at control module.

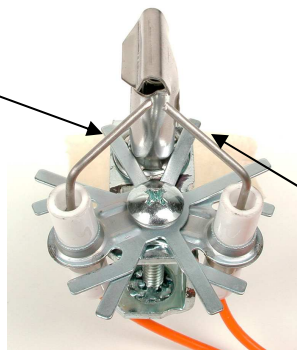

Figure 7
Pilot/Igniter Assembly

Igniter—Sparks to light pilot. Connect to “I” at control module.

Required Tools and Materials: Adjustable Wrench, Pipe Wrench, Slot Screwdriver, Pipe thread sealing compound or Teflon tape, Matches.

Location: Locate the gas control valve assembly where it cannot be affected by steam cleaning, high humidity, dripping water, corrosive chemicals, dust or grease accumulation, or excessive heat. To promote proper operation, please follow these guidelines:

1. Locate gas control in a well-ventilated area. If installing in the firebox, this would be the front right corner in the path of cooling air from the room.. Never place the gas control behind the gas log set.
2. Mount gas control high enough to avoid exposure to flooding or splashing water.
3. Ensure the ambient temperature does not exceed the ambient temperature rating of each component (0°F to 175°F (-18°C to 79°C)).
4. Cover gas control if the appliance is cleaned with water, steam, chemicals or to avoid dust and grease accumulation.
5. Avoid locating gas control where exposure to corrosive chemical fumes or dripping water is likely.

Please Note:

- EIS-RS150 is intended for installation in the right side of the firebox (all shielding and bracketing is based on right side installation). If gas supply is on the left side of the fireplace, plumb around the back of the gas log set to provide gas supply to the EIS control valve.
- EIS-RSL150 is intended for installation outside of the firebox in a vault which is supplied with gas and 120V electricity. Provisions must be made from the vault to the firebox for gas and a non-metallic conduit for the igniter wires and pilot tubing.

Install Piping to Gas Control: All piping must conform with local codes and/or the National Fuel Gas Code (ANSI Z223.1/ NFPA54).

1. Use new, properly reamed pipe which is free from chip. When using tubing, assure the ends are square, deburred and clean. All tubing bends must be smooth and without deformation.
2. Run pipe or tubing to the inlet of the control. The control comes standard with a 3/8" flare fitting installed. Remove as needed if connecting directly to pipe or another tubing size.
3. Install a sediment trap in the supply line to the gas control. See Figure 3

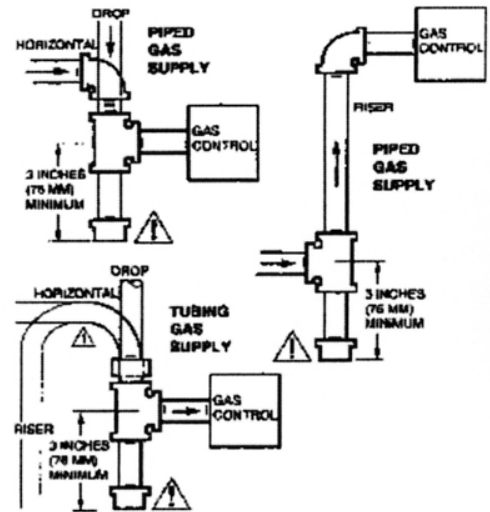

Figure 8

WARNING: Pipe thread sealing compound or Teflon tape must be used on pipe threads. DO NOT use pipe thread sealing compound or Teflon tape on flared connections, as this may cause a gas leak.

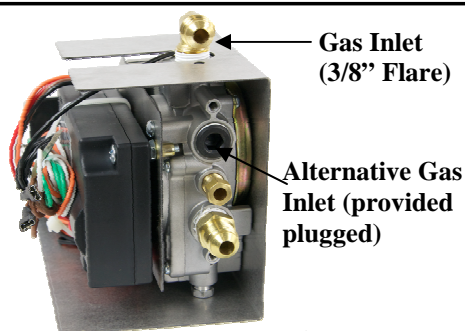
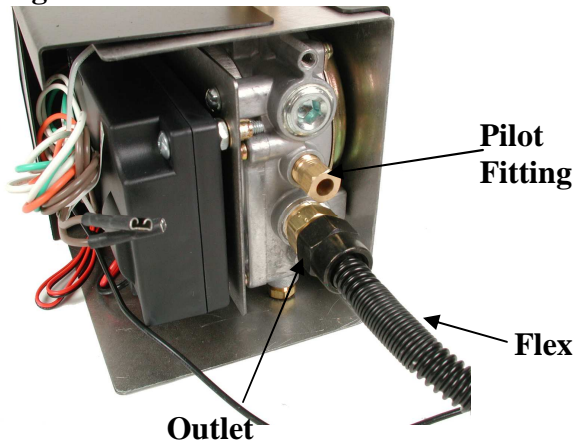

Figure 9

4. Attached the gas supply to the Gas Inlet. Do not use pipe thread compound on the flared fitting.
 - The alternative Gas Inlet may be used, if desired. Be sure to plug the top Gas Inlet if you do.

Figure 10



Connect Gas Supply to Outlet:

- 1) Connect flex tube or other suitable piping to outlet of control valve.
- 2) Connect other end of tube to gas log burner inlet. Refer to instructions supplied with gas log burner.
 - A) Natural gas sets do not use an air mixer. White sand is the pan filler.
 - B) Propane use requires air mixer at burner inlet. Black volcanic ash is the pan filler.

Determine Pilot Bracket Needed Based on Burner Type, then attach bracket to pilot assembly (if needed) using 10-32x3/8" bolt to threads of pilot bracket

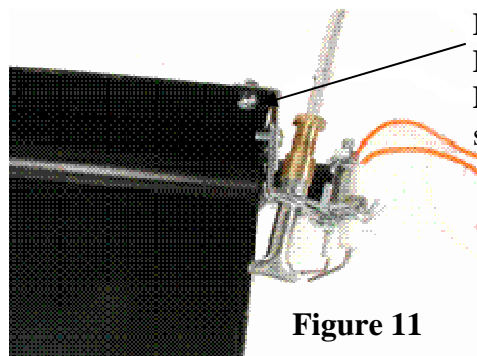

Figure 11

**F,FA,FX,FAX
Flaming Ember
Burner—Bracket as
shown.**

**CS,CA Custom Pan
Burner—Bracket as
shown.**

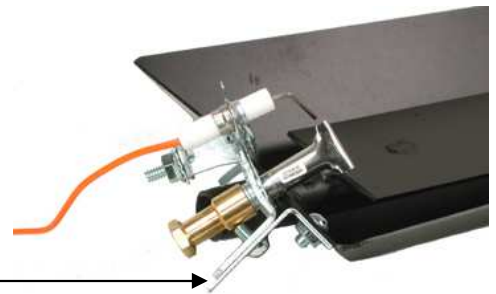

Figure 12

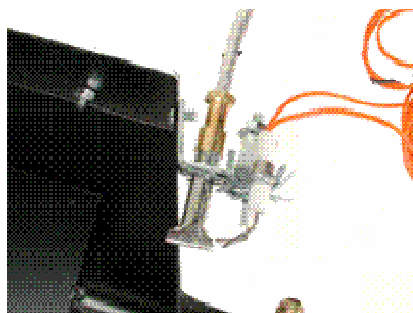

Figure 13

**CXF, CXFA Custom Embers
Pan Burner (Figure 13) and
TNA Tipi/Andiron Burner
(Figure 14) - No bracket needed.
Attach directly to burner as
shown.**

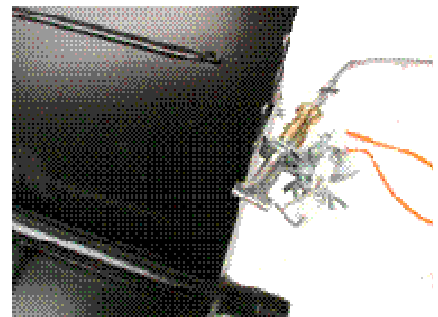

Figure 14

Connect Pilot Tubing to Valve:

Note: It may be necessary to cut the pilot tubing to fit the distance between the control valve and pilot location at the burner. Measure twice, cut once. Use a tubing cutter and debur before assembling.

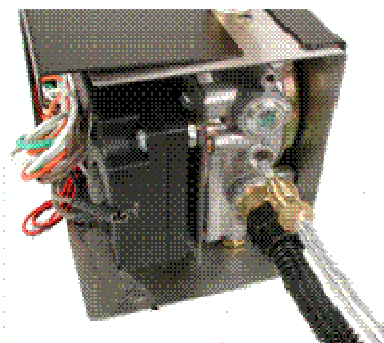

Figure 15
Insert Pilot
tubing through
Pilot fitting

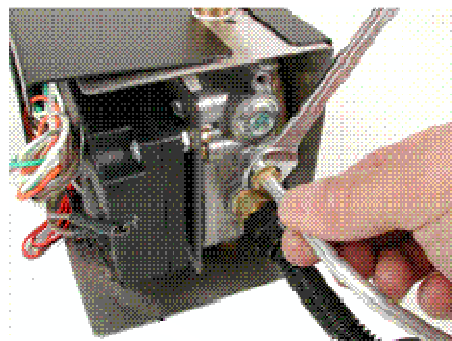
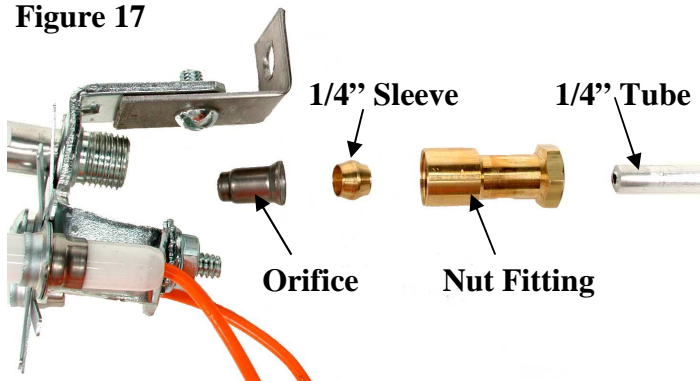

Figure 16
Tighten Pilot
fitting with
7/16" end
wrench or
adjustable
wrench. Push in
on tubing while
tightening.

Connect Pilot Tubing to Pilot Assembly:**Figure 17**

1) Insert 1/4" tube through Nut Fitting and 1/4" Sleeve (Figure 18)

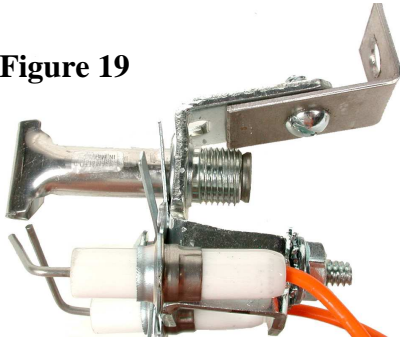

2) Insert Orifice into Pilot Assembly (Figure 19).
Note: Use LP Orifice is control to be used with Propane.

Figure 19

3) Insert Tube, Nut and Sleeve as shown in Figure 20 into orifice installed in pilot Assembly.

Figure 20

Figure 21: Tighten Pilot fitting with 1/2" end wrench or adjustable wrench. Push in on tubing while tightening.

Figure 21

Attach Pilot Burner Assembly to Burner per Figures 11-14, as appropriate.

Connect Igniter and Sensor Leads to Control Module

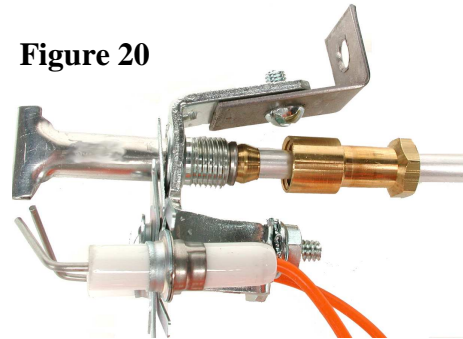
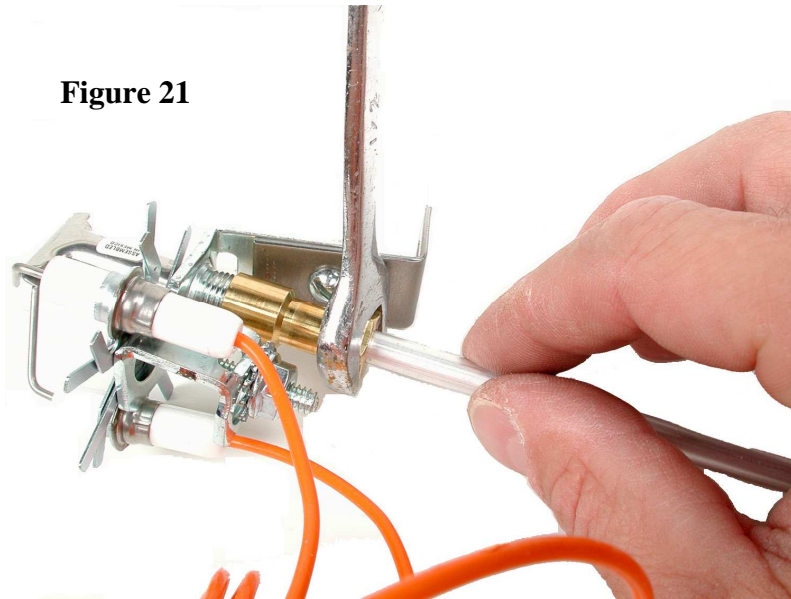
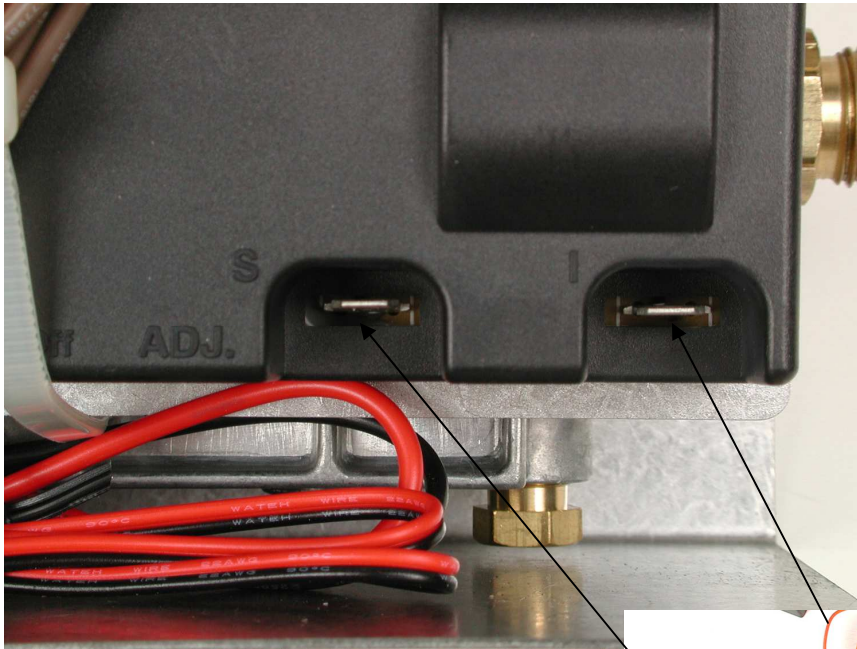

Figure 22

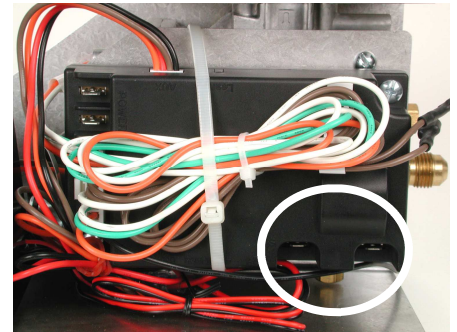

Figure 22A

- **Connect Orange Sensor “S” wire to the “S” of Control Module**
- **Connect Orange Igniter “I” wire to the “I” of Control Module**



Figure 23

Connect 6 Volt DC Power Adapter to Control Module

Standard on EIS-RL150, optional on EIS-RS150. When using the Power Adaptor, the battery pack functions as a back up in case of an electrical power outage.

Figure 24A



Figure 24

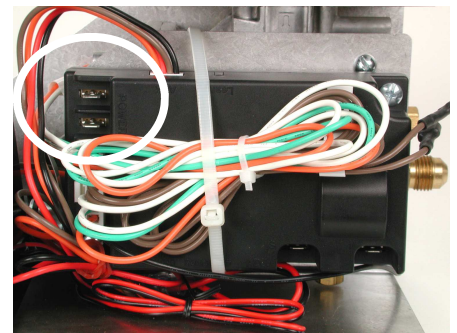

- **Connect 6V DC Power Adapter to “POWER” connections at Control Module.**



Figure 25

Connect 6 Volt DC Power Adapter to 120V AC power plug (“house current”)

Install 4—AA Alkaline Batteries into the Battery Pack



Figure 26

The door of the Battery Pack slides open in the direction of the Arrow.

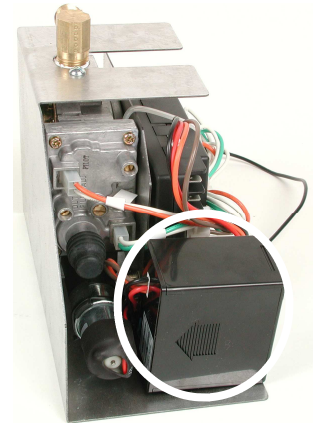

Figure 26A

Converting for Propane Use

The Control Valve is convertible from Natural Gas to Propane by a Simple Rotary Knob located on the front face of the valve (Figure 27)

- 1) Install the Propane Orifice in the Pilot Assembly as detailed in Figure 19, Page 6.
- 2) Remove the Black Cap by pulling the cap straight off. Note the position of the marker on the shaft of the Simple Rotary Knob. This mark will point to NAT or LP (propane) to indicate the gas type setting.
- 3) To convert the Control Valve from the factory setting (NAT), push in the Simple Rotary Knob and rotate 90-degrees. Note: the marker will now point to LP and the shaft will stay in.
- 4) To convert the Control Valve back to the factory setting (NAT), push in the Simple Rotary Knob and rotate 90-degrees. Note: the marker will point to NAT and the shaft will stay out.

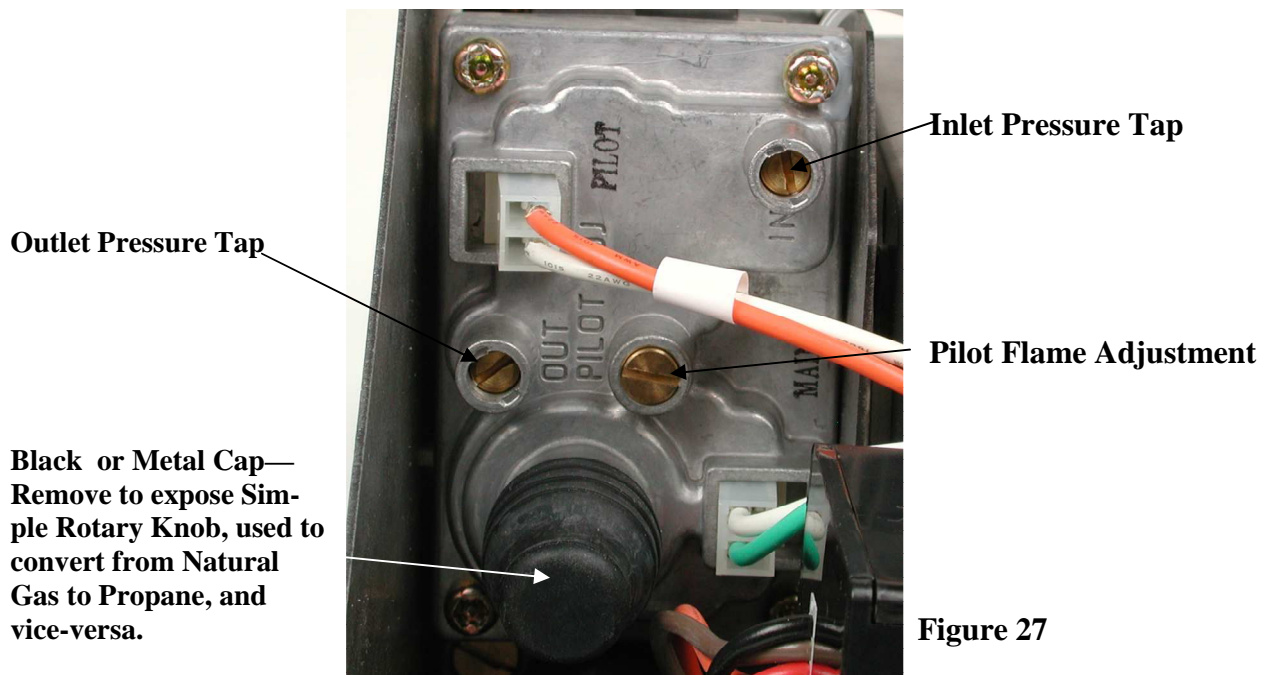

Figure 27

- 5) After the conversion has been made, check the Outlet Pressure with a manometer. The factory setting for the internal pressure regulator is 3.5" wc for Natural Gas, 10.5" wc for Propane.
- 6) Replace the Black Cap.

Connect the Ground Wire

Note: Good Ground must be established and maintained for this system to function properly. Most operation issues are the result of incomplete Ground.

- 1) The Ground Wire is factory assembled at the top of the valve and chassis (Figure 28)

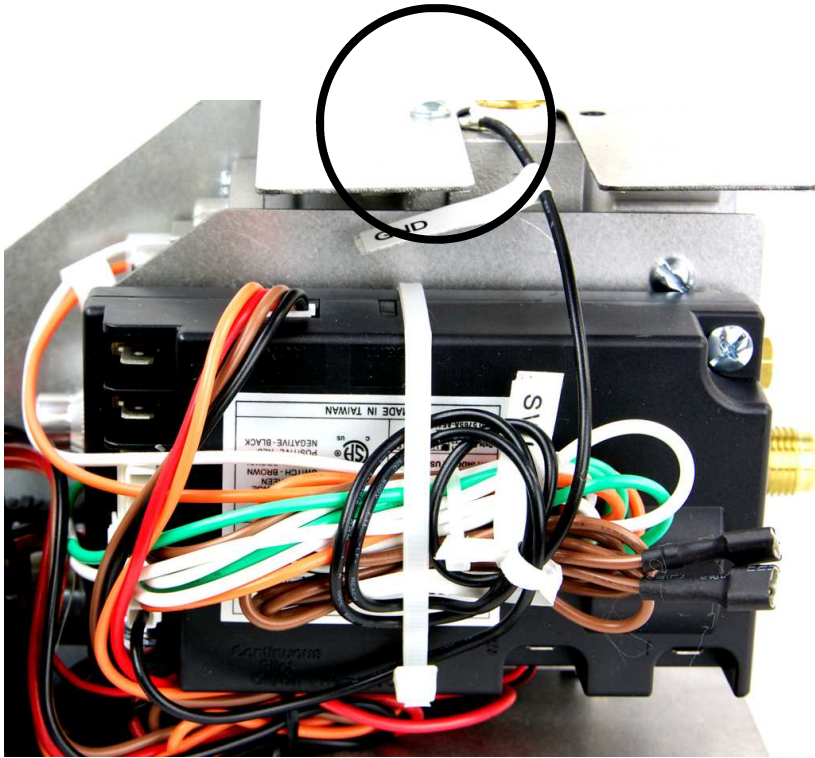

Figure 28

Continuous Pilot Feature—This allows the user to change from a spark-to-pilot system to a standing pilot system to avoid the lighting (sparking) sequence each time the user wishes to enjoy their gas log set.

- 1) Locate the Continuous Pilot Switch on the underside of the Control Module (Figure 29).
- 2) When this switch is in the OFF position and the gas log set is switched ON, the pilot will spark and light. When the gas log set is switched OFF, the pilot will switch OFF when the main burner shuts OFF.
- 3) When this switch is in the ON position and the gas log set is switched ON, the pilot will spark and light. When the gas log set is switched OFF, the pilot will remain ON when the main burner shuts OFF. This setting is generally used in Cold Climates to keep the firebox warm, or to avoid the sparking sequence.
- 4) The Continuous pilot mode can also be activated by the wireless hand-held Remote Control.



Continuous Pilot Switch

Remote Enable Switch

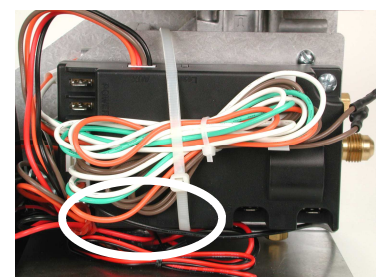

Figure 29A

Figure 29

Remote Control Feature—The Control Module has a built-in remote control receiver which allows the user to program a hand-held remote transmitter at any time during or after the installation of the gas log set.

- 1) Locate the Remote Switch on the underside of the Control Module (Figure 29).
- 2) This switch must be in the REMOTE position for the remote control feature to operate.
- 3) The switch in the Battery Pack (Figure 30) must be in the “DC Motor Drive” position for proper operation.



Figure 30

Remote Control Transmitter—Programming

- 1) Install one—12V (A23) alkaline battery in the hand-held Transmitter.
- 2) Press and release the “LEARN” button on the top of the Control Module (Figure 31), which will then make a beep sound. After this, press any button on the hand-held Transmitter. Once the Control Module’s internal receiver accepts the transmitter code there will be a series of confirming beeps.

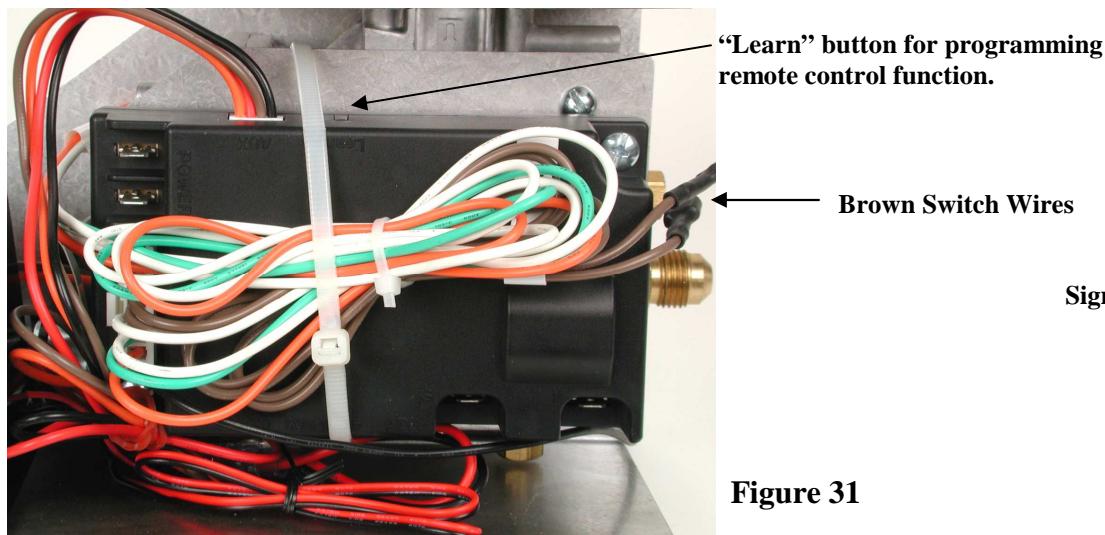

Figure 31

About the Remote Control Transmitter—

- 1) This Transmitter has an operating range of about 20 feet. The transmitter operates on one of 65,536 security codes that are programmed into the transmitter at the factory. It operates on radio frequencies with non-directional signals.
- 2) The Transmitter has ON/OFF, HI/LO and CONTINUOUS PILOT functions that are activated by pressing any button on the face of the transmitter.
- 3) When a button is pressed, a signal light on the Transmitter illuminates briefly to confirm that a signal has been sent.
- 4) Upon initial use, there may be a delay of three seconds before the remote receiver will respond to the transmitter. This is part of the system’s design.
- 5) If the signal light does not illuminate, check the position or strength of the trans-

Signal Light



Figure 32

Use this EIS Kit with “Smart House” type systems

- 1) Ignite system with remote control and adjust flame to desired height.
- 2) Connect SmartHouse system to the two Brown Switch Wires (Figure 31).
- 3) Slide Remote Enable Switch (Figure 29) to OFF. This disables the Remote functions.
- 4) SmartHouse system will only be able to turn the unit ON and OFF. Any flame adjustment will need to be accomplished by the Remote Transmitter with the Remote Enable Switch to ON.

Install the Heat Shield—Place the Heat Shield over the Control Valve/Module Assembly.

CAUTION: The HEAT SHIELD must be in place with the double wall side facing the gas log burner. Operating the Gas Log Burner without the heat shield installed may result in unwarrantable heat damage to the valve, module and/or components.

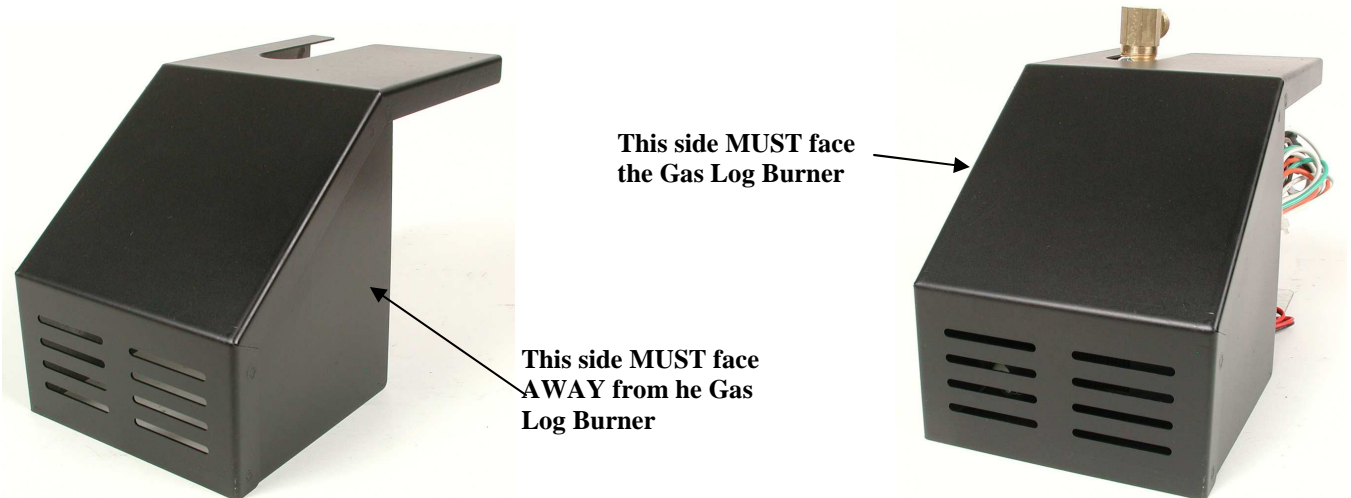

Figure 33—Heat Shield

Figure 34—Heat Shield Installed

CAUTION! DAMPER AND GLASS DOORS MUST BE FULLY OPEN BEFORE LIGHTING OR BURNING FOR PROPER VENTILATION AND TO PREVENT HEAT DAMAGE TO VALVE

Lighting the Gas Log Burner with the Remote Control Transmitter

- 1) Press the ON button. This starts the Igniter (Page 3, Figure 7) sparking and opens the flow of gas to the pilot. It may take up to a couple of minutes for the gas to displace air in the pilot line before the gas lights from the Igniter's sparking.
- 2) The Sensor (Page 3, Figure 7) must be in the path of the pilot flame to "prove" the existence of the pilot flame to the control module.
- 3) Once the Sensor proves the pilot flame, gas will flow to the gas log burner.
- 4) You may adjust the flame height of the gas log burner with the HI and LOW buttons.

Turning OFF the Gas Log Burner with the Remote Control Transmitter

- 1) Press OFF. This shuts off the flow of gas to the gas log burner and the pilot.

Continuous Pilot Feature—This feature allows the user to keep the pilot flame burning constantly. This can speed up gas log burner lighting during the heating season.

- 1) Press and release the CONTINUOUS PILOT button to turn this feature ON or OFF. The CONTINUOUS PILOT switch on the Control Module (Page 9, Figure 29) can also be used to enable this feature.

Battery Life—The batteries should last a season. Replace Transmitter and Battery Pack batteries annually.



Figure 35

Troubleshooting

If the pilot will not stay lit:

- 1) Confirm that the “S” wire and the “T” wire are properly connected to the Control Module at the “S” and “T” Terminals. See Page 7 Figure 22 for terminal locations.
- 2) Confirm that the Pilot/Igniter Assembly is properly grounded with the Ground wire from the Control Module. You may need to scratch away paint from the burner to make good ground contact.
- 3) Check the power sources:
 - A) Ensure the 6 volt Power Adapter wires are properly connected to the POWER terminals at the Control Module and that the Power Adapter is plugged into a live 120V AC receptacle.
 - B) Ensure that the batteries in the Battery Pack are providing power and that the wire connections are intact.
- 4) The CONTINUOUS PILOT switch on the Control Module should be OFF. See Page 9 Figure 29.

If the gas log burner does not come ON when the remote control is turned to ON:

- 1) Confirm that pilot sparks and lights. Allow sufficient time for air in the line to be displaced by gas.
- 2) Ensure that the SENSOR electrode (Page 3 Figure 7) is in the pilot flame. Be careful when adjusting electrode not to break white ceramic. It is best to hold the portion of the electrode closest to the ceramic with needle-nose pliers (to isolate force on the electrode from the ceramic) then bend the tip of the electrode as needed.
- 3) Check to ensure the Orange/White wires two-pin plastic connector is inserted into the “PILOT” connection point on the face of the Control Valve.
- 4) Check to ensure the Green/White wires two-pin plastic connector is inserted into the “MAIN” connection point on the face of the Control Valve.

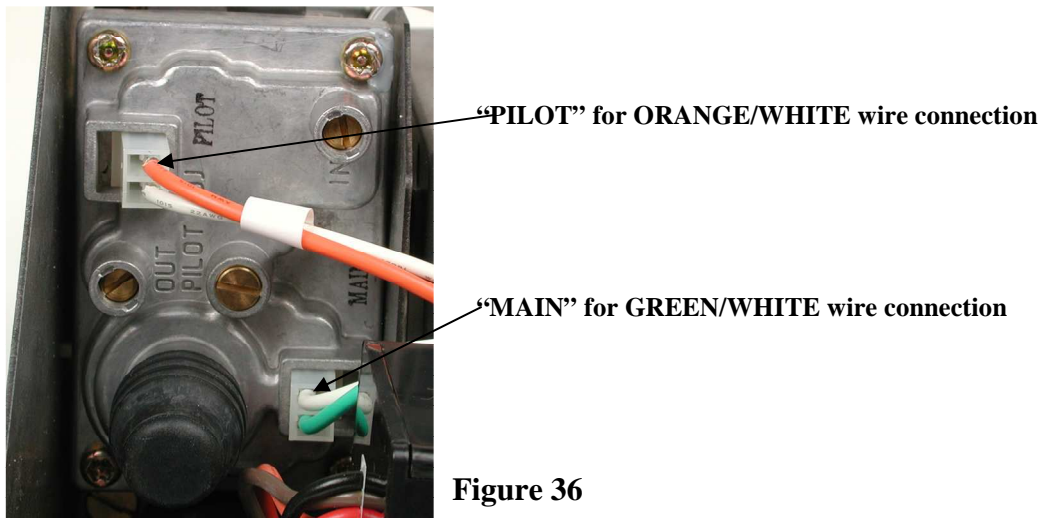

Figure 36

Limited Warranty

Rasmussen warrants this system for 12 months from date of purchase to the original purchaser to be free from defects in materials and workmanship. Damage to the system caused by accident, misuse, abuse or installation error, whether performed by a dealer, contractor, service company or owner is not covered by this warranty. Rasmussen is not responsible for labor or shipping charges and/or damage incurred in the installation, repair, replacement or for incidental or consequential damages. Rasmussen's maximum liability shall not exceed the price paid to Rasmussen for this product. Some states, provinces and nations do not allow exclusion or limitations of incidental or consequential damages, so the above limitations or exclusions may not apply. This warranty gives you specific legal rights. You may also have other rights that vary by state, province or nation. Rasmussen makes no warranties, expressed or implied, other than those expressly stated herein.