

User guide.

TCL LINKZONE 

Table of Contents

Table of Contents	2
Read this first	3
Chapter 1. Meeting TCL LINKZONE 5G UW	4
1.1 System requirements.....	4
1.2 Overview.....	4
1.3 Status Icons	6
Chapter 2. Getting Started	7
2.1 Insert a nano SIM card.....	7
2.2 Unlock the SIM card.....	7
2.3 Insert the Battery	8
2.4 Charge the TCL LINKZONE 5G UW.....	8
Chapter 3. Using TCL LINKZONE 5G UW	9
3.1 Turn your LINKZONE on or off	9
3.2 Connect to LINKZONE network.....	9
Chapter 4. Accessing the Touchscreen	11
4.1 Homescreen.....	11
4.2 Wi-Fi	11
4.3 Data Usage	12
4.4 Connected Devices	12
4.5 Messages	13
4.6 Settings	13
4.7 Universal Charging	14
4.8 Software Update	14
4.9 About	14
4.9 Help.....	15
Chapter 5. Accessing the Admin Web UI	16
5.1 Log in to the Admin Web UI	16
5.2 Explore Admin web UI features.....	16
Chapter 6. Configuring Your LINKZONE via the Admin Web UI	17
6.1 Home	17
6.2 Wi-Fi.....	18
6.3 Data Usage.....	20
6.4 Connected Devices.....	20
6.5 Messages.....	20
6.6 Mobile Network	21
6.7 Parental Controls.....	22
6.8 Settings.....	23
6.9 Software Update.....	25
6.10 About	25
6.11 Help	25
Chapter 7. Configuring your LINKZONE using the TCL Connect app	26
7.1 Download the TCL Connect app.....	26
7.2 Pair your phone or tablet with the LINKZONE	26
7.3 Use the TCL Connect app	26
7.4 Unbind	30
Chapter 8. Troubleshooting	31
Appendix A. Important safety information	33

Read this first

- Before using this documentation and the device it supports, ensure you read and understand the "Appendix A. Important safety information" on page 33.
- Illustrations in this documentation might look different from your device.
- Instructions in this documentation may vary depending on your device model and software version.
- Some apps and features are not available in all countries or regions. App and feature availability is subject to change.
- Documentation content is subject to change without notice. We make constant improvements on the documentation of your device, including this user manual.
- TCL Communication Ltd. does not assume any liability that may occur due to the use or application of the product described herein. Every effort has been made in the preparation of this documentation to ensure accuracy of the contents, but all statements, information and recommendations in this documentation do not constitute the warranty of any kind, express or implied.

Chapter 1. Meeting TCL LINKZONE 5G UW

As a 5G mobile hotspot, the LINKZONE 5G UW enables up to 32 Wi-Fi connections at both 2.4 GHz and 5 GHz. With various features and functions, it is a perfect hub for your home or business network.

1.1 System requirements

Your LINKZONE is compatible with most browsers, including Firefox, Safari, Internet Explorer (11.0 or later), Microsoft Edge, Opera, and Google Chrome.

1.2 Overview



1. Touch screen

Navigate the screen using your finger.

2. Power button

- To turn on, press and hold until screen welcome message appears.
- To turn off, press and hold until Shutdown screen appears. Then tap 'shutdown'.
- Press and release to wake up the display.

3. USB-C port

- Connect to a power supply using the included Type-C cable and wall adapter.
- Connect to "On the Go" (OTG) Cable (sold separately) to recharge other accessories such as a smartphone or bluetooth headset.
- Connect to a computer using the included Type-C cable which provides secure connection.

4. LAN port

Connect an Ethernet cable to a computer which provides secure connection to connected devices.

5. Reset button















If your device does not respond or needs to be reset, insert a sharp object, such as a paper clip into this hole for 3 seconds.

NOTE: All passwords will be reset to default settings.

Status LED

LED Status	Description
Blinking Green (500 ms)	Attached to home network but not connected
Blinking Green (250 ms)	Attached to home network and connected with data activity
Solid Green	Attached to home network and connected with no data activity
Solid Blue	Attached to roaming network and connected with no data activity
Blinking Blue (500 ms)	Attached to roaming network but not connected
Blinking Blue (250 ms)	Attached to roaming network and connected with data activity
Solid White	PIN lock or UICC error
Blinking White	Software update
Blinking Red	Device is powering up
Solid Red	SIM card is not activated or no data balance
No LED	<ul style="list-style-type: none">• System sleep mode• The screen is lit up

1.3 Status Icons

	Home
	Network signal strength
	LAN connection
	USB connection
	LINKZONE Wi-Fi network
	Connected devices
	Wi-Fi name/password
	No network service
	SIM card not available
	SIM card locked
	Unread messages
	The battery is fully charged.
	The battery is running low.
	The battery is charging.

Chapter 2. Getting Started

This chapter introduces the basic instructions on how to set up your LINKZONE and make connections.

2.1 Insert a nano SIM card

Your device has a Verizon 5G SIM card already installed.

If the SIM card must be replaced:

1. Open the back cover, remove the battery, and slide the SIM card out of the SIM Card Slot.
2. To reinstall it, align the cutout tab using the diagram and gently slide the card into the slot with gold metal side down.
3. Reinstall the battery.
4. Close the back cover.

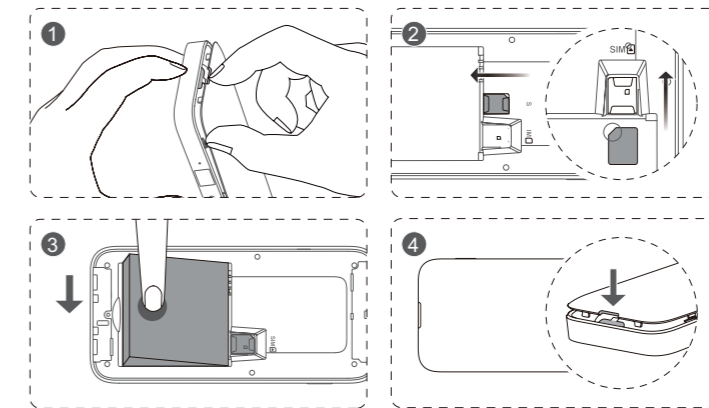

NOTE:

- Do not bend or scratch your SIM card.
- Avoid exposing your SIM card to static electricity, water, or dirt.

2.2 Unlock the SIM card

If your SIM card is locked, click "Unlock the SIM card" to jump to SIM PIN Management page (or navigate to **Mobile Network** > **SIM PIN Management** from the side bar.) and enter the SIM PIN to unlock the SIM card.

NOTE: Only 3 attempts are allowed, or you have to contact Verizon for a Personal Unblocking Key (PUK). If you input the SIM PUK incorrectly for 10 consecutive times, the SIM card will be permanently locked. Contact the carrier to replace the SIM card.

2.3 Insert the Battery

To install the battery:

1. Align the metal contacts with the pins inside the battery compartment.
2. Press the battery down until it properly sits in place.
3. Press the back cover into place by aligning the tabs. It only fits one way.

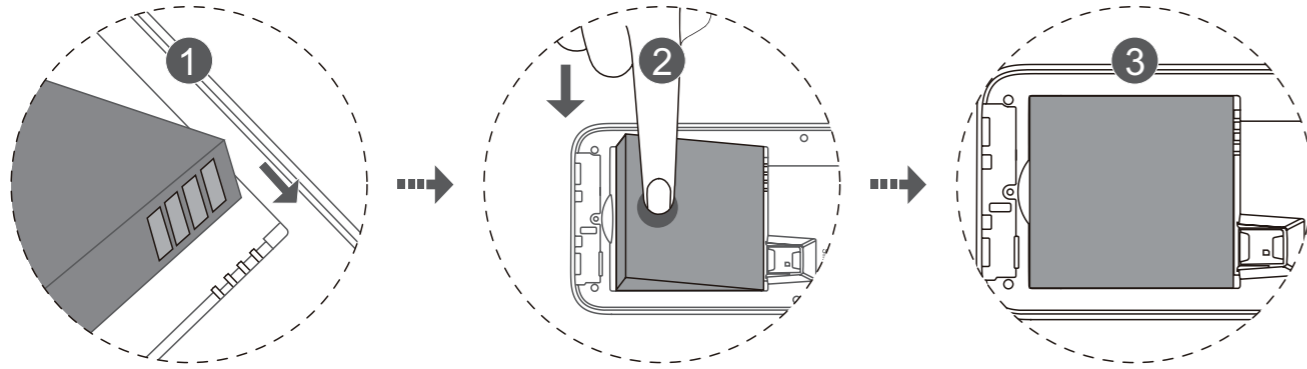

NOTE:

Whenever you remove or insert the battery, ensure your LINKZONE is not connected to any device or power source.

2.4 Charge the TCL LINKZONE 5G UW

Before setting up your LINKZONE, make sure LINKZONE is charged for at least 2 hours.

To charge the LINKZONE:

1. Connect one end of a Type-C cable to the device and the other end to a wall charger.
2. Insert the wall charger into AC power source.

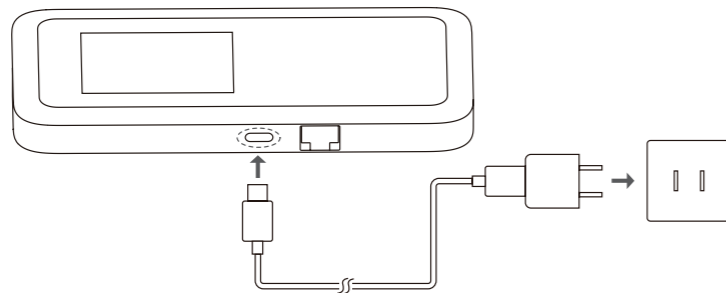

Chapter 3. Using TCL LINKZONE 5G UW

3.1 Turn your LINKZONE on or off

To turn your LINKZONE on or off:

1. Press and hold the power button to turn on your LINKZONE. When the display screen lights up, remove your finger from the button.
2. Following the wakeup animation, select English or Spanish language, and then tap on the Home screen icons to familiarize yourself with the menu and features of your LINKZONE.
3. A single press of the power button will turn on the display screen and wake up the device.
4. To turn LINKZONE off, press and hold the power button. Then tap "Shutdown" on the touchscreen to power down the device, or tap "Restart" to power cycle your device.

3.2 Connect to LINKZONE network

You have two options to connect your LINKZONE to the network:

1. Wired connection using either option below:

- Connect the LINKZONE to your computer using the provided Type-C cable.
- Connect one end of an Ethernet cable (sold separately) into the LAN port on the side of LINKZONE and the other end to your computer.

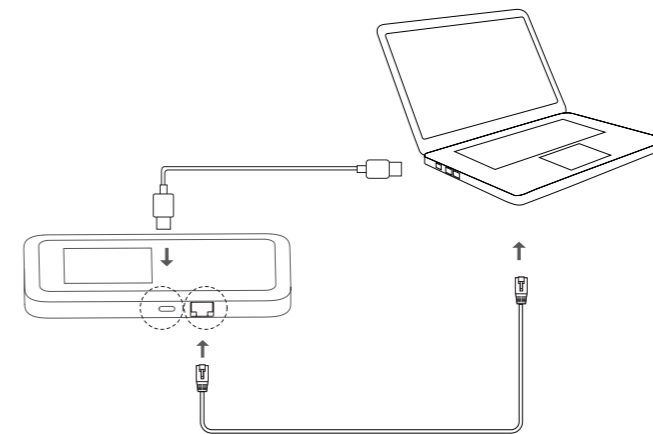

NOTE:

The Ethernet connection must be enabled before use. Go to **Menu>Settings>Ethernet>Enable** on the touchscreen to enable the connection.

2. Wireless Connection:

To establish wireless connection:

- a. Tap **“Wi-Fi Name/Password”** on the LINKZONE Home Screen.

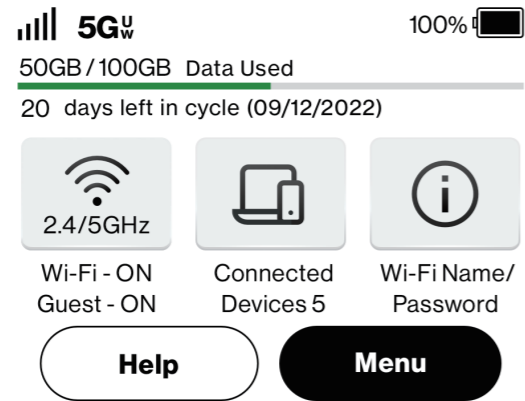

- b. Open Settings on your wireless device and turn on Wi-Fi.
- c. Select the network name (SSID) and enter the password. Your device will connect to the wireless network.
- Alternate QR code method: From your mobile device, scan the QR Code from your LINKZONE display to connect to a wireless network.



Note:

- This QR code is for demonstration purposes only. Not valid for hotspot connection.
- The QR code is printed inside the back cover of your LINKZONE. It won't work when you change your default password.

Chapter 4. Accessing the Touchscreen

You can view the device's status, manage your connected devices and customize settings using the touchscreen or Admin website. This chapter introduces how to use the touchscreen and what features you can manage on your touchscreen.

4.1 Homescreen

The Homescreen gives a glimpse of what your LINKZONE is doing.

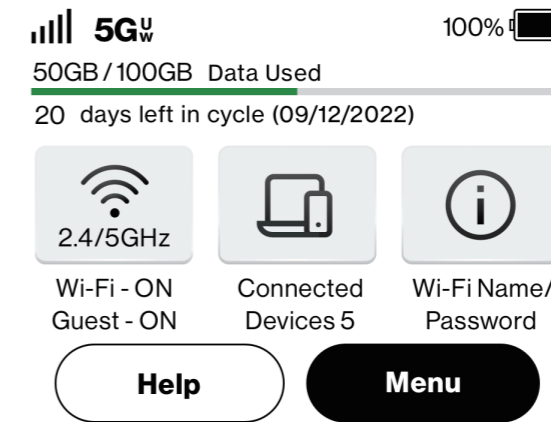

The status bar displays signal strength, network type (such as 5G), battery level, message notifications, roaming (R) and USB tetherings. The display also shows the amount of data (GB) used and the date your monthly billing cycle ends.

4.2 Wi-Fi

This panel allows you to know about the Wi-Fi status and select the appropriate band, and enable or disable guest network.

To manage Wi-Fi settings, tap  on the Homescreen or tap **Menu>Wi-Fi**.

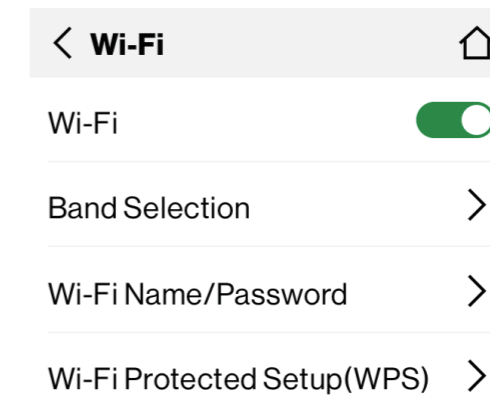

When Wi-Fi is enabled, you can select an appropriate band for your device. Each network can be accessed over 2.4 GHz and 5 GHz.

- The 2.4 GHz band transmits over longer distances and allows wall traversal but delivers slower speed;
- The 5 GHz band provides faster speed and reduced interference, but it doesn't pass

through walls.

- If you choose both 2.4 GHz and 5 GHz simultaneously, you can use your network to best potential.

Guest network

Enable or disable guest network to provide your guests an access to your home's network while keeping your network safe.

After the band is selected, tap < to return to the **Wi-Fi** page.

Wi-Fi Name/Password

Tap **Wi-Fi Name/Password** to view network name (SSID) and password for your selected band and guest Wi-Fi network. Refer to **Section 3.2 Connect to LINKZONE network** to access the network wirelessly.

NOTE: You can also change Wi-Fi network name and password on the Admin website. Connected devices may be disconnected from Wi-Fi.

Wi-Fi Protected Setup (WPS)

Wi-Fi Protected Setup (WPS) allows compatible Wi-Fi devices to easily connect to your LINKZONE network.

If WPS is turned off, follow the on-screen instructions to complete the process.

NOTE: You can also configure the WPS connection for your LINKZONE on the Admin website my.mobilehotspot. Check **Section 6.2** for more details.

4.3 Data Usage

Tap **Menu > Data Usage** to view the current data usage. This panel lists the current data usage and the data remaining for a billing cycle according to your billing plan.

4.4 Connected Devices

This panel lists all the devices that are connected to your LINKZONE. You can view the network information, block or unblock these devices from internet access.

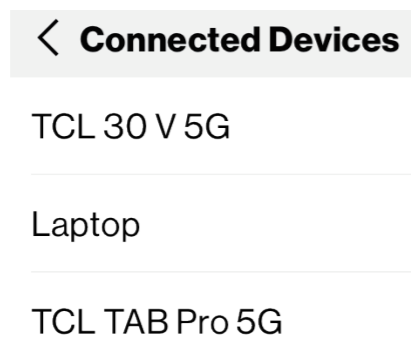

To block a connected device:

1. Go to **Menu>Connected Devices>Blocked Devices**.
2. Select the device that you want to block. The information of this device displays.
3. Tap **Block** and then **Confirm**. The device will be blocked.

To unblock a connected device:

1. Go to **Menu>Connected Devices**.
2. Select the device that you want to unblock from a list of blocked device. The information of this device will display.
3. Tap **UnBlock**. The device is removed from Blocked Devices list and added to Connected Devices list.

NOTE: If the MAC address is set to be included in the whitelist on the Admin webpage, the device cannot be blocked.

4.5 Messages

Go to **Menu > Messages** to view incoming messages and notifications. Your LINKZONE can receive text messages. This is useful for notifications from Verizon about your account. If a response is required, use another device. No messages display if no SIM card is detected.

4.6 Settings

Go to **Menu > Settings** to customize your device mode, languages or reset to factory settings. You can set your device to Airplane mode, stealth mode or sleep mode.

Item	Description
Airplane Mode	When the device is set to Airplane Mode, internet connection is disabled. To enable or disable Airplane mode, tap the ON/OFF slider.
Stealth Mode	When the device is set to Stealth Mode, the touchscreen will be off. Push the power button to wake up the screen.
Screen Timeout	Set the screen timeout period when the device is idle. The available options include 30 seconds (default), 1 Minute, 5 Minutes, 10 Minutes, Never .
Sleep Mode	The device will enter sleep mode if no device is connected. Select the duration for sleep mode. The available options include After 5 Minutes (default), After 10 Minutes, After 15 Minutes, After 30 Minutes, After 60 Minutes, Never Sleep . Push the power button to wake up the device.
Ethernet	Enable or disable Ethernet port, or choose Power Saving mode. When Power Saving mode is selected, Ethernet port will be disabled automatically if device is not connected within one minute.
Languages	Select the language for this device.

Factory Reset	<p>This function enables you to factory reset the LINKZONE.</p> <p>If the LINKZONE does not work properly, you can try restarting the device to solve the problem.</p> <p>If you can't access the internet for unknown reasons, or forget the login password, you can restore the LINKZONE to factory settings. To reset the LINKZONE, press the reset button by inserting a paperclip end into the open reset hole near the Ethernet port.</p> <p>Tap Factory Reset to restore all settings to default values. Your device will turn off and all connections are disabled. The device will restart automatically after recovery is completed.</p> <p>NOTE: Factory reset can be locked from the Admin website. To unlock, go to Settings>Restart & Reset.</p>
----------------------	--

4.7 Universal Charging

Universal charging enables you to charge other devices, such as a phone or tablet through your LINKZONE's Type-C port. This page displays battery and charging information.

NOTE:

- An On-The-Go (OTG) cable, sold separately, is required to charge other devices.
- The LINKZONE will stop charging other batteries at a preset limit to avoid damage and to preserve battery life for Wi-Fi operation. The battery level default is 25% and this level can be changed using the Admin website.

4.8 Software Update

Go to **Menu > Software Update**, and then the Software Update page displays on the screen. This panel allows you to view the current software version and check for available updates.

Tap **Check for update**, and the LINKZONE will detect software version. If a new version is available, you can tap Update to upgrade the software.

4.9 About

Go to **Menu > About** to check for specific information of your LINKZONE.

Model: displays the model name.

SW Version: The version of the software currently installed on your LINKZONE.

Mobile Device Number: The phone number stored in the SIM card for your LINKZONE .

Technology: The current cellular data connection, such as 5G.

IMEI: The International Mobile Equipment Identity (IMEI) for this device.

Battery Level: The percentage of charge currently on the battery.

Battery Status: The current battery status.

Internet Status: The current internet status.

Network: The name of operator.

Signal Strength: The strength of the cellular signal, measured in dBm.

SNR: Signal to Noise Ratio. A measure of the ratio between signal strength and noise level. SNR values are positive, and higher numbers are better.

Roaming: displays whether there is roaming or not.

APN: The Access Point Name (APN) available from the network, for example: vzwinternet.

IPv6/IPV4 Address: The Internet IP address assigned to your LINKZONE.

4.9 Help

This panel displays all help topics that may assist in solving your problems. Tap **Help** for more information.

Chapter 5. Accessing the Admin Web UI

5.1 Log in to the Admin Web UI

To log in to the web UI:

1. Open a web browser on the device connected to the LINKZONE network wiredly or wirelessly.
2. Go to <http://my.mobilehotspot.com> or <http://192.168.1.1>. The homepage displays.
4. Click **Show** beside the password and enter the Admin password. To enhance security for your home network, change your password.

To change Admin password:

1. Click "**Sign out**" in the top-right corner of any web page and follow the on-screen instructions to sign out.
2. Enter a new password and click **Save**. The default Admin password is changed.

Use the new password when you sign in to the Admin website next time.









Note: For the default login information, refer to the label underneath the battery of your LINKZONE.

5.2 Explore Admin web UI features

Home page features

The home page allows you to quickly manage and configure your LINKZONE. It displays Wi-Fi status, network connection status, and lists the connected devices. Click on each section to display more information about your LINKZONE.

Commonly-used status icons are displayed in the web UI, which give you information about your LINKZONE.

	This is the network your LINKZONE connects to. No Service will be displayed when there is no network available.
	The number of the signal bar indicates the signal strength. The more signal bars it shows, the stronger the signal is.
	The LINKZONE is connected to the network.
	The LINKZONE is disconnected from the network.
	New messages or unread messages.
	The SMS inbox is full.
	Wi-Fi is enabled.
	Wi-Fi is disabled.

Chapter 6. Configuring Your LINKZONE via the Admin Web UI

In this chapter, we will show you how to get the most out of your LINKZONE using the admin web UI. In the admin web UI, you can configure Wi-Fi settings, view connected devices, set up a guest network, and more.

6.1 Home

This section allows you to quickly check connection status, network information, device information, and connected devices.

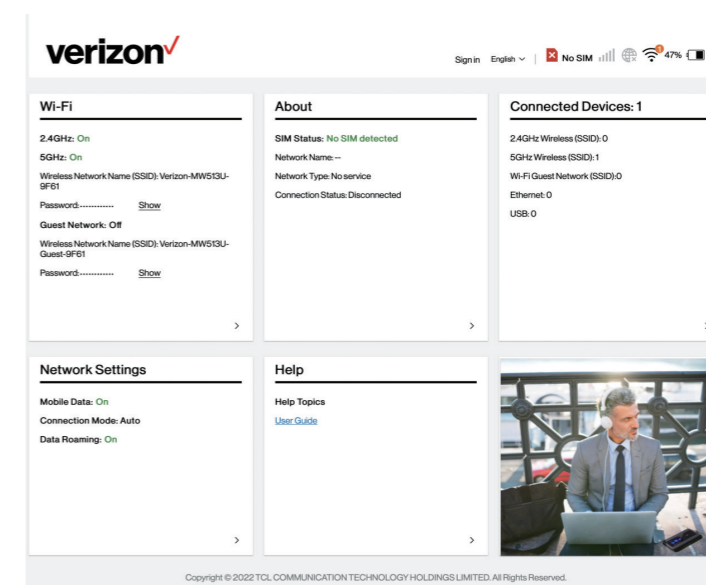

Wi-Fi

The **Wi-Fi** panel displays the current Wi-Fi status of primary and guest network. Click > to go to **Wi-Fi>Basic** page.

To turn on or off Wi-Fi, move the On/Off slider to the On or off status. When Wi-Fi is enabled, choose 2.4 GHz and/or 5 GHz. Enter the wireless network name (SSID) and password correspondingly.

About

The **About** panel displays SIM card status, network name, network type, and network connection status. Click > to go to **About>Internet** to know more about the internet settings.

SIM Status

If SIM card is not detected or cannot be read, make sure the SIM card is properly installed.

If SIM card is locked, click "Unlock your SIM" to jump to the **SIM PIN Management** page. Enter the SIM lock code and click **Apply**. Make sure you enter the code correctly, or the SIM card may be locked permanently. There is a limited number of attempts allowed.

Connected Devices

The **Connected Devices** panel displays the number of devices connected to your LINKZONE network by USB Cable, Ethernet or WI-FI.

Click **Connected devices** to get more detailed information on the connected devices.

Network Settings

The **Network Settings** panel displays network status and connection mode.

Click **Network Settings** to access the network settings page.

Help

The **Help** panel displays help topics which are useful for getting started with your LINKZONE .

Click **Help** to access the User Guide.

6.2 Wi-Fi

Your LINKZONE provides primary and guest networks for accessing the internet over Wi-Fi. Each network can be accessed over 2.4 GHz and 5 GHz.

To manage Wi-Fi settings, select > to go to Wi-Fi settings page. The page includes four tabs: Basic, Advanced, Guest Network and WPS.

Basic

Configure basic Wi-Fi settings in this option.

Wireless Network Name (SSID)	SSID is the name of the Wi-Fi network.
SSID Broadcast	This function is enabled by default. When this function is disabled, other users cannot detect the SSID or the Wi-Fi name. They need to manually enter SSID to connect to your LINKZONE network.
Security	The available security modes include WPA2, WPA/WPA2, WPA2/WPA3, WPA3, Disable . <ul style="list-style-type: none">• WPA2: used for WPA2 devices• WPA/WPA2: used for WPA-compatible devices• WPA2/WPA3: provides the most secure protection for WPA2 and WPA3-compatible devices• WPA3: an more advanced method with enhanced security• Disable: allows others to access the internet without any security mechanisms. Avoid using this option.

Encryption	The available option is AES .
Wi-Fi Password	Check the Wi-Fi password in this item.

If you move the slider to turn Wi-Fi off and click Apply, and then Wi-Fi is disabled. All connected devices over the Wi-Fi network will be disconnected from the network.

Band Selection

When Wi-Fi is enabled, you can select an appropriate band for your device. Each network can be accessed over 2.4 GHz and 5 GHz.

- The 2.4 GHz band transmits over longer distances and travels through walls better, but delivers slower speed;
- The 5 GHz band provides faster speed with reduced interference, but it doesn't pass through walls as easily as 2.4GHz.

Advanced

Your LINKZONE offers advances Wi-Fi settings for users with technical expertise.

Configure advanced Wi-Fi settings in this option.

Max. connected devices	You can decide how many client devices can connect to your LINKZONE network at a time.
Wi-Fi mode	The mode is set to 802.11 ax by default. The available options include 802.11 ax, 802.11 ac, 802.11a, 802.11n, and 802.11 b/g.
AP isolation	The AP isolation function enables you to create a separate virtual network for each wireless client that is connected to your LINKZONE network. When this function is enabled, all wireless devices in the network will not be able to communicate with each other.
Channel bandwidth	Select the available options from the drop-down menu.
Channel	The channel default option is Auto . The LINKZONE will select the best channel automatically.

NOTE: When you select 2.4 GHz only in the WiFi Basic page, 5 GHz option will be disabled on this tab.

Guest Network

In this tab, you can enable or disable the **Guest Network** feature, and configure guest network Wi-Fi name, Wi-Fi password, security method, and validity duration. After setup is complete, click **Apply** to save settings. Devices connected to the guest network can access the internet, but cannot access the LINKZONE web UI or the primary network.

WPS

Wi-Fi Protected Setup (WPS) is a wireless network security standard that tries to make connections between your LINKZONE and wireless devices faster and easier. It enables compatible devices to connect to a wireless network without entering the password.

If your wireless device is WPS-supported, you can access the LINKZONE Wi-Fi network through a WPS connection.

To make a WPS connection:

1. Log in to the web UI of your LINKZONE, and go to **Wi-Fi > WPS**. (For how to log in to the web UI, see "**Chapter 5. Accessing the Admin Web UI**" on page 16.)
2. Click **Start WPS**.
3. Enable the WPS function of your wireless device within 2 minutes to make a WPS connection.

When a WPS connection is established, the WPS icon will show on the upper right corner of the status bar. If the connection fails to be established, enter the Wi-Fi password manually.

NOTE: WPS will be disabled if W-Fi security is set to **WPA3, Disabled** or encryption is set to **AES**, or SSID broadcast is turned off.

6.3 Data Usage

Click > to go to Data Usage page to view the current data usage. This section displays the amount of data used and your monthly billing plan.

6.4 Connected Devices

This tab allows you to edit the connected device name, and manage internet access for connected devices. You can also block or unblock devices from the list of available devices.

6.5 Messages

This tab allows you to view your messages. Messages can not be sent or forwarded from the Mobile Hotspot. Use another mobile device to send messages.

Refer to the following table for the description of each folder under the **Messages** tab.

Messages	Incoming messages are stored in this folder. NOTE: Inbox messages does not display if the SIM card is not properly installed.
----------	---

Refer to the following table for commonly used operations of SMS messages.

Read a message	Click the message you want to read.
----------------	-------------------------------------

Delete a message	<ol style="list-style-type: none">1. Locate the message you want to delete in the Messages folder.2. Tick the checkbox beside the message you want to delete.3. Click Delete.
Delete all messages	<ol style="list-style-type: none">1. Click at the top of the checkbox column to select all messages.2. Click Delete.

6.6 Mobile Network

This tab allows you to prioritize the network connection, configure profile management, and more.

Network Connection

In this option, you can configure and manage mobile data, and data roaming. Connection mode is set to **Auto** and cannot be edited.

Profile management

In this option, you can edit the APN profile. Make sure you click **Apply** after making desired changes.

Network Settings



You can set the network search mode and change the network search mode.

Make sure you click **Apply** after making desired changes.

SIM PIN Management

If the SIM card is locked, click "Unlock the SIM card" to enter the **SIM PIN Management** page. (or navigate to **Mobile Network > SIM PIN Management** from the side bar.) You must enter the PIN before connecting to the network.

Refer to the following table to enable, disable or change SIM PIN code.

Enable SIM PIN	<ol style="list-style-type: none">1. When the SIM PIN feature is disabled, click .2. Set a SIM PIN code.3. Click Apply.
Disable SIM PIN	<ol style="list-style-type: none">1. When the SIM PIN feature is enabled, click .2. Enter the current SIM PIN code.3. Click Apply.

Change SIM PIN	<ol style="list-style-type: none"> 1. When the SIM PIN feature is enabled, click Change PIN. 2. Enter the new SIM PIN code. 3. Click Apply. <p>NOTE: If you have entered the SIM PIN incorrectly for 3 times, the SIM is PUK locked. The page will jump to Wi-Fi "PUK required" page. Follow the on-screen instructions to obtain the PUK code.</p>
----------------	---

Manual DNS

This tab allows you to manually assign two Domain Name Server (DNS) IP addresses.

Manual DNS

Move the ON/OFF slider to turn DNS on or off.

DNS 1/2 IP address

DNS1 IP address is the address for the master network, and it is a must to use the manual DNS feature. DNS2 IP address is optional and can be left blank.

DNS Rebinding

DNS Rebinding Protection

DNS rebinding is a kind of computer attack by manipulating resolution of domain names. When DNS Rebinding Protection is enabled, your device is protected from DNS rebinding attack. If you leave this option to Disabled, your device is exposed to cyber attack. Never allow this option to Disabled.

Loopback Address Range

The loopback address range lists IPv4 addresses that are reserved for loopback, usually starting from 127.0.0.1 to 127.225.225.225.

If DNS Rebinding Protection is enabled, the IP addresses within this range will be protected from cyber attack.

Click **Apply** to save the settings.

6.7 Parental Controls

Set internet access schedule for the client devices on the LINKZONE network, and define which websites the client devices can and cannot visit.

To manage parental control, enable the status and click **Set**, then set internet access schedule and specify website blacklist.

6.8 Settings

Log in Password

This tab allows you to change the login password. Enter the current and new password and then click **Apply** to save the changes.

Universal Charging

You can charge other devices such as phone or tablet through the Type-C port using your LINKZONE. You can select the battery percentage to configure when you want to stop charging other devices. Click **Apply** to save the settings.

Backup & Restore

This feature allows you to back up the current device configuration, or restore the device to a previous configuration by importing the backup configuration file.

To back up the current device configuration, enter Admin password and click **Apply**.

NOTE: You will be locked out if the password is entered incorrectly for 5 times.

To restore the configuration to previous settings:

1. Enter the admin password in the **Admin password** field.
2. Click **Browse** in the **Select a file** field to select a file downloaded from your computer.
3. Click **Restore**. The configuration is restored to previous settings.

NOTE: Restoring settings will disconnect devices from the network and reset network names and passwords.

Restart & Reset

This function enables you to restart or factory reset the LINKZONE.

If the LINKZONE does not work properly, you can try restarting the LINKZONE to solve the problem.

If you can't access the internet for unknown reasons, or forget the login password, you can restore the LINKZONE to factory settings. To reset the LINKZONE, press the sharp end of an unfolded paperclip in the reset hole for 3 seconds. The reset hole is located near the Ethernet port.

Advanced Settings

Ethernet & USB

This option allows you to enable or disable Ethernet and USB tethering.

LAN

The default gateway address is 192.168.1.1, and the default subnet mask is 255.255.255.0. With the **DHCP server** function enabled, IP addresses will be assigned automatically to

client devices in the network. If the **DHCP server** function is disabled, the LINKZONE will not assign IP addresses to the connected client devices. The IP address must be entered on each client device.

IP filter

By default, any device connected to your LINKZONE network is allowed to access the internet. Specify which device cannot access the internet by adding the device to the blacklist.

MAC filter

By default, any device connected to your LINKZONE network is allowed to access the internet. You can specify which device can or cannot access the internet by adding the device to the blacklist or whitelist.

Disable	All connected devices can access the internet.
Whitelist	Only devices with a MAC address in this list can access the internet.
Blacklist	Devices with a MAC address in this list cannot access the internet.

DDNS

WAN IP address is needed when some functions of your LINKZONE are enabled. If the WAN IP address of your LINKZONE changes, these functions may not work properly.

The Dynamic Domain Name Server (DDNS) function allows you to map a dynamic WAN IP address (public IP address) to a static domain name, helping internet users (WAN side) access the LINKZONE network by static domain name.

UPnP

Universal Plug and Play (UPnP) is a set of networking protocols that allows connected devices to discover each other and establish functional network services for data sharing, communications, and entertainment.

DMZ

The DMZ separates LAN from the public internet. Certain network services in DMZ cannot be accessed by external users. You can enable the DMZ function and set a new host IP address to allow access .

VPN

Virtual Private Network (VPN) is a dedicated network across the shared or public network (usually the internet). The VPN technology allows employees at a branch of an enterprise and employees at the headquarters to exchange resources conveniently without exposing these resources to other internet users.

Port Forwarding

This function directs the network services from your computer to a designated device on your network.

Port Filtering

This function allows you to prevent the selected applications from accessing the internet. You can customize additional applications through Start and End port or protocols.

6.9 Software Update

This section allows you to check for software updates if available. Click **Check for update**, and the LinkZone will detect software version. If a new version is available, you can click **Update** to upgrade the software.

This function can also be managed through the touchscreen.

NOTE: Do not power off the device during the upgrade process. Otherwise, it may be damaged.

6.10 About

This section displays internet information, diagnostics, and device information.

Internet

You can quickly view the SIM status, connection status, network name, type, and IPv4/IPv6 address.

Diagnostics

This tab displays detailed information for troubleshooting. The information includes RSSI, cell ID, RSRP and SNR.

Device information

You can view device information in this tab, including IMEI, software version, and MAC address.

6.11 Help

Click **Help** to access the user manual.

Chapter 7. Configuring your LINKZONE using the TCL Connect app

You can also use the TCL Connect app to configure your LINKZONE. This easy-to-use app provides you with easy access to your LINKZONE.

7.1 Download the TCL Connect app

Download the TCL Connect App using one of the following two methods:

- Download it from Google Play (running on Android 5.0 or higher) or App Store (running on iOS 11.0 or higher).
- Scan the QR code printed on the box to download the TCL Connect app.



Follow the on-screen instructions to install the TCL Connect app.

7.2 Pair your phone or tablet with the LINKZONE

After the TCL Connect App is installed on your phone or tablet, a message pops up, prompting you to pair your device with the LINKZONE. For the first-time use, follow the on-screen instructions to complete the configuration process.

There are two ways to connect your device with your phone or tablet:

- Scan the QR code

Scan the QR code located on the device's back cover. Your phone or tablet will automatically connect to the Wi-Fi of your selected device. No need to enter your account and password manually.

- Enter the password

Open the TCL Connect App, and tap on the **TCL LINKZONE 5G UW** icon. Enter the Wi-Fi name (SSID) and password. Tap **Connect**.

7.3 Use the TCL Connect app

Home

The homepage displays connection status, network information, connected devices, and more. It also shows the amount of data (GB) and the date your monthly billing cycle ends.

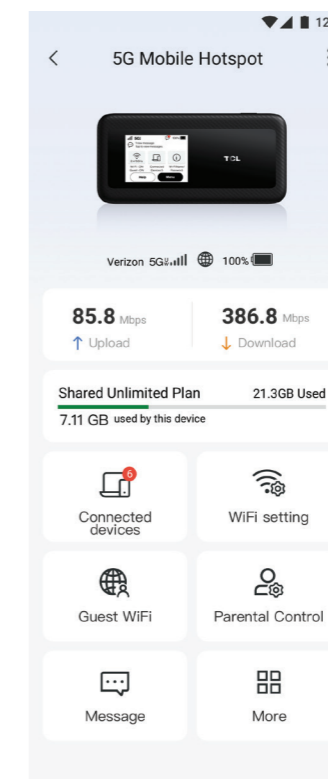

App status icon

Status icon	What it means
5G	Indicates the network your LINKZONE connects to. No Service will be displayed when there is no network available.
Signal bars	The number of signal bars indicates the signal strength. The more signal bars it shows, the stronger the signal is.
Signal bars with 'R'	Data roaming is enabled. The number of signal bars indicates the signal strength. The more signal bars it shows, the stronger the signal is.
Internet icon	The LINKZONE is connected to the internet.
Internet icon with 'X'	The LINKZONE is disconnected from the internet.
No SIM card icon	No SIM card/ Invalid SIM card
Up arrow	Show the real-time upload speed of your LINKZONE.
Down arrow	Show the real-time download speed of your LINKZONE.

Connected devices

On the homepage, tap **Connected devices** to enter the Connected devices page. You can configure access to the internet for any connected devices. Connected devices are shown in the **Connected** list, any devices which have been forbidden to connect to the

internet are shown in the **Blocked** list. It is possible to enable or disable internet access for each device. You may also rename each connected device.

Wi-Fi settings

Go to homepage and tap **WiFi Settings** to enter Wi-Fi Settings page. Your LINKZONE provides primary and guest networks for accessing the internet over Wi-Fi. Each network can be accessed over 2.4 GHz and 5 GHz. Select the options and tap **Save** to save settings.

SSID	SSID is the name of the Wi-Fi network.
Password	The Wi-Fi password can be checked here.
Hide WiFi	When this option is enabled, the SSID will not appear in the list of Wi-Fi network stations.

Guest network

Go to homepage and tap **Guest network** to configure guest network. A guest network allows guests to access the internet only without accessing the primary network. When the guest network feature is enabled, you can configure the guest network Wi-Fi name, Wi-Fi password and validity duration for a guest network. After setup is complete, tap **Save** to save settings.

Parental Control

Go to homepage and tap **Parental Control** to enable or disable parental control features.

This function enables the administrator to block specific devices from accessing specified URL(s) during set time periods. To manage parental control, enable the status and set internet access schedule and specify website blacklist.

NOTE:

Blocking a URL may not block the associated app. For example, adding www.facebook.com may not block the specified device from using the Facebook app.

Messages

Go to homepage and tap **Messages** to view and delete your messages. Refer to the following table for commonly used operations of SMS messages.

Read a message	Tap the message you want to read.
Delete a message	<ol style="list-style-type: none"> 1. Locate the message you want to delete in the Message folder. 2. Tick the checkbox beside the message you want to delete. 3. Click Delete.

Delete all messages	<ol style="list-style-type: none"> 1. Tap Select all at the top of the checkbox column to select all messages. 2. Click Delete.
---------------------	---

More

Go to homepage and tap **More** to configure more settings.

Mobile network settings

Tap **Mobile network settings** to enter Mobile network settings page.

You can enable or disable the mobile data and data roaming options, and set the network mode to either Auto(5G/4G)or 4G. Make sure you tap **OK** after making any desired changes.

NOTE: The mobile data can only be enabled when the network is available. If your network is not available, tap "Disconnect" and try again.

PIN Settings

To enable PIN code:

1. When SIM PIN is disabled, tap  .
2. Enter a SIM PIN.
3. Tap **OK**.

To unlock PUK, enter PUK and create a new PIN. Tap **Save** to save settings.

To disable PIN code:

1. When SIM PIN is enabled, tap  .
2. Enter the current SIM PIN.
3. Tap **OK**.

To change PIN code:

1. When SIM PIN is enabled, tap **Change PIN**.
2. Enter the original SIM PIN and create a new PIN. Then Confirm PIN.
3. Tap **OK**.

NOTE: When a SIM PIN is entered incorrectly 3 times, your SIM will lock and a PUK code is required. You can get the PUK code by calling customer services from your operator.

Password settings

To change the login password, enter your current password, and set a new one.

Data Usage

This option displays the amount of data used and your monthly billing plan.

Universal Charging

You can charge other devices such as phone or tablet through the USB-C port using your LINKZONE. You can select the battery percentage to configure when you want to stop charging other devices. Tap **Save** to save settings.

Firmware update

Go to **More > Firmware update** to enter firmware update page. Tap **Check for update**, and the LINKZONE will detect software version. If a new version is available, go to device screen or <http://my.mobilehotspot> to complete the firmware update.

Note: Do not power off the LINKZONE during the upgrade process. Otherwise, it may be damaged.

Factory Reset

If you can't access the internet for unknown reasons, or forget the login password, you can restore the LINKZONE to factory settings. To reset the LINKZONE, use the sharp end of a paperclip to press the reset hole for 3 seconds. The reset hole is located near the Ethernet port.

Reboot

If the LINKZONE does not work properly, you can try restarting the LINKZONE to solve the problem.

User manual

Access the App user manual in this category.

7.4 Unbind

To unbind your device from the app:

1. Go to the homepage and go to **More > Unbind**.
2. Tap **Unbind**.

Chapter 8. Troubleshooting

If you encounter problems while using the product, use the troubleshooting information to help determine the problem and find possible solutions.

General problems

Problem	Solution
I forgot the Wi-Fi password.	<ul style="list-style-type: none">• On the touchscreen: tap Wi-Fi Name/Password to check your Wi-Fi name (SSID) and Wi-Fi password.• On the Admin web UI: Go to Wi-Fi > Basic. Check Wi-Fi password.• On the TCL Connect app: Go to homepage and tap WiFi Settings to enter Wi-Fi Settings page.• Or use the sharp end of a paperclip to press the reset button for 3 seconds to factory reset the device. Then create a new one.
How do I change the Wi-Fi name and password?	Log in to the web UI. Go to Wi-Fi > Basic .
I can't find the Wi-Fi name of the LINKZONE on my wireless device.	<ul style="list-style-type: none">• Make sure the indicator of your LINKZONE is solid blue or green.• Refresh the available network list on your wireless device.
How do I set a new PIN code for my SIM card?	Log in to the web UI. Go to Mobile Network > SIM PIN management . Enable PIN operation, and enter a new PIN code. Click Apply .
Where can I find the device's firmware version?	On the touchscreen: Tap Menu > Software Update . On the Admin Web : a. Log in to the web UI. b. Go to Software Update > Check for Update .

Web UI problems

Problem	Solution
How can I access the web UI?	Open the web browser, and go to http://my.mobilehotspot.com or 192.168.1.1. Enter the login information as required. Find the default login information on the label underneath the battery.

I can't log in to the web UI.	<ul style="list-style-type: none"> • Make sure the login website is entered correctly in the web browser. • Make sure the LINKZONE is powered on. • Check whether the device is connected to the LINKZONE network properly.
How do I change the login password?	Log in to the web UI. Go to Settings > Log in password.
"No SIM card" or "Invalid SIM card" is displayed on the web UI.	<ul style="list-style-type: none"> • Make sure there is a SIM card in your LINKZONE. • Reinstall the SIM card, and log in to the web UI again. <p>NOTE: Power off your device before removing the SIM card.</p>

Connection problems

Problem	Solution
I can't connect to LINKZONE Wi-Fi.	<ul style="list-style-type: none"> • Make sure you've connected to the Wi-Fi network correctly. • Make sure you've entered the correct network name and password. If the password has been changed, select "forget the current network" in the Wi-Fi > Basic page and create a new one.
I can't access the internet.	<ul style="list-style-type: none"> • If no SIM card is detected, power off your LINKZONE. Reinstall the SIM card, then try again. • If a PIN code is required, enter the PIN code, and try again. • If no network is available, place the LINKZONE in an area with better signal (for example near a window), and try again. • Reboot your LINKZONE, and try again.
How can I access the LINKZONE network wirelessly?	<p>Select the Wi-Fi name (or the SSID) of the LINKZONE on your wireless devices, and enter the Wi-Fi password.</p> <p>NOTE: The default Wi-Fi name and the Wi-Fi password can be found on the label underneath the battery.</p>
"PIN lock" or "PUK lock" is displayed on the screen of the device connected to the LINKZONE network.	<p>This indicates that the SIM card is locked.</p> <p>To unlock the SIM card, log in to the web UI and enter the PIN code or PUK code. To obtain the PUK code, contact your internet service provider.</p> <p>NOTE: If the PIN code is entered incorrectly 3 times, you will be required to enter the PUK code. If the PUK code is entered incorrectly 10 times, the SIM card will be locked permanently.</p>

Appendix A. Important safety information

Read all the safety information before using your product. Failure to follow these safety instructions could result in injury, or damage to your product or other property.

Important safety instructions

- Observe signs and notices that prohibit or restrict the use of wireless devices.
- Always handle your device with care. It contains sensitive electronic components inside. The device can be damaged if dropped, burned, punctured, or crushed, or if it comes in contact with liquid.
- Do not disassemble or attempt to repair your device yourself. Disassembling the device may damage it, or cause injury to you.
- The device and its accessories may present a choking hazard to small children. Do not let children use the device and its accessories without supervision.

Medical device interference

Your mobile hotspot contains components which may interfere with medical devices such as pacemakers, defibrillators, or other medical devices. Maintain a safe distance of separation between your medical device and your mobile hotspot. Consult your physician and medical device manufacturer for information specific to your medical device.

Power adapter

Use only wall chargers that are compliant with the applicable international and regional safety standards. Using other wall chargers could cause damage to the device or pose a risk of injury or death. It is important to keep the wall charger in a well-ventilated area when the wall charger is plugged into an electrical outlet. Don't use damaged wall chargers.

Operating temperature

Your device is designed to work best in ambient temperatures between 0°C and 45°C (32°F and 113°F), and should be stored between ambient temperatures of -10°C and 70°C (14°F and 158°F). Your device may malfunction if operated or stored outside of these temperature ranges. Avoid exposing the device to dramatic changes in temperature or humidity.

Regulatory compliance information

This section introduces regulatory information, certification, and compliance information specific to your product.

Electromagnetic fields (EMF)

This product complies with all applicable standards and regulations regarding exposure to electromagnetic fields.

European Union (EU) compliance



Hereby, TCL Communication Ltd. declares that the radio equipment type TCL MW513U is in compliance with the essential requirements and other relevant provisions of Directive 2014/53/EU. You can find the Declaration of Conformity at:

<https://www.tcl.com/global/en/service-support-mobile/eu-doc.html>.

Disposal and recycling information

At TCL, we continually strive to improve our operations and products, and minimize our impact on the environment.



Your product is designed and manufactured with high quality materials and components, which can be recycled and reused. Please observe the local regulations regarding the disposal of packaging materials, exhausted batteries and old equipment. For recycling information, please visit www.tcl.com.



This symbol on your device and/or its accessories indicates that this device should not be disposed of with household waste. When this device reaches its end of life, take it to a collection point designated by local authorities. For more detailed information about device recycling, contact your local authorities, household waste disposal centers, or retail stores.

The separate collection and recycling of your device and/or its accessories at the time of disposal will help conserve natural resources and ensure that it is recycled in a manner that protects human health and the environment.