

# *Installation Manual*

## **FISH SIZE INDICATOR**

### **Model FCV-2100**

---

(Product Name: FISH FINDER)

<b>SAFETY INSTRUCTIONS .....</b>	<b>i</b>
<b>SYSTEM CONFIGURATION .....</b>	<b>ii</b>
<b>EQUIPMENT LISTS.....</b>	<b>iii</b>
<b>1. MOUNTING.....</b>	<b>1-1</b>
1.1 Processor Unit .....	1-1
1.2 Transceiver Unit.....	1-2
1.3 Transducer.....	1-3
1.4 Trackball Control Unit .....	1-4
1.5 Monitor (Local Supply).....	1-7
<b>2. WIRING.....</b>	<b>2-1</b>
2.1 Processor Unit .....	2-1
2.2 Transceiver Unit.....	2-6
2.3 Data Sentences .....	2-14
<b>3. INITIAL SETTINGS.....</b>	<b>3-1</b>
3.1 How to Set the Language and Measurement Unit .....	3-1
3.2 How to Set the Service Menu .....	3-2
3.3 Communication Port Setting .....	3-5
3.4 External Echo Sounder Setting.....	3-8
3.5 Calibration Setting.....	3-11
3.6 Stabilization Setting .....	3-15
3.7 Reset to Default Setting .....	3-17
<b>APPENDIX 1 JIS CABLE GUIDE .....</b>	<b>AP-1</b>
<b>PACKING LISTS .....</b>	<b>A-1</b>
<b>OUTLINE DRAWINGS .....</b>	<b>D-1</b>
<b>INTERCONNECTION DIAGRAM.....</b>	<b>S-1</b>



**FURUNO ELECTRIC CO., LTD.**

[www.furuno.com](http://www.furuno.com)

All brand and product names are trademarks, registered trademarks or service marks of their respective holders.

**ECF**

(Elemental Chlorine Free)

The paper used in this manual  
is elemental chlorine free.

**FURUNO ELECTRIC CO., LTD.**

9-52 Ashihara-cho,  
Nishinomiya, 662-8580, JAPAN

• FURUNO Authorized Distributor/Dealer

All rights reserved. Printed in Japan

Pub. No. IME-23910-D

(GREG ) FCV-2100

A : APR. 2016

D : MAR. 11, 2021





0 0 0 1 9 1 3 8 3 1 3















# SAFETY INSTRUCTIONS

The installer must read the appropriate safety instructions before attempting to install the equipment.

 <b>WARNING</b>	Indicates a potentially hazardous situation which, if not avoided, could result in death or serious injury.
 <b>CAUTION</b>	Indicates a potentially hazardous situation which, if not avoided, could result in minor or moderate injury.

 Warning, Caution	 Prohibitive Action	 Mandatory Action
----------------------------------------------------------------------------------------------------	------------------------------------------------------------------------------------------------------	------------------------------------------------------------------------------------------------------

 <b>WARNING</b>	
	<b>ELECTRICAL SHOCK HAZARD</b> Do not open the equipment unless totally familiar with electrical circuits and service manual.  Only qualified personnel are allowed to work inside the equipment.
	<b>Turn off the power at the switchboard before beginning the installation.</b>  Fire or electrical shock can result if the power is left on.
	<b>Install the transducer according to the installation instructions.</b>  Failure to install the transducer correctly may result in water leakage and damage to the ship's hull.
	<b>Be sure no water leaks in at the transducer mounting location.</b>  Water leakage can sink the vessel. Also, confirm that vibrations will not loosen the transducer. The installer of the equipment is solely responsible for the proper installation of the equipment. FURUNO will assume no responsibility for any damage associated with improper installation.
	<b>For wooden or FRP vessel using a steel tank, attach a zink plate to the hull to prevent electrolytic corrosion.</b>  Electrolytic corrosion can, in the worst case, result in loss of the transducer.

 <b>CAUTION</b>													
	<b>Ground the equipment to prevent mutual interference.</b>												
	<b>Do not transmit with the transducer out of water.</b>  The transducer may become damaged.												
	<b>Use the proper cable and fuse.</b>  Use of an incorrect cable and fuse can damage the equipment and cause fire.												
	<b>Observe the following compass safe distance to prevent interference to a magnetic compass:</b>												
	<table border="1"> <thead> <tr> <th></th> <th>Standard compass</th> <th>Steering compass</th> </tr> </thead> <tbody> <tr> <td>FCV-2101</td> <td>0.35 m</td> <td>0.30 m</td> </tr> <tr> <td>FCV-2102</td> <td>1.70 m</td> <td>1.05 m</td> </tr> <tr> <td>TCU-001</td> <td>0.30 m</td> <td>0.30 m</td> </tr> </tbody> </table>		Standard compass	Steering compass	FCV-2101	0.35 m	0.30 m	FCV-2102	1.70 m	1.05 m	TCU-001	0.30 m	0.30 m
	Standard compass	Steering compass											
FCV-2101	0.35 m	0.30 m											
FCV-2102	1.70 m	1.05 m											
TCU-001	0.30 m	0.30 m											
	<b>The transducer cable must handled carefully, following the guidelines below.</b> <ul style="list-style-type: none"> <li>- Keep the cable away from oil and fuels.</li> <li>- Keep the cable away from locations where it may be damaged during the installation.</li> <li>- Do not carry the transducer using only the cable. The cable may become damaged or disconnected.</li> <li>- Do not shorten the transducer cable.</li> <li>- Do not paint the cable.</li> </ul> The cable sheath is made of chloroprene or vinyl chloride, which are easily damaged by plastic solvents such as toluene. Locate the cables away from plastic solvents.												

# SYSTEM CONFIGURATION

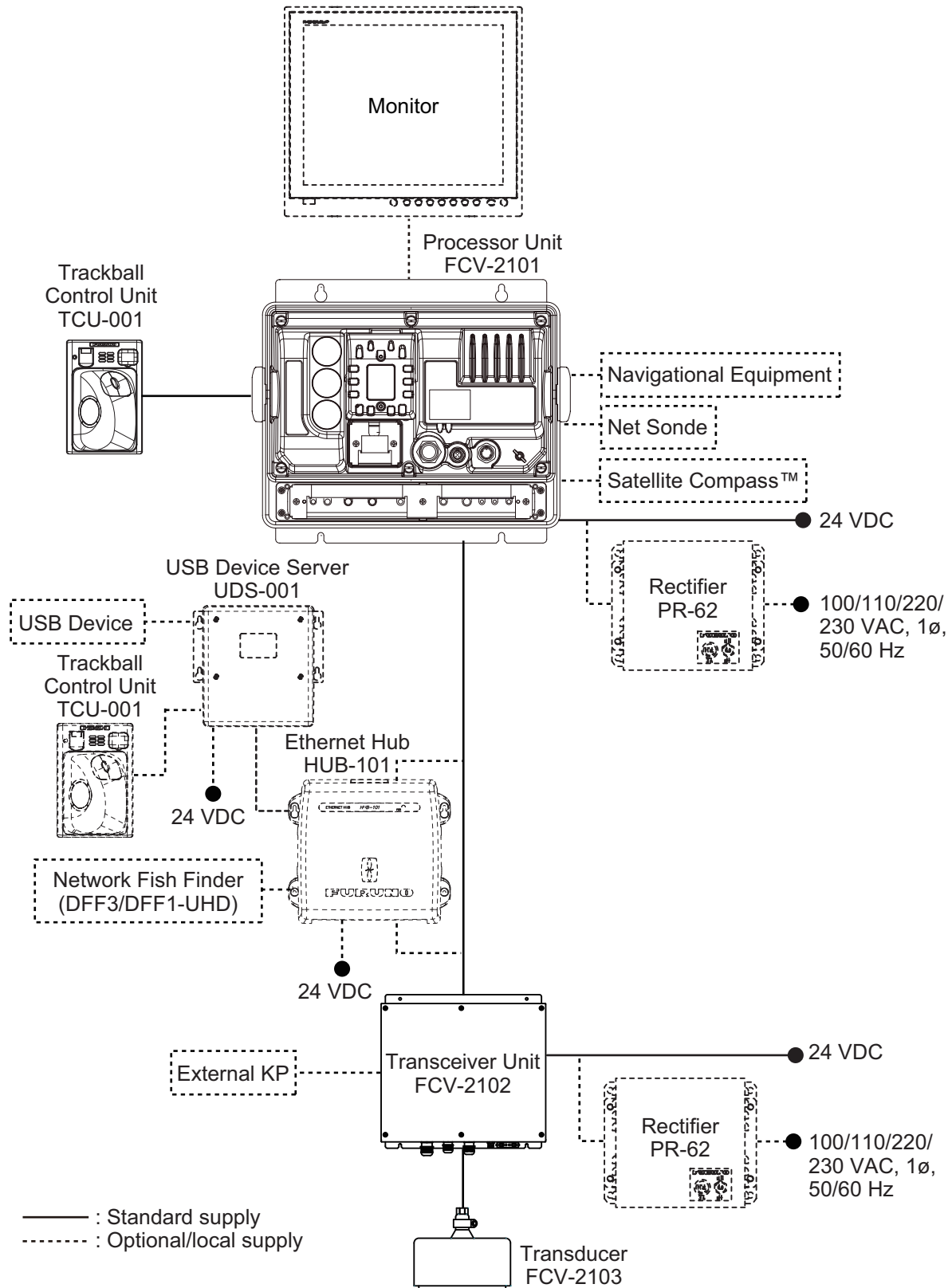



# EQUIPMENT LISTS

## Standard Supply

Name	Type	Code No.	Qty	Remarks
Processor unit	FCV-2101	-	1	
Transceiver unit	FCV-2102	-	1	
Transducer	FCV-2103	-	1	
Trackball control unit	TCU-001	-	1	
Installation materials	CP02-09500	000-030-008	1	For processor unit
	CP02-09300	000-029-457	1	For transceiver unit
	CP14-06801	001-303-390	1	For trackball control unit
Accessory	FP19-01801	001-205-650	1	For processor unit
Spare parts	SP14-03601	001-246-900	1	For processor unit
	SP24-00301	001-041-310	1	For transceiver unit

## Optional Supply

Name	Type	Code No.	Remarks	
USB device server	UDS-001	-	w/ Installation guide	
Flush mount kit	OP14-70	001-132-700	For trackball control unit.	
Rectifier	PR-62	-	For 100/110/220/230VAC	
LAN cable assembly	MOD-Z072-020+	001-167-880-10	2 m	For between processor unit and transceiver unit
	MOD-Z072-050+	000-167-890-10	5 m	
	MOD-Z072-100+	001-167-900-10	10 m	
Installation material	CP03-28900	000-082-658	10 m w/ armor	
	CP03-28910	000-082-659	20 m w/ armor	
	CP03-28920	000-082-660	30 m w/ armor	
	CP03-28930	000-084-368	50 m w/ armor	
	CP03-28940	000-090-429	100 m w/ armor	
Ethernet HUB	HUB-101	-	w/ Installation guide	
Cable assembly	DVI-D/D S-LINK5M	001-132-960-10	5 m for monitor	
	DVI-D/D S-LINK10M	001-133-980-10	10 m for monitor	
Thru-hull pipe	TFB-5000 (1)	-	For steel hull	
	TFB-1000 (1)	-	For FRP hull	

This page is intentionally left blank.

# 1. MOUNTING

---

## NOTICE

Do not apply paint, anti-corrosive sealant or contact spray to coating or plastic parts of the equipment.

Those items contain organic solvents that can damage coating and plastic parts, especially plastic connectors.

## 1.1 Processor Unit

The processor unit can be installed on a tabletop or bulkhead. When selecting a mounting location, keep in mind the following points:

- Locate the unit out of direct sunlight.
- Install the unit away from areas subject to water splash or rain.
- Select an installation location that is well ventilated.
- Do not prevent ventilation of the outer fitted fan.
- Locate the unit where shock and vibration are minimal.
- Leave sufficient service clearance around the unit. Refer to the outline drawing at the back of this manual.
- Keep in mind the compass safe distance shown on page i.
- Locate the unit in the environmental condition permitted. (-15 °C to +55°C, IP22)
- Face the cable connectors downward for bulkhead mount.

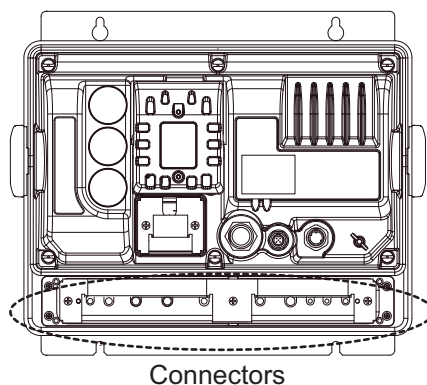

### How to mount the processor unit

Follow the procedure below to mount the processor unit on a bulkhead or a tabletop.

1. Attach the washers and knobs to both side of processor unit.  
**Note:** Attach the included sealing sticker to the holes at the screws on both sides, when the knobs are not used.

## 1. MOUNTING

2. Drill four pilot holes in the bulkhead or panel on a tabletop for self-tapping screws. Refer to the outline drawing at back of this manual for mounting dimensions.
3. Fasten four self-tapping screws ( $\phi 6 \times 20$ ) into the pilot holes, leave 5 mm protruding.
4. Hang (or set) the processor unit to the screws, then slide the processor unit downward (or to the front).

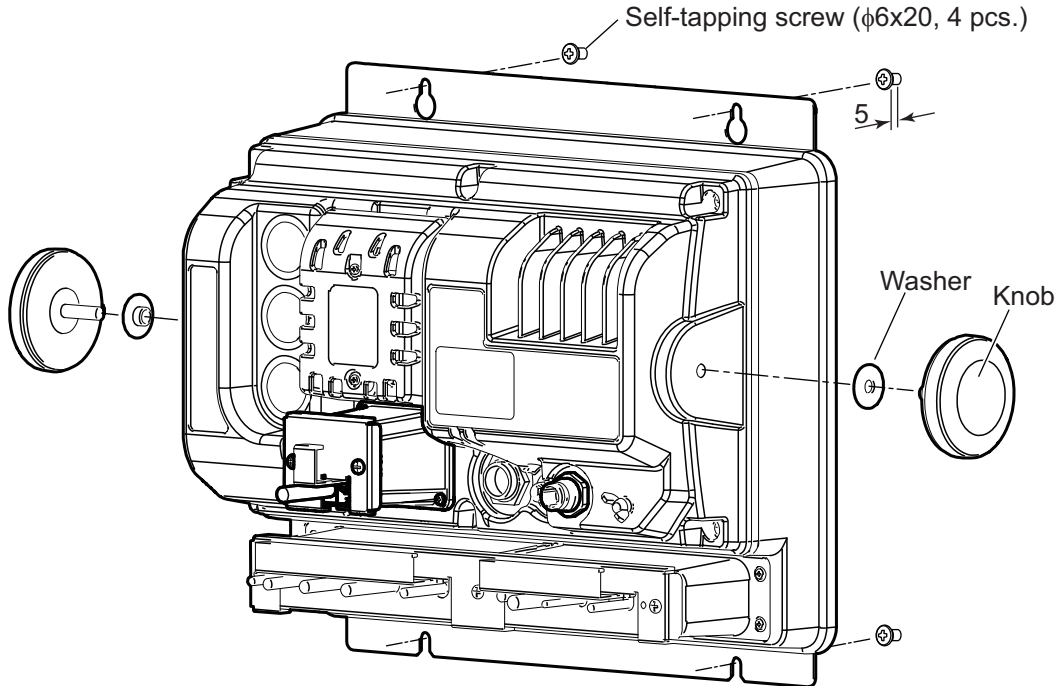

5. Fasten the screws to secure the unit in place.

## 1.2 Transceiver Unit

The transceiver unit can be installed on a tabletop or bulkhead. When selecting a mounting location, keep in mind following points:

- Locate the unit out of direct sunlight.
- Select an installation location that is well ventilated.
- Locate the unit where shock or vibration is minimal.
- Keep sufficient service clearance around the unit for maintenance.
- Keep in mind the compass safe distance shown on page i.

- Face the cable connectors downward for bulkhead mount.

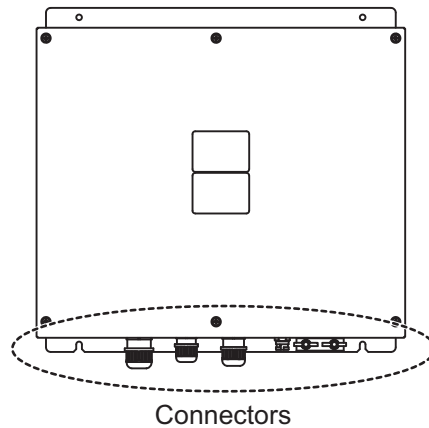

### **How to mount the transceiver unit**

1. Drill four pilot holes in the bulkhead or tabletop for self-tapping screws.
2. Screw two self-tapping screws ( $\phi 5 \times 20$ ) into the lower pilot holes, leave 5 mm protruding.
3. Hang (or set) the notches of transceiver unit onto the screws.
4. Screw two self-tapping screws into the upper fixing holes.
5. Fasten the screws to fix the unit in place.

## 1.3 Transducer

### **NOTICE**

**Do not install the transducer on the inner side of the hull.**

**The signal strength is reduced and may affect the accuracy of measurements.**

**Do not cover the transducer with FRP resin. The heat generated when the resin hardens may damage the transducer.**

For mounting the transducer, use a flange for transducer tank.

The performance of the fish finder depends on the transducer position. When selecting a mounting location, keep in mind following points.

- A place least affected by air bubbles should be selected since turbulence blocks the sounding path.
- Select a place least influenced by engine noise.
- Select a place without other sounder interference. The transducer should be separated from other transducers with the same frequency by 2.5 m or farther.
- Install the transducer face parallel to the sea surface.

## 1. MOUNTING

- Orient the transducer fore mark to ship's bow within  $\pm 5$  degree.

It is known that air bubbles are fewest at the place where the bow first falls and the next wave raises, at usual cruising speed. In small, slow-speed boats, the position between 1/2 and 2/3 of the ship's length from the bow is usually a good place.

Refer to the drawing for transducer tank installation at the end of this manual. The transducer tank T-615 (code: 000-015-841) should be prepared locally.

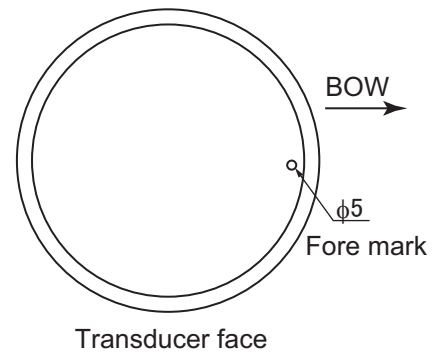

**Note:** The face of the transducer must be facing the sea bottom in normal cruising trim of the boat.

### **2100 data sheet sticker**

The transducer is supplied with three data sheet stickers. Remove the stickers from the base of the transducer cable and attach them at places as follows.

Refer to paragraph 2.2.2, step 9 for detail of attachment.

- [FCV-2103 30M] sticker: to the end of transducer cable.
- [TRANSDUCER DATA] sticker: to the cover of transceiver unit and the back cover of operator's manual.

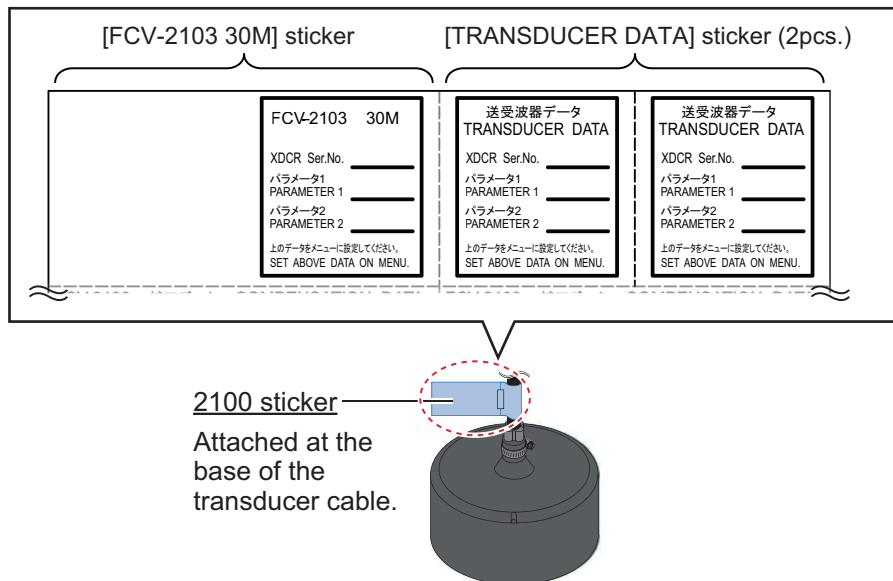

## 1.4 Trackball Control Unit

The trackball control unit can be installed on a tabletop or flush mounted in a console. Flush mounting requires the optional flush mount kit.

### **Installation considerations**

- Select a location where the control unit can be operated easily.
- Locate the unit away from heat sources, because heat can build up inside the cabinet. Heat build-up can damaged the unit.

- Locate the unit away from places subject to water splash and rain.
- Leave sufficient clearance at the sides and rear of the unit to facilitate maintenance.
- Determine the location considering the length of the signal cable between this unit and the processor unit.
- Keep in mind the compass safe distance shown on page i.

### 1.4.1 How to mount the unit on a desktop

You can install the unit flat on the desktop, or use the fixing plate for a tilted installation.

#### **Mounting with fixing plate**

1. Attach the fixing plate onto the trackball control unit from rear side with two screws (M3x8, supplied).

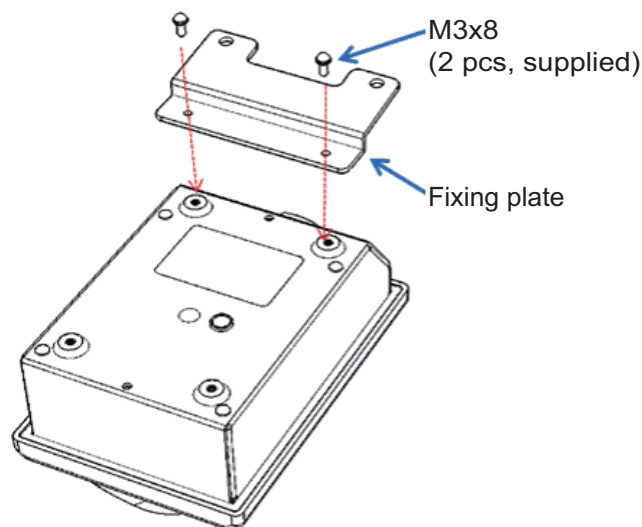

2. Secure the fixing plate to the desktop with two self-tapping screws ( $\phi 5 \times 20$ , supplied).

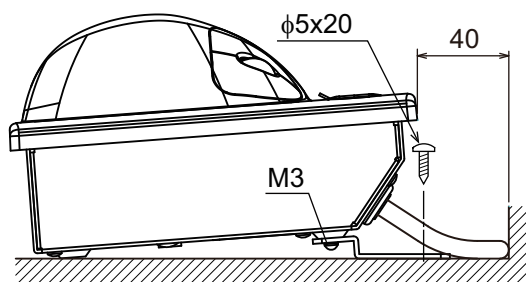

## 1. MOUNTING

### Surface mounting

1. Drill four holes ( $\phi 4$ ) on the table referring to the outline drawing at the back of this manual.
2. Secure the trackball control unit with four screws (M3, local supply) from the underside of the table. The length of screws should be determined depending on the thickness of panel. Refer to the outline drawing at the back of this manual.

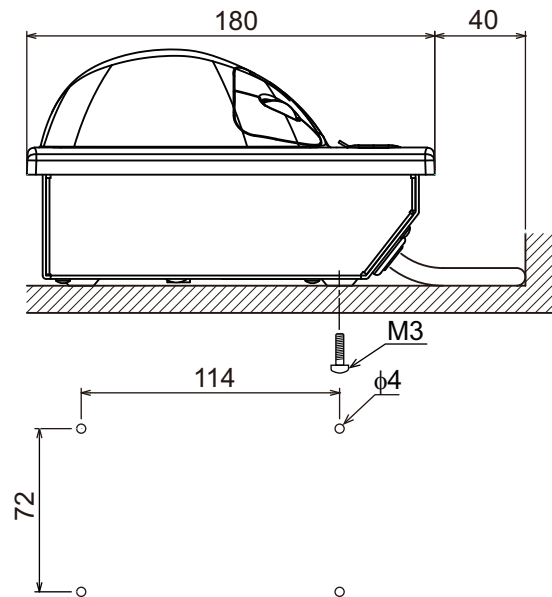

### 1.4.2 How to mount the unit in a console panel

Use the optional flush mount kit OP14-70 to install the unit in a console.

#### Flush mount kit OP14-70

Name	Type	Code No.	QTY	Remark
SEMS B screw	M3 x 8	000-162-649-10	4	
FM1 assy.	OP14-70-1	001-133-860	2	w/ wing bolt/nut
FM2 assy.	OP14-70-2	001-133-870	2	w/ wing bolt/nut
FM1 fixture	14-078-2301-1	100-364-711-10	2	Spare

**Note:** Do not mount the trackball control unit on a inclined surface, as drainage may be prevented.

1. Prepare a cutout in the installation location. Refer to the outline drawing at the back of this manual for the cutout dimensions.
2. Set the unit to the cutout.
3. Attach the mounting plate to the unit with four screws (M3x8, supplied) from rear side.
4. Screw the wing bolts and the wing nuts so that the protectors for the screws move to the flush mount assembly.
5. Fasten each wing bolt and then fasten each wing nut.

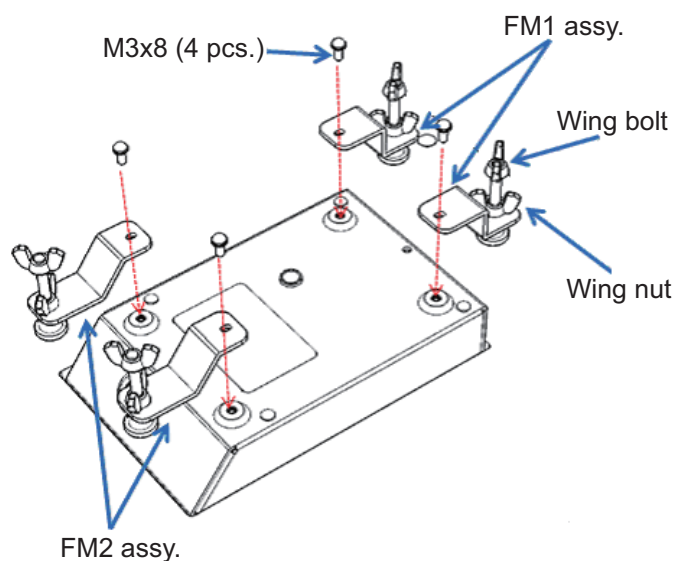



Where there is insufficient space to use the FM2 assembly, use the spare FM1 fixing plates. Use the wing nuts and wing bolts from the unused FM2 assemblies to complete the spare FM1 assemblies.

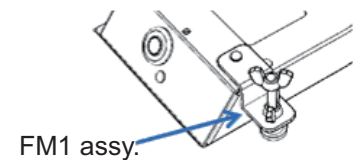

## 1.5 Monitor (Local Supply)

The following FURUNO monitors are available for connection to your FCV-2100: MU-150HD, MU-190 and MU-190HD. Refer to the monitor's manual for installation. You can use an after-market monitor which has specifications as follows:

- Video signal: DVI-D, single link (monitor cable: option)
- Resolution: XGA (1024 x 768, default setting), SXGA (1280 x 1024), Full-HD (1920 x 1080), UXGA (1600 x 1200) or WUXGA (1920 x 1200) are available.

Up to two sub monitor can be connected. The sub monitor resolution should be XGA and video signals are DVI and RGB. A monitor cable for DVI is optional supply, and a monitor cable for RGB should be supplied by the user.

## 1. MOUNTING

This page is intentionally left blank.

# 2. WIRING

## 2.1 Processor Unit

Use the specified cables to connect cables to the processor unit. When the connectors are not used, connector protective caps should be left on the connectors.

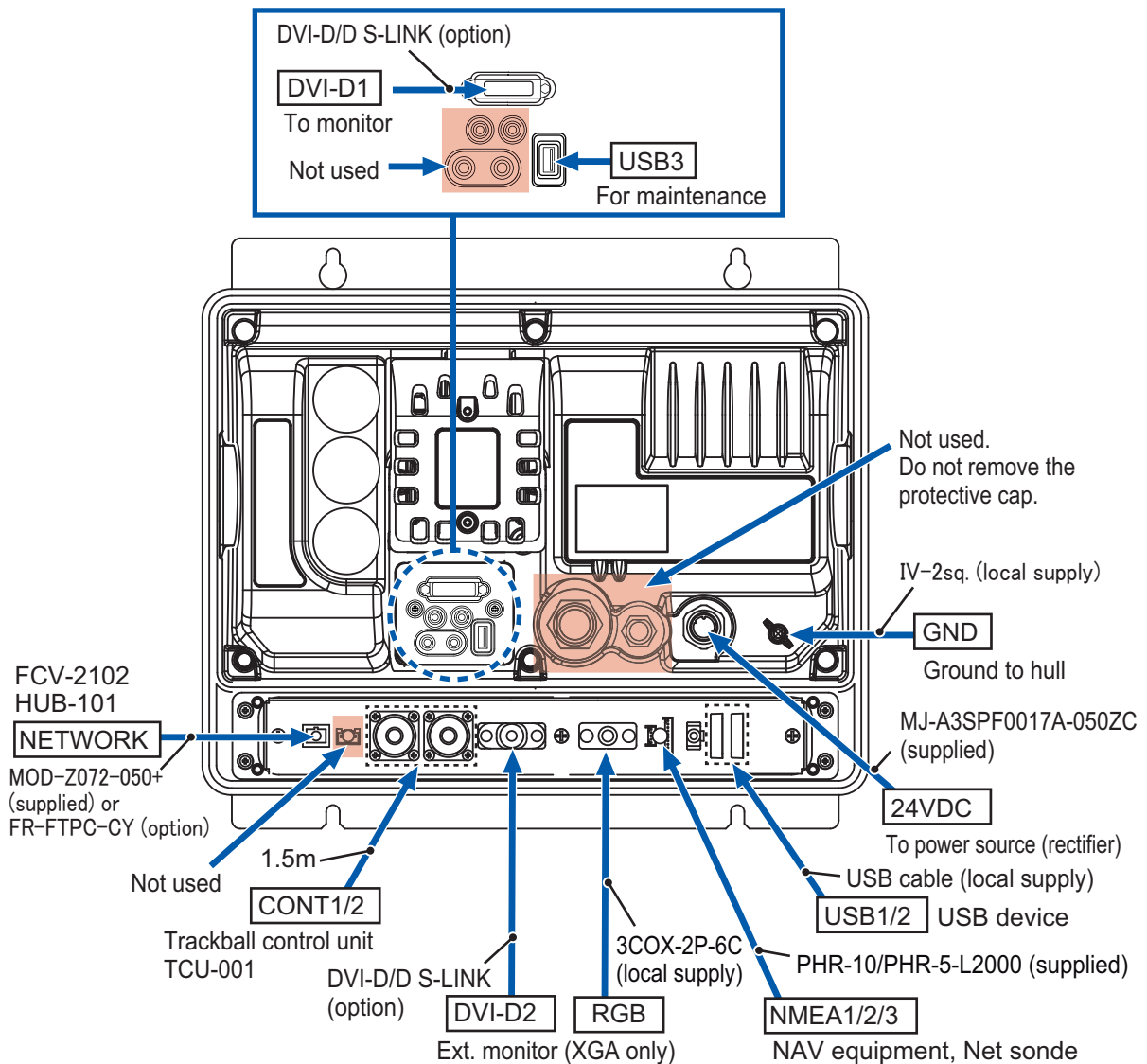

**Note:** Do not connect equipment other than the FCV-2102 or HUB-101 to the NETWORK port.

### 2.1.1 Power cable and grounding

Connect the power cable (MJ-A3SPF0017A-050ZC, 5 m, supplied) to 24VDC power. Connect the ground wire (IV-2sq., local supply) between ground terminal and ship's ground.

### 2.1.2 Control cable, Monitor cable and External connection

The control, monitor and external equipments connection ports are behind the connector cover on the rear panel. Access the ports and connect cables as shown in the procedure on the following page.

**Note:** The processor unit must be mounted indoors to do this connection because of reduction in waterproofing.

1. Disassemble the waterproofing cover.  
The assembled parts are numbered from 1 to 4. These parts should be installed in numerical order, as described in this procedure, or the waterproofing rating is reduced.

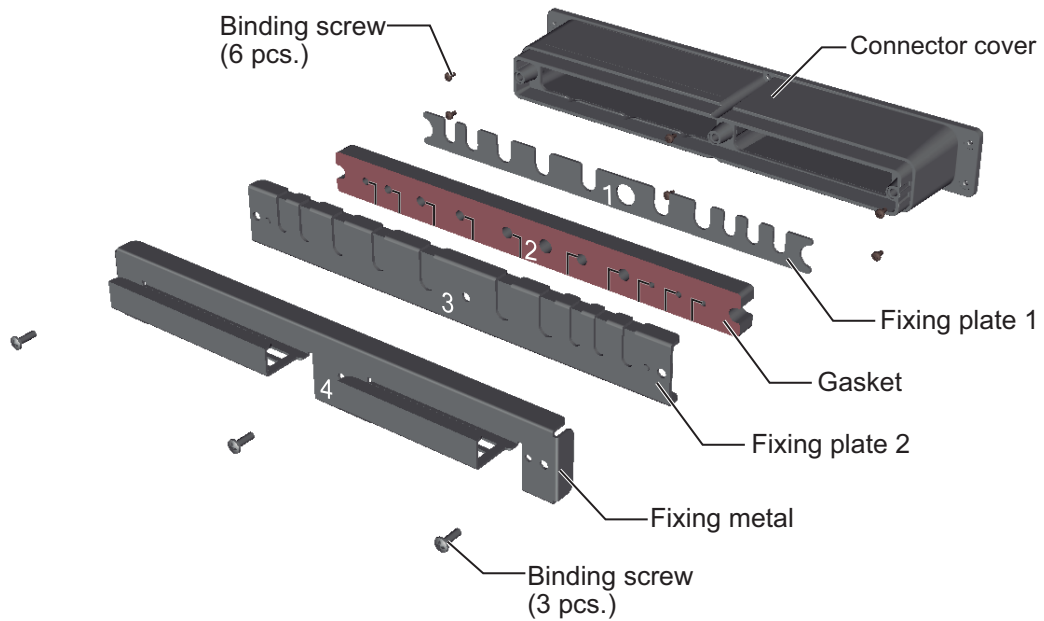

2. Pass the cables through the entrance of connector cover.
3. Connect the cables to the respective ports.
4. Fasten the six binding screws to fix the connector cover.

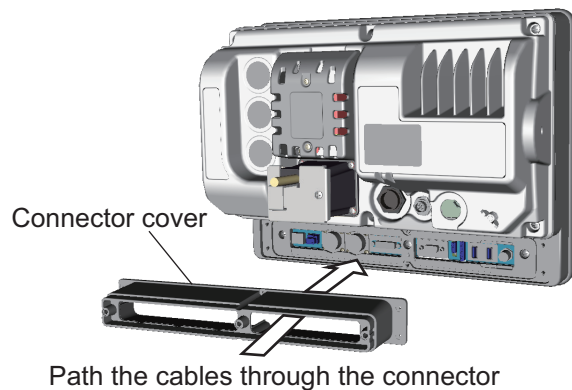

5. Attach the fixing plate 1 to the entrance of the connector cover.  
**Note:** Face the markings outwards.

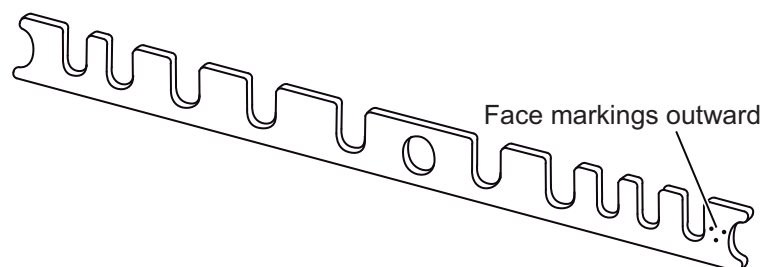

6. Pass the cables through appropriate holes in the gasket.

7. Set the gasket to the entrance of the connector cover.

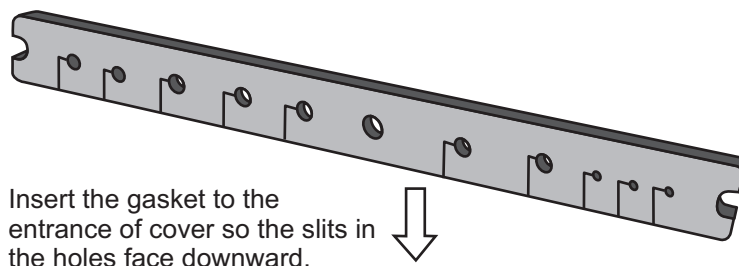

Insert the gasket to the entrance of cover so the slits in the holes face downward.

8. Remove sticker only from the slots to be used on the fixing plate 2.

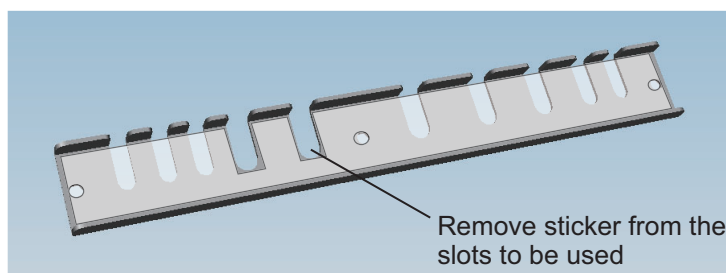

9. Attach the fixing plate 2 to the entrance of the connector cover.  
 10. Fasten the fixing metal to the connector cover with three binding screws.  
 11. Fix the cables to the cable clamp with cable ties (2 pcs. each).

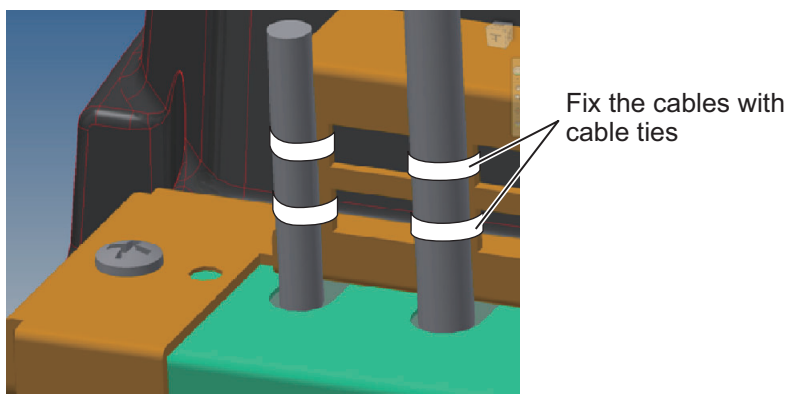

### **Trackball control unit**

Trackball control unit cable (5 m) is connected to CONT1 port or CONT2 port.

### **External monitor (XGA resolution only)**

The FURUNO MU-150HD monitor, or equivalent XGA after-market monitor can be connected as an external monitor. Connect the monitor to the correct port, depending on whether the monitor has analog or digital output.

- Digital (DVI-D2 port): Use the DVI-D/D S-LINK cable (5/10 m, option)
- Analog (RGB port): Use the coax. cable 3COX-2P-6C cable (local supply)

### **NAV equipment**

The NMEA1/2/3 ports are available to connect the navigational equipment. CIF signals are also available from menu setting. Use the supplied cable PHR-10/PHR-5-L2000 (2m) for connecting.

The default settings of ports as follows

## 2. WIRING

- NMEA1/2 port: For NMEA (NMEA Ver 1.5, 4800 bps)
- NMEA3: For CIF (4800 bps)

### **USB device**

The USB1/2 ports are available to connect the USB device, such as a USB flash memory. In order to maintain waterproof rating, this USB ports should be attached at all times. The USB3 port is used for maintenance only.

### **2.1.3 Main monitor**

The following FURUNO monitors are available for connection to your FCV-2100: MU-150HD, MU-190 and MU-190HD. You can use an after-market monitor also. The after-market monitor should have following display resolutions: XGA, SXGA, Full HD or UXGA or WUXGA.

In order to maintain waterproofing, use a DVI-D/D S-LINK cable to connect the main monitor to the DVI-D1 port.

**Note:** The processor unit must be mounted indoors to do this connection because of reduction in waterproofing.

1. Attach a spacer tube to the DVI cable.  
Open the slit on the spacer tube and set the tube to the DVI cable directly behind the connector. Secure the spacer tube in place with cable ties (supplied).

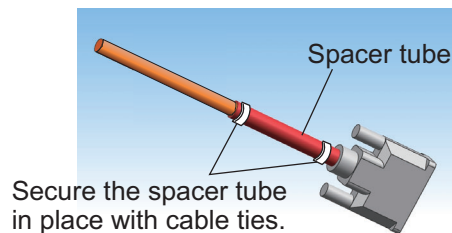

2. Disassemble the boot cover.  
The assembled parts are numbered from 1 to 3. To maintain waterproofing, be sure the parts are re-assembled in numerical order.

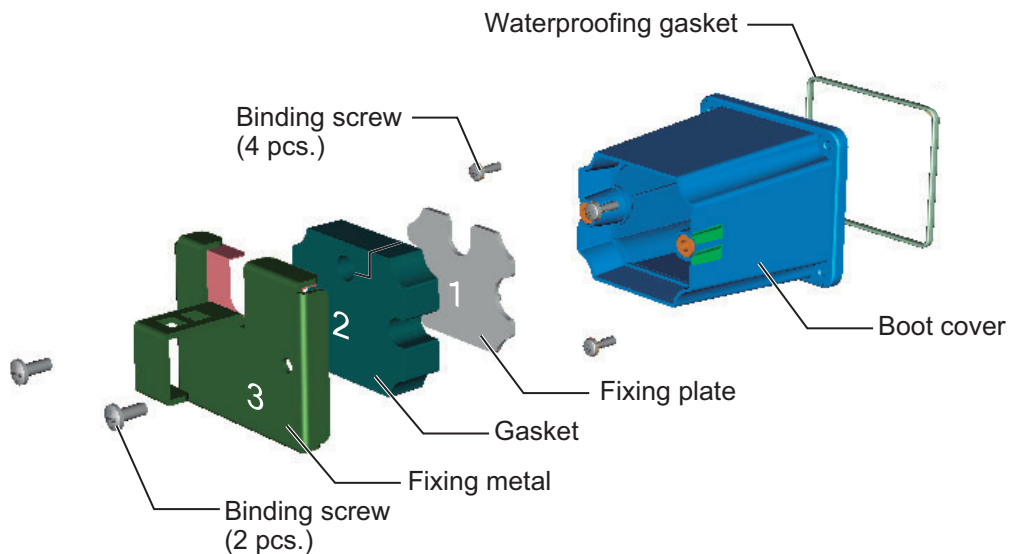

3. Attach the waterproofing gasket to the boot cover, and then pass the DVI-D/D S-LINK cable through the boot cover.

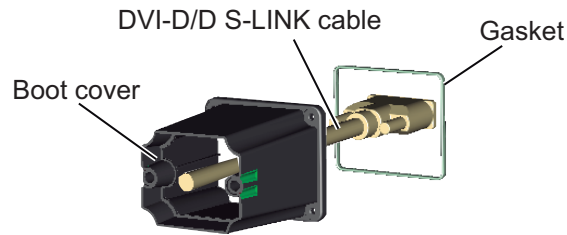

4. Attach the DVI-D/D S-LINK cable connector plug to the DVI-D1 port.
5. Fasten the four binding screws to fix the boot cover.

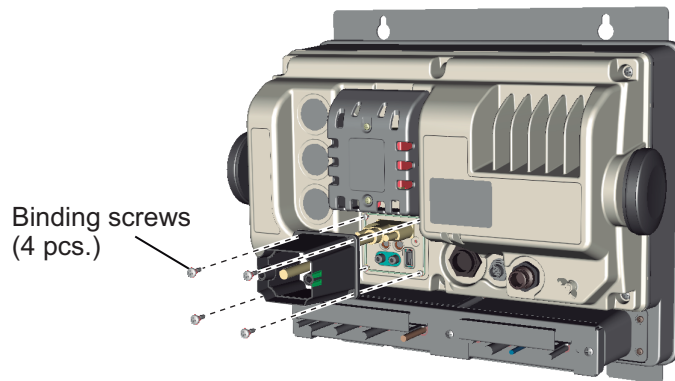

6. Set the fixing plate to the entrance of boot cover.

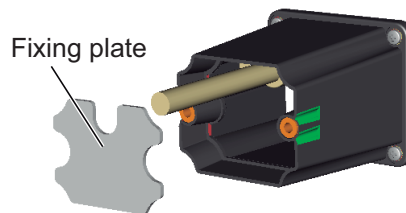

7. Pass the cable through the hole in gasket.  
Be aware of the gasket orientation. The slit must be on the right-hand side.

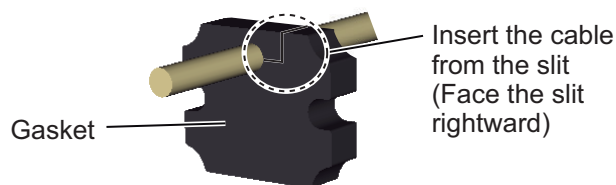

8. Set the gasket to the entrance of the boot cover.

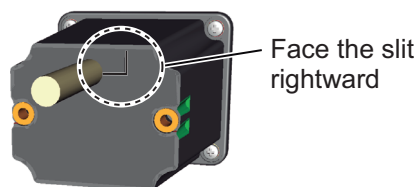

## 2. WIRING

9. Attach the waterproofing sheet to the rear of the cable fixing plate.

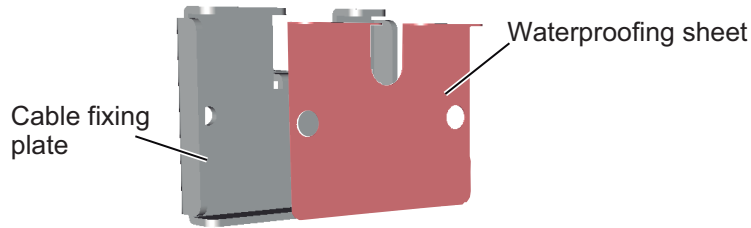

10. Fasten the two binding screws to secure the fixing plate to the boot cover.

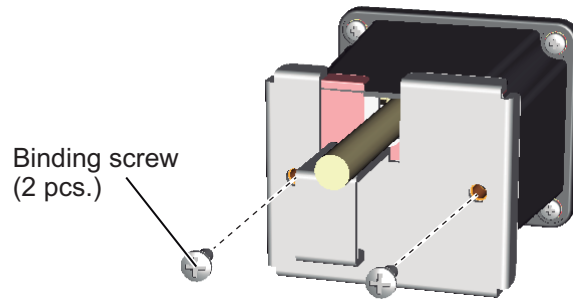

11. Secure the cable to the cable clamp with two cable ties.

**Note:** Cable ties are necessary for waterproofing. Failure to secure cables as outlined in this procedure can cause water ingress.

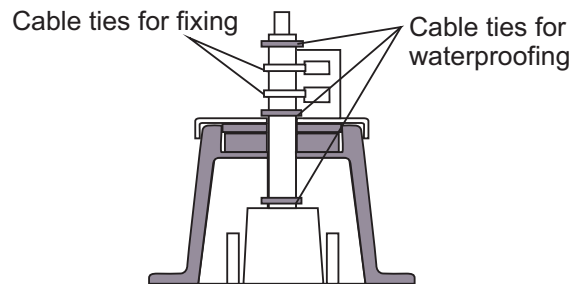

## 2.2 Transceiver Unit

Use the specified cable to connect the transceiver unit to external equipment.

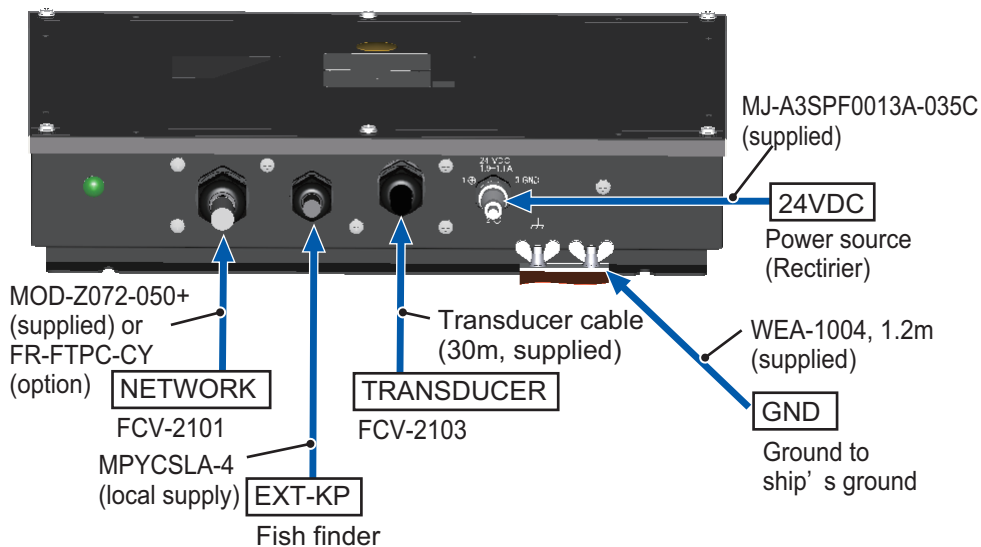



## 2.2.1 Power cable and grounding

Connect the plug of power cable (MJ-A3SPF0013-035C, 3.5m) to the 24VDC port. This unit should be grounded to prevent mutual interference. Connect a copper strap (WEA-1004, 1.2m, supplied) between this unit and the ship's ground. The length of the ground strap should be as short as possible.

## 2.2.2 Transducer cable

**⚠ CAUTION**

**⊘ Do not shorten the transducer cable.**

Shortening the cable may affect the measurement function's accuracy. To extend the distance between the transducer and processor unit, adjust from the LAN cable length between processor unit and transceiver unit.

### Prepare the following for installation

- Cable cutting knife
- Wire cutter
- Cable stripper (AWG25 equivalent)
- Vinyl tape or plastic tube for insulation
- Phillips head screw driver

### How to connect the transducer cable

1. Fabricate the cable end as follows.

**Note:** To avoid interference, do not change the specified length of fabrication.

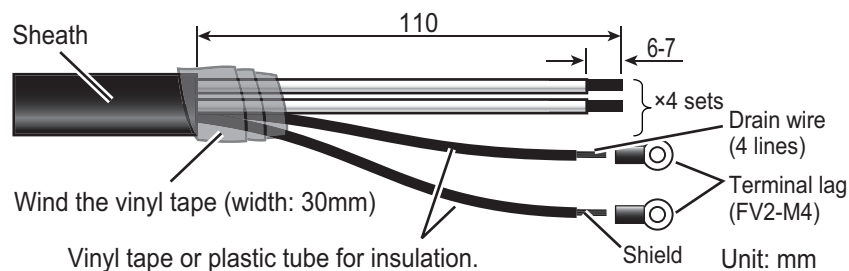

2. Unfasten six screws to remove the cover from the processor unit.

## 2. WIRING

- Unplug the WAGO connector (TB1) from the transducer port shown below.

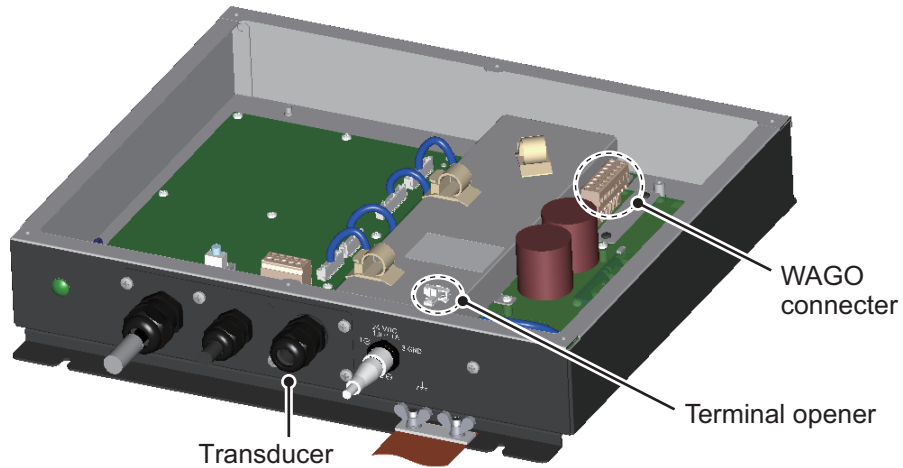

- Unfasten the seal nut from TRANSDUCER port, and then remove the seal.

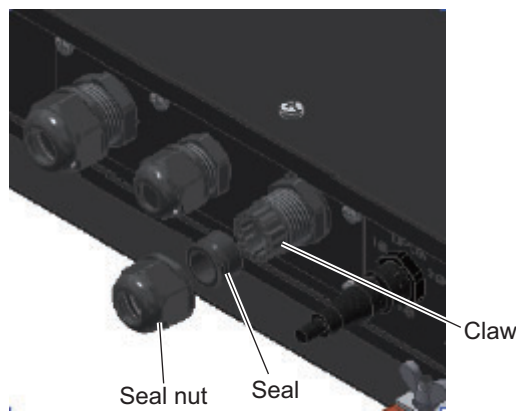

- Run the cable through the seal nut and the seal in order, and then pass the end of cable into the transceiver through the claw and super gland.
- Connect the cores to the WAGO connector plug. The connector opener is attached on the cover. (See figure at step 3)

### How to attach wires to the WAGO connector

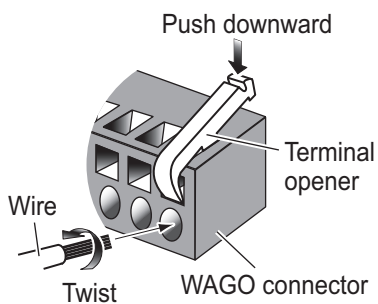

#### Procedure

- Twist cores
- Insert terminal opener and push.
- Insert wire into hole.
- Release terminal opener.
- Pull the wire to confirm that it is secure.

#### Core list

Pin #	Color	Pin #	Color
1	Brown	5	Green
2	Red	6	Blue
3	Orange	7	Purple
4	Yellow	8	Gray

## **CAUTION**



### Connect the cores correctly.

Failure to connect the cores as shown in the table may cause equipment damage or affect equipment functions.

7. Connect the cable to the TB1 connector on the PWRTX board.  
Confirm that the cores from the WAGO connector are not excessively bent.
8. Secure the shield and drain wires to the grounding terminal next to the connector.  
See the figure at step 10 for details.
9. Attach the transducer sticker [FCV-2103 30M] to the transducer cable.  
Refer to section 1.3 for sticker details.
10. Fix the cable to the plate with three cable saddles.

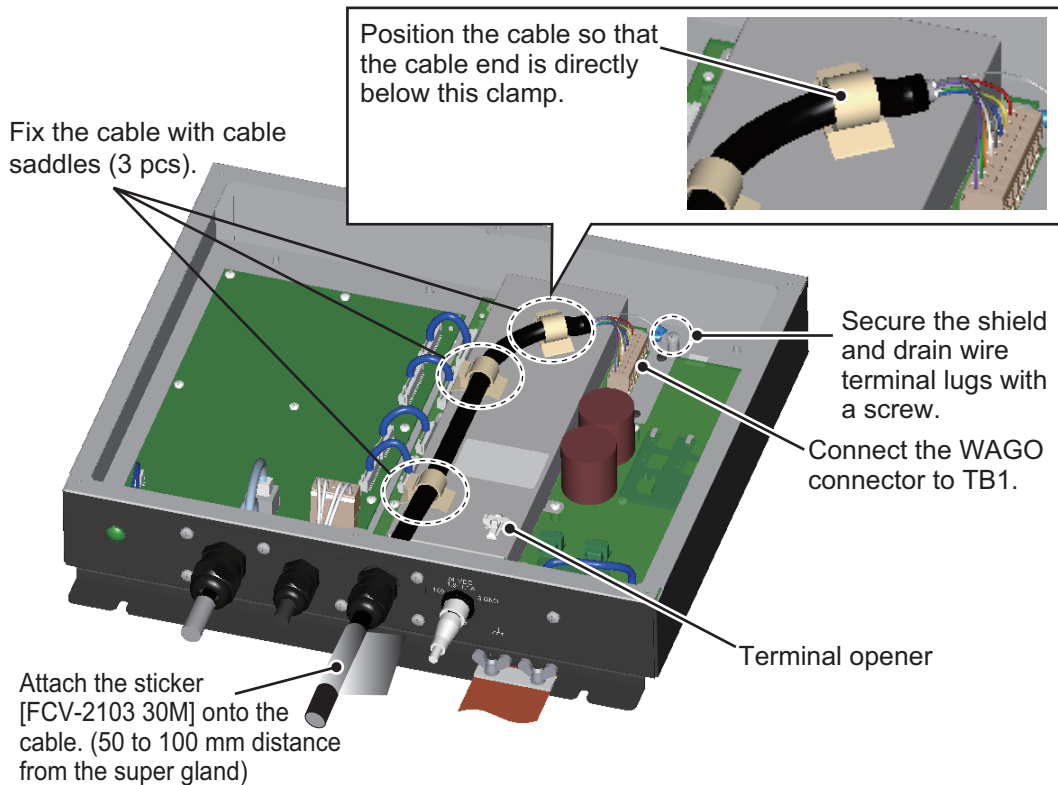

11. Re-assemble the seal assembly, then pack the seal assembly into the gland.
12. Fasten the seal-nut to secure the transducer cable.  
Tighten the seal-nut leaving approx. 6 mm gap between the seal-nut and the super-gland fixing nut.
13. Attach the [Transducer data] sticker on the rear side of transceiver unit cover.

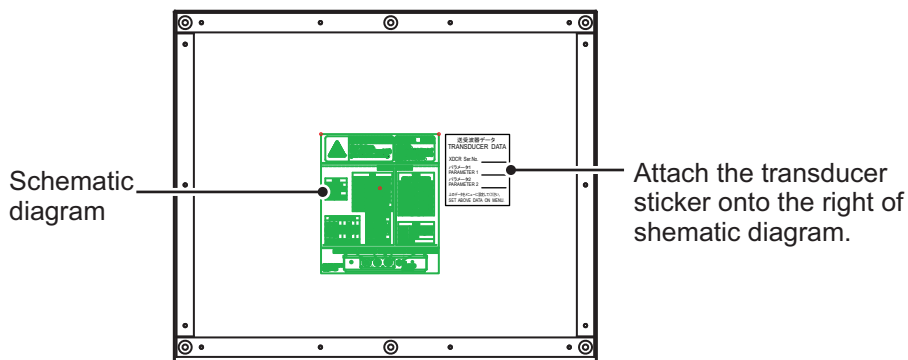
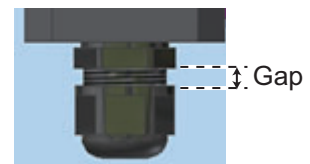

14. Close the cover of the transceiver unit.

### 2.2.3 Processor unit cable (LAN cable)

Connect the processor unit with LAN cable (MOD-Z072-050+, 5m). When using the optional armored cable, peel the external sheath and armor from the cabling. Refer to the following page for armored cable fabrication.

**Note:** Do not connect equipment other than the FCV-2102 or HUB-101 to the NETWORK port.

1. Open the cover of the transceiver unit.
2. Unfasten the seal nut of NETWORK port and disassemble the seal assembly.

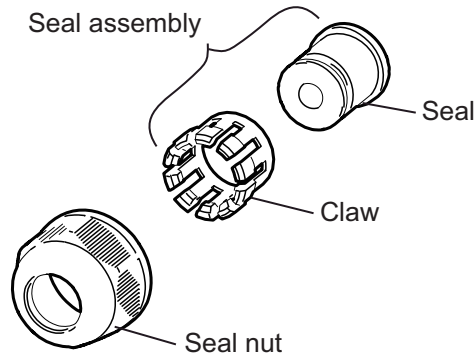

3. Dismantle the seal assembly as shown below.

Dismantling the seal assembly

**STEP 1:** Hold the fat end of the assembly with both thumbs while placing the index fingernails between the seal and claw.

Use caution to avoid injury.

**STEP 2:** Using the thumbs, gently push the seal out of the claw.

The complex block contains two photographs showing hands performing the disassembly steps. The first photo shows the hands holding the seal assembly with index fingernails positioned between the seal and the claw. The second photo shows the hands pushing the seal out of the claw with their thumbs.

4. Pass the cable into the seal nut and seal assembly, then insert the cable into the unit through the cable gland.
5. Set the gasket assembly onto the LAN cable.
6. Pack the gasket assembly into the seal nut.

7. Connect the LAN cable plug to LAN port on the TRX board.  
Make a loop to prevent stress on the connector.

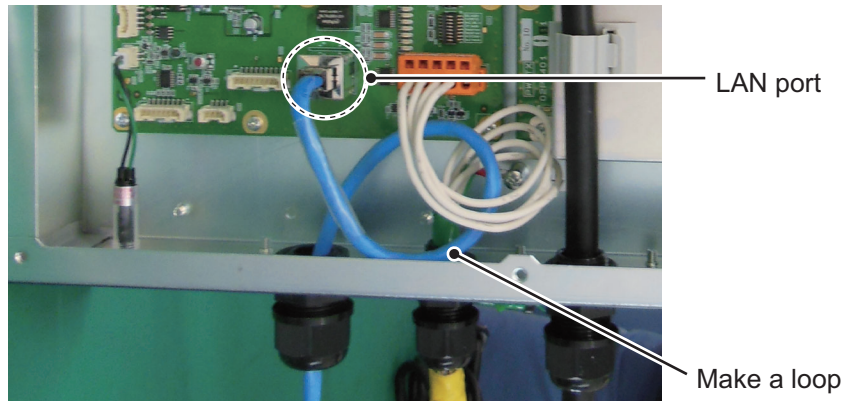

8. Adjust the cable length then fasten the seal nut to fix the cable.  
Tighten the seal nut leaving approx.2 mm gap between the seal nut and super gland fixing nut.
9. Close the cover of the transceiver unit.

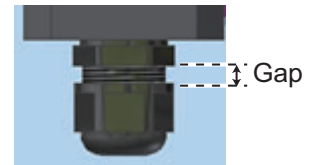

**Fabricating LAN cables**

Fabricate the LAN cables when using the optional armored cable FR-FTPC-CY. Confirm that the shield of the cable touches the case of the modular plug.

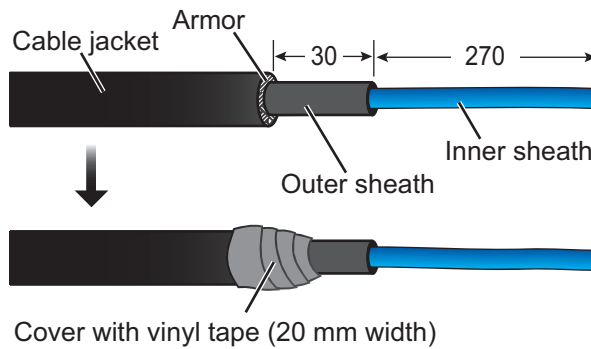

## 2. WIRING



Expose inner vinyl sheath.



Remove the outer sheath by approx 25 mm. Be careful not to damage inner shield and cores.

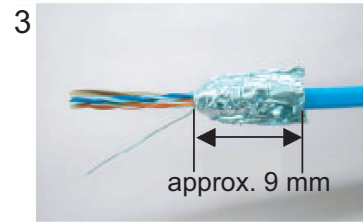

Fold back the shield, wrap it onto the outer sheath and cut it, leaving 9 mm.

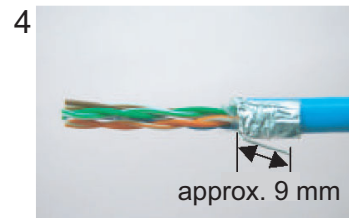

Fold back drain wire and cut it, leaving 9 mm.

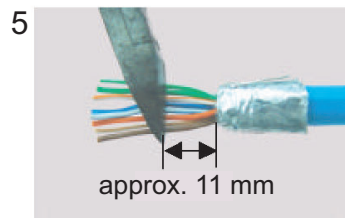

Straighten and flatten the core in order and cut them, leaving 11 mm.



Insert the cable into the modular plug so that the folded part of the shield enters into the plug housing. The drain wire should be located on the tab side of the jack.



Using special crimping tool MPT5-8AS (PANDUIT CORP.), crimp the modular plug. Finally check the plug visually.

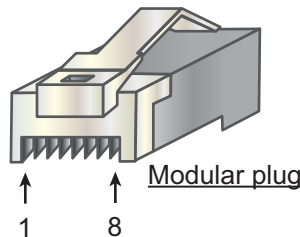

Modular plug

[Cross cable]

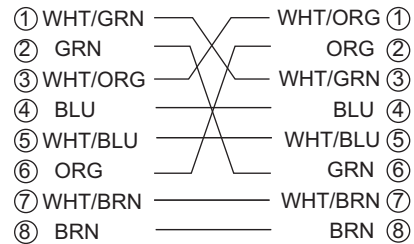

### 2.2.4 Ethernet HUB and USB Device Server

The optional USB device server UDS-001 enables the extension of the trackball control unit cable. The optional HUB-101 Ethernet HUB is required to connect the UDS-001. The Ethernet HUB also allows connection to external network fish finders. Refer to the interconnection diagram at the end of this manual to connect the units.

When connecting the trackball control unit TCU-001, the UDS-001 DIP switches must be returned to the default settings, as follows:

SW No.	Settings (default)
SW1	<p>OFF    ON</p> <p>OFF OFF</p>
SW2	
SW3	

## 2.2.5 External KP control

To control the external KP, connect the external fish finder with a MPYCSLA-4 or equivalent cable (local supply). Refer to the interconnection diagram at end of this manual to connect the cable.

1. Fabricate the cable ends referring to the figure below.

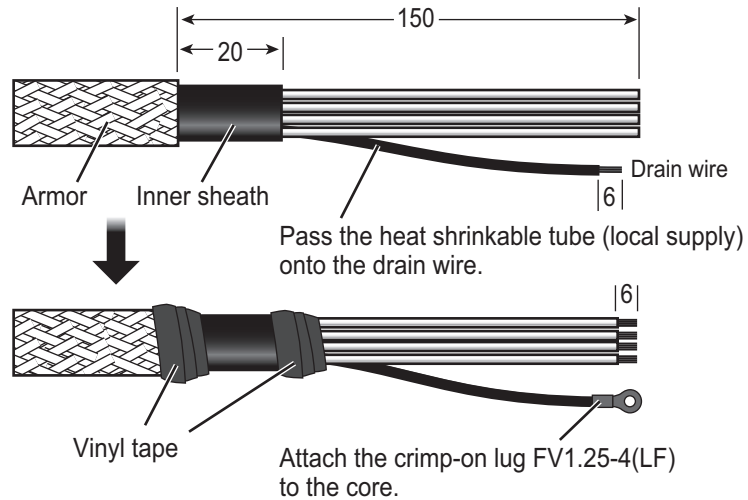

2. Open the cover of the transceiver unit.

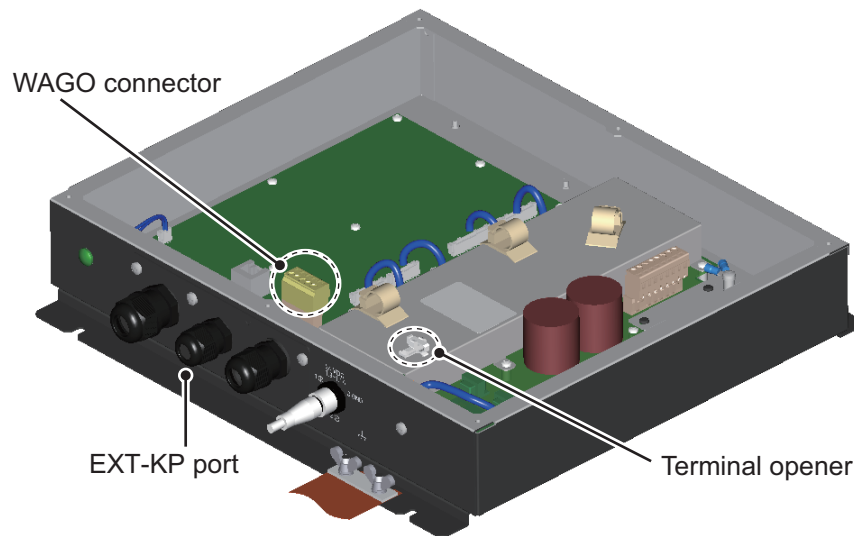

3. Detach the WAGO connector (TB2) from the board.
4. Unfasten the seal nut of EXT-KP port and disassemble the seal assembly. Remove a seal grommet to pass the cable.
5. Pass the cable into the seal nut and seal assembly, then insert the cable into the unit through the cable gland.
6. Connect the cable cores to the WAGO connector referring to the interconnection diagram.

## 2. WIRING

7. Reattach the WAGO connector.  
Fasten the drain wire terminal lug to the chassis with a binding screw.

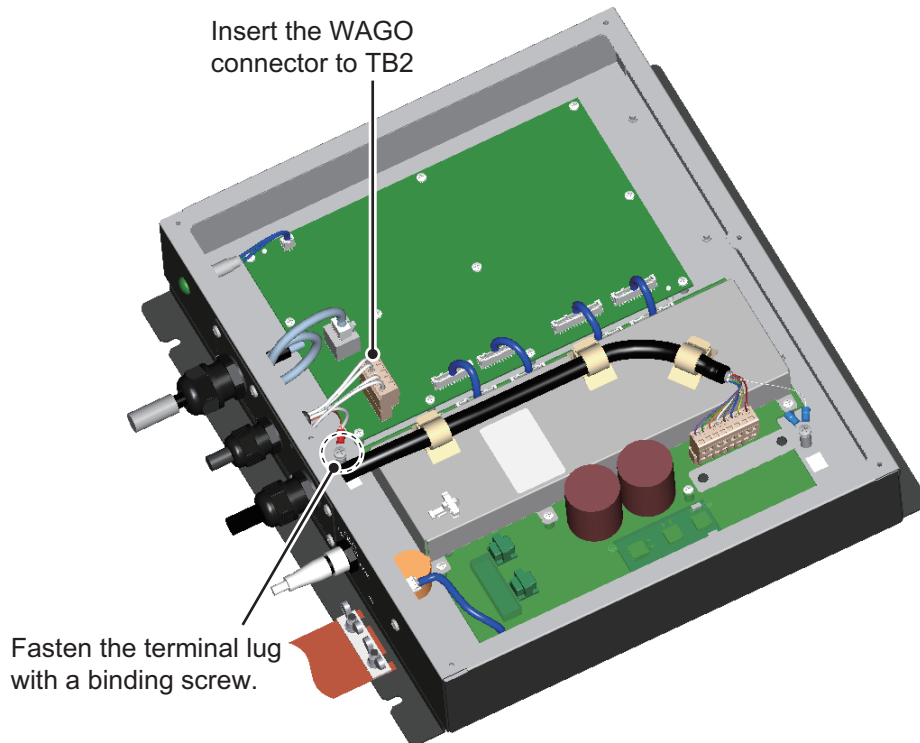

8. Set the gasket assembly and pack them into the seal nut.
9. Adjust the cable length then fasten the seal nut to fix the cable.  
Tighten the seal nut leaving approx. 3 mm gap between the seal nut and super gland fixing nut.
10. Close the cover of the transceiver unit.

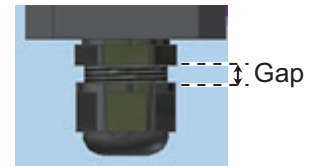

## 2.3 Data Sentences

This equipment can input/output the following NMEA data sentences.

Data	I/O	Sentence
Time, position	Input	GNS>GGA>GLL
Course over the ground (COG) and speed over the ground (SOG)	Input	VTG
Water speed and heading	Input	VHW
Time and date	Input	ZDA
Water depth	Output	DBS, DBT, DPT
Water temperature	Input/Output	MTW
Target position	Output	TLL
Proprietary sentences	Output	SDafl, SDbtm, SDes1, SDes2, SDesd, SDflg, SDmrk, pidat



# 3. INITIAL SETTINGS



This chapter covers the initial setup of the equipment.

## 3.1 How to Set the Language and Measurement Unit



Set the language and measurement unit from the advanced setting menu at installation.

1. Turn the power on.

Open the power button cover on the trackball control unit, then press the power button [  ]. An audible “beep” indicates the equipment is starting up and the start-up screen appears.

2. Show the InstantAccess bar™ by press the [  ] button at left-top when the InstantAccess bar™ is hidden. To hide the InstantAccess bar™, press the [  ] button or right-click of trackball control on anywhere of the screen.



3. Select the [Advanced Settings] icon (  ) from the InstantAccess bar™ to expand the [Advanced Settings] menu bar.
4. Select the [Advanced Settings] icon (  ) from the Menu bar. The [Advanced Settings] menu window appears.
5. Select the [User Interface Settings] from the menu. The user interface settings appear.

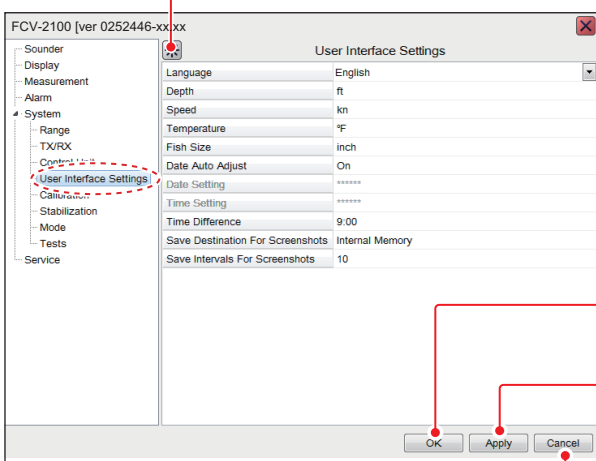

Select this icon to reset the current menu settings to factory default.

Confirm changes and close the menu.

Apply changes. (Menu remains open).

Cancel changes and close the menu.

Setting	Value
Language	English
Depth	ft
Speed	kn
Temperature	°F
Fish Size	inch
Date Auto Adjust	On
Date Setting	*****
Time Setting	*****
Time Difference	9:00
Save Destination For Screenshots	Internal Memory
Save Intervals For Screenshots	10

### 3. INITIAL SETTINGS

6. Select the appropriate language from the [Language] item. Default setting is “English”.
7. Select the measurement units.

Item	Meaning	Unit
Depth	Water depth	m, ft, fa, HR, pb
Speed	Ship's speed	kn, km/h, sm/h
Temperature	Water temperature	°C, °F
Fish Size	Fish length	cm, inch

**Note:** When you change any unit except speed, the following appears. Press the [OK] button to close the message and restore all related settings to default.

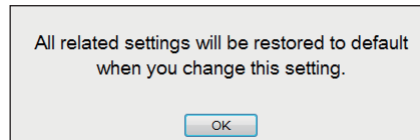



8. Select [OK] to save the current changes and close the menu window.

## 3.2 How to Set the Service Menu

Set the initial parameters for this system from the main monitor.

### 3.2.1 How to Display the Service Menu

1. Select the [Advanced Settings] icon (  ) from the InstantAccess bar™ and select the [Advanced Setting] icon (  ) from the expanded menu bar.
2. Select [Service] to expand the service menu. The message “Ask your dealer to change service settings.” appears.
3. Press and hold the [OK] button to open the service advanced menu.

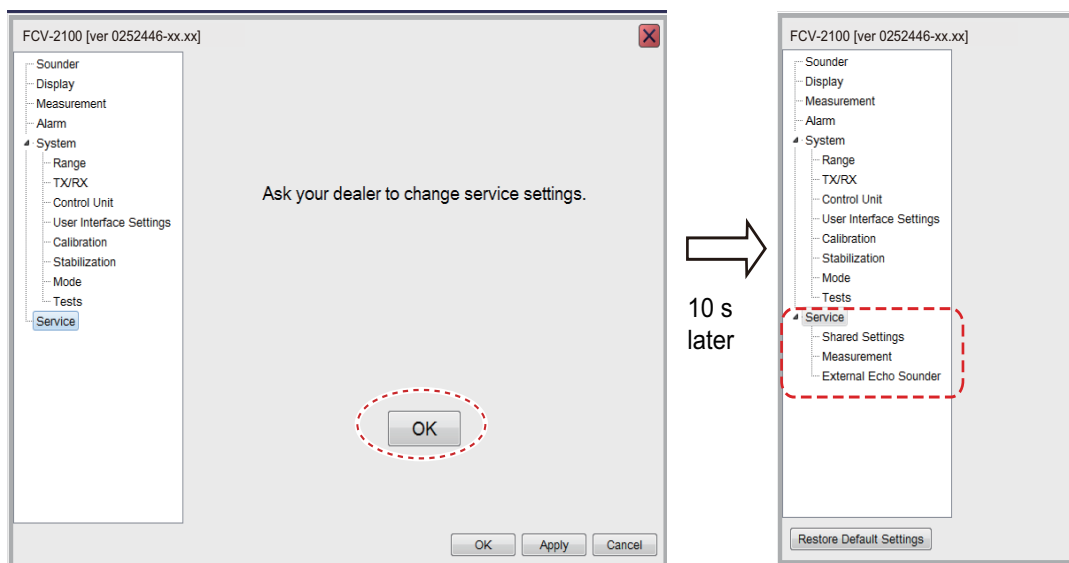

4. Select [Shared Settings] to open the [Shared Settings] menu.

### 3.2.2 Monitor setting

Set the monitors (main/sub) from the service menu.

1. Select [Shared Settings] on the [Service] menu.  
The [Shared Settings] menu appears.

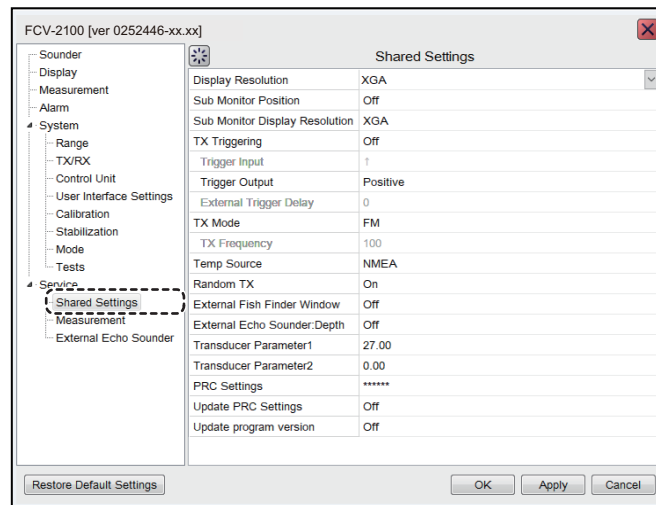

2. Select the display resolution from the [Resolution] menu.  
Selectable resolution: XGA (1024x768, default setting), SXGA (1280x1024), UXGA (1600x1200), Full HD (1920x1080) or WUXGA (1920x1200)  
**Note:** This selection is available for main monitor port (DVI-D1) only. XGA resolution is fixed for monitors connected to sub monitor ports (DVI-D2/RGB).  
For main monitor settings, go to step 6. For sub monitors, go to step 3.
3. Select the sub monitor position (left/right) from the [Sub Monitor Position] menu.
4. Select the sub monitor display resolution from the [Sub Monitor Display Resolution] menu.  
Selectable display resolution: XGA
5. Where an external monitor and an external fish finder are connected, set [External Fish Finder] to [On].  
The message window "Settings will be reset." appears.  
The setting should be left [Off] if no external monitor is connected.

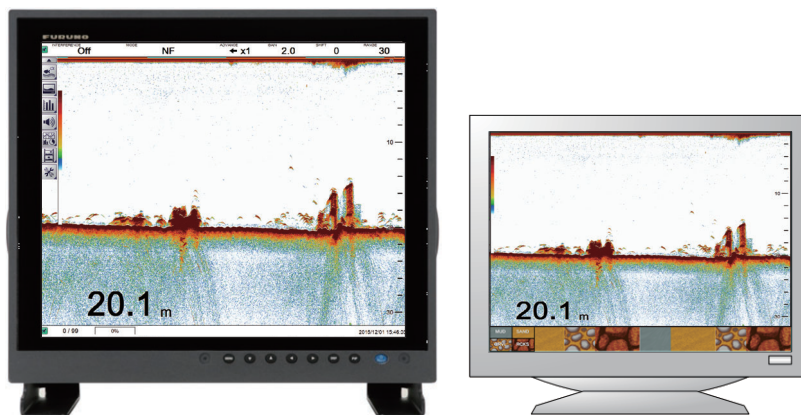



Main monitor: FCV-2100 echo picture    Sub monitor: External fish finder

- [Off]: The echo pictures for this equipment and external sounder are displayed on main monitor.

### 3. INITIAL SETTINGS

- [On]: The echo picture for this equipment is displayed on main monitor and the echo picture for external sounder is displayed on sub monitor. To display the echo picture on the sub monitor, select the [External Echo Sounder] icon

(  ) after selecting the [Display] icon (  ) from the InstantAccess bar™.

6. Set [External Echo Sounder:Depth] to [On] or [Off] as required.  
[On] allows for a possible backup depth reading, in the event that your FCV-2100 cannot find the seabed, provided that the external fish finder can find the seabed. Further, if you set [Depth] as an output for the NMEA data (see section 3.3), the depth from the external sounder is displayed on-screen.
7. Press the [OK] button. The following confirmation screen appears.

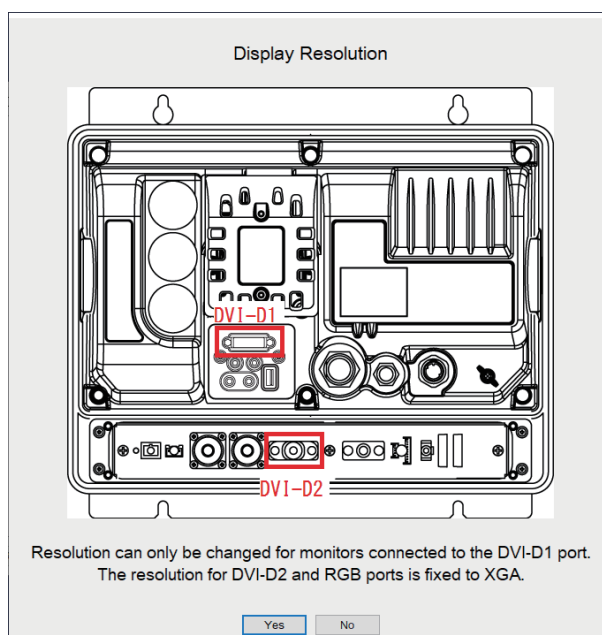

8. Press the [Yes] button to store the setting.  
The message "The change has been stored. Restart the system." appears.
9. Press the [OK] button to reset the system.  
**Note:** The display resolution setting is required when the monitor type is changed.

### 3.2.3 KP control and water temperature setting

Set the KP control signals and water temperature for external equipment and sensor.

1. Select [Shared Settings] on the [Service] menu.
2. Set the [TX triggering] for external KP control.  
TX Triggering: On  
Trigger Input: ↑ (ascent edge) or ↓ (decent edge)  
Trigger Output: Positive or Negative  
External Trigger Display: 0-200 ms (value setting)  
**Note:** External KP levels are follows:
  - Input: 5 V to 12 V
  - Output: 12 V
3. Select [Temp Source] to set the data source for water temperature data.  
Select the temperature sensor data format from NMEA/ CIF/ External E/S Water temperature/ External transducer.

- NMEA: Signal from the connected equipment
  - CIF: Signal from the connected equipment
  - External E/S Water Temperature: Temperature sensor connected to external sounder
  - External Transducer (HF/LF): Temperature sensor in the external sounder's transducer, frequency to use
- Note:** The DFF1-UHD uses a combined transducer. The output data is the same for both HF and LF in this case.

4. Select [OK] to close the menu.

### 3.2.4 Transducer setting



You can increase the accuracy of your fish finder by adjusting transducer parameters. Adjust the parameters as follows:

1. Select the [Shared Settings] on the [Service] menu.
2. Select the [Transducer Parameter1].
3. Input the information as shown on the data sheets included with the transducer. The data sheets are attached to the base of the transducer cable. Do not change the setting for [Transducer Parameter 2] (default: 0.00).
4. Select [OK] to close the menu.

**Note:** The adjustment must be re-done if the transducer is replaced or the unit factory default settings are restored.

## 3.3 Communication Port Setting

You can set the communication port (NMEA1/2/3) from the [Tests] menu. To select the signals for communication, do the following.

1. Select the [Advanced Settings] icon (  ) from the InstantAccess bar™ and select the [Advanced Setting] icon (  ) from the expanded menu bar.
2. Select [Tests] from the [System] menu. The [Tests] menu appears on the right-hand side of the window.

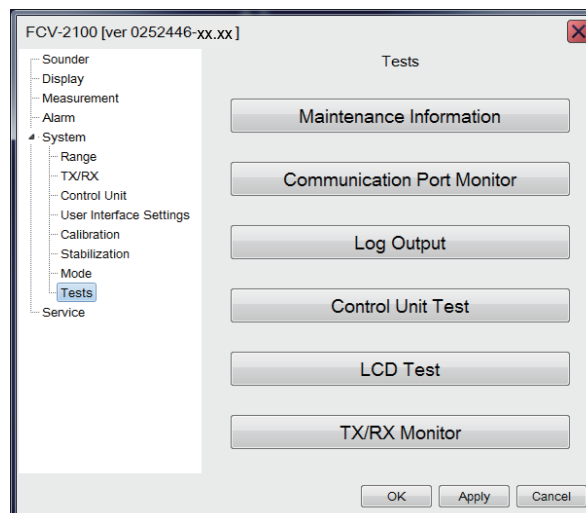

### 3. INITIAL SETTINGS

3. Select the [Communication Port Monitor] from the [Tests] menu.  
The communication port monitor window appears.

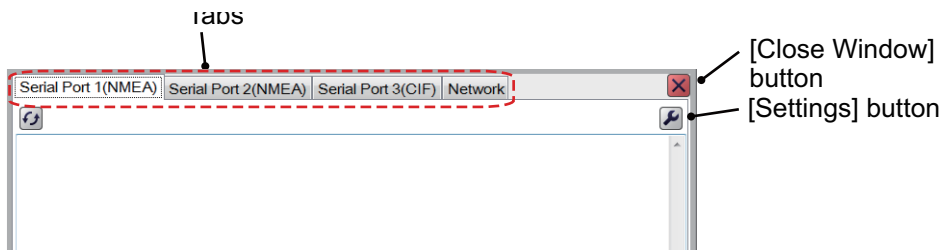

4. Select a port tab to show the corresponding port.
5. Press the [Settings] button (  ) to show the port setting menu. The items circumscribed in the figure below are for research technicians.

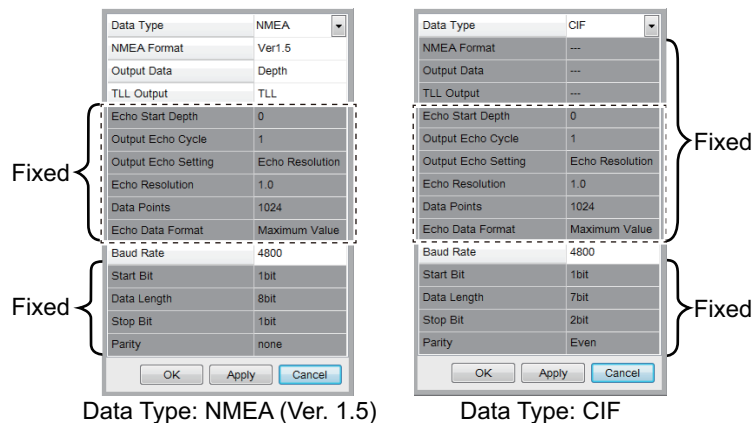

6. Select a data type from the [Data Type] menu depending on connected equipment. (NMEA or CIF)  
The parameter list changes according to the data type selected. For [NMEA] go to step 7; for [CIF] go to step 10.
7. For NMEA data type, select a NMEA format among Ver 1.5, Ver 2.0, Ver 3.0, [Squid-Fishing] or [Echo] (see Note below) as the data format of equipment connected. Select the version according to the input data format of the equipment connected to the NMEA port. If squid fishing is selected, all menu items below [NMEA format] are fixed and not available. Go to step 11.  
**Note:** The [Echo] setting is intended for use by researchers. Do not select the setting unless applicable. The NMEA outputs echo data (baud rate: 38400, 57600 or 115200 bps), however data from the navigation equipment cannot be received.
8. For NMEA data type, select output data from [Depth], [Temperature], [Hardness] or [Fish size]. You can select more than one datum. The fish size function requires the baud rate set to 38400 bps.
9. For NMEA data type, select a TLL output data from [TLL], [FURUNO-TLL] or [Off].
  - [TLL]: Shows L/L data output
  - [FURUNO-TLL]: Shows L/L, water temperature and fish size data output
  - [Off]: Shows no data output**Note:** These output data require appropriate external data input.





## 3.4 External Echo Sounder Setting

To set the external echo sounder, two methods are available: from main monitor or sub monitor. If you have a sub monitor and [External Fish Finder Window] is set to [On], the parameters are set from the sub monitor's menu.

**Note:** When connecting an external echo sounder for the first time, the network sounder settings must be initialized before connection to your FCV-2100. Initialization is done from the network echo sounder's DIP SWITCH settings. For details, see the installation manual for the network sounder.

### 3.4.1 [External Fish Finder Window] setting: Off

The compatible external echo sounders (fish finder) are either a DFF3 or a DFF1-UHD. Set the transducer parameters from the main monitor as follows:

1. Select the [Advanced Settings] icon (  ) from the InstantAccess bar™, and select the [Advanced Settings] icon (  ) from the menu bar. The [Advanced Settings] menu windows appears.
2. Select [Service] to expand the service menu. The message "Ask your dealer to change service settings." appears.
3. Press and hold the [OK] button to open the service advanced menu.
4. Select the "External Echo Sounder" from the [Service] menu.
5. Select the fish finder model from the list. (DFF3/DFF1-UHD) The message appears to reset the settings. Press the [OK] button to close the message.

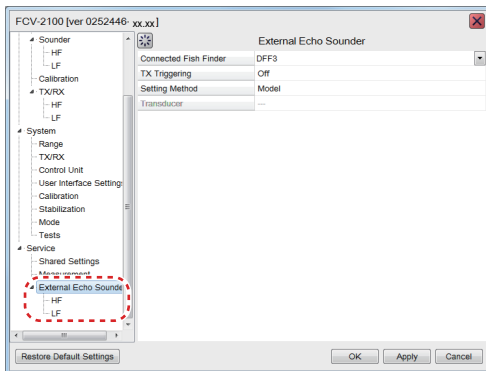

DFF3

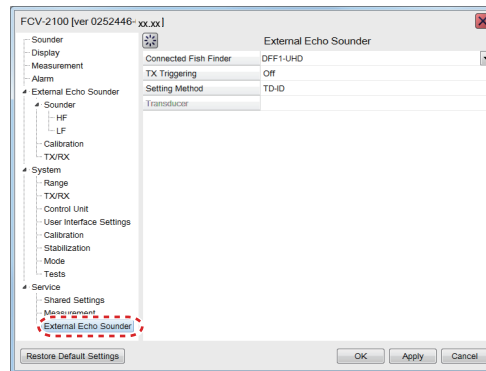

DFF1-UHD

**Note:** The window shown below appears after changing the setting in the above menu. Click the [OK] button to reset.

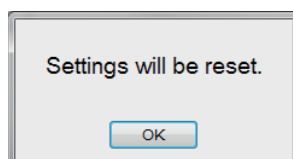



6. Next, do the settings for the network fish finder.

Procedure for DFF3

- 1) Select the [TX Triggering] to [On] to enable the KP control with DFF3.  
**Note:** The main transceiver's TX trigger setting should be 'Off' while this external TX trigger is set 'On'.
- 2) Select the [Setting Method] to [Model] or [Manual] for transducer in use.
  - Model: for FURUNO or Airmar transducers.
  - Manual: for other transducer settings manually.
- 3) Select the [External Echo Sounder] to [HF] (High Frequency) or [LF] (Low Frequency) to set the transducer parameters.

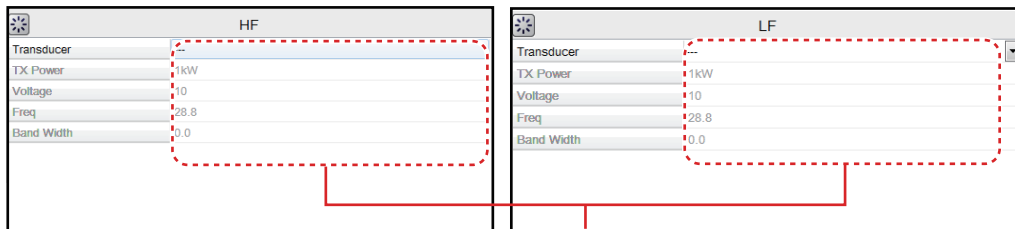

Available when [Setting Method] is [Manual].

[Setting Method] is [Model]

- 4) Select a transducer model from the drop-down menu list when the [Setting Method] is set to [Model].

- 5) If the [Setting Method] is [Manual], do the following:

- 1) Select the output power of the transducer connected to [TX Power], from among 1kW, 2kW, 3kW.
- 2) Select [Voltage], then set TX voltage of the transducer.
- 3) Select [Freq], then set the frequency of the transducer.
- 4) Select [Band Width], then set the band width of the transducer.

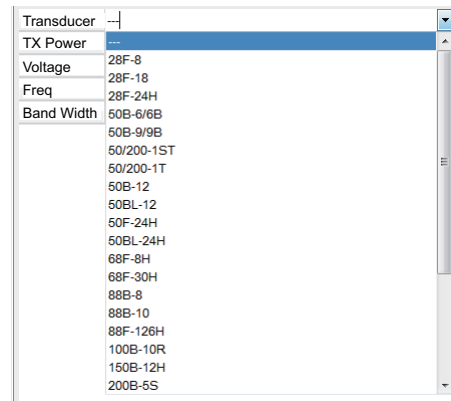

Procedure for DFF1-UHD

- 1) Select the [TX Triggering] to [On] to enable the KP control with DFF1-UHD.  
**Note:** The main transceiver's TX trigger setting should be 'Off' while this external TX trigger is set 'On'.
- 2) Select the [Setting Method] to [Model] or [Manual] for transducer in use.
  - Model: for FURUNO or Airmar transducers.
  - Manual: for other transducer settings manually.
- 3) Select the transducer from the drop down list, from among, B265LH, CM265LH, B275LH-W, CM275LH-W.



### 3. INITIAL SETTINGS

- Click the [OK] button. A window indicates the equipment will restart.  
**Note:** If, for the DFF1-UHD, [Setting Method]=[TD-ID], the TD-ID information is not received, you are informed that the transducer could not be set and to retry setting the transducer. Click the [No] button to restart the equipment.
- Click the [OK] button to restart the equipment.

**Note:** For the DFF3, if this equipment is not powered within one minute and 30 seconds after powering the DFF3, an error message informs you that you should wait for this equipment to connect to the DFF3, which takes approx. seven minutes.

#### 3.4.2 [External Fish Finder Window] setting: On

The external echo sounder (fish finder) settings are available on sub monitor window when the sub monitor is connected. Set the transducer's parameters from sub monitor window as follows. Suppose the sub monitor is installed and the [External Fish Finder Window] is set to [On] already.

- Select the [Windows] icon (  ) from the [InstantAccess] bar™, and press the [Sub monitor] icon (  ) to display the echo window of external fish finder on sub monitor.
- Move the cursor on the sub monitor and right-click to show the [Shared settings] menu for external sounder setting.
- Select [Service] to expand the service menu.  
The message "Ask your dealer to change service settings." appears.
- Press and hold the [OK] button for approximately ten seconds.  
The service advanced menu for external sounder appears.

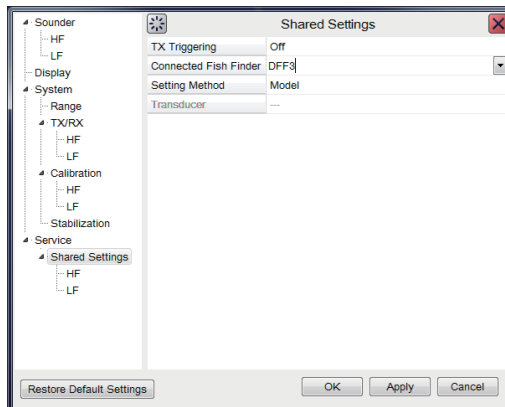



- Select [Shared Settings] to open the [Shared Settings] menu.
- Select [External Fish Finder] to [On] and select fish finder type (DFF3/ DFF1-UHD).  
**Note:** The main transceiver's TX trigger setting should be 'Off' while this external TX trigger is set 'On'.
- Select the transducer type from menu for DFF3, or set the transducer parameters for DFF1-UHD  
Refer to the procedure for paragraph 3.4.1
- Select [OK] to close the menu.

## 3.5 Calibration Setting

The calibration menu allows you to calibrate various settings. You can set the calibration for main system's transducer and external sounder's transducer.

### 3.5.1 Calibration for main system transducer

1. Select the [Advanced Settings] icon (  ) from the InstantAccess bar™ and select the [Advanced Setting] icon (  ) from the expanded menu bar.
2. Select [Calibration] from the [System] menu. The [Calibration] menu appears.

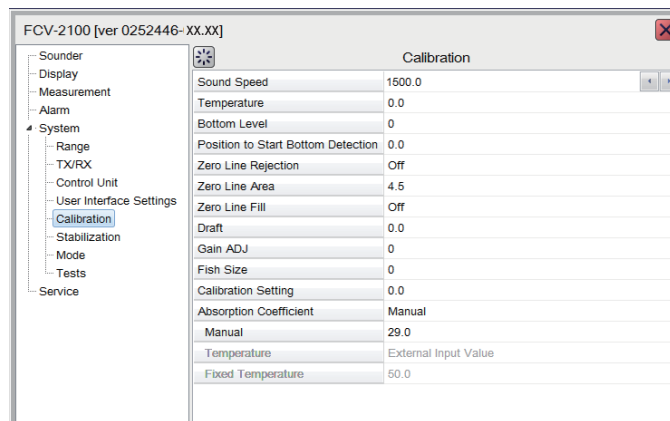

3. Set the calibration parameters referring to the table below:

Item	Meaning	Setting values
Sound speed	Calibration for speed of sound.	200.0 to 2000.0 m/s
Temperature	The water temperature indication is corrected. For example, if the actual temperature is 2°C higher than the temperature displayed on screen, set the offset to [+2°C].	-35.0 to +35.0°F
Bottom level	Set the strength at which an echo is determined to be the bottom. If the level is too low, however, it may be difficult to distinguish bottom fish from the bottom echo.	-40 to +40
Position to start bottom detection	Set the depth threshold at which the sounder detects the seabed.	0.0 to 20.0 m
Zero line rejection	Turn the zero line (transmission line) on or off.	Off/ On
Zero line area	Adjusts the transmission line so that the transmission line disappears when the [Zero Line Rejector] is turned on. For long tail, increase the value. If the transmission line does not disappear, lower the TX power.	1.4 to 3.0 m
Zero line fill	Turn off to see fish echoes within 1 m from the surface.	Off/ On

### 3. INITIAL SETTINGS



Item	Meaning	Setting values																		
Draft	The default depth display shows the distance from the transducer. If you would rather show the distance from the sea surface, set your ship's draft. The draft line for HF and LF can be set respectively.	-9.0 to +30.4 m																		
Gain adjust	If the gain is too high or too low, or the gain for the low and high frequencies appears unbalanced, you can compensate it here.	-50 to +50																		
Fish size	Compensate for incorrect fish size indications. <table border="1" data-bbox="614 616 1050 907"> <thead> <tr> <th>Setting value (%)</th> <th>Adjustment</th> </tr> </thead> <tbody> <tr> <td>-80</td> <td>1/5</td> </tr> <tr> <td>-75</td> <td>1/4</td> </tr> <tr> <td>-65</td> <td>1/3</td> </tr> <tr> <td>-50</td> <td>1/2</td> </tr> <tr> <td>+50</td> <td>x1.5</td> </tr> <tr> <td>+100</td> <td>x2</td> </tr> <tr> <td>+200</td> <td>x3</td> </tr> <tr> <td>+300</td> <td>x4</td> </tr> </tbody> </table>	Setting value (%)	Adjustment	-80	1/5	-75	1/4	-65	1/3	-50	1/2	+50	x1.5	+100	x2	+200	x3	+300	x4	-80 to +300%
Setting value (%)	Adjustment																			
-80	1/5																			
-75	1/4																			
-65	1/3																			
-50	1/2																			
+50	x1.5																			
+100	x2																			
+200	x3																			
+300	x4																			
Calibration settings	Set the target strength (echo strength for individual fish).	-																		
Absorption Coefficient	Choose how to calculate the absorption coefficient. The number is a measure of fish size and hardness (seabed). Used when calculating bottom hardness.	Manual, Auto																		
Manual	Available when [Absorption Coefficient] is set to [Manual]. Set the value to be used for calculating the absorption coefficient.	0.0 to 60.0 (dB)																		
Temperature	Available when [Absorption Coefficient] is set to [Auto]. Select the input source of the water temperature used for automatic calculation of absorption coefficient. <ul style="list-style-type: none"> <li>External input: Use the external water temperature data selected at [Temp Source] in the [Shared Settings] menu.</li> <li>Fixed temperature: Use the temperature set with [Fixed Temperature] (below).</li> </ul>	External Input Value, Fixed Temperature																		
Fixed Temperature	Available when [Absorption Coefficient] is set to [Auto], and [Temperature] is set to [Fixed Temperature]. Set the temperature to be used for automatic calculation of absorption coefficient.	32.0 to 122.0°F																		

4. Select [OK] to close the menu.

### 3.5.2 Calibration for external system transducer

The calibration procedure for external echo sounder is different from the FCV-2100. There are two method, depending on equipment configuration.

**External Echo Sounder mode is 'Off'**

1. Select the [Advanced Settings] icon (  ) from the InstantAccess bar™, and select the [Advanced Setting] icon (  ) from the expanded menu bar.
2. Select [Calibration] from the [Sounder] menu under the [External Echo Sounder] menu list.  
The [Calibration] menu appears.

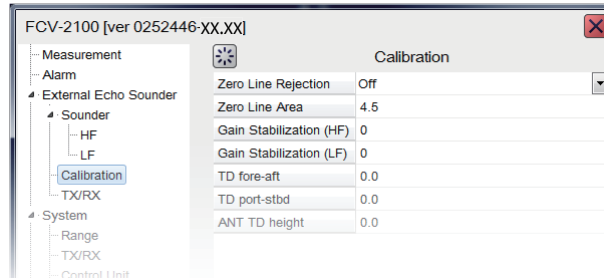

3. Set the calibration parameters from the list.

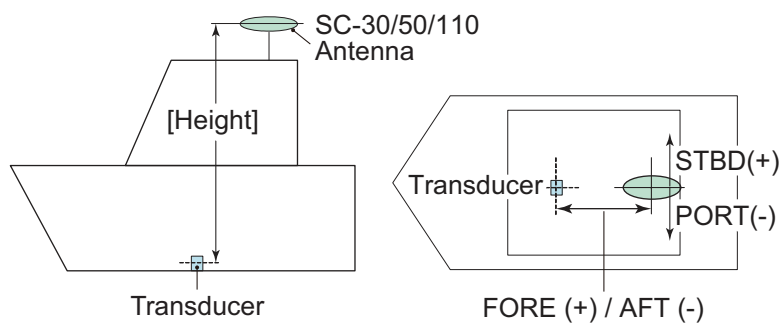

Item	Meaning	Setting values
Zero line rejection	Turn the zero line (transmission line) on or off.	Off/ On
Zero line area	Adjusts the transmission line. Refer to sub-section above.	1.4 to 3.0 m
Gain stabilization (LF/HF)	Set the antenna position for the Satellite Compass™.	-50 to +50
TD fore-aft/port-stbd	Distance (m) from antenna to transducer on the fore-aft/port-stbd line. Enter a positive value for a fore-side transducer.	-100.0 to +100.0 m
ANT TD height	Vertical distance (m) between the antenna and the transducer. Enter a positive value for starboard-side transducer.	0.0 to 100.0 m



4. Select [OK] to close the menu.

### 3. INITIAL SETTINGS

#### **External Echo Sounder mode is 'On'**

1. Select the [Display] icon (  ) from the InstantAccess bar™, and select the [External Sounder] icon (  ) from the expanded menu bar.

The external echo picture is displayed on sub monitor.

2. Move the cursor onto the sub monitor and right-click on the screen.  
The setting menu for external echo sounder appears.
3. Select [Service] of the setting menu and press and hold [OK] for approximately ten seconds.  
The expanded menu appears under the service column.
4. Select the [Calibration] menu from the [System] menu.  
The [Calibration] menu appears.
5. Set the calibration parameters referring to the table below:

Item	Meaning	Setting values														
Zero line rejection	Turn the zero line (transmission line) on or off.	Off/ On														
Zero line area	Adjusts the transmission line.	1.4 to 3.0 m														
Draft	The default depth display shows the distance from the transducer.	-9.0 to +30.4 m														
Fish size	Compensate for incorrect fish size indications. <table border="1" data-bbox="638 1142 1064 1373"> <thead> <tr> <th>Setting value (%)</th> <th>Adjustment</th> </tr> </thead> <tbody> <tr> <td>-80</td> <td>1/5</td> </tr> <tr> <td>-75</td> <td>1/4</td> </tr> <tr> <td>-65</td> <td>1/3</td> </tr> <tr> <td>-50</td> <td>1/2</td> </tr> <tr> <td>+50</td> <td>x1.5</td> </tr> <tr> <td>+100</td> <td>x2</td> </tr> </tbody> </table>	Setting value (%)	Adjustment	-80	1/5	-75	1/4	-65	1/3	-50	1/2	+50	x1.5	+100	x2	-80 to +100%
Setting value (%)	Adjustment															
-80	1/5															
-75	1/4															
-65	1/3															
-50	1/2															
+50	x1.5															
+100	x2															
Sound speed	Calibration for speed of sound.	200.0 to 2000.0 m/s														

6. Set the calibration parameters for bottom level and gain adjust from the [LF/HF] menu under the [Calibration] menu.

Item	Meaning	Setting values
Bottom level	Set the strength at which an echo is determined to be the bottom. Be aware of low level setting may cause misread the bottom staying fish from seabed.	-40 to +40
Gain adjust	If the gain is too high or too low, or the gain for the low and high frequencies appears unbalanced.	-50 to +50

7. Select [OK] to close the menu.

## 3.6 Stabilization Setting



The [Stabilization] menu compensates for the effects of heaving, and requires a Satellite Compass™.

**Note 1:** The menu is not available when there is no data from the Satellite Compass™.

**Note 2:** This function is not available when the “TX Triggering” on the [Shared Settings] menu is ‘On’.

### 3.6.1 Stabilization for main system transducer

Set the stabilization menu for main system and external system transducers when the [External sounder] is set [Off].

1. Select the [Advanced Settings] icon (  ) from the InstantAccess bar™, and select the [Advanced Setting] icon (  ) from the expanded menu bar.
2. Select the [Stabilization] menu from the [System] menu. The [Stabilization] menu appears.

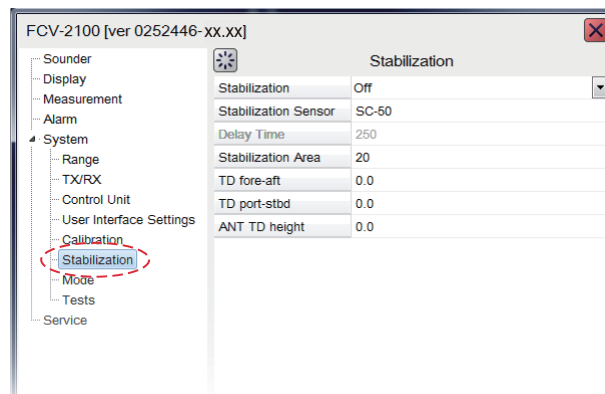

3. Set [Stabilization] to [On] to enable the stabilization mode. Turn this function on when seas are rough, to get stable pictures regardless of sea conditions. When heaving stabilization is turned on, the symbol (  ) appears at the “Advance” header on the screen.
4. Select the model of Satellite Compass™ from the list on menu. When you select other than ‘manual’, go to step 6.
5. Set the delay time between 0 and 1000 ms.
6. Set the antenna position for the Satellite Compass™.

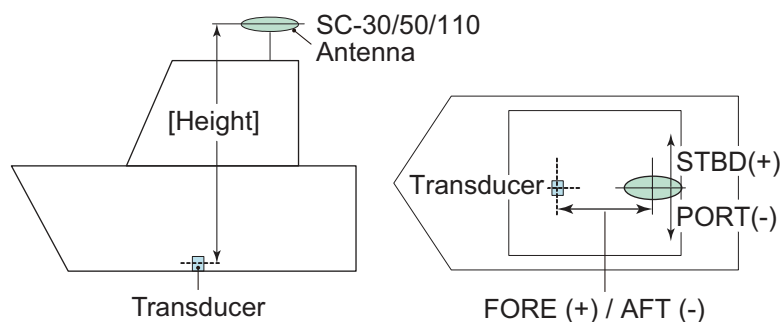

### 3. INITIAL SETTINGS

- TD fore-aft: Distance (m) from antenna to transducer on the fore-aft line. Enter a positive value for a fore-side transducer, a negative value for an aft-side transducer. (-100.0 to +100.0m)
- TD port-stbd: Distance (m) from antenna to transducer on the port-stbd line. Enter a positive value for starboard-side transducer, a negative value for a port-side transducer. (-100.0 to +100.0m)
- ANT TD height: Vertical distance (m) between the antenna and the transducer. (0.0m to 110.0m)

7. Select the [OK] to close the menu.

**Note:** For the heaving feature, set the SC-30/50/110 Satellite Compass™ output as follows. Refer to respective operator’s manual for setting details.

Feature	SC-50/110 (Data out setting)	SC-30 (IF-NMEASC setting)
Sentence	ATT, HVE	ATT, HVE
Baud rate	38400 bps	38400 bps
Cycle	25 ms	25 ms
Format	IEC Ed.1	-

#### 3.6.2 Stabilization for external sounder transducer

Set the stabilization menu for external system transducers when the [External sounder] is set [On].

1. Move the cursor onto the sub monitor and right-click on the screen  
The setting menu for external sounder appears.
2. Select [Stabilization] from the list on menu.  
The [Stabilization] menu appears.

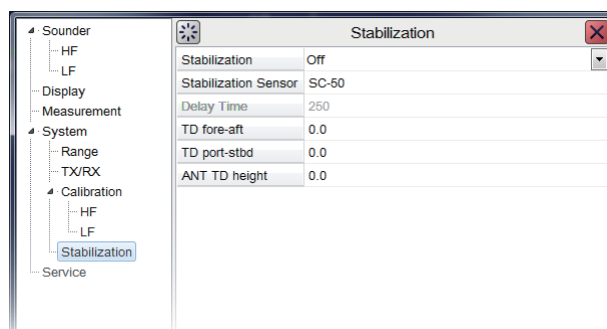

3. Set the stabilization parameters refer to step 3 to 7 of subsection above.



## 3.7 Reset to Default Setting

To reset all customized settings for advanced setting menus and external sounder setting menus to their default settings. The external echo sounder setting should be reset before the reset of main system setting. Do the following procedure.

**Note:** Customized settings cannot be restored. If necessary jot down the settings.

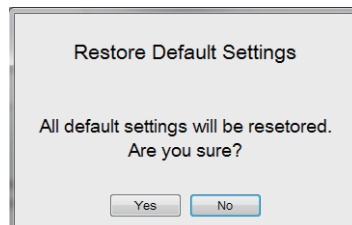

### **Reset the external sounder settings**

1. Move the cursor to the external echo picture on sub monitor, and right-click on the screen.
2. Select [Service] from the menu, then press and hold the [OK] button for approximately ten seconds.  
The [Shared Settings] menu appears.
3. Select [Restore Default Settings] at the left bottom corner of the window.  
The message window appears as below.



4. Select [Yes] to restart the system.

### **Reset the advanced settings for main system**

1. Select the [Advanced Settings] icon (  ) from the InstantAccess bar™, and select the [Advanced Settings] icon (  ) from the expanded menu bar.
2. Select [Service] from the menu and press and hold the [OK] button for approximately ten seconds.  
The [Shared Settings] menu appears.
3. Select [Restore Default Settings] at the left bottom corner of the window.  
The message window appears same as above.
4. Select [Yes] to restart the system.

### 3. INITIAL SETTINGS

This page is intentionally left blank.

# APPENDIX 1 JIS CABLE GUIDE

Cables listed in the manual are usually shown as Japanese Industrial Standard (JIS). Use the following guide to locate an equivalent cable locally.

JIS cable names may have up to 6 alphabetical characters, followed by a dash and a numerical value (example: DPYC-2.5).

For core types D and T, the numerical designation indicates the *cross-sectional Area (mm<sup>2</sup>)* of the core wire(s) in the cable.

For core types M and TT, the numerical designation indicates the *number of core wires* in the cable.

## 1. Core Type

- D: Double core power line
- T: Triple core power line
- M: Multi core
- TT: Twisted pair communications  
(1Q=quad cable)

## 2. Insulation Type

- P: Ethylene Propylene Rubber

## 3. Sheath Type

- Y: PVC (Vinyl)

## 4. Armor Type

- C: Steel

## 5. Sheath Type

- Y: Anticorrosive vinyl sheath

## 6. Shielding Type

- S: All cores in one sheath
- S: Individually sheathed cores
- SLA: All cores in one shield, plastic tape w/aluminum tape
- SLA: Individually shielded cores, plastic tape w/aluminum tape



DPYCY



TPYCY

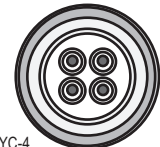

MPYC-4

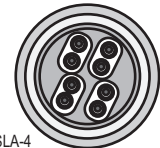

TTYCSLA-4

EX: <sup>1 2 3 4 5 6</sup> **TTYCYSLA - 4**  
 Designation type | # of twisted pairs







EX: <sup>1 2 3 4</sup> **MPYC - 4**  
 Designation type | # of cores

The following reference table lists gives the measurements of JIS cables commonly used with Furuno products:

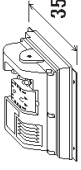
Type	Core		Cable Diameter	Type	Core		Cable Diameter
	Area	Diameter			Area	Diameter	
DPYC-1.5	1.5mm <sup>2</sup>	1.56mm	11.7mm	TTYCS-1	0.75mm <sup>2</sup>	1.11mm	10.1mm
DPYC-2.5	2.5mm <sup>2</sup>	2.01mm	12.8mm	TTYCS-1T	0.75mm <sup>2</sup>	1.11mm	10.6mm
DPYC-4	4.0mm <sup>2</sup>	2.55mm	13.9mm	TTYCS-1Q	0.75mm <sup>2</sup>	1.11mm	11.3mm
DPYC-6	6.0mm <sup>2</sup>	3.12mm	15.2mm	TTYCS-4	0.75mm <sup>2</sup>	1.11mm	16.3mm
DPYC-10	10.0mm <sup>2</sup>	4.05mm	17.1mm	TTYCSLA-1	0.75mm <sup>2</sup>	1.11mm	9.4mm
DPYCY-1.5	1.5mm <sup>2</sup>	1.56mm	13.7mm	TTYCSLA-1T	0.75mm <sup>2</sup>	1.11mm	10.1mm
DPYCY-2.5	2.5mm <sup>2</sup>	2.01mm	14.8mm	TTYCSLA-1Q	0.75mm <sup>2</sup>	1.11mm	10.8mm
DPYCY-4	4.0mm <sup>2</sup>	2.55mm	15.9mm	TTYCSLA-4	0.75mm <sup>2</sup>	1.11mm	15.7mm
MPYC-2	1.0mm <sup>2</sup>	1.29mm	10.0mm	TTYCY-1	0.75mm <sup>2</sup>	1.11mm	11.0mm
MPYC-4	1.0mm <sup>2</sup>	1.29mm	11.2mm	TTYCY-1T	0.75mm <sup>2</sup>	1.11mm	11.7mm
MPYC-7	1.0mm <sup>2</sup>	1.29mm	13.2mm	TTYCY-1Q	0.75mm <sup>2</sup>	1.11mm	12.6mm
MPYC-12	1.0mm <sup>2</sup>	1.29mm	16.8mm	TTYCY-4	0.75mm <sup>2</sup>	1.11mm	17.7mm
TPYC-1.5	1.5mm <sup>2</sup>	1.56mm	12.5mm	TTYCY-4S	0.75mm <sup>2</sup>	1.11mm	21.1mm
TPYC-2.5	2.5mm <sup>2</sup>	2.01mm	13.5mm	TTYCY-4SLA	0.75mm <sup>2</sup>	1.11mm	19.5mm
TPYC-4	4.0mm <sup>2</sup>	2.55mm	14.7mm	TTYCYS-1	0.75mm <sup>2</sup>	1.11mm	12.1mm
TPYCY-1.5	1.5mm <sup>2</sup>	1.56mm	14.5mm	TTYCYS-4	0.75mm <sup>2</sup>	1.11mm	18.5mm
TPYCY-2.5	2.5mm <sup>2</sup>	2.01mm	15.5mm	TTYCYSLA-1	0.75mm <sup>2</sup>	1.11mm	11.2mm
TPYCY-4	4.0mm <sup>2</sup>	2.55mm	16.9mm	TTYCYSLA-4	0.75mm <sup>2</sup>	1.11mm	17.9mm

PACKING LIST  
FCV-2101-J/E

026S-X-9851 -2 1/1  
A-1

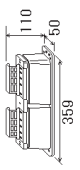
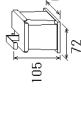
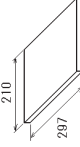
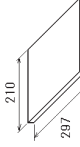
NAME	OUTLINE	DESCRIPTION/CODE No.	Q'TY
<b>ユニット</b>			
制御部 PROCESSOR UNIT		FCV-2101-* 000-029-449-00 **	1
<b>予備品</b>			
予備品 SPARE PARTS		SP14-03601 001-246-900-00	1
<b>付属品</b>			
付属品 ACCESSORIES		FP19-01801 001-205-650-00	1
<b>工事材料</b>			
<b>INSTALLATION MATERIALS</b>			
ケーブル(組品)M CABLE ASSEMBLY		MJ-A3SPF0017A-050ZC 000-178-421-10	1
コネクタ(組品) CONNECTOR ASSEMBLY		PHR-10/PHR-5-L2000 001-248-530-00	1
工事材料 INSTALLATION MATERIALS		CP02-09001 001-248-550-00	1
防水カバー-A組品 WATERPROOF COVER A ASSEMBLY		CP02-09002 001-259-930-00	1
防水カバー-B組品 WATERPROOF COVER B ASSEMBLY		CP02-09003 001-275-530-00	1
<b>図書</b>			
<b>DOCUMENT</b>			
取扱説明書 OPERATOR'S MANUAL		011*-23910-* 000-191-380-1* **	1
整備要領書 INSTALLATION MANUAL		111*-23910-* 000-191-382-1* **	1





コード番号末尾の[\*]は、選択品の代表コードを表します。  
CODE NUMBER ENDING WITH "\*" INDICATES THE CODE NUMBER OF REPRESENTATIVE MATERIAL.

(略図の寸法は、参考値です。DIMENSIONS IN DRAWING FOR REFERENCE ONLY.)

C2391-Z01-C

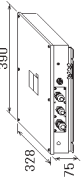
PACKING LIST  
FCV-2102

026S-X-9852 -2 1/1  
A-2

NAME	OUTLINE	DESCRIPTION/CODE No.	Q'TY
<b>ユニット</b>			
送受信部 TRANSCIEVER UNIT		FCV-2102-* 000-029-453-00 **	1
<b>予備品</b>			
予備品 SPARE PARTS		SP24-00301 001-041-310-00	1
<b>工事材料</b>			
<b>INSTALLATION MATERIALS</b>			
ケーブル(組品)M CABLE ASSEMBLY		MJ-A3SPF0013A-035C 000-176-666-10	1
ケーブル(組品)LAN LAN CABLE ASSEMBLY		MOD-Z072-050+ 001-167-890-10	1
工事材料 INSTALLATION MATERIALS		CP02-09301 001-436-230-00	1

コード番号末尾の[\*]は、選択品の代表コードを表します。  
CODE NUMBER ENDING WITH "\*" INDICATES THE CODE NUMBER OF REPRESENTATIVE MATERIAL.

(略図の寸法は、参考値です。DIMENSIONS IN DRAWING FOR REFERENCE ONLY.)

C2391-Z02-C

# PACKING LIST

FCV-2103

026S-X-9853 -0 1/1

A-3

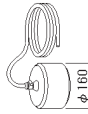
NAME	UNIT	OUTLINE	DESCRIPTION/ CODE No.	Q'TY
ユニット 送受波器 TRANSDUCER		 φ160	FCV-2103 000-029-456-00	1

(略図の寸法は、参考値です。 DIMENSIONS IN DRAWING FOR REFERENCE ONLY.)

C2391-Z03-A





A-4

# FURUNO

CODE NO.	001-248-550-00	02GN-X-9401-1
TYPE	CP02-09001	1/1

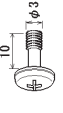
## 工事材料表

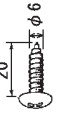
### INSTALLATION MATERIALS

番号	名称	略図	型名/規格	数量	用途/備考
NO.	NAME	OUTLINE	DESCRIPTIONS	Q'TY	REMARKS
1	シーリング付ボルト SHOULDER SCREW WITH SEAL W	 10 φ3	19-631-4017-0 CODE NO. 100-378-420-10	10	
2	チューブスペーサ TUBE SPACER	 60	19-631-4031-0 CODE NO. 100-379-740-10	1	
3	セルフタッピングボルト SELF-TAPPING SCREW	 20 φ6	0X20 SUS304 CODE NO. 000-162-613-10	4	
4	ケーブルタイ CABLE TIE	 100	CY-100N CODE NO. 000-162-167-10	22	

型式/コード番号が2取の場合、下段より上段に代わる選定部品であり、どちらかが入っています。なお、品質は変わりません。  
TWO TYPES AND CODES MAY BE LISTED FOR AN ITEM. THE LOWER PRODUCT MAY BE SHIPPED IN PLACE OF THE UPPER PRODUCT.  
QUALITY IS THE SAME.  
(略図の寸法は、参考値です。 DIMENSIONS IN DRAWING FOR REFERENCE ONLY.)

FURUNO ELECTRIC CO., LTD.

C2380-M01-B

CODE NO.	001-436-230-00	026S-X-9401-3
TYPE	CP02-09301	1/1

工事材料表 INSTALLATION MATERIALS		数量 QTY		用途/備考 REMARKS	
番号 NO.	名称 NAME	略図 OUTLINE	型名/規格 DESCRIPTIONS	数量 QTY	用途/備考 REMARKS
1	圧着端子 SELF-TAPPING SCREW 1/2		5X20 SUS304 CODE NO. 1000-162-608-10	4	
2	圧着端子 CRIMP-ON LUG		FV1-25-4 (LF) RED K CODE NO. 1000-166-666-11	1	
3	圧着端子 CRIMP-ON LUG		FV2-44 K CODE NO. 1000-157-229-11	2	
4	7-ス板 COPPER STRAP		WEA-1004-0 ROHS CODE NO. 500-310-040-10	1	

(略図の寸法は、参考値です。 DIMENSIONS IN DRAWING FOR REFERENCE ONLY.)

FURUNO ELECTRIC CO., LTD.

CODE NO.	001-205-650-00	19BD-X-9501-0
TYPE	FP19-01801	1/1

付属品表 ACCESSORIES		数量 QTY		用途/備考 REMARKS	
番号 NO.	名称 NAME	略図 OUTLINE	型名/規格 DESCRIPTIONS	数量 QTY	用途/備考 REMARKS
1	ハンガ-ワッシャー HANGER WASHER		05-029-0132-1 ROHS CODE NO. 100-087-911-10	2	
2	7' ライト プ-#2N2.5 BLIND SEAL 2 N2.5		05-104-6604-0 CODE NO. 100-373-480-10	2	
3	7' (N2.5) KNOB (N2.5)		19-028-2073-1 CODE NO. 100-340-481-10	2	
4	ヒューズ ラベル FUSE LABEL		19-031-1561-0 CODE NO. 100-372-600-10	1	

型式/コード 番号が2取の場合、下段より上段に代わる通達部品であり、どちらかが入っています。 なお、品質は変わりません。  
TWO TYPES AND CODES MAY BE LISTED FOR AN ITEM. THE LOWER PRODUCT MAY BE SHIPPED IN PLACE OF THE UPPER PRODUCT.  
QUALITY IS THE SAME. DIMENSIONS IN DRAWING FOR REFERENCE ONLY.)

FURUNO ELECTRIC CO., LTD.



表1 TABLE 1

寸法区分 (mm) DIMENSION	公差 (mm) TOLERANCE
L ≤ 50	±1.5
50 < L ≤ 100	±2.5
100 < L ≤ 500	±3

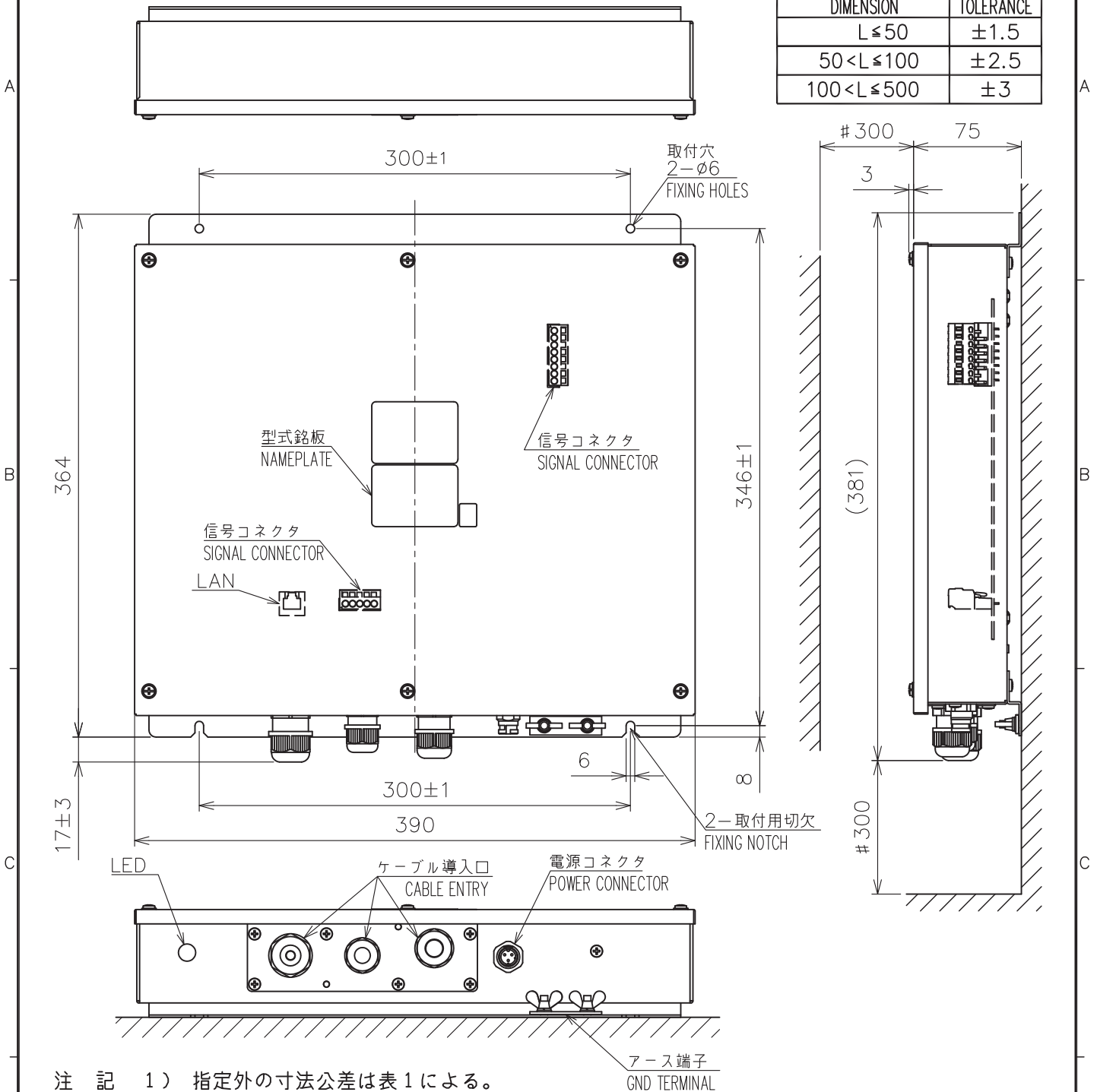

- 注 記
- 1) 指定外の寸法公差は表 1 による。
  - 2) # 印寸法は最小サービス空間寸法とする。
  - 3) 取付用ネジはトラスタップピンネジ呼び径 5 × 20 を使用のこと。

- NOTE
1. TABLE 1 INDICATES TOLERANCE OF DIMENSIONS WHICH IS NOT SPECIFIED.
  2. #: MINIMUM SERVICE CLEARANCE.
  3. USE TAPPING SCREWS  $\phi 5 \times 20$  FOR FIXING THE UNIT.

DRAWN 16/Nov/2015 T.YAMASAKI		TITLE FCV-2102
CHECKED 16/Nov/2015 H.MAKI		名称 送受信部
APPROVED 16/Nov/2015 H.MAKI	FCV-2100	外寸図
SCALE 1/4	MASS 5.5 ±10% kg	NAME TRANSCEIVER UNIT
DWG. No. C2391-G01-A	REF. No. 02-172-100G-2	OUTLINE DRAWING





表1 TABLE 1

寸法区分 (mm) DIMENSION	公差 (mm) TOLERANCE
$L \leq 50$	$\pm 1.5$
$50 < L \leq 100$	$\pm 2.5$
$100 < L \leq 500$	$\pm 3$

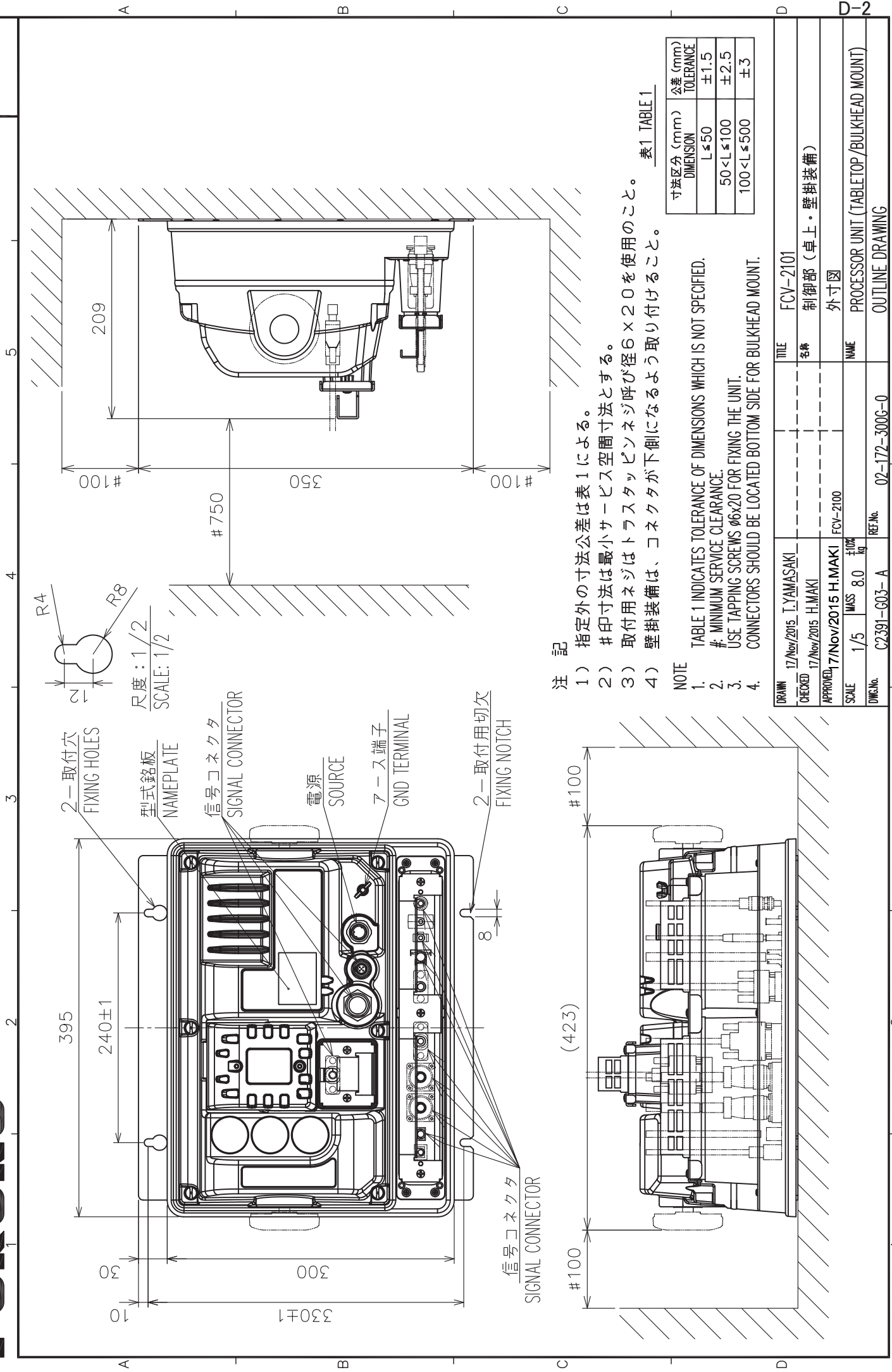
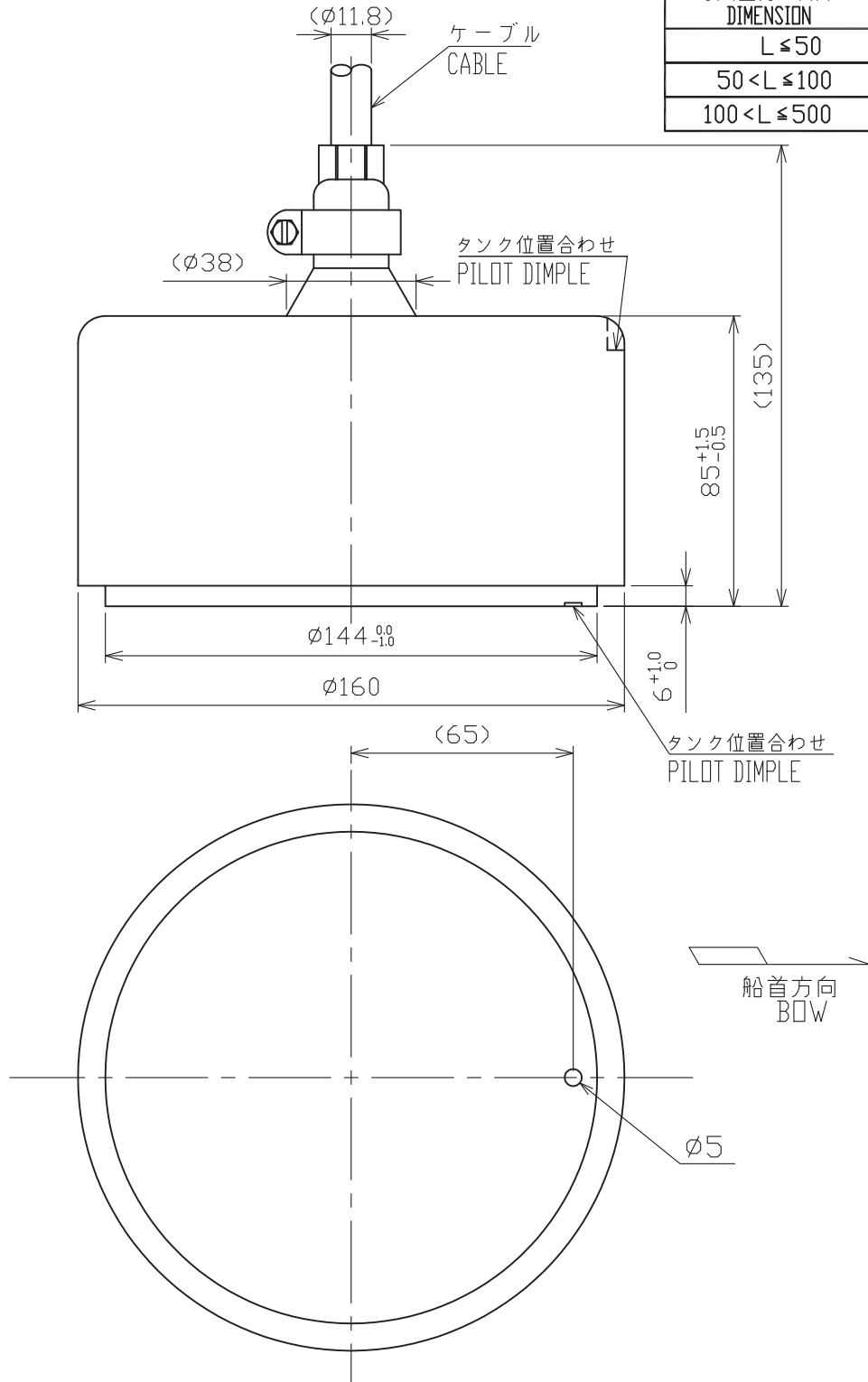

注記

1) 指定外の寸法公差は表1による。

NOTE

1. TABLE 1 INDICATES TOLERANCE OF DIMENSIONS WHICH IS NOT SPECIFIED.

DRAWN 25/Feb/2016 T. YAMASAKI	TITLE FCV-2103
CHECKED 25/Feb/2016 H. MAKI	名称 送受波器
APPROVED 26/Feb/2016 H. MAKI	外寸図
SCALE 1/2	MASS 7 kg
DWGNo. C2391-G02-B	REF.No. 02-172-600G-1
FCV-2100 質量はケーブル(30m)を含む。 MASS INCLUDES 30m CABLE.	
NAME TRANSDUCER	
OUTLINE DRAWING	



表 1 TABLE 1

寸法区分 (mm) DIMENSION	公差 (mm) TOLERANCE
L ≤ 50	±1.5
50 < L ≤ 100	±2.5
100 < L ≤ 500	±3

背面  
REAR VIEW

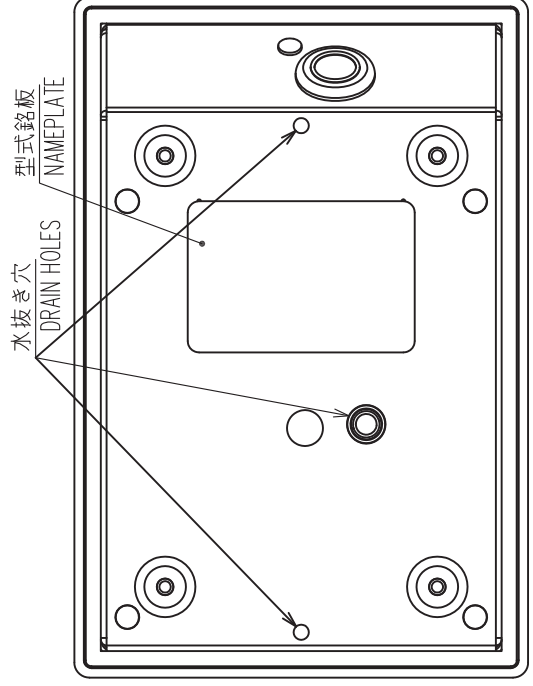
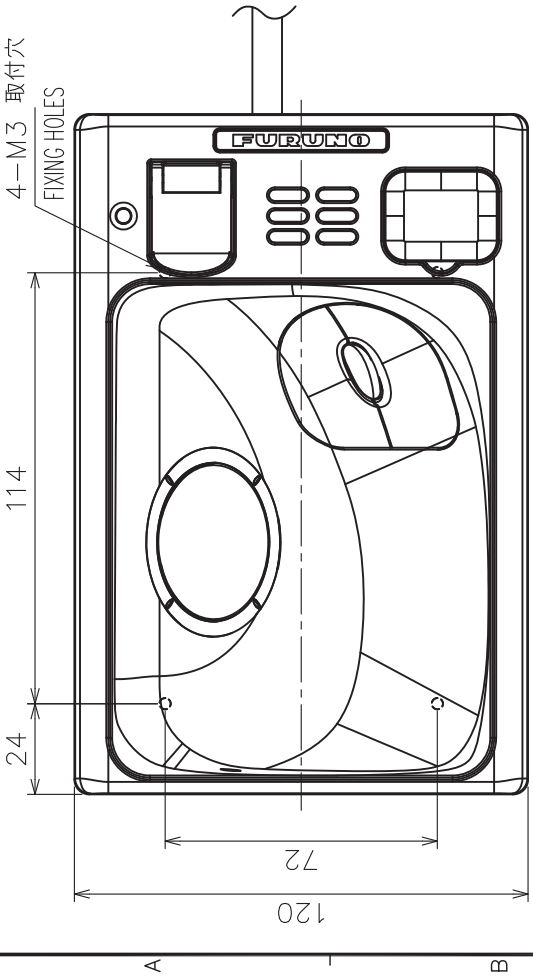
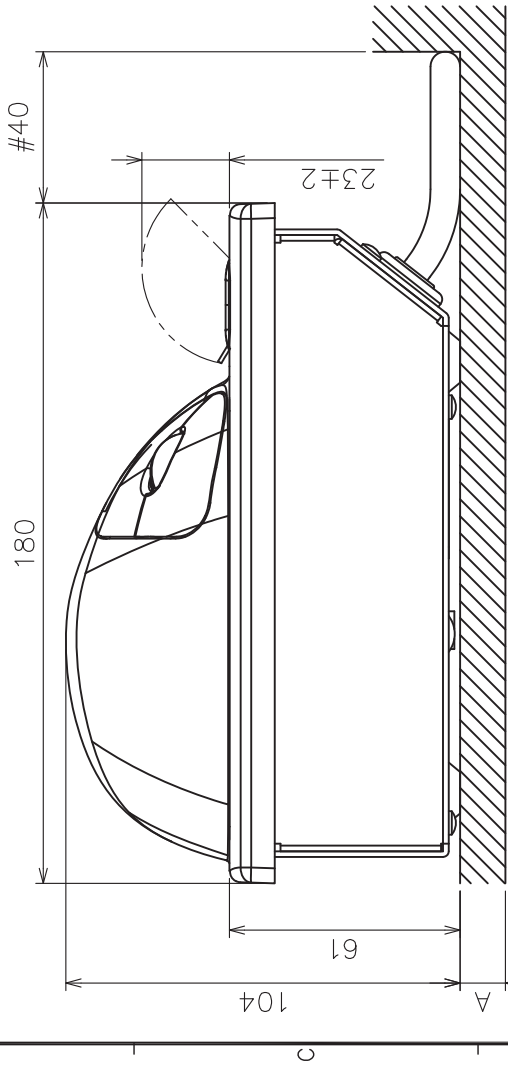

- 注 記
- 1) 指定外の寸法公差は表 1 による。
  - 2) # 印寸法は最小サービスペース寸法とする。
  - 3) 取付ネジはセムスネジ B M3 を使用のこと。  
ネジ長さは A (壁の厚さ) + 8 ± 2 mm とする
- NOTE
1. TABLE 1 INDICATES TOLERANCE OF DIMENSIONS WHICH IS NOT SPECIFIED.
  2. #: MINIMUM SERVICE CLEARANCE.
  3. USE SEMS B M3 SCREWS FOR FIXING THE UNIT.  
SCREW LENGTH: (A)+8±2. A: BULKHEAD THICKNESS.

DRAWN	16/Nov/2011	T.YAMASAKI	TITLE	TCU-001
CHECKED	16/Nov/2011	H.MAKI	名称	トラックボール操作部 (卓上装備)
APPROVED	17/Nov/2011	Y.NISHIYAMA	外寸図	
SCALE	1/2	質量はケーブル (5m) を含む。 ±0.4g MASS INCLUDES CABLE (5m).	NAME	TRACKBALL CONTROL UNIT (TABLETOP MOUNT)
DMC No.	C4466-G02-B	REF.No.	14-078-200G-1	OUTLINE DRAWING



表 1 TABLE 1

寸法区分 (mm) DIMENSION	公差 (mm) TOLERANCE
$L \leq 50$	$\pm 1.5$
$50 < L \leq 100$	$\pm 2.5$
$100 < L \leq 500$	$\pm 3$

DRAIN HOLES 水抜き穴

型式銘板  
NAMEPLATE

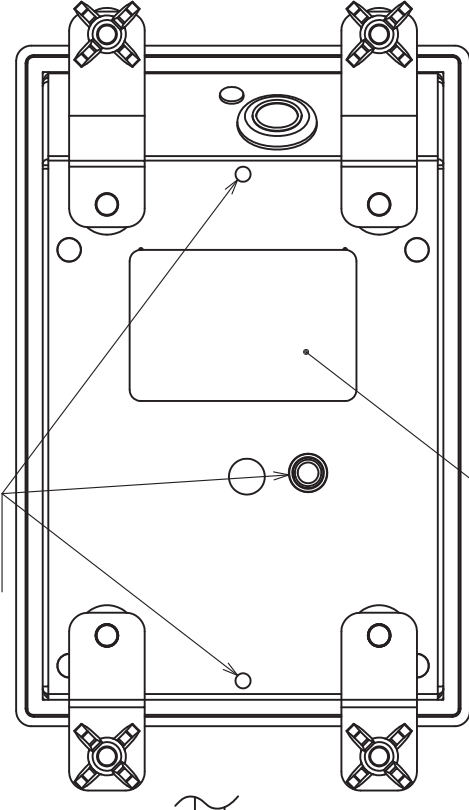
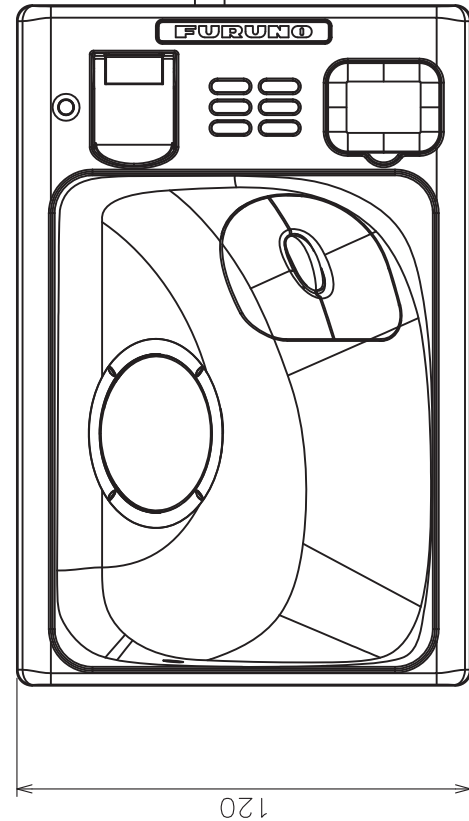
背面  
REAR VIEW

#60

180

#60

55

17

9

35±2

MAX 70

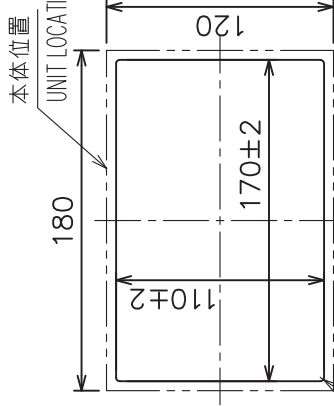
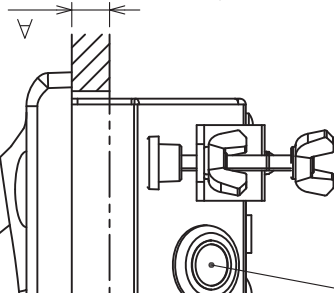
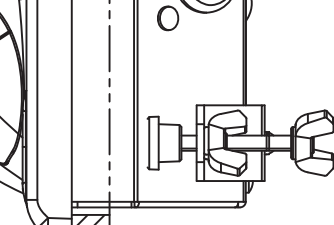

本体位置  
UNIT LOCATION

取付穴寸法図 (尺度1/4)  
CUTOUT DIMENSIONS (SCALE: 1/4)

ケーブル導入孔  
CABLE ENTRY

- 注記
- 1) 指定外の寸法公差は表 1 による。
  - 2) # 印寸法は最小サービス空間寸法とする。
  - 3) 壁の厚さ (A) は最小 10 mm、最大 20 mm とする。

- NOTE
1. TABLE 1 INDICATES TOLERANCE OF DIMENSIONS WHICH IS NOT SPECIFIED.
  2. # MINIMUM SERVICE CLEARANCE.
  3. BULKHEAD THICKNESS(A):  $10 \leq A \leq 20$

DRAWN	16/Nov/2011	T.YAMASAKI	TITLE	TCU-001
CHECKED	16/Nov/2011	H.MAKI	名称	トラックボール操作部 (埋込装備)
APPROVED	17/Nov/2011	Y.NISHIYAMA	外寸図	
SCALE	1/2	質量はケーブル (5m) を含む。 ±0.4g MASS INCLUDES CABLE (5m).	NAME	TRACKBALL CONTROL UNIT (FLUSH MOUNT)
DWG.No.	C4466-G03-B	REF.No.	14-078-210G-1	OUTLINE DRAWING

(179.9)

2-φ6.5 取付穴  
FIXING HOLES

水抜き穴  
DRAIN HOLES



表 1 TABLE 1

寸法区分 (mm) DIMENSION	公差 (mm) TOLERANCE
L ≤ 50	±1.5
50 < L ≤ 100	±2.5
100 < L ≤ 500	±3

矢視 B  
VIEW B

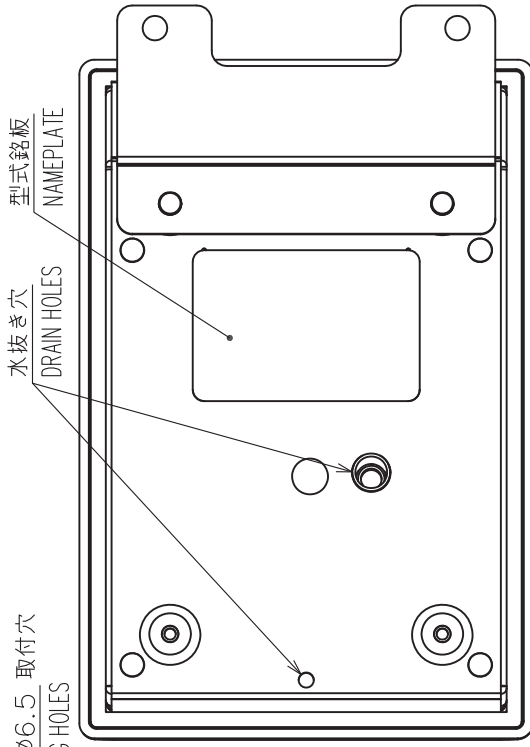
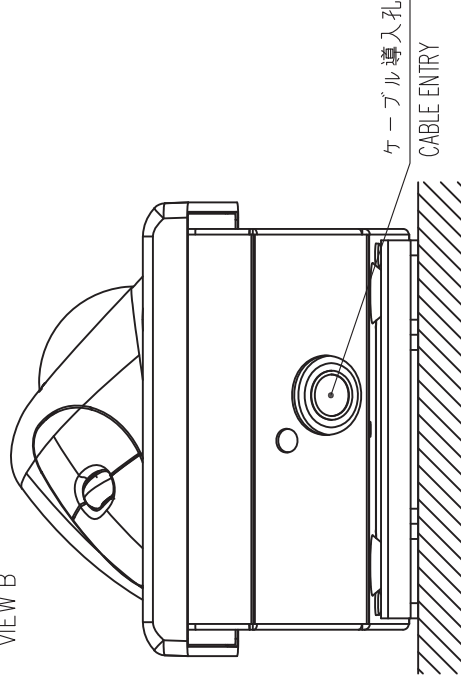
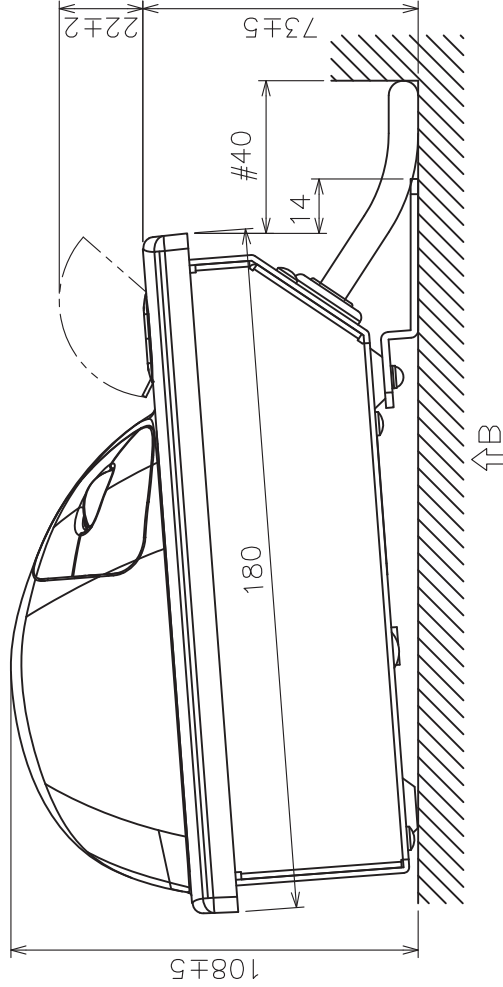

ケーブル導入口  
CABLE ENTRY

- 注 記
- 1) 指定外の寸法公差は表 1 による。
  - 2) # 印寸法は最小サービスマージン寸法とする。
  - 3) 取付ネジはトラスタップネジ呼び径 5 × 2.0 を使用のこと。
- NOTE
1. TABLE 1 INDICATES TOLERANCE OF DIMENSIONS WHICH IS NOT SPECIFIED.
  2. #: MINIMUM SERVICE CLEARANCE.
  3. USE TAPPING SCREWS φ5x2.0 FOR FIXING THE UNIT.

DRAWN	16/Nov/2011	T.YAMASAKI	TITLE	TCU-001
CHECKED	16/Nov/2011	H.MAKI	名称	トラックボール操作部 (取付金具装備)
APPROVED	17/Nov/2011	Y.NISHIYAMA	外寸図	
SCALE	1/2	質量はケーブル (5m) を含む。 ±0.4g 質量はケーブル (5m) を含む。 ±0.4g	NAME	TRACKBALL CONTROL UNIT (FIXTURE MOUNT)
DWG.No.	C4466-G04-B	REF.No.	14-078-220G-1	OUTLINE DRAWING



表2 (Table 2)

送受波器 TRANSDUCER	規格記号 SPECIFICATION JIS (単位)
TRANSDUCER	43.20.78
200B-12H	○
150B-12H	○
82B-12C	○
FCV-2103	○

表1 (Table 1)

寸法区分 (mm) Dimension	公差 (mm) Tolerance
L ≤ 50	±1.5
50 < L ≤ 100	±2.5
100 < L ≤ 500	±3

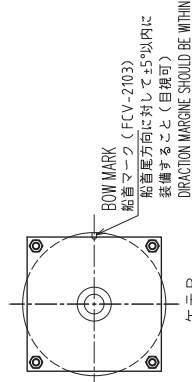
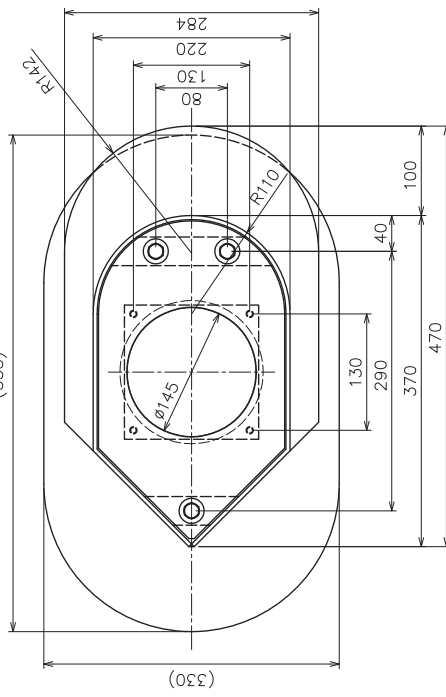
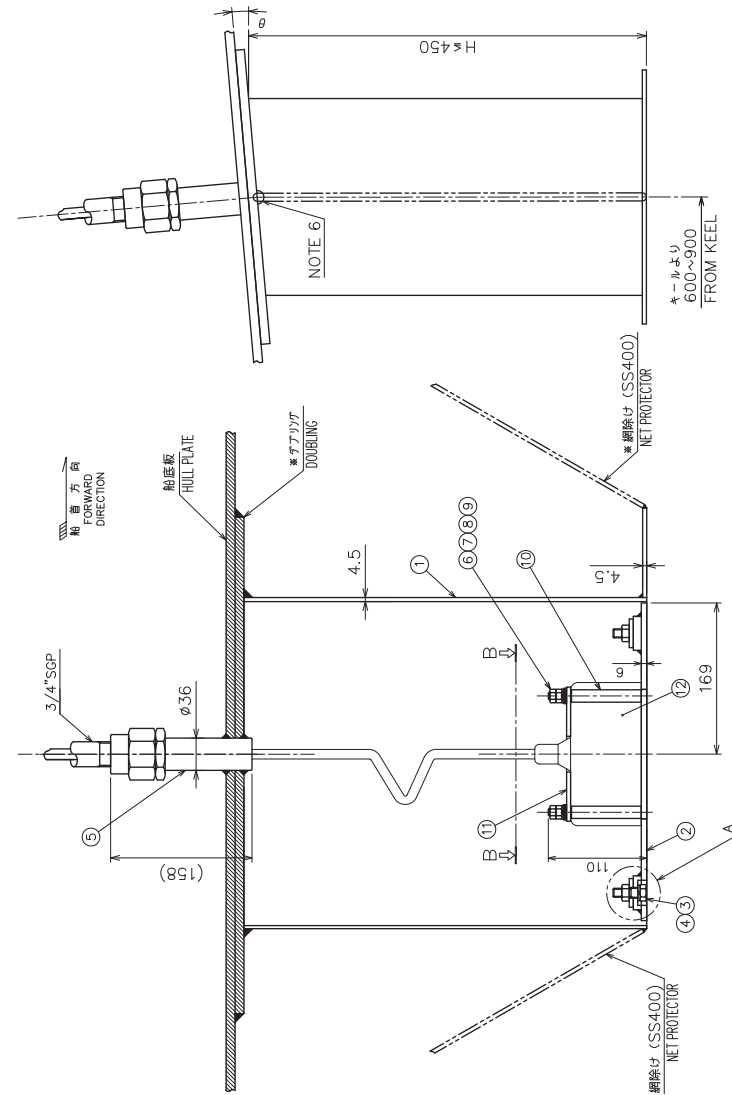
項目 ITEMS	単位 UNIT
船首から FROM BOW	m
キールから FROM KEEL	mm
突出量 H PROJECTION	mm
取付状態 INSTALLATION CONDITION	走行時水平 AT RUNNING
保護タンク PROTECTION TANK	材質 MATERIAL

注記

- ※：造船所手配。
- 送受波器ケースはθ（船底傾斜角）にあわせて切断してください。
- 送受波器ケースは、至り防止のため送受波器を取り外した状態でフレンジを必ず取り付けてください。溶接方法は造船所一任。
- 電線敷金物を溶接する際は、パッキンは取り外し行ってください。
- 送受波器ケースを溶接する際は船首尾方向を確認してください。
- 船首方向の取り付け誤差は±5°以内としてください。
- 船尾側上端に空気抜用穴（φ1.0~φ2.0程度）をあけてください。
- 電線敷金物はフレーム等の邪魔にならない所で送受波器に当たらず、キャップナットが容易に締め付けられる位置に取り付けてください。
- 網掛け、保護タンクは必要に応じて造船所で製作してください。
- 塗装後はサビ止め塗装をかけた後正視の塗装をおこなってください。
10. 塗装の際、送受波器面を塗れない様に注意してください。
11. 送受波器取り付け後、A 部の隙間をシリコン等で埋めてください。
12. 指定外の寸法公差は、表1の通りです。
13. ボルト類には焼付防止クリス（モリシュー1910等）を塗布してください。
14. 送受波器とスベークの組合せは表2の通り。

- ※：SHIPYARD SUPPLY.
- CUT CASING FOR θ (ARISING ANGLE OF SHIP'S HULL) TRANSDUCER ONTO CASING WHILE CUTTING AND/OR WELDING.
- TO AVOID DISTORTION BY HEAT, PUT THE FIXING FLANGE WITHOUT WELDING SHOULD BE DONE BY SHIPYARD.
- REMOVE THE GASKET FROM THE THRU-HULL PIPE BEFORE WELDING.
- MAKE SURE THE FORE-AFT DIRECTION OF CASING. (DIRECTION MARGIN WITHIN ±5°)
- MAKE A HOLE OF 10 TO 20 mm IN DIAMETER ON THE STERN SIDE OF TANK TO ALLOW AIR TO ESCAPE.
- ALLOW ENOUGH CLEARANCE AROUND THRU-HULL PIPE FOR EASY TIGHTENING AND SERVICING.
- IF NECESSARY, PROVIDE NET PROTECTOR AND PROTECTION TANK BY SHIPYARD.
- AFTER THE INSTALLATION, REMOVE THE ANTICORROSION PAINT FROM THE CASING AND THEN PAINT ACCORDING TO SHIPYARD INSTRUCTIONS.
- DO NOT PAINT TRANSDUCER FACE
- FILL THE GAP ON POSITION 'A' WITH SILICONE SEALANT.
- TABLE 1 INDICATES TOLERANCE OF DIMENSIONS WHICH IS NOT SPECIFIED.
- APPLY BURN PREVENTION GREASE TO THREAD OF BOLTS.
- TABLE 2 INDICATES TRANSDUCER AND SPACER COMBINATION.

送受波器 TRANSDUCER	規格記号 SPECIFICATION	選択 SELECT
12	200B-12H 150B-12H 82B-12C FCV-2103	
11	固定板 FIXING PLATE	SS400 T-615-02
10	スペーサー SPACER	SGP T-615-02 T-615-03 T-615-05
9	平皿 FLAT WASHER	P.C #F78 MONI.8
8	平皿 FLAT WASHER	SUS316L M8
7	スペーサー SPACER	SUS316L M8
6	六角ナット HEX. NUT	SUS316L M8
5	電線敷金物 FIXING FLANGE	1 TFB-5000
4	固定板 FIXING PLATE	SUS316L M10
3	六角ボルト HEX. BOLT	SUS316L M10x30
2	固定フランジ FIXING FLANGE	SS400 T-615-01
1	送受波器ケース CASING	SS400 T-611-01

TITLE	
図番 DRAWING No.	原簿 FILE No.
TITLE T-615	
名称 送受波器タンク (鋼船)	
送受波器装備図	
NAME TRANSDUCER TANK (STEEL HULL)	
TRANSDUCER INSTALLATION	
DRAWN 7/Mar/2016 I.YAMASAKI	
CHECKED 8/Mar/2016 H.MAKI	
APPROVED 8/Mar/2016 H.MAKI	
SCALE 1/10	質量は送受波器を含まず MASS DOES NOT INCLUDE TRANSDUCER.
DWG No. C2001-144-A	Ref. No. T-615-00-3



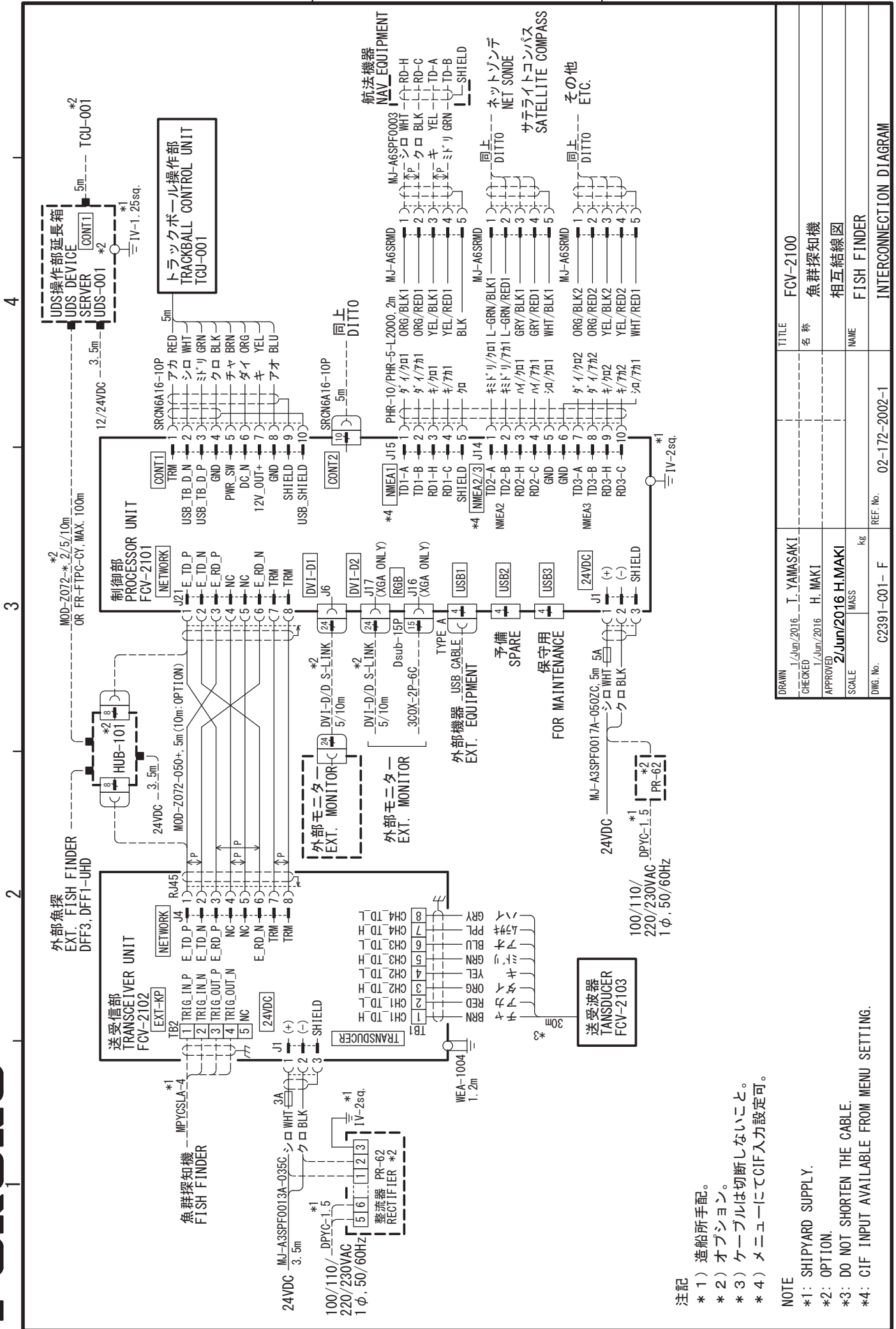

- 注記
- \* 1) 造船所手配。
  - \* 2) オプション。
  - \* 3) ケーブルは切断しないこと。
  - \* 4) メニューにてCIF入力設定可。

NOTE

- \*1: SHIPYARD SUPPLY.
- \*2: OPTION.
- \*3: DO NOT SHORTEN THE CABLE.
- \*4: CIF INPUT AVAILABLE FROM MENU SETTING.

DRAWN	1/Jan/2016	T. YAMASAKI	TITLE	FCV-2100
CHECKED	1/Jan/2016	H. MAKI	名称	魚群探知機
APPROVED	2/Jan/2016	H. MAKI	相互結線図	
SCALE	MASS		NAME	FISH FINDER
DWG. No.	C2391-001-F	REF. No.	02-172-2002-1	INTERCONNECTION DIAGRAM