

FURUNO

OPERATOR'S MANUAL

*SEARCHLIGHT SONAR/
DUAL-FREQUENCY
SEARCHLIGHT SONAR*

CH-500

Model

CH-600

FURUNO ELECTRIC CO., LTD.

9-52 Ashihara-cho,
Nishinomiya, 662-8580, JAPAN

• FURUNO Authorized Distributor/Dealer

All rights reserved. Printed in Japan

Pub. No. OME-13540-F1

(GREG) CH-500/CH-600

A : MAR. 2017
F1 : DEC. 08, 2022



0 0 0 1 9 2 2 0 8 1 5

IMPORTANT NOTICES

General

- This manual has been authored with simplified grammar, to meet the needs of international users.
- The operator of this equipment must read and follow the instructions in this manual. Wrong operation or maintenance can void the warranty or cause injury.
- Do not copy any part of this manual without written permission from FURUNO.
- If this manual is lost or worn, contact your dealer about replacement.
- The contents of this manual and the equipment specifications can change without notice.
- The example screens (or illustrations) shown in this manual can be different from the screens you see on your display. The screens you see depend on your system configuration and equipment settings.
- Save this manual for future reference.
- Any modification of the equipment (including software) by persons not authorized by FURUNO will void the warranty.
- The following concern acts as our importer in Europe, as defined in DECISION No 768/2008/EC.
 - Name: FURUNO EUROPE B.V.
 - Address: Siriusstraat 86, 5015 BT, Tilburg, The Netherlands
- The following concern acts as our importer in UK, as defined in SI 2016/1025 as amended SI 2019/470.
 - Name: FURUNO (UK) LTD.
 - Address: West Building Penner Road Havant Hampshire PO9 1QY, U.K.
- All brand, product names, trademarks, registered trademarks, and service marks belong to their respective holders.

How to discard this product

Discard this product according to local regulations for the disposal of industrial waste. For disposal in the USA, see the homepage of the Electronics Industries Alliance (<http://www.eiae.org/>) for the correct method of disposal.

How to discard a used battery

Some FURUNO products have a battery(ies). To see if your product has a battery, see the chapter on Maintenance. Follow the instructions below if a battery is used. Tape the + and - terminals of battery before disposal to prevent fire, heat generation caused by short circuit.

In the European Union

The crossed-out trash can symbol indicates that all types of batteries must not be discarded in standard trash, or at a trash site. Take the used batteries to a battery collection site according to your national legislation and the Batteries Directive 2006/66/EU.

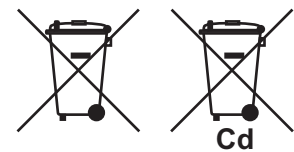

In the USA

The Mobius loop symbol (three chasing arrows) indicates that Ni-Cd and lead-acid rechargeable batteries must be recycled. Take the used batteries to a battery collection site according to local laws.

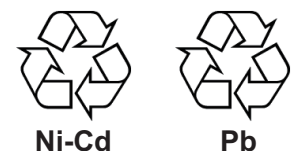

In the other countries

There are no international standards for the battery recycle symbol. The number of symbols can increase when the other countries make their own recycle symbols in the future.



SAFETY INSTRUCTIONS

The operator must read the safety instructions before attempting to operate the equipment.



DANGER

Indicates a potentially hazardous situation which, if not avoided, will result in death or serious injury.



WARNING

Indicates a potentially hazardous situation which, if not avoided, could result in death or serious injury.



CAUTION

Indicates a potentially hazardous situation which, if not avoided, could result in minor or moderate injury.



Warning, Caution



Prohibitive Action



Mandatory Action



DANGER



Keep away from raise/lower shaft in hull unit when the shaft is moving.

Contact with the gears and raise/lower shaft will cause serious injury.



WARNING



Do not open the equipment.

The equipment uses high voltage that can cause electrical shock. Refer any repair work to a qualified technician.



If water leaks into the equipment or something is dropped into the equipment, immediately turn off the power at the switchboard.

Fire or electrical shock can result.



If the equipment is giving off smoke or fire, immediately turn off the power at the switchboard.

Fire or electrical shock can result.



WARNING



Do not disassemble or modify the equipment.

Fire, electrical shock or serious injury can result.



Make sure no rain or water splash leaks into the equipment.

Fire or electrical shock can result if water leaks into the equipment.



Do not operate the equipment with wet hands.

Electrical shock can result.



Use the proper fuse.

Use of the wrong fuse can cause fire or electrical shock.



If you feel the equipment is acting abnormally or giving off strange noises, immediately turn off the power at the switchboard and contact a FURUNO service technician.

⚠ CAUTION

! To prevent damage to the transducer, the maximum ship's speed while the transducer is projected or being raised or lowered is as follows:

| | |
|------------|---------------------|
| Projected | Raising or lowering |
| Max. 20 kn | Max. 15 kn |

! Observe the following when using sonar oil.

Precautions

- Keep the sonar oil away from eyes. Wear protective goggles when working with the sonar oil.
- Do not touch the sonar oil. Wear protective gloves when working with the sonar oil.
- The sonar oil can cause inflammation of the skin.
- Do not ingest the sonar oil. Diarrhea and vomiting can result.
- Keep the sonar oil out of reach of children.

Emergency procedures

- If the sonar oil enters eyes, flush with clean water for about 15 minutes. Consult a physician.
- If the sonar oil contacts skin, flush the area with clean water.
- If the sonar oil is ingested, see a physician immediately.

Storage

Seal container to keep out foreign material. Store in dark, cool place.

Disposal of sonar oil and its container

Dispose of the sonar oil and its container in accordance with local regulations. If you are unclear about the disposal procedure, contact the place of purchase.

! Remove marine life from the face of the transducer when the ship is dry-docked.

Marine life affects the performance of transmission/reception and results in low sensitivity.

⚠ CAUTION

! Retract the transducer before turning the power off.

Damage to the equipment can result. Wait until the transducer retraction switch [] lights steadily, then turn the power off.

! Do not paint the transducer, and handle it with care.

Paint affects sensitivity.

⊘ Do not place liquid-filled containers on or near the equipment.

Fire or electrical shock can result if a liquid spills into the equipment.

! Keep the raise/lower unit powered when underway.

Failure to keep the raise/lower unit powered can result in damage to the raise/lower unit or loss of the transducer.

Warning Label(s)

Warning label(s) is(are) attached to the equipment. Do not remove the label(s). If a label is missing or damaged, contact a FURUNO agent or dealer about replacement.

| |
|---|
| ⚠ WARNING ⚠ |
| To avoid electrical shock, do not remove cover. No user-serviceable parts inside. |
| ⚠ 警告 ⚠ |
| 感電の恐れあり。 サービスマン以外の方はカバーを開けないで下さい。内部には高電圧部分が多い数多くあり、万一さわると危険です。 |

Name: Warning Label 1
Type: 86-003-1011-1
Code No.: 100-236-231

| |
|--|
| ⚠ DANGER |
| Keep fingers away from gears. Shaft may cause injury. Keep away from moving shaft. |
| ⚠ 危険 |
| ギヤに巻き込まれる恐れあり。上下動シャフトにより、けがをする恐れあり。稼働中は近づかないこと。 |

Name: Warning Label
Type: 10-071-5313
Code No.: 100-291-160

| |
|---|
| ⚠ DANGER |
| Electrical shock hazard. Do not remove cover. No user-serviceable parts inside. Turn off power before servicing. And wait until charge lamp (green) goes off and then remove cover. |
| ⚠ 危険 |
| 感電の恐れあり。 サービスマン以外の方は、カバーを開けないで下さい。内部には高電圧部分が多い数多くあり、万一さわると危険です。 サービスマンがカバーを開ける場合は、電源を切った後、CHARGEランプ(緑)が消灯していることを確認してから開けてください。 |

Name: Warning Label
Type: 10-079-6144
Code No.: 100-310-880

| |
|---|
| ⚠ WARNING ⚠ |
| To avoid electrical shock, do not remove cover. No user-serviceable parts inside. |
| ⚠ 警告 ⚠ |
| 感電の恐れあり。 サービスマン以外の方はカバーを開けないで下さい。内部には高電圧部分が多い数多くあり、万一さわると危険です。 |

Name: Warning Label (2)
Type: 03-129-1001-1
Code No.: 100-236-741

TABLE OF CONTENTS

| | |
|---|------------|
| FOREWORD | vii |
| SYSTEM CONFIGURATION | ix |
| 1. OPERATIONAL OVERVIEW | 1-1 |
| 1.1 Description of Controls | 1-1 |
| 1.1.1 Control Units | 1-1 |
| 1.1.2 Remote Control Unit CH-256 (option) | 1-2 |
| 1.2 How to Turn the Power On/Off | 1-2 |
| 1.2.1 How to turn the power on | 1-2 |
| 1.2.2 How to turn the power off | 1-3 |
| 1.3 How to Raise/Lower the Transducer | 1-3 |
| 1.3.1 How to lower the transducer | 1-3 |
| 1.3.2 How to raise the transducer | 1-5 |
| 1.4 How to Adjust the Brilliance | 1-5 |
| 1.5 How to Select a Display Mode | 1-6 |
| 1.6 How to Adjust the Gain | 1-8 |
| 1.7 How to Use the Menu | 1-9 |
| 1.8 Noise and Interference | 1-10 |
| 1.8.1 Sea Surface Reflections (Horizontal Mode) | 1-10 |
| 1.8.2 Wake Noise (Horizontal Mode) | 1-10 |
| 1.8.3 Sidelobe Echo/False Echo (Horizontal Mode) | 1-11 |
| 1.8.4 False Echo (Vertical Mode) | 1-11 |
| 1.8.5 Interference from other equipment | 1-12 |
| 1.8.6 Interference from marine life | 1-12 |
| 1.8.7 How to erase weak echoes | 1-13 |
| 1.9 How to Use the Cursor | 1-13 |
| 1.10 How to Adjust the Range | 1-14 |
| 1.11 How to Use the Train Controls | 1-16 |
| 1.11.1 How to change the train direction | 1-16 |
| 1.11.2 Train controls for horizontal mode | 1-16 |
| 1.11.3 Train controls for vertical mode | 1-17 |
| 1.11.4 Train control for echo sounder mode | 1-17 |
| 1.12 How to Use the Tilt Controls | 1-18 |
| 1.12.1 Tilt control for horizontal modes | 1-18 |
| 1.12.2 Tilt control for vertical mode | 1-18 |
| 1.12.3 Tilt control for echo sounder mode | 1-18 |
| 1.13 How to Use the Sector Function | 1-19 |
| 1.13.1 How to set and use a sector with horizontal mode | 1-19 |
| 1.13.2 How to set and use a sector with vertical mode | 1-20 |
| 1.13.3 How to set a sector center (vertical mode only) | 1-21 |
| 1.14 How to Use the Event Marker | 1-22 |
| 1.14.1 How to inscribe an event mark | 1-22 |
| 1.14.2 How to delete event marks | 1-23 |
| 1.15 How to Use the Range/Bearing Marker | 1-23 |
| 1.16 How to Use the Tracking Function | 1-25 |
| 1.16.1 How to select the tracking method | 1-25 |
| 1.16.2 Position tracking function | 1-25 |
| 1.16.3 Echo tracking function | 1-26 |
| 1.16.4 Reverse tracking function (Horizontal mode only) | 1-27 |

| | | |
|-----------|--|------------|
| 2. | HORIZONTAL MODE | 2-1 |
| 2.1 | Operational Overview | 2-1 |
| 2.2 | Horizontal Menu Overview | 2-2 |
| 2.3 | Mix Display (CH-600 only)..... | 2-3 |
| 2.4 | Typical Horizontal Mode | 2-5 |
| 2.5 | Full-circle A-Scope Mode | 2-6 |
| 2.6 | Horizontal Mode (Zoomed)..... | 2-7 |
| 2.7 | Horizontal + History Mode | 2-8 |
| 2.8 | Horizontal + Vertical Mode | 2-9 |
| 2.9 | How to Choose a Frequency (CH-600 only)..... | 2-10 |
| 2.9.1 | Choosing the frequency | 2-10 |
| 2.9.2 | Choosing the combination display..... | 2-11 |
| 2.10 | How to Interpret the Horizontal Display | 2-12 |
| 2.11 | How to Select the Training Speed | 2-15 |
| 2.12 | How to Use the Vertical Search Feature | 2-15 |
| 2.13 | How to Adjust the Picture | 2-16 |
| 2.13.1 | How to suppress seabed/surface reflections with TX power | 2-16 |
| 2.13.2 | How to suppress bottom tail with pulselength | 2-16 |
| 2.13.3 | How to display weak echoes clearly with TVG | 2-17 |
| 3. | VERTICAL SCAN MODE | 3-1 |
| 3.1 | Vertical Mode..... | 3-1 |
| 3.2 | Vertical Menu Overview..... | 3-2 |
| 3.3 | How to Interpret the Vertical Scan Display | 3-3 |
| 3.4 | How to Toggle Full/Half Range Scans..... | 3-4 |
| 3.5 | How to Select the Training Speed | 3-4 |
| 3.6 | How to Adjust the Picture | 3-4 |
| 4. | ECHO SOUNDER MODE | 4-1 |
| 4.1 | Typical Echo Sounder Display..... | 4-1 |
| 4.2 | Echo Sounder Menu Overview..... | 4-2 |
| 4.3 | How to Adjust the Range..... | 4-3 |
| 4.4 | How to Adjust the Tilt..... | 4-3 |
| 4.5 | How to Select the Picture Advance Speed..... | 4-3 |
| 4.6 | How to Adjust the Picture | 4-4 |
| 4.6.1 | How to adjust the TVG for echo sounder mode | 4-4 |
| 4.6.2 | How to find echo strength with the A-Scope | 4-6 |
| 5. | MENU OPERATIONS | 5-1 |
| 5.1 | How to Access and Use the Menu | 5-1 |
| 5.2 | How to Change the Displayed Language | 5-2 |
| 5.3 | COM1 Menu | 5-2 |
| 5.4 | COM2 Menu | 5-3 |
| 5.5 | System Menu..... | 5-4 |
| 5.6 | FUNC Key Menu | 5-5 |
| 5.6.1 | How to setup the function keys | 5-5 |
| 5.6.2 | Short-cut keys | 5-5 |
| 5.6.3 | Preset keys..... | 5-6 |
| 5.7 | How to Adjust the Preset Range Settings | 5-7 |
| 5.8 | How to Enable/Disable Train Speed Presets | 5-8 |
| 5.9 | How to Change the Displayed Colors..... | 5-8 |
| 5.10 | How to Backup/Restore Settings..... | 5-9 |
| 5.11 | How to Adjust the Transmission Frequency | 5-10 |

TABLE OF CONTENTS

| | | |
|-----------------------|---|-------------|
| 5.12 | How to Adjust the Speaker Settings..... | 5-11 |
| 5.12.1 | How to adjust the speaker frequency..... | 5-11 |
| 5.12.2 | How to select the speaker bandwidth..... | 5-11 |
| 5.12.3 | How to set the harmonic pattern..... | 5-12 |
| 5.12.4 | How to filter for doppler shift..... | 5-12 |
| 5.12.5 | How output sound based on frequency (CH-600 only)..... | 5-12 |
| 5.13 | How to Use the Simulation Mode..... | 5-13 |
| 5.14 | How to Restore the System Menu to Default Settings..... | 5-14 |
| 5.15 | System Settings menu..... | 5-15 |
| 6. | MAINTENANCE, TROUBLESHOOTING..... | 6-1 |
| 6.1 | Preventative Maintenance..... | 6-1 |
| 6.2 | How to Clean the Equipment..... | 6-1 |
| 6.3 | Hull Unit Maintenance..... | 6-2 |
| 6.3.1 | Hull unit lubrication..... | 6-2 |
| 6.3.2 | Manually raise/lower the transducer..... | 6-3 |
| 6.4 | Transducer Maintenance..... | 6-4 |
| 6.5 | How to Replace the Fuses..... | 6-4 |
| 6.6 | Troubleshooting..... | 6-5 |
| 6.7 | Error Messages..... | 6-6 |
| 6.8 | Diagnostics..... | 6-7 |
| 6.8.1 | How to perform a full system test..... | 6-7 |
| 6.8.2 | How to test the LCD..... | 6-8 |
| 6.9 | How to Remove and Re-install the Display Unit..... | 6-9 |
| 6.9.1 | How to remove the display unit..... | 6-9 |
| 6.9.2 | How to re-install the display unit..... | 6-9 |
| APPX. 1 | MENU TREE..... | AP-1 |
| SPECIFICATIONS | | SP-1 |
| INDEX..... | | IN-1 |

FOREWORD

Congratulations on your choice of the FURUNO Searchlight Sonar CH-500, Dual Frequency Searchlight Sonar CH-600. We are confident you will see why the FURUNO name has become synonymous with quality and reliability.

Since 1948, FURUNO Electric Company has enjoyed an enviable reputation for innovative and dependable marine electronics equipment. This dedication to excellence is furthered by our extensive global network of agents and dealers.

This equipment is designed and constructed to meet the rigorous demands of the marine environment. However, no machine can perform its intended function unless installed, operated and maintained properly. Please carefully read and follow the recommended procedures for operation and maintenance.

Features

The CH-500 is a searchlight sonar and the CH-600 is a dual-frequency searchlight sonar. These systems consist of a display unit, a control unit, a transceiver unit and a hull unit.

The main features are:

- Multiple display modes to assist in tracking and monitoring fish schools.
- Customizable function keys for quick access to regularly used functions.
- Display of various data (such as own ship location, depth, etc.) with connection to the appropriate sensors.
- The hull unit automatically raises the transducer when ship's speed exceeds the pre-set speed (requires input of speed data).
- CH-600 can mix the echo of the high frequency and the low frequency. This is useful to identify the small seabed fish which are difficult to identify.

Usage precautions

- If the equipment will not be used for a long time, turn the power off at the mains switchboard to prevent battery discharge.
- If the soundome is to be operated while the ship is dry-docked, set the transmitter output power to "minimum" from the menu. Damage to the train-tilt section may result if the soundome is operated with maximum power while the ship is dry-docked.
- When the ship is dry-docked check for signs of corrosion on the soundome. Find the reason for the corrosion and attach a zinc plate to the hull unit as an anti-corrosion measure if necessary.

Procedures to suppressing the interference

When asked to suppress the interference from other ships, perform the following procedures. The priority to perform the following procedures is as follows.

1. Broadband fish finder or sonar.
 2. Multiple frequency fish finder or sonar.
 3. Single frequency fish finder or sonar.
- Change the TX frequency.

FOREWORD

- Lower the TX power.
- Change the TX cycle.

The CH-500 has the third priority and the CH-600 has the second priority.

Standards used in this manual

- The keys and controls on the Control Units (CH-502, CH-602, CH-256) are shown in bold face; for example, the **MENU** key.
- Menu items and pop-up dialog box names are shown in brackets; for example, [BRILLIANCE] dialog box.

CE/UKCA declaration

With regards to CE/UKCA declarations, please refer to our website (www.furuno.com) for further information about RoHS conformity declarations.

Disclosure of Information about China RoHS

With regards to China RoHS information for our products, please refer to our website (www.furuno.com).

SYSTEM CONFIGURATION

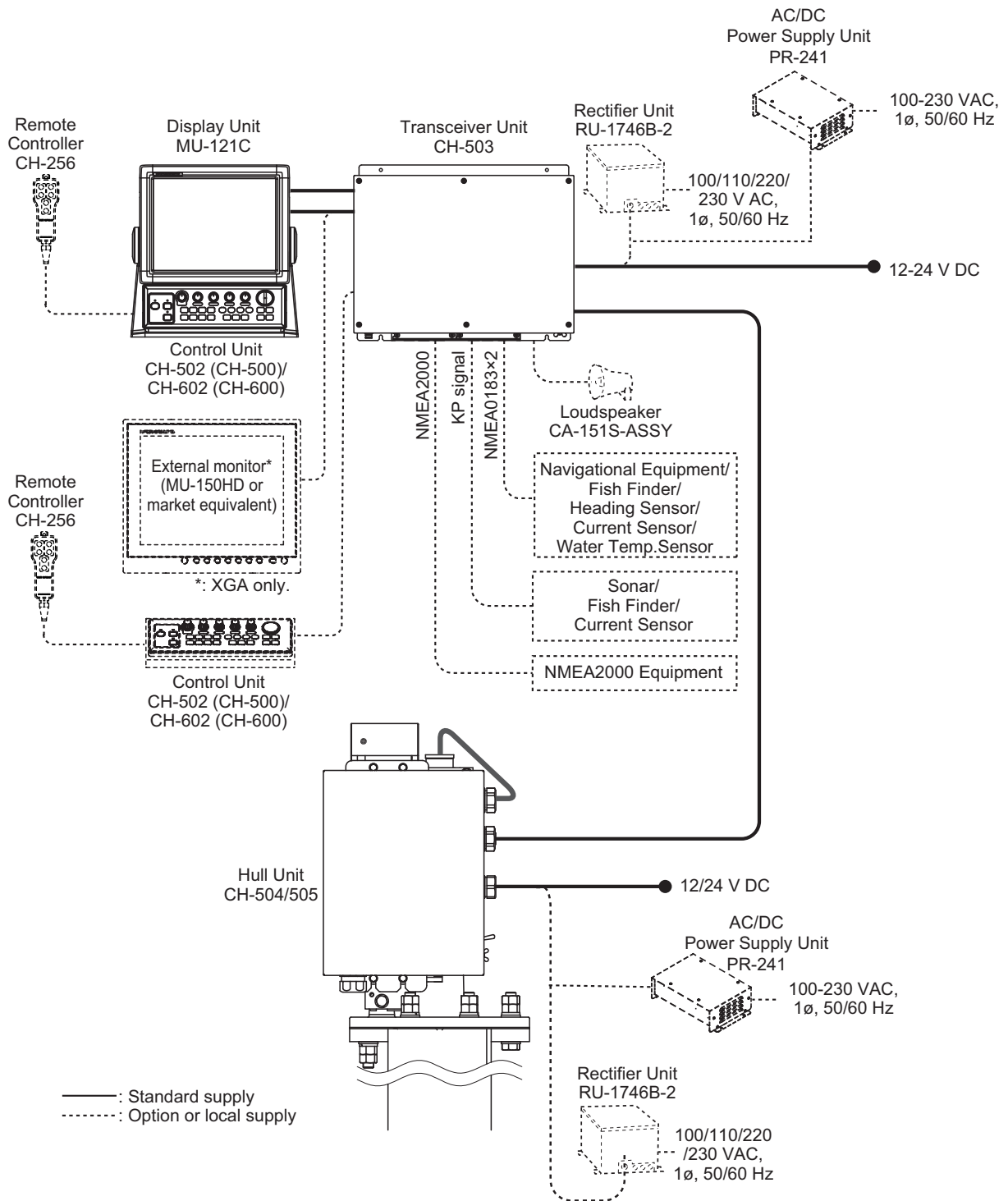

This page is intentionally left blank.

1. OPERATIONAL OVERVIEW

1.1 Description of Controls

1.1.1 Control Units

Control Unit CH-502 (for CH-500)

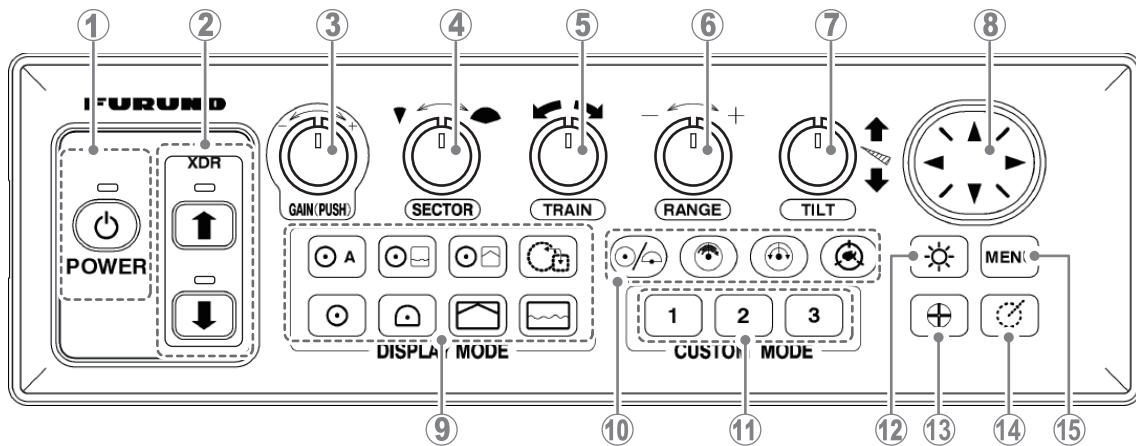

Control Unit CH-602 (for CH-600)

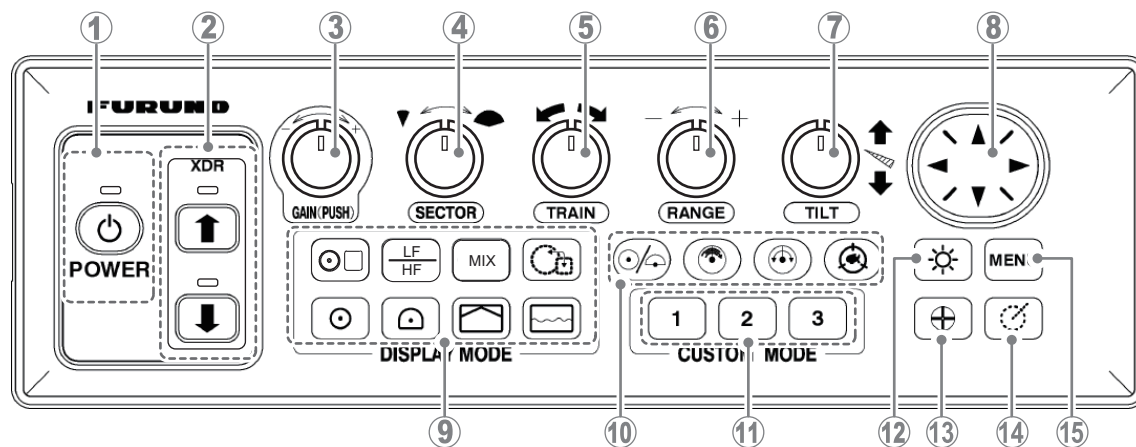

| No. | Control name | Description |
|-----|-------------------------|---|
| 1 | POWER key | Turns the power on/off. See section 1.2. |
| 2 | XDR up/down keys | Raises/lowers the transducer. See section 1.3. |
| 3 | GAIN (PUSH) knob | Adjusts receiver sensitivity (gain). See section 1.6. |
| 4 | SECTOR knob | Selects training sector width. See section 1.13. |
| 5 | TRAIN knob | Selects the center bearing for the training sector. See section 1.11. |
| 6 | RANGE knob | Selects detection range. See section 1.10. |
| 7 | TILT knob | Controls scanning center direction. See section 1.12. |
| 8 | Cursorpad | <ul style="list-style-type: none"> Moves the cursor. Selects menu items and menu options. |
| 9 | Display Mode keys | Changes the display mode. See section 1.5. |

1. OPERATIONAL OVERVIEW

| No. | Control name | Description |
|-----|-------------------------------|---|
| 10 | Scan/track keys | <ul style="list-style-type: none"> • Toggle between full-range scan (360°) and half-range scan (168°). See section 1.13. • Reverse the scanning direction. See section 1.11.1. • Change the train speed. See section 2.11. • Activate/deactivate the tracking function. See section 1.16. |
| 11 | Function keys | Performs custom operations or functions. See section 5.6. |
| 12 | Brilliance key | Adjusts screen and panel brilliance. See section 1.4. |
| 13 | Event Mark key | Places an event mark at the cursor location. Output own ship position data from NMEA2000 port. See section 1.14. |
| 14 | Range/Bearing Mark key | Shows the range/bearing marker. See section 1.15. |
| 15 | MENU key | Opens the menu. See chapter 5. |

1.1.2 Remote Control Unit CH-256 (option)

You can operate the system from up to five meters away with the optional remote control unit.

Note: You can also operate the system while observing the display, if the remote control is installed near the display unit.

| No. | Key name(s) | Description |
|-----|-------------|---|
| 1 | RANGE | Selects detection range. |
| 2 | TILT | Controls scanning direction. |
| 3 | FULL/HALF | Selects sounding area. |
| 4 | TARGET | Turns target lock on/off, or reverses scanning direction. |

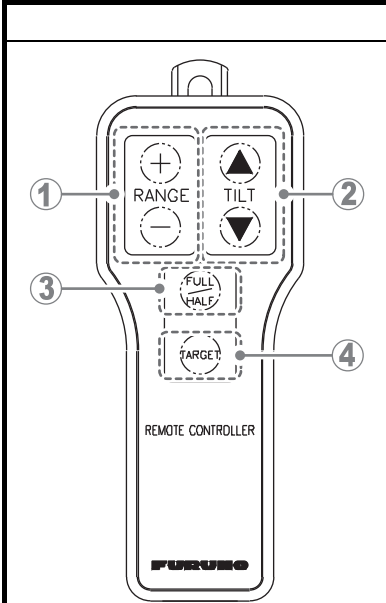

1.2 How to Turn the Power On/Off

1.2.1 How to turn the power on

Press the **POWER** key to turn on the system power. The key makes a “click” sound and the system releases a “beep” sound, the LED above the power switch lights up and the start-up screen appears. When the start-up process completes, the last used screen is displayed.

Note 1: When turning on the system, make sure that five seconds have passed from turning off the system.

Note 2: When language selection window appears, refer to the "How to Change the Displayed Language" on page 5-2.

1.2.2 How to turn the power off

It is recommended to retract the transducer before you turn the power off. Also, to avoid excessive stress on the hull unit's shaft, reduce your speed to below 15 knots before retracting the transducer.

1. Reduce speed to below 15 knots.
2. Press the **XDR up** key to raise the transducer. The XDR LED flashes to indicate that the transducer is moving. When retraction is complete, the LED stops flashing and lights steadily. You can also confirm the raise/lower status of the transducer on-screen, by checking the raise/lower indication at the top-right of the screen.

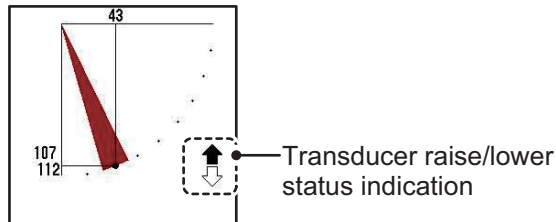

3. Confirm that the transducer is fully retracted, then press the **POWER** key until you hear a "click" sound, then keep the key pressed. A dialog box showing a countdown appears during the power-down process.

Note 1: If the transducer is not retracted before the power-down process, at the one-second-mark of the countdown the message "Retracting" appears and the system automatically raises the transducer. When the transducer is fully retracted, the power-down process is completed.

Note 2: For configurations with two CH-502/CH-602 control units, check that the control unit which turned the power on is used to turn the power off. If wrong controller is used, the system will not turn off.

Note 3: To avoid any damage to the transducer, always raise the transducer BEFORE you turn the power off. See section 1.3.

1.3 How to Raise/Lower the Transducer

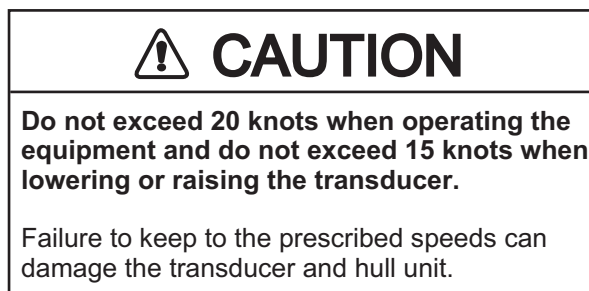

1.3.1 How to lower the transducer

When you reach your fishing ground, do the following:

1. Press the **XDR down** key () to lower the transducer. The lamp above the key flashes to indicate that the transducer is being lowered. When the transducer is completely lowered, the lamp lights steadily.

1. OPERATIONAL OVERVIEW

2. Check that the transducer status indicator on the display shows a filled down arrow.

1.3.2 How to raise the transducer

To raise the transducer, do the following:

1. Press the **XDR up** key () to raise the transducer. The lamp above the key blinks to indicate that the transducer is being raised. When the transducer is completely retracted, the lamp lights steadily.
2. Check that the transducer status indicator on the display shows a filled up arrow.

Note 1: If the automatic retraction feature is enabled, the system automatically raises the transducer once the ship exceeds the pre-set speed. If speed data is not accurate, the transducer may be raised at a different speed than the pre-set speed. For further details regarding automatic retraction, see section 5.15.

Note 2: When the ship exceeds the speed set at [SPEED ALARM/MESSAGE] in the [SYSTEM SETTING 2] menu, an audible alarm may sound. For further details see section 5.15

1.4 How to Adjust the Brilliance

You can adjust the brilliance for the display and the key panel backlights.

To adjust the brilliance, do the following:

1. Press the brilliance key (). The [BRILLIANCE] dialog box appears.

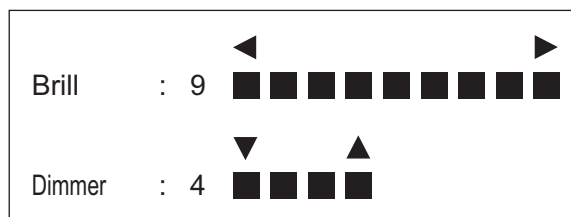

2. Press ◀ or ▶ on the Cursorpad to adjust the screen brilliance. The setting range is [0] to [9], default [9].
3. Press ▲ or ▼ on the Cursorpad to adjust the key panel brilliance. The setting range is [0] to [4], default [4].
4. Press the **MENU** key to apply the settings and close the menu.

Note 1: The dialog box disappears automatically if there is no operation within a few seconds.

Note 2: The brilliance for external monitors (other than the optional MU-150HD) cannot be adjusted from the control unit. Refer to the monitor's manual for the correct procedure.

Note 3: If the system is turned off with the brilliance at minimum setting, the screen may appear blank when next turned on. In this case, press the brilliance key several times to increase the brilliance.

1.5 How to Select a Display Mode











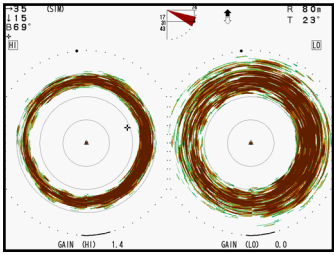

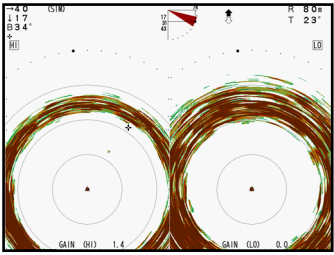

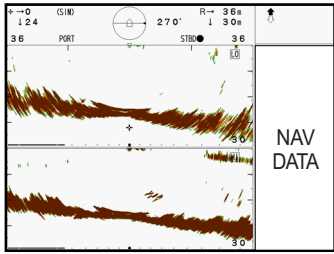
The CH-500/CH-600 has multiple display modes, all available at the push of a button. The figure below shows examples of the display mode buttons and their use.

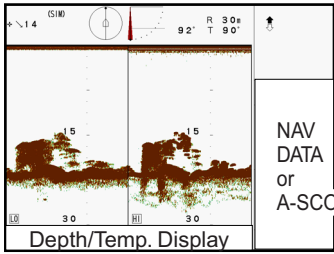
To select a display mode, press the appropriate button.

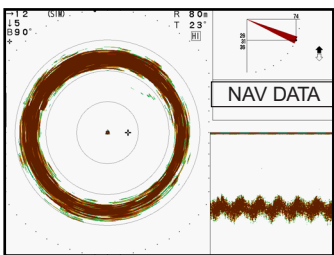
| Key | Display mode example | Key | Display mode example |
|-------------------|------------------------------|---|---|
| | <p>Horizontal</p> | | <p>Horizontal (zoomed)</p> |
| | <p>Vertical</p> | | <p>Echo Sounder (Fish finder)</p> |
| (CH-500 only) | <p>Horizontal + History</p> | (CH-500) + Choose (CH-600) | <p>Full-circle A-Scope + Horizontal</p> |
| (CH-500 only) | <p>Horizontal + Vertical</p> | (CH-500) + Choose (CH-600) | <p>Full-circle A-Scope</p> |
| | | | Window Control. Used only with Horizontal + Vertical & Horizontal + History display modes. No use in other modes. |

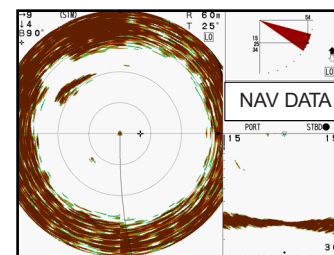
Selecting a Display Mode (only for the CH-600)

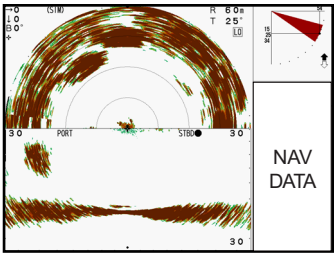
The following displays are available with the dual-frequency transducer.

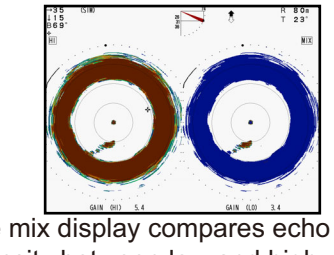
| Key | Display mode example | Key | Display mode example |
|---|--|---|--|
|  x2 |  DUAL-FREQ HORIZONTAL 360° dual-freq. display of fish echoes, etc. (Chapter 2) |  x2 |  DUAL-FREQ. HORIZ. EXPANSION Expansion of dual-freq. horizontal display. (Chapter 2) |
|  x2 |  DUAL-FREQ. VERTICAL SCAN Dual-freq. display of vertical section of fish echoes. Useful for judging depth and center position of fish school. (Chapter 3) |  x2 |  DUAL-FREQ. ECHO SOUNDER Dual-freq. display of fish echoes below vessel. (Chapter 4) |
|  + Choose  |  HORIZONTAL/HISTORY The horizontal picture appears in the main window; the history picture in the sub window. Useful for showing history of fish movement, distribution. |  + Choose  |  HORIZONTAL/VERTICAL SCAN The horizontal picture appears in the main window; the vertical fan picture in the sub window. |
|  + Choose  |  HORIZONTAL/VERTICAL ZOOM The horizontal picture appears in the main window; vertical zoom picture in the sub window. |  | Low frequency and high frequency can be changed with this key. |
|  |  MIX The mix display compares echo intensity between low and high frequencies, and displays echoes from tiny fish in discriminative colors. | | |

1.6 How to Adjust the Gain

The **GAIN** knob adjusts the sensitivity of the receiver, which can hide noise and other unwanted echoes. A high gain setting increases signal strength and can show excessive noise, as well as smaller, hard to detect echoes. A low gain setting eliminates noise and gives a clearer picture, however smaller echoes may also be removed.



1. Operate the **GAIN** knob and the gain setting dialog box appears at the bottom of the screen.

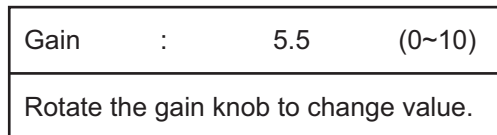

2. Turn the **GAIN** knob counter-clockwise to reduce the gain. Turn the **GAIN** knob clockwise to increase the gain.

Note: If [Gain Setting Protect] in the [System Setting 2] menu is set to [ON] and the **GAIN** knob is operated, the message "Press the gain knob to adjust the gain." appears. Press the **GAIN** knob, then adjust the gain as necessary.

1.7 How to Use the Menu

This section covers how to access the menu. For menu details, see chapter 5.

1. Press the **MENU** key. The menu window appears.

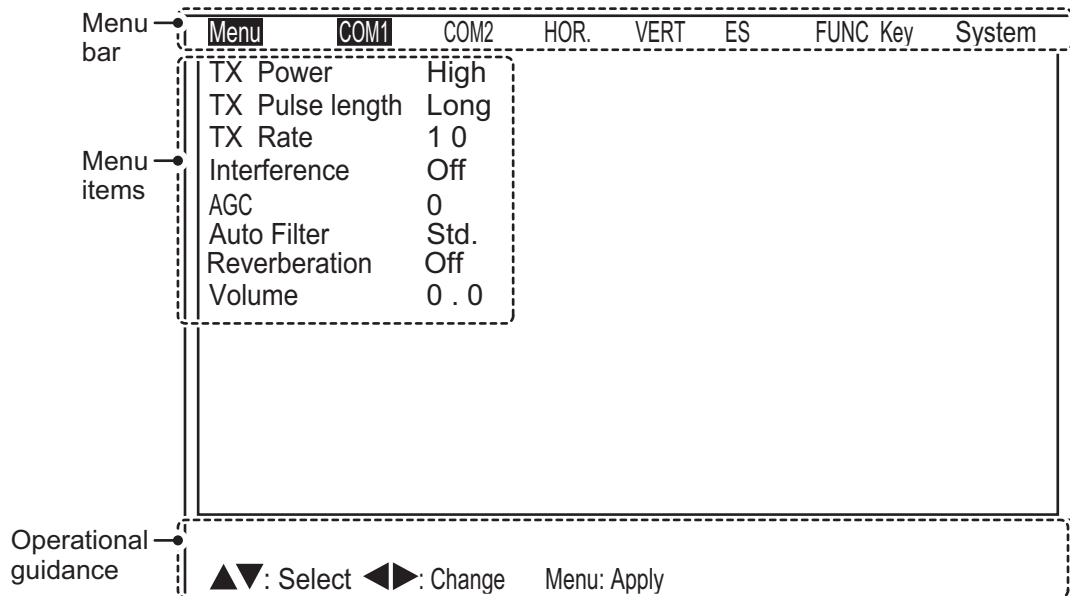

Note: The CH-600 can set [Interference], [AGC] and [Auto Filter] for LF and HF respectively.

2. Press ▲ to select the menu bar.
3. Press ◀ or ▶ to select a menu.
The selected item is highlighted. The example figure above shows the [COM1] menu and the menu title at the top of the screen is highlighted.
4. Press ▼ or ▲ to move the cursor inside the menu and select a menu item.
The guidance box at the bottom of the screen shows a brief explanation for the selected item and the operations allowed for the selected menu item.
The selected item is also highlighted in the same manner as described in step 3.
5. Press ◀ or ▶ to show the settings for the select menu item.
6. Press ◀ or ▶ to adjust or change the settings for the selected menu item.
7. To save and apply changes, press the **MENU** key.

Note: If you change a setting, then select a different menu item, the changes made to the first menu item are saved.

1.8 Noise and Interference

Ultrasonic noise and interference can make it difficult to see the echoes you want to see on the screen. Depending on the cause, your sonar can “adjust” the picture, either by suppressing noise and interference, or by changing the transmission rate.

The following sections cover the more common causes of noise and interference.

1.8.1 Sea Surface Reflections (Horizontal Mode)

When a tilt is set at a low angle, sea surface reflections cover a large area of the display, making it difficult to read.

To reduce sea surface reflections, set the tilt angle to 5° or higher so that the upper edge of the sonar beam does not hit the surface, or adjust the TVG.

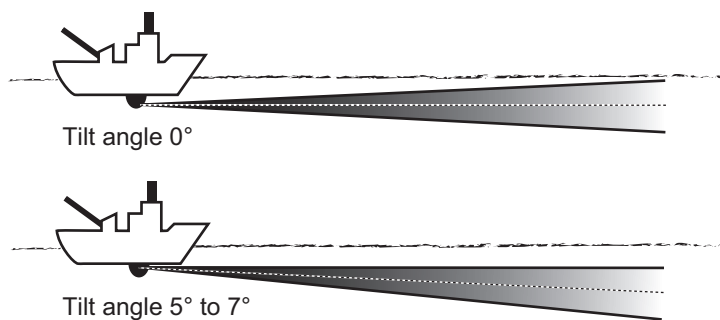

1.8.2 Wake Noise (Horizontal Mode)

The wake from own ship or other ships can cause “noise” which is shown as a dark reflection on-screen, when the tilt is at a low angle. The wake appears as a thick, continuous line and is easily distinguished from a fish school. However, because the air bubbles in the wake attenuate the sound beam, it is often difficult to “see” beyond the wake.

To avoid wake noise, wait until the wake has settled before checking the screen.

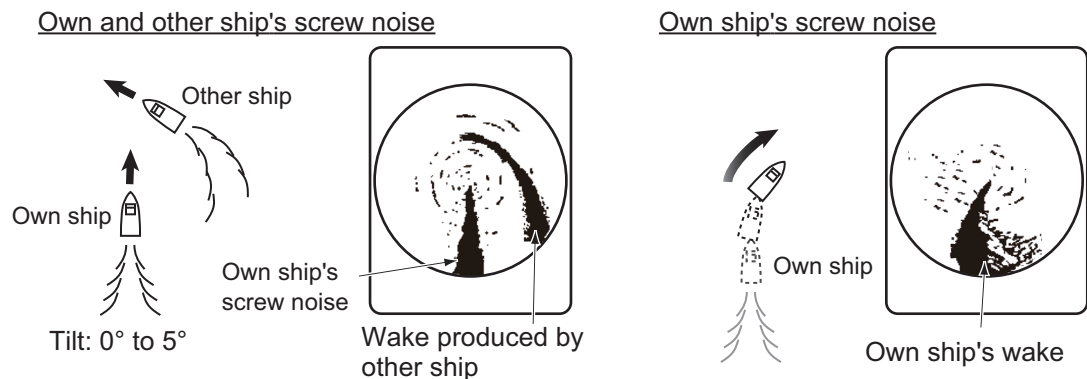

1.8.3 Sidelobe Echo/False Echo (Horizontal Mode)

While the ultrasonic wave is emitted only in the direction set by the **TILT** control, some emissions are directed outside the main beam. These are called sidelobes. The energy of the sidelobe is weak in comparison to the main beam, but when the water is relatively shallow and the seabed is hard, strong echoes are detected by the sidelobes. These “false” echoes appear on the display in a manner similar to that shown in the figure below.

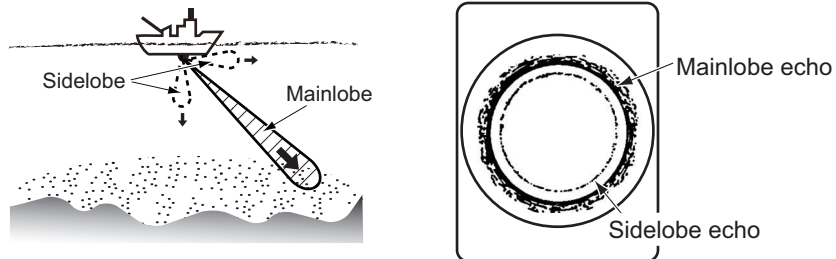

1.8.4 False Echo (Vertical Mode)

In shallow water (less than 100 m), unwanted echoes may appear. This phenomenon is caused by false echoes from the previous transmission.

Reducing [TX Rate] on the [COM1] menu may lessen this effect.

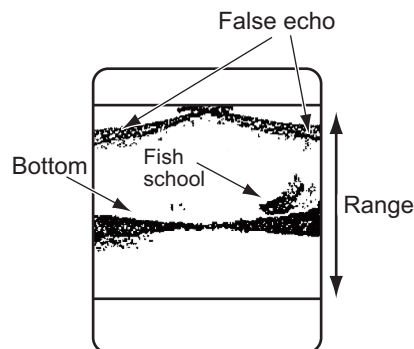

1.8.5 Interference from other equipment

While observing the sonar picture, you may encounter occasional or intermittent noise and interference. These are mostly caused by on-board electronic equipment, engine or propeller noise, or electrical noise from other sonars being operated nearby.

Typical interference is displayed on-screen in a manner similar to the figure below.

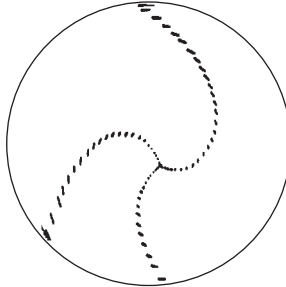

You can suppress this kind of interference by using the interference rejector.

To use the interference rejector, do the following:

1. Press the **MENU** key to open the menu.
2. Press **▲** to select the menu bar.
3. Press **▶** or **◀** to select [COM1].
4. Press **▼** to select [Interference], then press **▶** to show the [Interference] settings.
5. Press **▶** to select [On]. The interference rejector is now active. The IR indicator () is shown in the following location, depending on the display mode in use.
 - All Horizontal modes: Top-right of the screen.
 - Vertical and Echo Sounder modes: Top-left of the screen
6. Press the **MENU** key to close the menu and apply the changes.

To disable the interference rejector, repeat the above procedure and, at step 5, press **◀** to select [Off].

1.8.6 Interference from marine life

Marine life, such as plankton, can cause interference. The interference rejector can suppress this type of interference.

To use the interference rejector, see section 1.8.5.

1.8.7 How to erase weak echoes

Weak echoes caused by interference from surface reflection and plankton can be erased. This is particularly useful when you want to observe a school of fish clearly.

To erase weak echoes, do the following:

1. Press the **MENU** key to open the menu.
2. Press **▲** to select the menu bar.
3. Press **▶** or **◀** to select [COM2].
4. Press **▼** to select [Erase Color], then press **▶** to show the [Erase Color] settings. Depending on the setting for [Echo Colors] in the [COM2] menu, the number of colors available to erase changes.

| [Echo Colors] setting | [Erase Color] range available |
|-----------------------|---------------------------------|
| [32] | Off (no echoes erased), 1 to 30 |
| [16] | Off (no echoes erased), 1 to 14 |
| [8] | Off (no echoes erased), 1 to 6 |

The default setting for all [Echo Colors] settings is [Off].

5. Press **▶** to select the echo colors to erase. A higher settings erases stronger echoes.
To color bar changes each time you press **▶**, allowing to make sure only the colors you want to erase are removed.
Note: Use this function with caution. An excessively high setting can erase seabed echoes, which can lead to grounding and other safety problems.
6. Press the **MENU** key to close the menu and apply the changes.

1.9 How to Use the Cursor

Use the Cursorpad to move the cursor. The cursor indication shows information for the location of the cursor at all times and appears at the top-left corner of the display.

Depending on the display mode the following information can be displayed at the top-left of the screen.

- Horizontal display mode: horizontal distance from own ship, depth and bearing.
- Vertical display mode: horizontal distance from own ship and depth.
- Echo sounder display mode: depth from own ship.
- Full-circle A-scope display mode: horizontal distance from own ship, depth and bearing.

Note: When the cursor is placed on the own ship icon (center of the operational display area), the indications show a value of 0.

1.10 How to Adjust the Range

The **RANGE** knob adjusts the range for echo detection and display on all display modes. There are 15 preset ranges, for Horizontal, Vertical and Echo Sounder modes, which can be changed to suit your needs. The default preset range is the same for all modes, as shown in the table below.

CH-500

| Range setting | 60 kHz | | 88 kHz | | 150 kHz | | 180 kHz | | 240 kHz | |
|---------------|--------|------|--------|------|---------|------|---------|------|---------|------|
| | m | ft | m | ft | m | ft | m | ft | m | ft |
| 1 | 10 | 40 | 10 | 40 | 10 | 40 | 10 | 40 | 10 | 30 |
| 2 | 20 | 80 | 20 | 80 | 20 | 80 | 20 | 80 | 20 | 60 |
| 3 | 40 | 120 | 40 | 120 | 40 | 120 | 40 | 120 | 30 | 90 |
| 4 | 80 | 200 | 80 | 200 | 60 | 200 | 60 | 200 | 40 | 120 |
| 5 | 120 | 300 | 120 | 300 | 80 | 300 | 80 | 300 | 60 | 150 |
| 6 | 160 | 400 | 160 | 400 | 120 | 400 | 100 | 400 | 80 | 200 |
| 7 | 200 | 500 | 200 | 500 | 160 | 500 | 120 | 500 | 100 | 250 |
| 8 | 250 | 600 | 250 | 600 | 200 | 600 | 160 | 600 | 120 | 300 |
| 9 | 300 | 800 | 300 | 800 | 250 | 700 | 200 | 700 | 160 | 400 |
| 10 | 400 | 1000 | 400 | 1000 | 300 | 800 | 250 | 800 | 200 | 500 |
| 11 | 500 | 1500 | 500 | 1500 | 400 | 1000 | 300 | 1000 | 250 | 600 |
| 12 | 600 | 2000 | 600 | 2000 | 500 | 1500 | 400 | 1200 | 300 | 800 |
| 13 | 800 | 3000 | 800 | 3000 | 600 | 2000 | 500 | 1500 | 400 | 1000 |
| 14 | 1200 | 4000 | 1000 | 3500 | 800 | 2500 | 600 | 2000 | 500 | 1500 |
| 15 | 1600 | 5000 | 1200 | 4000 | 1000 | 3500 | 800 | 2500 | 600 | 2000 |

CH-600

| Range setting | 60/153 kHz, 85/215 kHz | |
|---------------|------------------------|------|
| | m | ft |
| 1 | 20 | 50 |
| 2 | 40 | 100 |
| 3 | 60 | 200 |
| 4 | 80 | 300 |
| 5 | 100 | 400 |
| 6 | 120 | 500 |
| 7 | 160 | 600 |
| 8 | 200 | 700 |
| 9 | 250 | 800 |
| 10 | 300 | 1000 |
| 11 | 400 | 1200 |
| 12 | 500 | 1500 |
| 13 | 600 | 2000 |
| 14 | 800 | 3000 |
| 15 | 1200 | 4000 |

To increase the range, turn the **RANGE** knob clockwise. To decrease the range, turn the **RANGE** knob counter-clockwise.

When the range is changed, the selected range is displayed at the top-center of the screen for a few seconds. The indication at the top-right of the screen always shows

the currently selected range. For normal use, the range should be set so that the seabed echo is at the bottom of the screen.

1.11 How to Use the Train Controls

The **TRAIN** knob selects the direction (bearing) in which the scan beam is output. The actual beam changes depending on the display mode currently in use.

- Horizontal display mode: Select the center direction (bearing) for the scanning beam.
- Vertical display mode: Select the bearing for the scanning beam.
- Echo sounder display mode: Select the direction for the sounding beam.

1.11.1 How to change the train direction

Typically, the train moves in a clockwise direction. On occasions where you want to reconfirm echoes, you can reverse the train direction.

To reverse the train direction, press the **REVERSE** button (⊕).

Each time the button is pressed, the indication "REVERSE" appears for approximately three seconds at the top of the echo display area, and the train is reversed.

Note: The train reverse function is not available for Echo Sounder mode.

1.11.2 Train controls for horizontal mode

You can change the center direction, or bearing, for the horizontal scanning beam. If you have a scanning sector set (see section 1.13), the center of the sector moves according to the train setting.

The train bearing moves in 6° steps and can be adjusted in the full 360° spectrum.

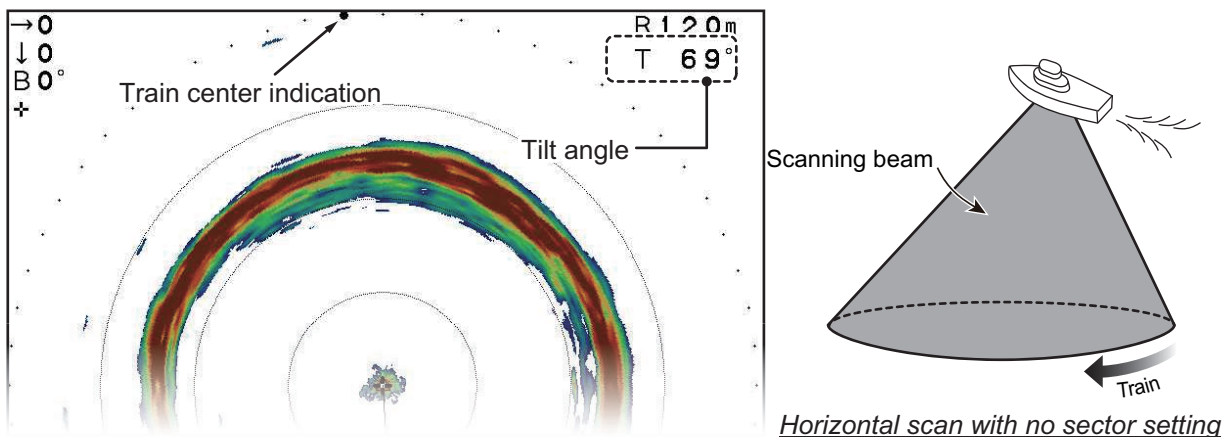

The train indicator (solid circle) moves to show the bearing graphically. The bearing indication at the top-left of the screen shows the bearing in degrees.

To increase the bearing, turn the **TRAIN** knob clockwise.

To decrease the bearing, turn the **TRAIN** knob counter-clockwise.

1.11.3 Train controls for vertical mode

In Vertical display mode, the scanning beam “swings” in an arc, within the preset sector (see section 1.13.2). The train control adjusts the bearing in which the scan beam “swings.”

The train angle moves in 6° steps and can be adjusted in the full 360° spectrum.

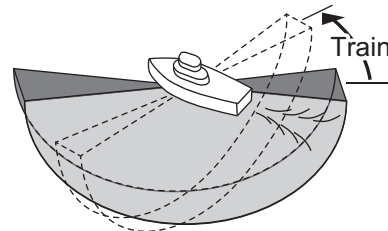
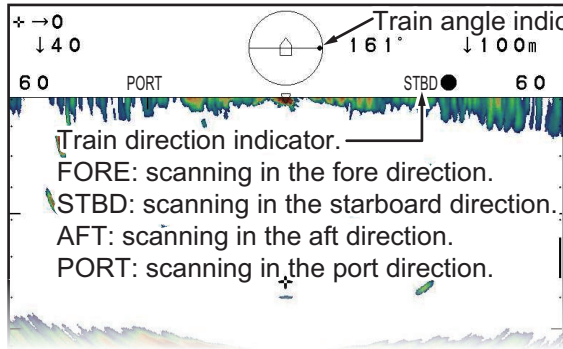

Vertical scan with no sector setting

The train angle indicator (solid circle) moves to show the starting direction of each scan.

To increase the bearing, turn the **TRAIN** knob clockwise.

To decrease the bearing, turn the **TRAIN** knob counter-clockwise.

1.11.4 Train control for echo sounder mode

In Echo Sounder display mode, the scanning beam is sent in the direction set with the **TRAIN** knob.

The train angle moves in 6° steps and can be adjusted in the full 360° spectrum.

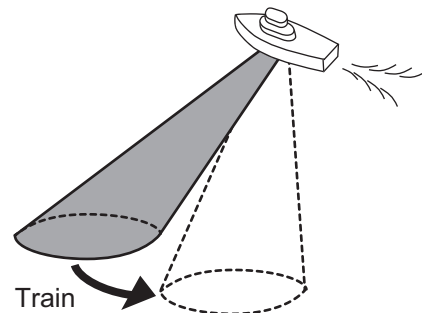
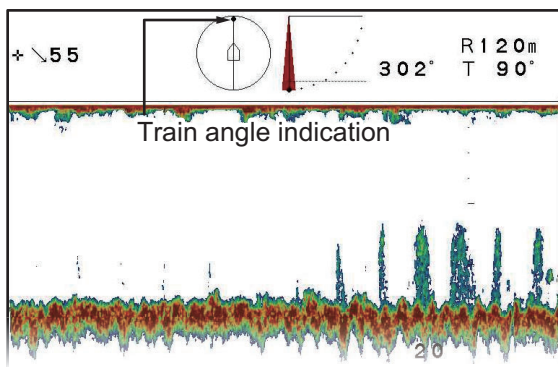

To move the scanning beam clockwise (in relation to your ship), turn the **TRAIN** knob clockwise.

To move the scanning beam counter-clockwise (in relation to your ship), turn the **TRAIN** knob counter-clockwise.

1.12 How to Use the Tilt Controls

You can adjust the tilt angle with the **TILT** knob. Depending on the display mode in use, the changing the tilt affects the echo differently.

The current tilt setting always appears at the top-center of the display, which gives you a clear image of the angle for the scan beam.

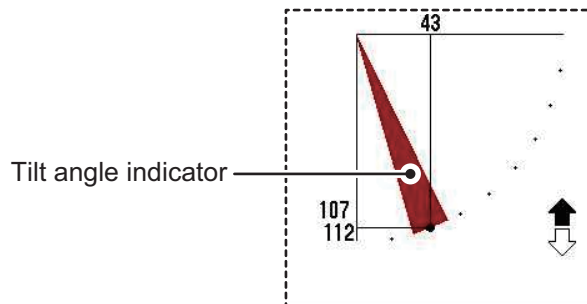

1.12.1 Tilt control for horizontal modes

The tilt angle is the direction in which the ultrasonic wave is emitted. A tilt angle of 0° is horizontal and an angle of 90° is vertical. You can change the tilt angle depending on your needs by using the **TILT** knob.

When the tilt angle is changed, the selected angle appears at the top-center of the screen for a few seconds. The selected angle is always visible at the top-right of the echo screen.

1.12.2 Tilt control for vertical mode

The tilt angle, in vertical mode, adjusts the angle for the beam center. A tilt angle of 0° is vertical and an angle of 90° is horizontal. You can change the tilt angle depending on your needs by using the **TILT** knob.

When the tilt angle is changed, the selected angle appears at the top-center of the screen for a few seconds. The selected angle is always visible at the top-right of the echo screen.

1.12.3 Tilt control for echo sounder mode

You can point the transducer in any direction between the bottom of the ship (90°) and to the front of the ship (0°).

To change the title angle, rotate the **TILT** control. The tilt is adjusted in 1° increments and the selected angle appears at the top-center of the echo display area for a few seconds.

1.13 How to Use the Sector Function

In some cases, you may want to restrict the scanning beam to a specific sector in relation to your ship. A sector is a “slice” of the full scanning range.

Depending on the display mode selected, the sector setting behaves in a different manner.

1.13.1 How to set and use a sector with horizontal mode

In Horizontal display mode, the **SECTOR** knob selects a preset width for the horizontally scanned sector.

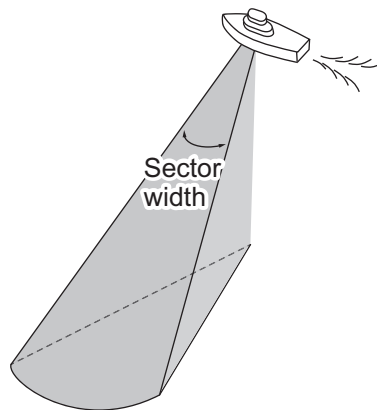

The setting range is 6° to 360° in 16 steps, as shown in the table below.

| Preset | 1 | 2 | 3 | 4 | 5 | 6 | 7 | 8 | 9 | 10 | 11 | 12 | 13 | 14 | 15 | 16 |
|------------------|---|----|----|----|----|-----|-----|-----|-----|-----|-----|-----|-----|-----|-----|-----|
| Sector Width (°) | 6 | 24 | 48 | 72 | 96 | 120 | 144 | 168 | 192 | 216 | 240 | 264 | 288 | 312 | 336 | 360 |

To increase the width, turn the **SECTOR** knob clockwise.

To decrease the width, turn the **SECTOR** knob counter-clockwise.

You can also alternate between full-range scan and half-range scan with the **FULL/HALF SECTOR** key .

The full-range scan shows 360° degree coverage around your ship and the half-range scan shows a 168° area in the train direction (see section 1.11.2 for details on horizontal train).

1.13.2 How to set and use a sector with vertical mode

In Vertical display mode, the **SECTOR** knob selects a preset width for the vertically scanned sector.

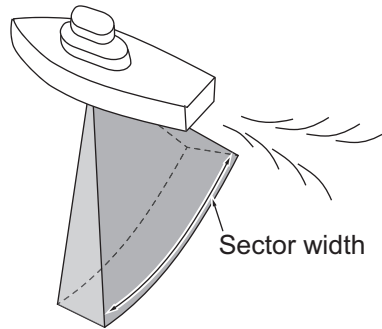

The setting range is 6° to 180° in 16 steps, as shown in the table below.

| Preset | 1 | 2 | 3 | 4 | 5 | 6 | 7 | 8 | 9 | 10 | 11 | 12 | 13 | 14 | 15 | 16 |
|------------------|---|----|----|----|----|----|----|----|----|-----|-----|-----|-----|-----|-----|-----|
| Sector Width (°) | 6 | 12 | 24 | 36 | 48 | 60 | 72 | 84 | 96 | 108 | 120 | 132 | 144 | 156 | 168 | 180 |

To increase the width, turn the **SECTOR** knob clockwise.

To decrease the width, turn the **SECTOR** knob counter-clockwise.

You can also alternate between full-range scan and half-range scan with the **FULL/HALF SECTOR** key .

The full-range scan shows 180° degree coverage around your ship and the half-range scan shows a 84° area in the train direction (see section 1.11.3 for details on vertical train).

1.13.3 How to set a sector center (vertical mode only)

The scanned sector can be moved within the 180° scanning range, with the **TILT** knob.

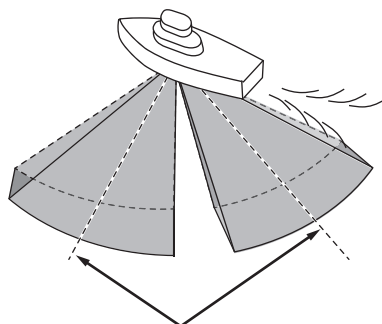

Sector center (TILT)

The tilt function's setting range is 0° (starboard side of the ship) to 180° (port side of the ship), in 6° increments.

Select the tilt setting which places the sector center at the middle of the detection range.

Automatic shift for own ship

The tilt function automatically shifts your ship position on the screen, in relation to the direction of the sector center.

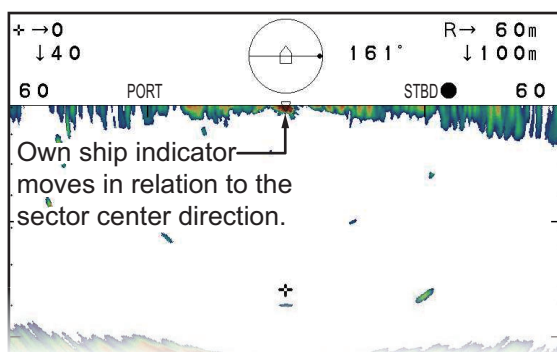

The directional indications for [FORE], [AFT], [STBD] and [PORT] are hidden when the own ship indicator is in that direction, as shown below.

- Sector center set between 0° and 60°: Own position shifted to port/aft, indication for port/aft is hidden.
- Sector center set between 66° and 114°: Own position shifted to center, all directional indications visible.
- Sector center between 120° and 180°: Own position shifted to fore/starboard, indication for fore/starboard is hidden.

1.14 How to Use the Event Marker

The event marker function marks important locations on the display, and up to five markers may be inscribed. This function requires connection to speed and positions sensors. When [TLL Output] is set to [ON], the CH-600 outputs event mark information to the external navigational equipment such as a gyrocompass, a GPS receiver and



so on. Press  key to output own ship information from NMEA2000 port.

The procedure to inscribe an event mark is the same for all display modes.

1.14.1 How to inscribe an event mark

To inscribe an event mark, move the cursor to the location to mark, then press the

EVENT key .

Each time the **EVENT** key is pressed, the latest event mark icon () appears at the cursor location. All previous marks are displayed with the previous event mark icon (.

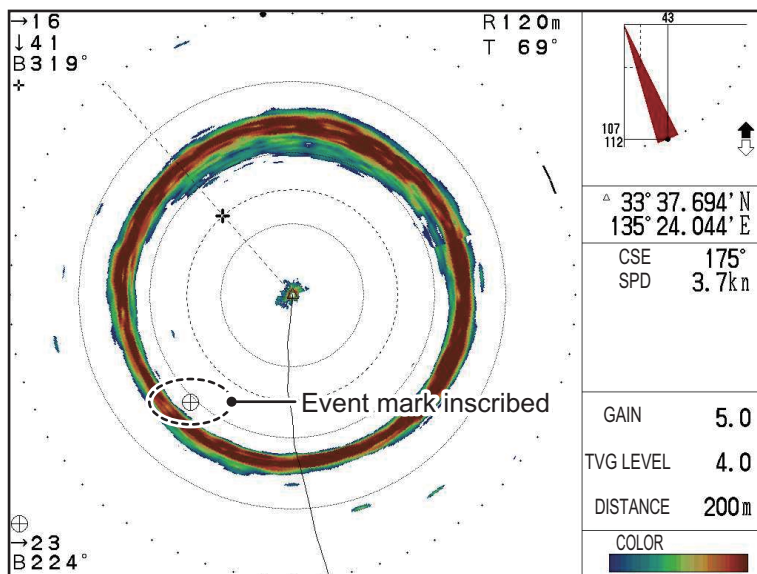

When the capacity for event marks is reached, the oldest mark is erased to make room for the newest mark.

Note 1: For Horizontal and Full-circle A-scope display modes, the range and bearing for the latest event mark is displayed at the bottom-left of the screen.

Note 2: Where Horizontal + Cross-Section display mode is in use, event marks can only be inscribed in the main window.

1.14.2 How to delete event marks

To delete all event markers, do the following:

1. Move the cursor outside the echo display area.
2. Press the **EVENT** key. All event marks are removed from the display.

Note 1: If a function key is set as a short-cut key for [DELETE MARK], you can also use the assigned function key to delete the event marks.

Note 2: Event markers cannot be deleted individually.

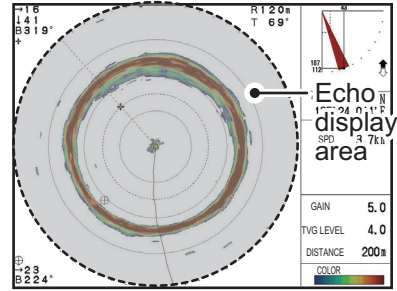

1.15 How to Use the Range/Bearing Marker

The range and bearing marker function is used to measure the range (distance) and bearing from your ship to a specified location on the display, such as a fish school or a reef.

The range marker behaves differently depending on the display mode in use. See the following display examples for details.

To show an range mark, press the **RANGE** key . The range mark moves with the cursor. Move the cursor to the location to be measured.

Depending on the display mode in use, the range mark is displayed in a different manner, and measurements also differ.

Horizontal display mode

The cursor location indicator shows the range (horizontal), depth and bearing to the cursor location. The train indication also shows the range (horizontal) and range to the cursor as a dashed line.

The range ring and bearing line move with the cursor.

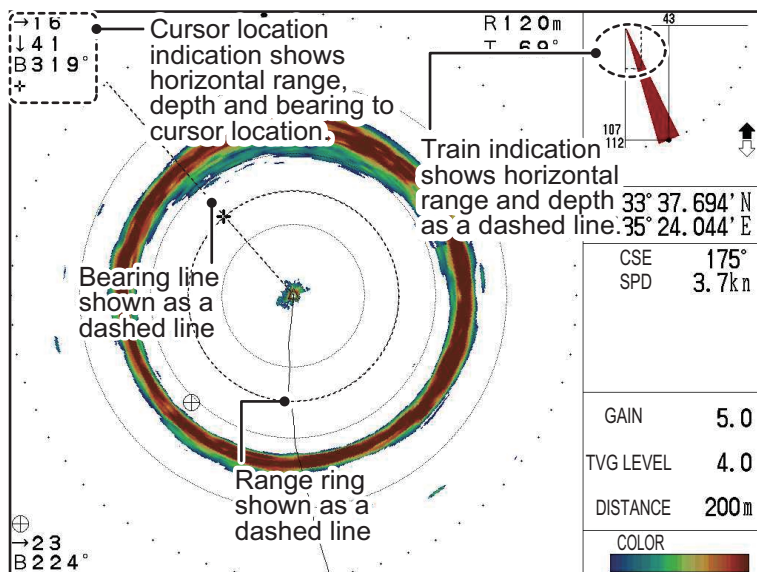

1. OPERATIONAL OVERVIEW

Full-circle A-Scope display mode

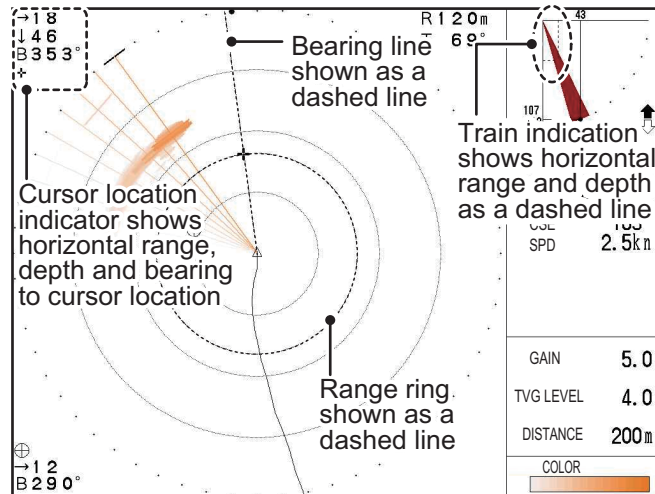

Vertical display mode

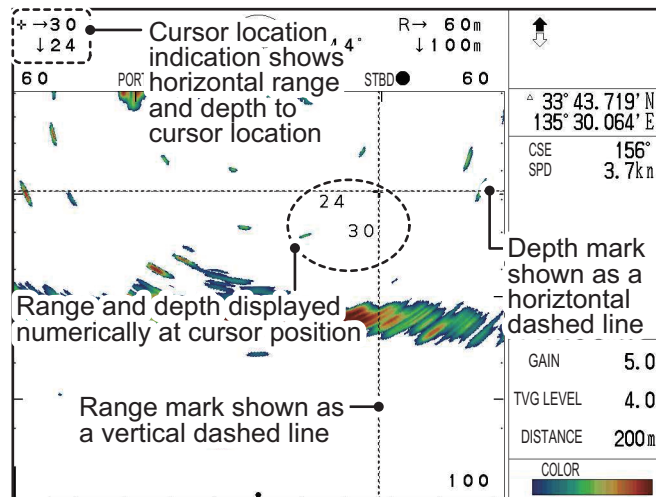

Echo sounder display mode

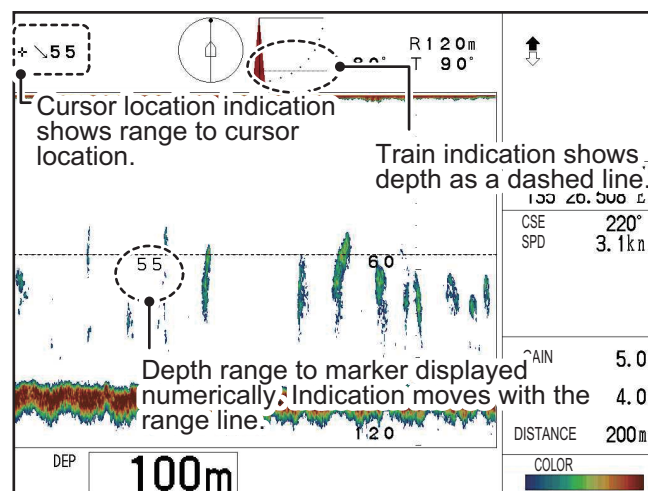

1.16 How to Use the Tracking Function

The **Tracking** button () allows you to track a fixed position, a fish school or re-scan an area in reverse.

There are three types of tracking methods available.

- **[Position]**: Tracks a stationary position (for example, a reef) using position data from a navigator. This tracking type is available for Horizontal, Horizontal (zoomed) and Full-circle A-Scope modes only.
- **[Echo]**: Tracks fish echoes either manually, or automatically. This tracking type is available for Horizontal mode only. This is the default setting.
- **[Reverse]**: Reverses the train direction manually. This tracking mode is available for all Horizontal modes. In Vertical mode, this function works the same as the Train reverse function (see section 1.11.1).

Note 1: The tracking function is not available for Echo Sounder mode.

Note 2: [Position] and [Echo] tracking are not available for Vertical mode. If Vertical mode is active and the tracking method is set to either [Position] or [Echo], the method is automatically changed to [Reverse] for Vertical mode.

1.16.1 How to select the tracking method

To select the tracking method to use, do the following:

1. Press the **MENU** key to open the menu.
2. Press **▶** or **◀** to select [HOR.].
3. Press **▼** to select [Tracking Key], then press **▶** to show the [Tracking Key] settings.
4. Press **▶** or **◀** to select [Position], [Echo] or [Reverse], as appropriate. The default setting is [Echo].
5. Press the **MENU** key to close the menu and apply the changes.

1.16.2 Position tracking function

The position tracking function requires position data input from a navigator. This tracking method is available for all Horizontal modes.

1. Referring to section 1.16.1, set the tracking method to [Position].
2. Place the cursor at the location to track, then press the **Tracking** button. The system now tracks the selected location.

Note 1: When Position tracking is in use, the following controls are disabled.

- Tilt
- Sector
- Train
- Range

If one of the disabled controls is operated, the notification "Target tracking on. Stop tracking." appears.

Note 2: If the **Tracking** key is pressed and no data is input from a navigator, the notification "No position data." appears.

Note 3: When position tracking is active, the scan sector is fixed at 48° width in the direction of the tracked position.

To stop position tracking, press the **Tracking** key again.

1.16.3 Echo tracking function

The echo tracking function can be set to tracks fish echoes either automatically or manually.

How to setup echo tracking

1. Referring to section 1.16.1, set the tracking method to [Echo].
2. At the [HOR.] menu, press ▼ to select [Tracking Mode], then press ►. The [Tracking Mode] settings appear.
3. Select [Auto] or [Manual], as appropriate.
4. Press the **MENU** key to close the menu and apply the changes.

How to use automatic echo tracking

1. Confirm that the [Tracking Mode] is set to **Auto**, then press the **Tracking** key. The detection area setup window appears.

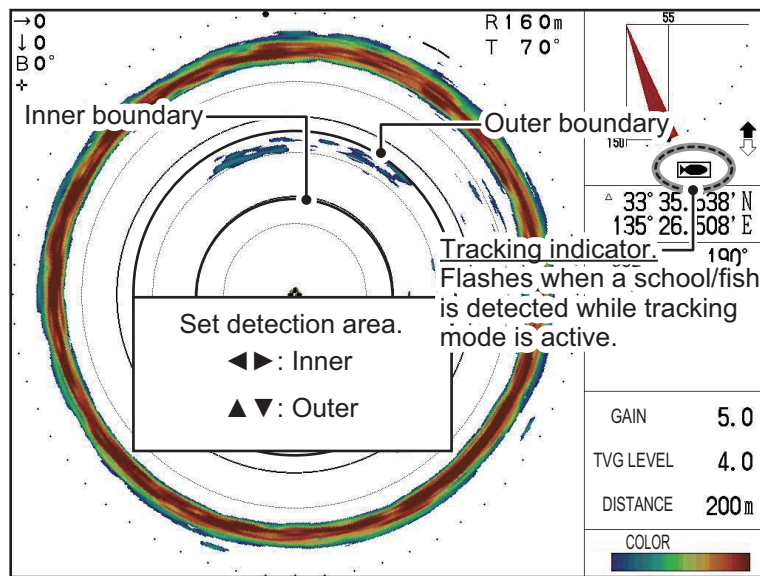

2. Press ◀ or ▶ to adjust the inner boundary area.
3. Press ▲ or ▼ to adjust the outer boundary area.

Fish detected between the inner boundary and outer boundary are tracked automatically. When fish are detected, the system release a notification sound, the tracking indicator flashes and the train direction changes to rescan the area. The area is “re-painted” where the echoes were detected.

The detection area is affected by both sector and train direction settings. In the example to the right, a scan sector with a width of 192° is set with the train direction set to 180° (in the FORE direction).

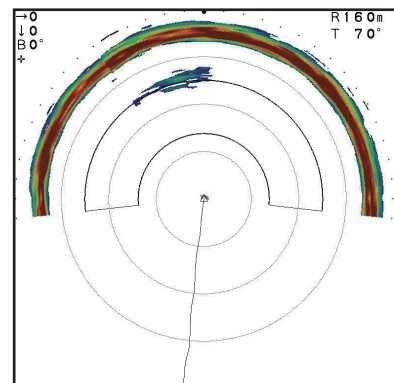

1.16.4 Reverse tracking function (Horizontal mode only)

You can manually change the train direction at any time. This allows you to re-check an area that was recently swept. This tracking method is available for all Horizontal modes and the Vertical mode.

1. Referring to section 1.16.1, set the tracking method to [Reverse].
2. To reverse the train direction, press the **Tracking** button. The train now moves in reverse.

Each time the button is pressed, the indication "REVERSE" appears for approximately three seconds at the top of the echo display area, and the train is reversed.

Note: You can also change the train direction with the **REVERSE** button ()

1. OPERATIONAL OVERVIEW

This page is intentionally left blank.

2. HORIZONTAL MODE

2.1 Operational Overview

The Horizontal Scan displays a broad view of the waters beneath and around your vessel.

For CH-500

Five types of Horizontal display mode are available.

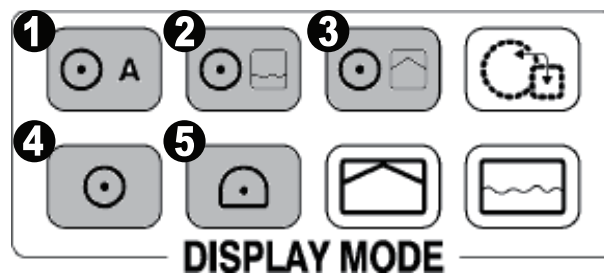

| Number | Display mode |
|--------|--|
| 1 | Full-circle A-Scope, Horizontal + Full-circle. |
| 2 | Horizontal + History. |
| 3 | Horizontal + Vertical. |
| 4 | Horizontal. |
| 5 | Horizontal (zoomed). |

Depending on your requirements, select the appropriate Horizontal display mode.

For CH-600

Three types of Horizontal display mode available.

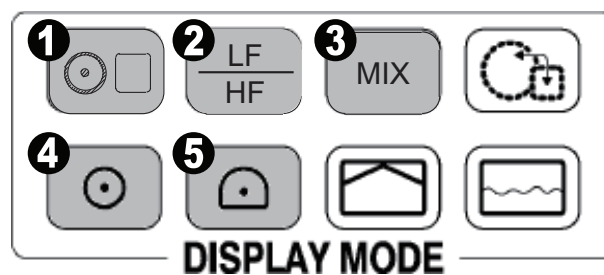

| Number | Display mode |
|--------|------------------------------------|
| 1 | Combination key |
| 2 | Switching the Frequency (LF or HF) |
| 3 | Mix Display |
| 4 | Horizontal. |
| 5 | Horizontal (zoomed). |

2.2 Horizontal Menu Overview

The [HOR.] (Horizontal) menu contains the settings and adjustments for Horizontal mode.

To access the [HOR.] menu, do the following:

1. Press the **MENU** key to open the menu.
2. Press **▲** to select the menu bar.
3. Press **▶** or **◀** to select [HOR.]. The Horizontal menu appears.

| Menu | COM1 | COM2 | HOR. | VERT | ES | FUNC Key | System |
|---------------|------|------|-------------|------|----|----------|--------|
| TVG Level | | 4.0 | | | | | |
| TVG Distance | | 4.0 | | | | | |
| Gain ADJ. | | 0 | | | | | |
| RES. Color | | LOG | | | | | |
| Clutter | | 0 | | | | | |
| Tracking Key | | Echo | | | | | |
| Tracking Mode | | Auto | | | | | |
| Auto Tilt | | Off | | | | | |
| A-Scope | | Off | | | | | |

▲▼: Select ◀▶: Change Menu: Apply

Note: The CH-600 can set [TVG Level], [TVG Distance], [Gain ADJ.], [RES. Color] and [Clutter] for LF or HF respectively.

The table below lists the menu items with a brief explanation, along with the settings and ranges available.

| Menu item | Description | Settings/Ranges |
|----------------|---|---|
| [TVG Level] | Time Varied Gain. Compensates for propagation loss of sound in water. See section 2.13.3. | 0.0 to 10.0; default: 4.0 |
| [TVG Distance] | Time Varied Gain. Compensates for propagation loss of sound in water. See section 2.13.3. | 0.0 to 10.0; default: 4.0 |
| [Gain ADJ.] | Adjust the level of gain. | -10 to +10; default: 0 |
| [RES. Color] | Sets the color scheme for echo display, based on echo strength. <ul style="list-style-type: none"> • LOG: Weak to strong echoes are displayed in colors respective to their echo strength. • Linear: Downplays weak echoes, compared to LOG. Effective for suppressing weak echoes such as plankton. • Square: Strong echoes are emphasized more than in Linear. • Cube: Strong echoes are emphasized even more than in Square. | LOG, Linear, Square, Cube; default: LOG |
| [Clutter] | Suppresses low intensity echoes, such as sediment. The higher the number (setting) the weaker the echoes which are erased. | 0, 1, 2, 3; default: 0 |

| Menu item | Description | Settings/Ranges |
|-----------------|---|--|
| [Tracking Key] | Set the function for the tracking key. See section 1.16.1. | Position, Echo, Reverse; default: Echo |
| [Tracking Mode] | Selects the tracking mode for [Echo] tracking. See section 1.16.3. | Auto, Manual; default: Auto |
| [Auto Tilt] | Enables/disables automatic tilt and tilt angle. For example, if the tilt is set to 30° and [Auto Tilt] is set to 4°, the tile changes as follows: 30°→26°→30°→34°→30°... | Off, ±2°, ±4°, ±6°, ±10°; default: Off |
| [A-Scope] | Enables/disables the A-Scope for Horizontal mode. | Off, On; default: Off |

2.3 Mix Display (CH-600 only)

The mix display compares echo intensity between low and high frequencies, and displays echoes from tiny fish in discriminative colors. This is done by utilizing the fact that tiny fish return a stronger echo against a high frequency rather than a low frequency. The equipment accomplishes this as follows:

- If a high frequency echo is stronger than the corresponding echo on the low frequency, the high frequency echo is displayed.
- If the low frequency echo is stronger than or equal to the high frequency echo, it is less likely to be a tiny fish and therefore is displayed in blue.

In other words, the echoes displayed in orange through light-blue may be considered to be tiny fish such as whitebait. When the mix display is active the indication MX appears at the top of the display.

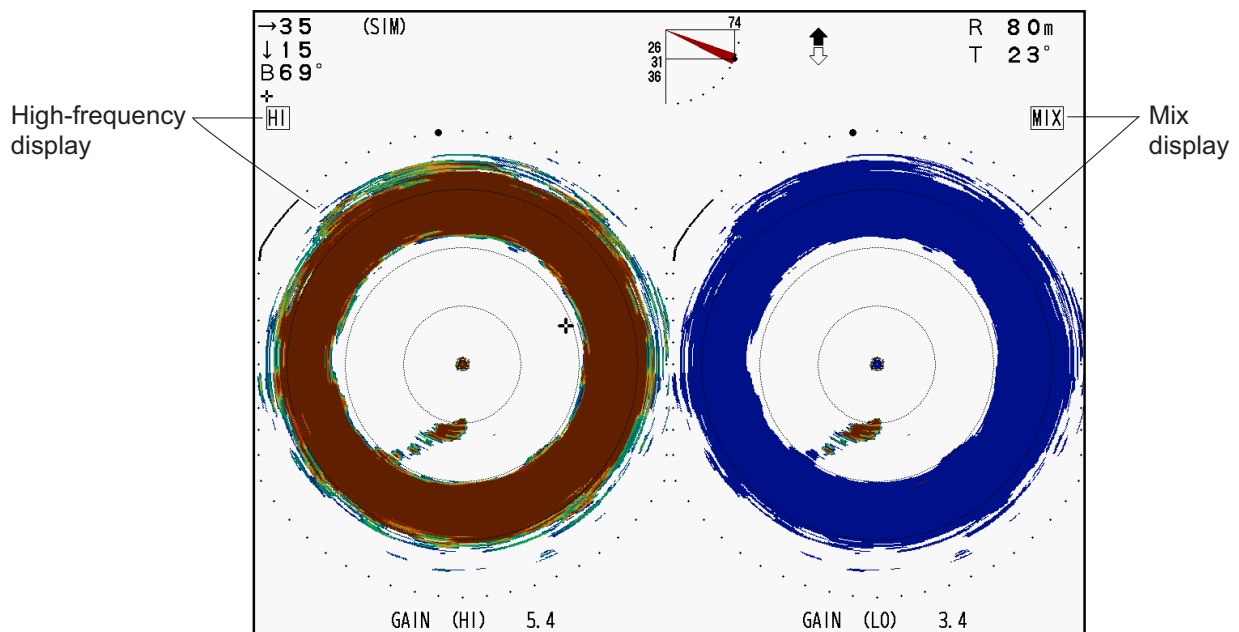

How the mix display works

To use the mix display effectively, it is important that the gain for both the low and high-frequencies is set properly. When searching for young fish such as whitebait, follow the procedure below. For detailed information about gain adjustment, see the next section.

2. HORIZONTAL MODE

1. Press the **MIX** key to activate the mix mode. How to display the mix display depends on the display mode in use.
2. Adjust the high-frequency gain while observing targeted fish.
3. While observing the mix display, set the low-frequency gain to 0 and gradually raise it just until echoes from adult fish disappear from the mix display.
4. While observing the echoes from young fish on the mix display, readjust the low-frequency gain in order to distinguish young fish. When the echoes from young fish are weak, lower the low-frequency gain. If adult fish appear, raise the low-frequency gain. (Rule of thumb: For whitebait, low-frequency gain is set 3-4 steps lower than high-frequency gain.)

Single-frequency display or combination display (other than vertical scan combination): Use the **MIX** key to switch between the mix display and the single-frequency display alternately.

Dual-frequency display: Use the **MIX** key to switch between the mix display and the dual-frequency display alternately.

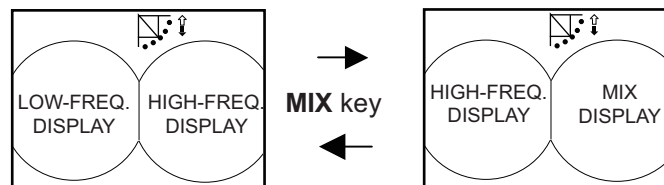

How the MIX key works in dual-frequency mode

Combination display (vertical scan combination) Main window is active: The **MIX** key changes the frequency of the main window from low to high alternately.

Sub window is active: The **MIX** key changes the frequency of the sub window from low to high alternately. To switch between main and sub windows use the **MAIN/SUB** key.

2.4 Typical Horizontal Mode

The Horizontal mode scans a 360° area below the ship, which makes it useful for general searches.

To view this display mode, press  .

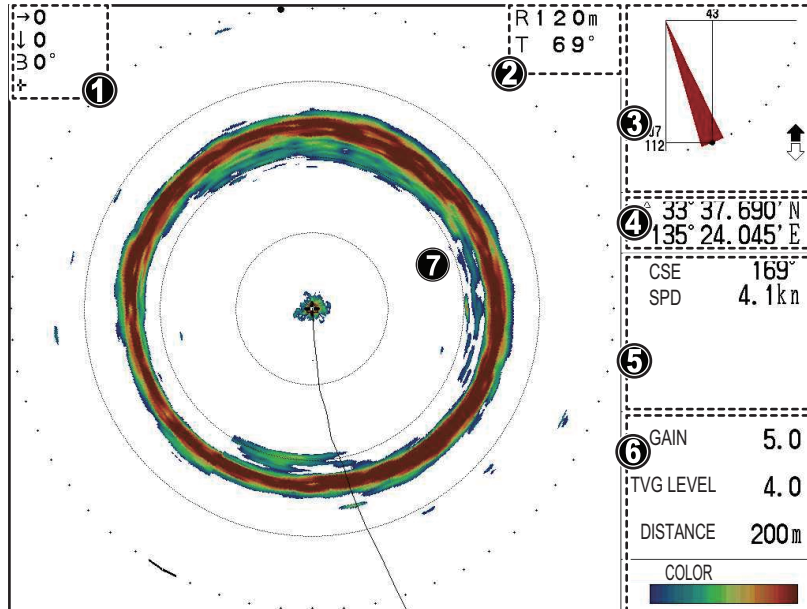

| Number | Description |
|--------|---|
| 1 | Indications for cursor position. (Horizontal distance, depth and bearing.) |
| 2 | Indications for range and tilt. |
| 3 | Indications for tilt angle, interference rejection, target lock and transducer raise/lower status. |
| 4 | Own ship or cursor position (latitude/longitude). Note: Requires connection to appropriate sensors. |
| 5 | Navigational data. (Heading, speed, depth, water temperature, tidal current information.) Note: Requires connection to appropriate sensors. |
| 6 | Echo display settings. (Gain, TVG level, distance.) |
| 7 | Horizontal scan echo display area. |

You can also customize this display to show the A-Scope readings in the data display section at the right-side of the screen.

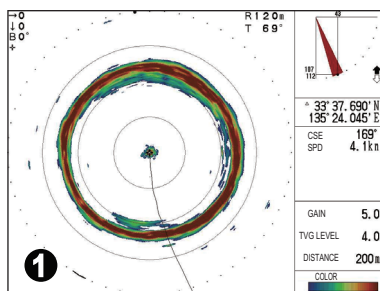

1 Typical Horizontal mode

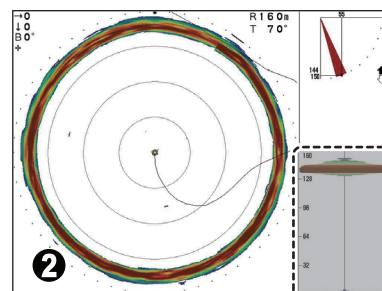

2 A-Scope enabled (hatched area)

2. HORIZONTAL MODE



In the above example, figure 1 shows a typical Horizontal mode display. Figure 2 shows the Horizontal mode with A-Scope (shown in the bottom-right of the screen example) enabled.

To activate the A-Scope display in Horizontal mode, do the following:

1. Referring to section 2.2, access the [HOR.] menu.
2. Press ▼ to select [A-Scope], then press ► to show the [A-Scope] settings.
3. Press ► or ◀ to select the appropriate setting.
Select [Yes] to show the A-Scope, or select [No] to hide the A-Scope.
4. Press the **MENU** key to close the menu.

2.5 Full-circle A-Scope Mode

Full-circle A-scope mode shows a 360° view of echoes at each transmission with amplitudes and tone proportional to their intensities. This makes it useful for estimating the kind of fish school and seabed composition.

When using the CH-500, press  to view this display mode. When using the CH-600, press  and select  Full A-Scope to view this display mode.

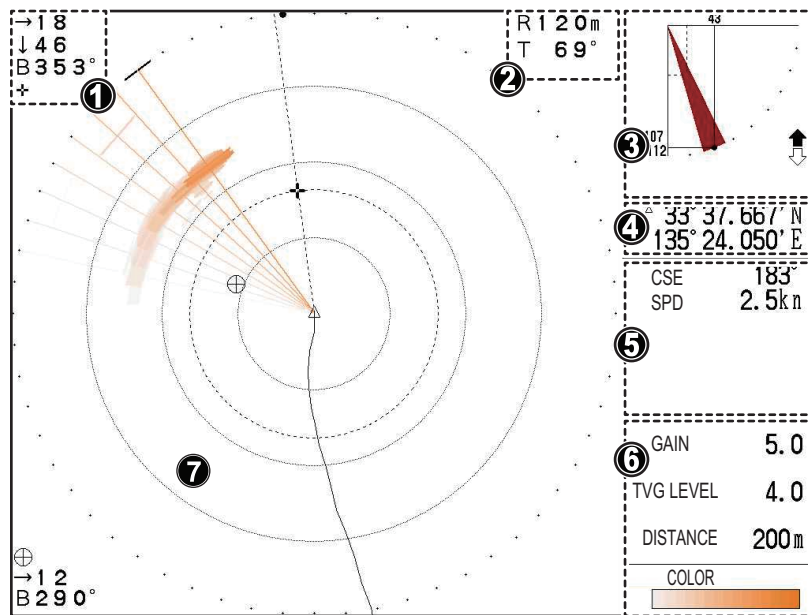

| Number | Description |
|--------|--|
| 1 | Indications for cursor position. (Horizontal distance, depth and bearing.) |
| 2 | Indications for range and tilt. |
| 3 | Indications for tilt angle, interference rejection, target lock and transducer raise/lower status. |
| 4 | Own ship or cursor position (latitude/longitude). Note: Requires connection to appropriate sensors. |
| 5 | Navigational data.(Heading, speed, depth, water temperature, tidal current information.) Note: Requires connection to appropriate sensors. |
| 6 | Echo display settings. (Gain, TVG level, distance.) |

| Number | Description |
|--------|--|
| 7 | Full-circle A-Scope echo display area. |

When Full-circle A-Scope mode is active, you can toggle the display between Full-circle A-Scope only and a “dual” display which show both the Full-circle A-Scope and the horizontal scan echoes.

By using the Horizontal + Full-circle A-Scope, you can compare the two displays and better estimate the density and distribution of fish schools.

To toggle the display, press . The display switches between Full-circle A-Scope only and the “dual” display with each press of the button.

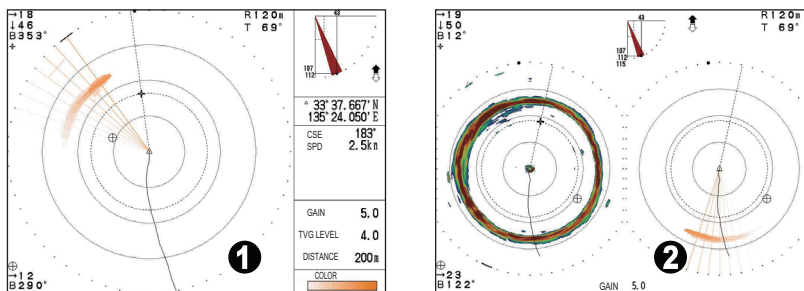

In the above example, figure 1 shows the Full-circle A-Scope display. Figure 2 shows the Horizontal + Full-circle A-Scope mode display.

When using the CH-600, press  and select [HOR./Full A-Scope].

2.6 Horizontal Mode (Zoomed)

Fish echoes may be enlarged by 1.5 times by using the Horizontal (zoomed) mode.

To view this display mode, press .

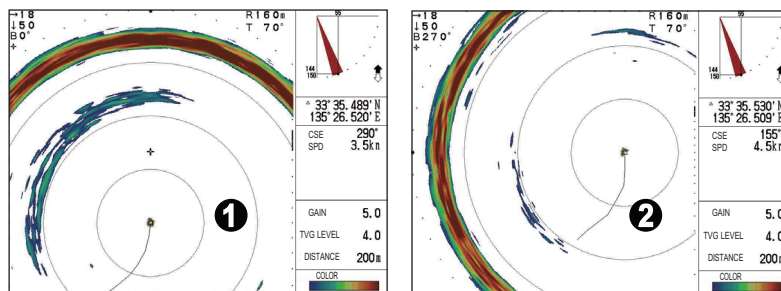



Depending on the training direction when this display mode is activated, the train center is automatically moved as shown in the table below.

| Training direction | Position after zoom is enabled | Remarks |
|--------------------|---|-----------------------------|
| 318° to 42° | Bottom of screen (Example figure 1) | For viewing forward. |
| 48° to 132° | Left side of screen | For viewing starboard side. |
| 138° to 222° | Top of screen | For viewing aft. |
| 228° to 312° | Right side of screen (Example figure 2) | For viewing port side. |

2.7 Horizontal + History Mode

The Horizontal + History mode shows both the Horizontal scan echoes and a view of the past horizontal scan echoes on one screen. This mode is best used to estimate the size and distribution of schools.

When using the CH-500, press  to view this display mode.

When using the CH-600, press  and select  HOR./Full A-Scope to view this display mode.

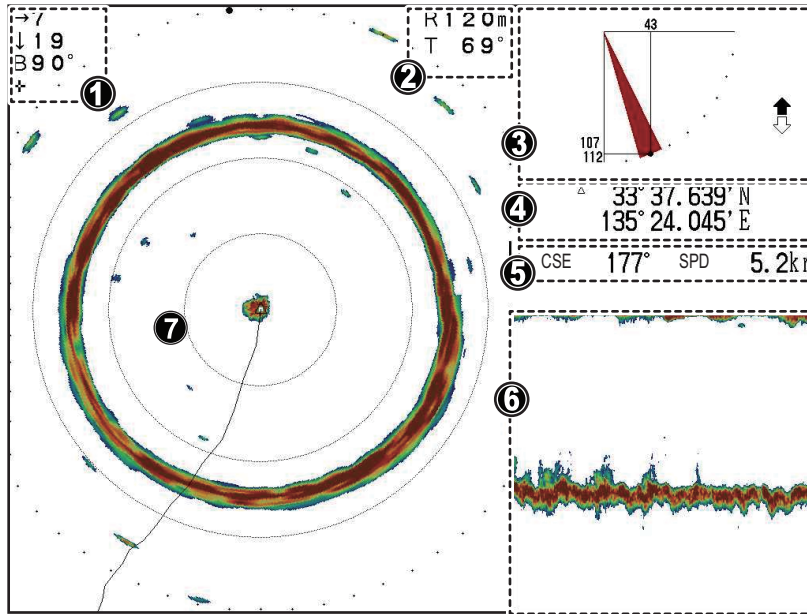

| Number | Description |
|--------|---|
| 1 | Indications for cursor position. (Horizontal distance, depth and bearing.) |
| 2 | Indications for range and tilt. |
| 3 | Indications for tilt angle, interference rejection, target lock and transducer raise/lower status. |
| 4 | Own ship or cursor position (latitude/longitude). Note: Requires connection to appropriate sensors. |
| 5 | Navigational data.(Heading and speed.) Note: Requires connection to appropriate sensors. |
| 6 | History display area. |
| 7 | Horizontal scan echo display area. |

2.8 Horizontal + Vertical Mode

With the Horizontal + Vertical display mode you can show both horizontal and vertical echoes in one of two manners.

The default display mode shows both a horizontal (360° around the ship) view in the main section of the display and a vertical (cross-section) scan of the waters below the ship at the bottom-right of the screen.

The split-screen display shows the horizontal (180° in the train direction) view at the top half of the screen and a vertical (cross-section) scan of the waters below the ship at the bottom half of the screen.

This mode is best used to estimate the size, location in relation to the seabed and distribution of schools which are both below and around the ship.

The split display also gives you a better idea of where your net is in relation to the boat.

When using the CH-500, press  to view this display mode.

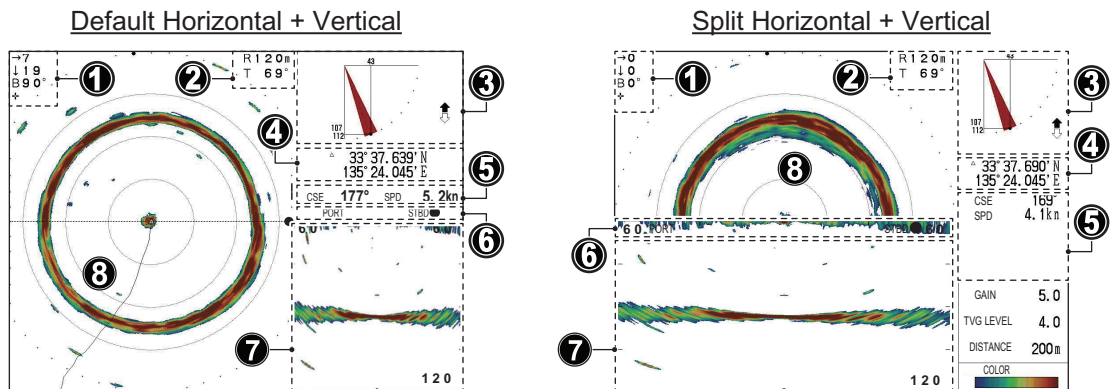

| Number | Description |
|--------|--|
| 1 | Indications for cursor position. (Horizontal distance, depth and bearing.) |
| 2 | Indications for range and tilt. |
| 3 | Indications for tilt angle, interference rejection, target lock and transducer raise/lower status. |
| 4 | Own ship or cursor position (latitude/longitude). Note: Requires connection to appropriate sensors. |
| 5 | Navigational data.(Heading, speed, depth, water temperature, tidal current information.) Note: Requires connection to appropriate sensors. |
| 6 | Scan direction (PORT, STBD, FORE, AFT). |
| 7 | Vertical scan echo display. (Sub window) |
| 8 | Horizontal scan echo display area. (Main window) |

How to use the window control button

The window control button switches control of the main (Horizontal scan) and the sub (vertical scan) windows. The displays are independent of each other, so you can adjust them as desired.

Press  to switch window control of the main and sub windows.

Where the sub window is selected, the sub window is highlighted in red and the message "Sub window controllable." appears.

Where the main window is selected, the message "Main window controllable." appears.

2.9 How to Choose a Frequency (CH-600 only)

2.9.1 Choosing the frequency

You may choose low frequency or high frequency, with the **LF/HF** key. The display shows HI or LO at the top of the screen depending on your selection. Use the table below to determine which frequency to use.

| Item | Low frequency | High frequency |
|--|--|---|
| Detection range | Longer range comparing with the high frequency. Attenuation loss is small on low frequency. | Shorter range comparing with the low frequency. Attenuation loss is great on high frequency. |
| Detection depth | Deeper than the high frequency. Bottom echo is prominent because of wide beam width so fish echoes are hidden. | Shallower than the low frequency. Bottom echo is less prominent because of narrow beam width so fish echoes are easy to find. |
| Detection range(detection "leaks") | Detection area is wide (beam width is wide). | Detection area is narrow (beam width is narrow). |
| Detection of bottom fish | Fish echo and bottom echo overlap.(Wide beam width) | Fish echo and bottom echo are displayed separately.(Narrow beam width) |
| Detection of bait fish | Not suited for this purpose.(Bait fish are not easily detected with low frequency.) | Well suited for this purpose.(Bait fish are more easily detected with high frequency.) |
| Affected by air bubbles from other vessels | Low frequency is easily interfered by cavitation from other vessels. | High frequency is not easily interfered by cavitation from other vessels. |

The dual-frequency display is useful for comparing the picture from one frequency against the other to overcome deficiencies in both. Use the single-frequency for objective-specific fishing.

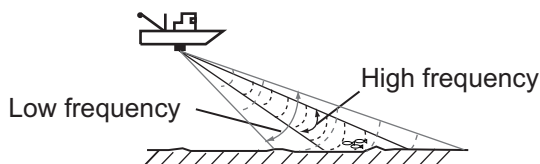

Frequency selection and mode

Single-frequency display or combination display (other than vertical scan combination): The **LF/HF** key chooses low frequency or high frequency alternately.

Dual-frequency display (mix mode OFF): The **LF/HF** key switches the frequency of the high-and low-frequency displays alternately.

Dual-frequency display (mix mode ON): The **LF/HF** key changes the frequency of the left-hand display* (top display in dual-frequency vertical scan display) from low to high alternately.

* Dual-frequency horizontal display, Dual-frequency horizontal expansion display, Dual-frequency echo sounder display.

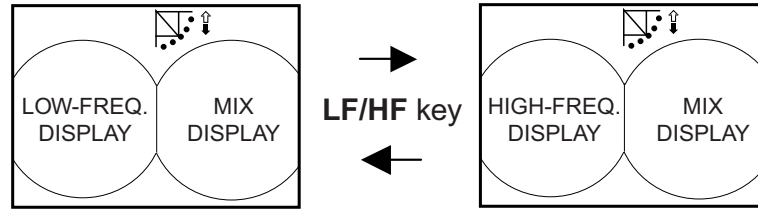

Frequency switching in dual-frequency combination display, mix display ON

Combination display (vertical scan combination): Main window is active: The **LF/HF** key changes the frequency of the main window from low to high alternately. Sub window is active: The **LF/HF** key changes the frequency of the sub window from low to high alternately.

To switch between main and sub windows use the **MAIN/SUB** key.

2.9.2 Choosing the combination display

On the CH-600, the combination display can be selected from the following five types.

1. HOR./HISTORY 2. HOR./VERT 3. HOR./VERT ZOOM 4. Full A-Scope 5. HOR./Full A-Scope

The key control differs because switching the dual-frequency is available on the CH-600.

Choosing the combination display

1. Press  key on the "DISPLAY MODE" key selection of the control unit.

Combination selection window appears for four seconds.

Note: The selection window shows the combination display set as "ON" in the "System Setting 3" menu.

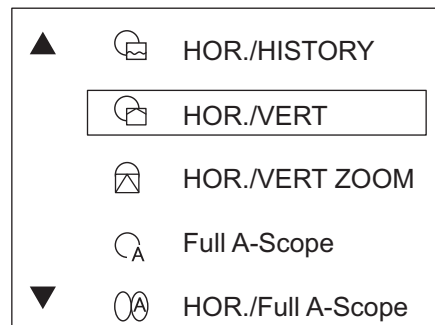

2. Press ▼ or ▲ to select the required display.

Or you can select the required display by pressing  key repeatedly.

3. Press **MENU** key to close the combination selection window.
The window will automatically close when no key was operated for four seconds.

2. HORIZONTAL MODE

Note 1: When only one of the combination display is set as “On”, combination selection window does not appear. The selected combination will directly appear.

Note 2: When all of the selection are set as “Off” in the “System Setting 3” menu, “HOR./VERT” will directly appear.

2.10 How to Interpret the Horizontal Display

The wide sounding beam is emitted from the soundome at a certain tilt angle (see hatched area in the figure below).

At the default setting, the information (target echoes) obtained by this beam is displayed in sectors at 6° increments on the screen. Thus, all directions around the boat are sounded in 60 transmissions.

The train speed can be adjusted to suit your needs (see section 2.11).

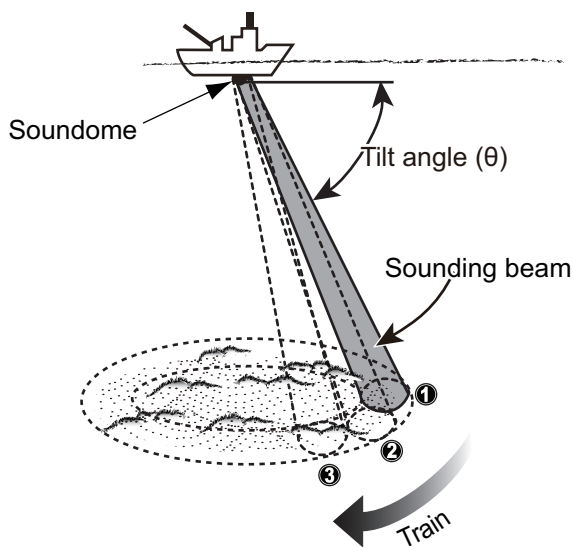

Normal train speed takes a “picture” at 6° intervals.

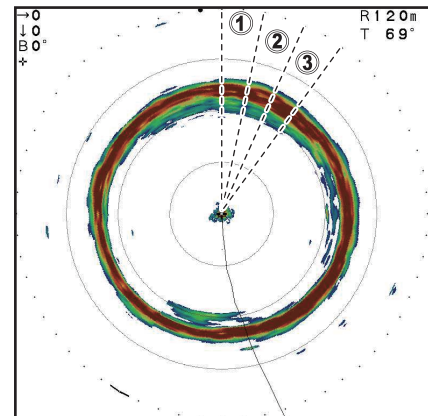

Each “dot” on the outer ring of the horizontal display indicates 6° . In this example, the scans are done at 12° intervals.

How the Horizontal mode picture is displayed on the screen

The appearance of echoes on the screen varies, depending on factors such as transmission frequency, gain and TVG settings, seabed composition and contours.

Bottom echoes

When the tilt angle is changed, the seabed echo appears on-screen in the manner shown below. When the tilt is decreased, the bottom trace become weaker. By observing the seabed condition on the display, you can prevent damage to your nets.

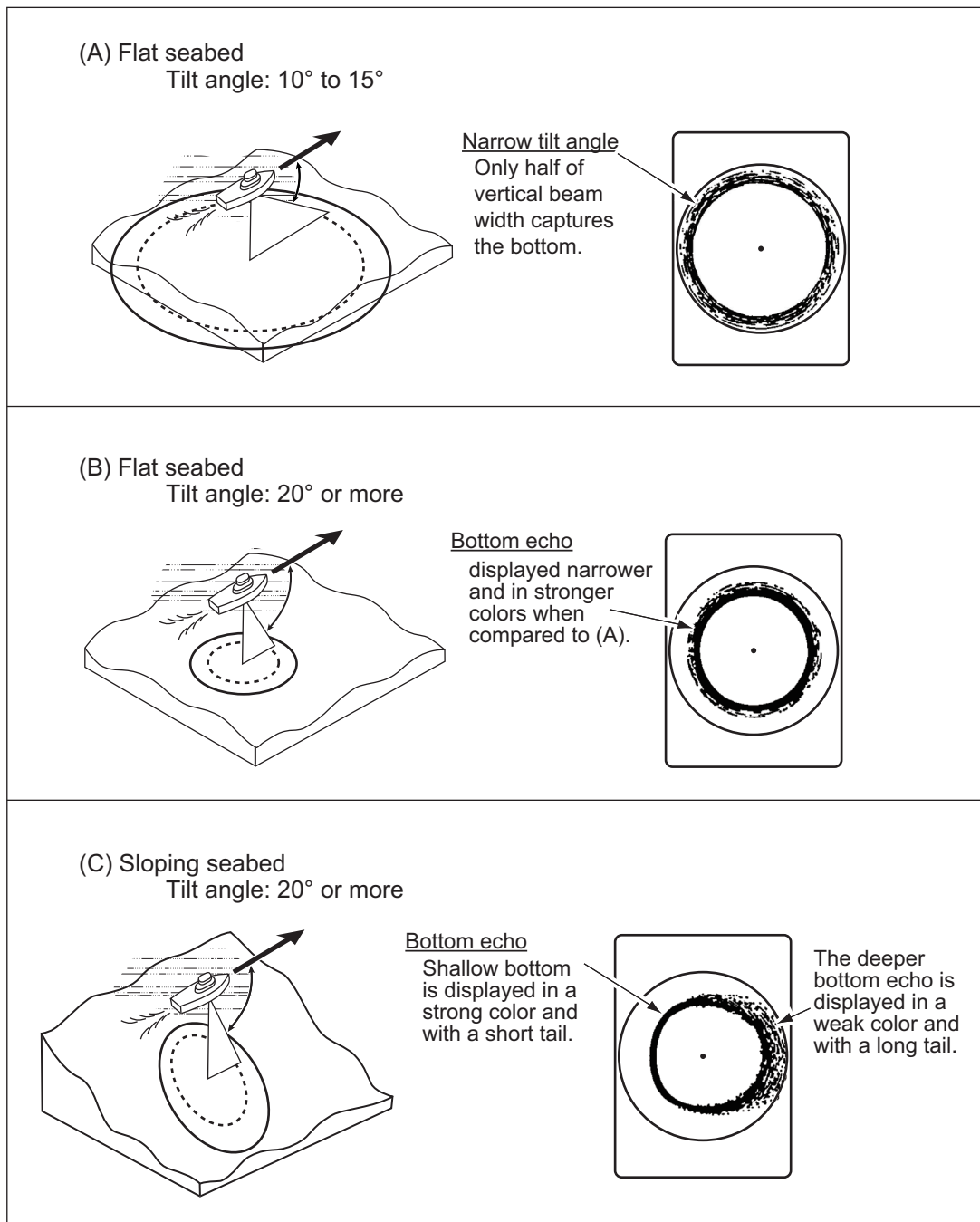

2. HORIZONTAL MODE

Fish schools

Fish schools appear as a mass of echoes on the screen. The color of the mass indicates the school density. To find the distribution and center of a school, try using different tilt angles.

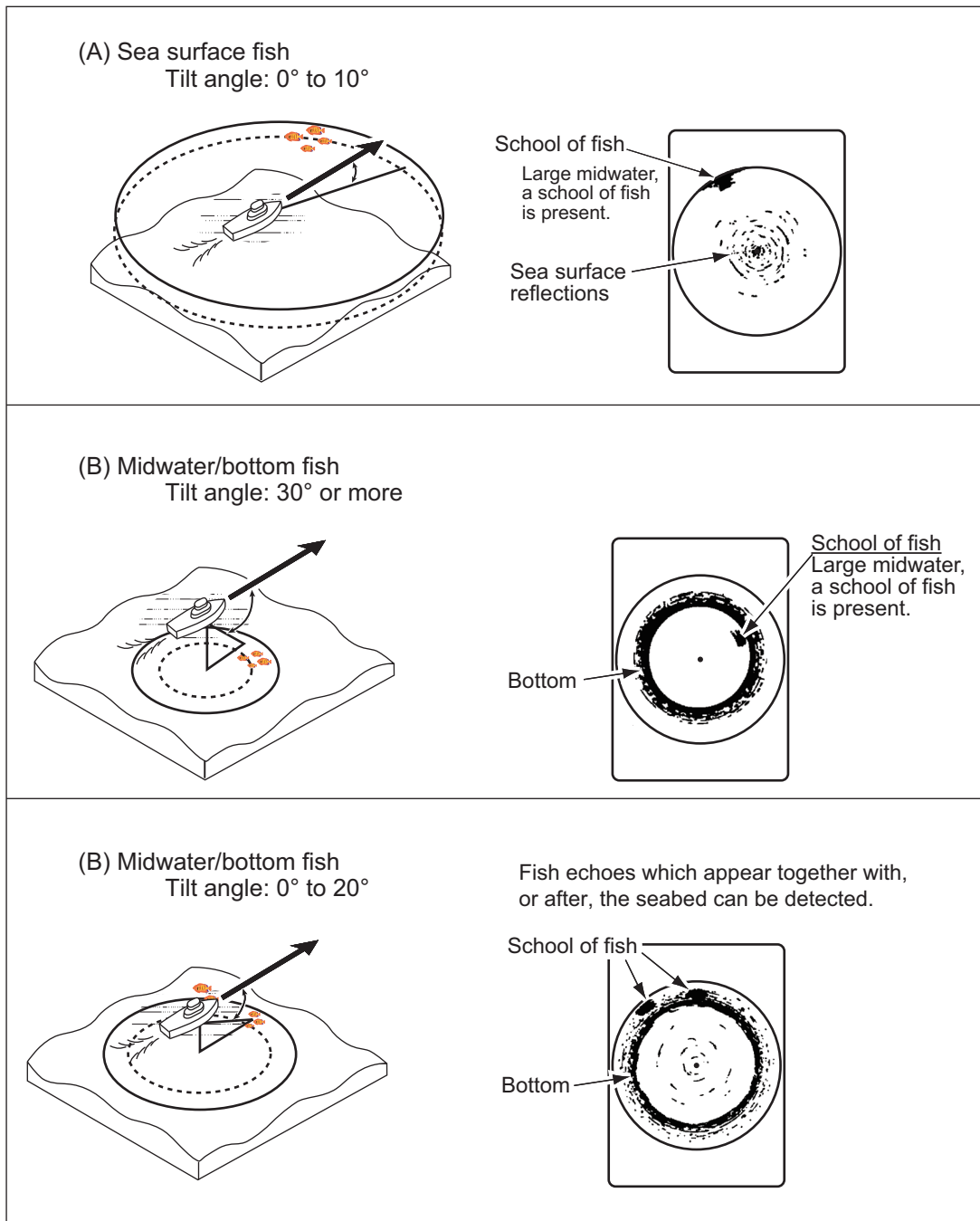

When the tilt angle is shallow, the reflection echo from the seabed is weaker. This makes the fish echoes from the seabed easier to find.

2.11 How to Select the Training Speed

The training speed is the increments at which sounding beam is transmitted in one full circle (360°). Depending on your needs, you may want to change the speed.

A high speed (lower increments) displays the echoes in a “rough” manner, but is better for tracking fast moving objects, such as a particular school of fish. A low speed (higher increments) display smoother echoes, but fast moving objects may not be detected.

The default training speed is 6°.

To change the training speed at any time, press the **Train Speed** button ().

With each press of the button, the train speed cycles through speeds in the following order: 6°, 12°, 15°, 18°, 21°, 24°, 6°...

You can disable one or more of the train speed presets, depending on your needs. See section 5.8.

2.12 How to Use the Vertical Search Feature

When a school of fish is detected by the horizontal scan, it may be difficult to estimate the distance of the school from the seabed, or the distribution of fish within the school. Unlike the fan-shaped beam used in Vertical mode, the [VERT. Search] feature “focuses” on the selected area and instantly changes the display mode to allow you a clearer view of the school location in relation to the seabed and your ship.

This feature requires a function key set as the [VERT. Search] short-cut key. In the following procedure, the default setting (key 1) is used. To set up short-cut keys, see section 5.6.2.

1. Set the system to one of the Horizontal modes outlined in this chapter.
2. When a fish or school echo is detected, press the **1** function key. The display automatically switches to the Vertical mode to search for the echo.
3. Adjust tilt and train to find the fish or school echo again.
4. When the echo appears on the screen again, place the cursor on the echo and read the depth/range indications at the top of the screen.
5. To return to the display mode used before activating the Vertical Search, press the **1** key again.

2.13 How to Adjust the Picture

2.13.1 How to suppress seabed/surface reflections with TX power

In shallow fishing grounds, excessive sea surface and bottom reflections often interfere with wanted fish echoes and they cannot be eliminated sufficiently with the TVG controls. In such cases, try to reduce the output power, without turning down the gain. The picture becomes clearer when output power is reduced rather than when the gain is decreased.

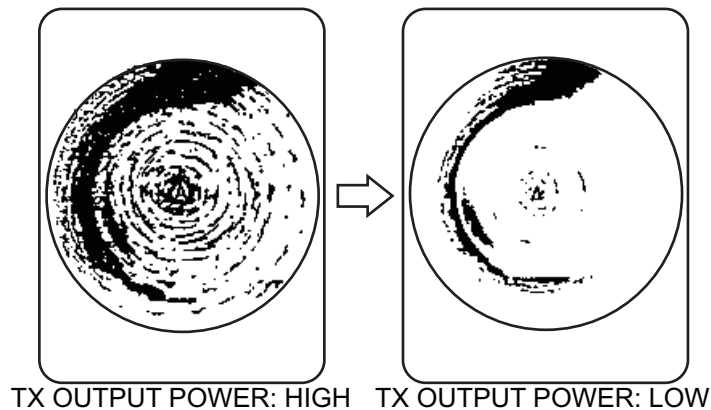

1. Press the **MENU** key to open the menu.
2. Press **▲** to select the menu bar.
3. Press **▶** or **◀** to select [COM1].
4. Press **▼** to select [TX Power], then press **▶** to show the [TX Power] settings.
5. Press **▶** to select [Low].
For long-range detection, this setting should be set to [High].
6. Press the **MENU** key to close the menu and apply the changes.

2.13.2 How to suppress bottom tail with pulselength

Fish schools near the bottom are sometimes difficult to detect because you have to discriminate fish echoes from the seabed reflections. To help discriminate fish echoes near the seabed, use a short pulselength to decrease the tail from seabed reflections.

1. Press the **MENU** key to open the menu.
2. Press **▲** to select the menu bar.
3. Press **▶** or **◀** to select [COM1].
4. Press **▼** to select [TX Pulselength], then press **▶** to show the [TX Pulselength] settings.
5. Press **▶** to select [Short].
6. Press the **MENU** key to close the menu and apply the changes.

2.13.3 How to display weak echoes clearly with TVG

Echoes from targets (such as the bottom or a fish) return to the transducer in order of the distance to them, and when their intensities are compared at the transducer face, those from nearer targets are generally stronger when their reflecting properties are nearly equal.

If these echoes are displayed directly on the screen, the size of the displayed echo from the same school of fish may change with distance, making it difficult to judge the actual size of the school of fish.

To overcome this inconvenience, use the TVG function. It compensates for propagation loss of sound in water: amplification of echoes on short range is suppressed and gradually increased as range increases, so that similar targets are displayed in similar intensities irrespective of the ranges to them.

The TVG also functions to suppress unwanted echoes and noise which appears in a certain range area on the screen.

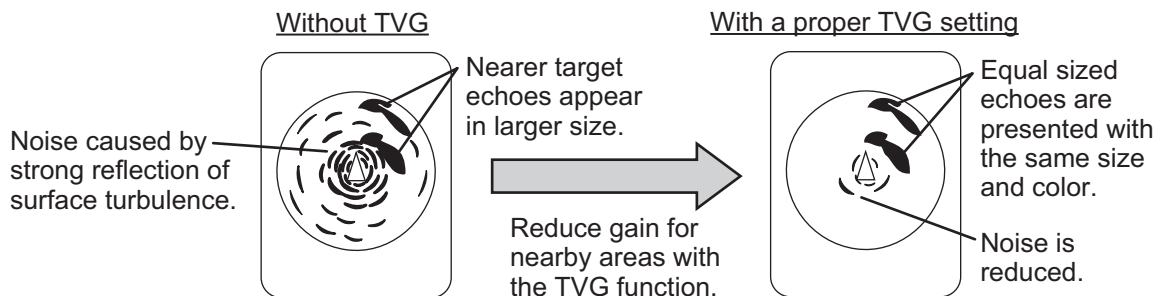

Note: Use this function with caution, excessive TVG may eliminate short-range echoes.

How to adjust the TVG

1. Press the **MENU** key to open the menu.
2. Press **▲** to select the menu bar.
3. Press **▶** or **◀** to select [HOR.].
4. To reduce reflections from the sea surface or plankton, press **▼** to select [TVG Level] ([TVG Level-LF]/[TVG Level-HF] on CH-600), then press **▶** to show the [TVG Level] settings.

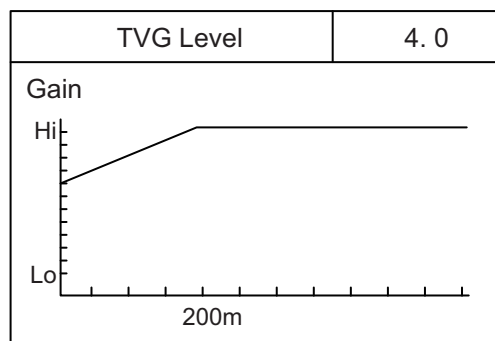

2. HORIZONTAL MODE

- Press **▶** or **◀** to adjust the TVG level. Ideally, a setting between 2.0 and 5.0 should be sufficient. A larger setting reduces the gain over distance. As the setting is adjusted, the current setting is shown in a dashed line and the level indication changes to show the new setting.

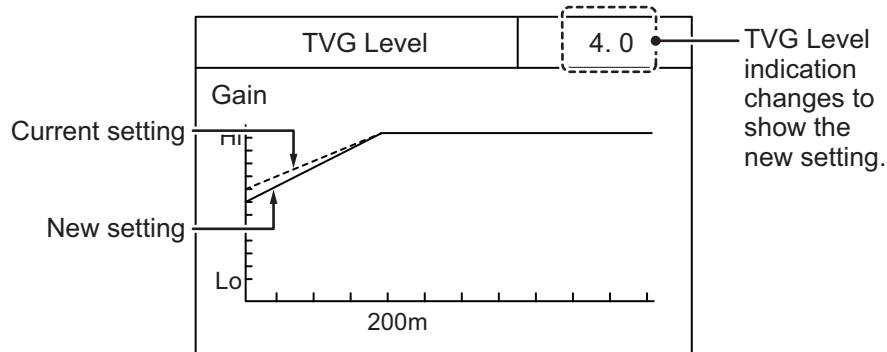

- Press **▼** to select [TVG Distance] ([TVG Distance-LF]/[TVG Distance-HF]) on CH-600, then press **▶** to show the [TVG Distance] settings.

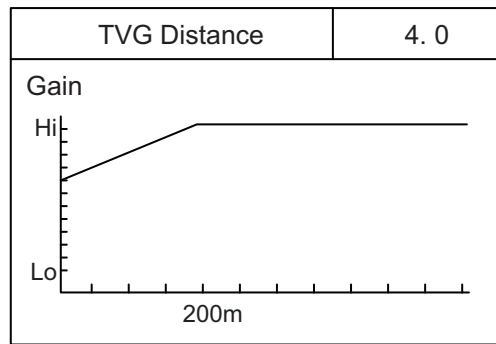

- Press **▶** or **◀** to adjust the TVG level. Ideally a setting between 3.0 and 5.0 (130 m to 320 m) is sufficient. As the setting is adjusted, the current setting is shown in a dashed line and the level indication changes to show the new setting.

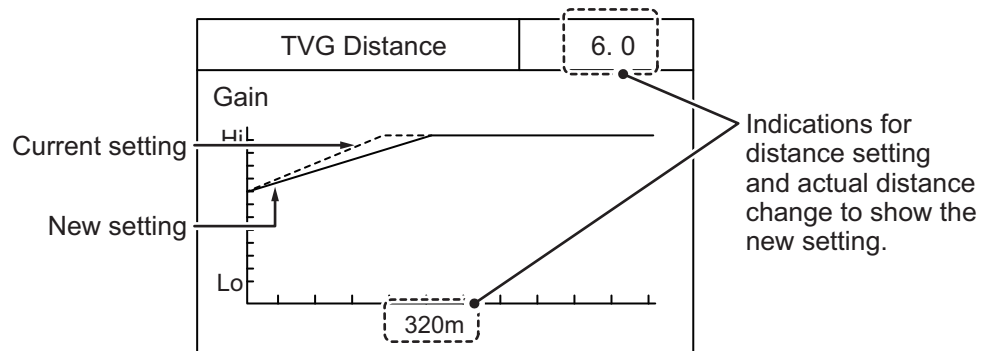

The preset distance, in order of [TVG Distance] setting, is as shown in the table below.

| Unit of measurement | TVG Distance setting | | | | | | | | | | |
|---------------------|----------------------|-----|-----|-----|-----|-----|-----|-----|-----|-----|------|
| | 0 | 0.5 | 1.0 | 1.5 | 2.0 | 2.5 | 3.0 | 3.5 | 4.0 | 4.5 | 5.0 |
| Meters (m) | 3 | 8 | 20 | 40 | 60 | 100 | 130 | 160 | 200 | 250 | 320 |
| Feet (ft) | 10 | 30 | 70 | 130 | 210 | 330 | 410 | 520 | 660 | 820 | 1040 |
| Fathoms (fm) | 2 | 5 | 10 | 20 | 40 | 60 | 80 | 100 | 110 | 140 | 170 |
| Hiro (HR) | 2 | 5 | 10 | 20 | 40 | 60 | 80 | 100 | 130 | 170 | 210 |
| Passi/braza (pb) | 2 | 5 | 10 | 20 | 40 | 60 | 80 | 100 | 120 | 150 | 180 |

| Unit of measurement | TVG Distance setting | | | | | | | | | |
|---------------------|----------------------|------|------|------|------|------|------|------|------|------|
| | 5.5 | 6.0 | 6.5 | 7.0 | 7.5 | 8.0 | 8.5 | 9.0 | 9.5 | 10.0 |
| Meters (m) | 360 | 400 | 450 | 500 | 560 | 630 | 710 | 790 | 890 | 1000 |
| Feet (ft) | 1160 | 1300 | 1470 | 1640 | 1840 | 2070 | 2320 | 2600 | 2920 | 3280 |
| Fathoms (fm) | 200 | 220 | 250 | 280 | 300 | 340 | 390 | 430 | 490 | 550 |
| Hiro (HR) | 230 | 260 | 300 | 330 | 370 | 420 | 470 | 520 | 590 | 660 |
| Passi/braza (pb) | 210 | 240 | 270 | 300 | 340 | 380 | 430 | 480 | 540 | 600 |

8. Press the **MENU** key to close the menu and apply the changes.

2. HORIZONTAL MODE

This page is intentionally left blank.

3. VERTICAL SCAN MODE

3.1 Vertical Mode

The Vertical display mode shows a “cross-section” of the water below and around the ship by using a “fan-shaped” beam. This mode is useful when you want to view a sector below and around your ship.

To view this display mode, press .

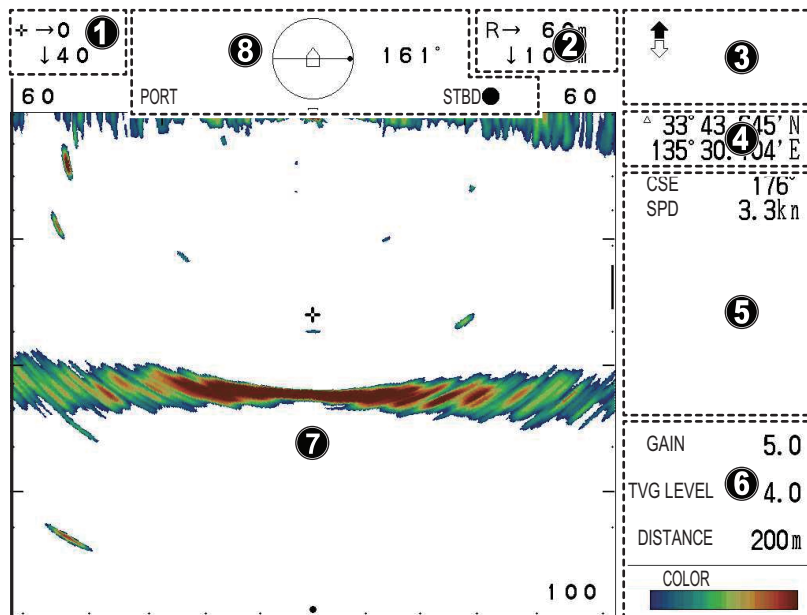

| Number | Description |
|--------|--|
| 1 | Indications for cursor position. (Horizontal distance, depth and bearing.) |
| 2 | Indications for range and tilt. |
| 3 | Indications for transducer raise/lower status. |
| 4 | Own ship or cursor position (latitude/longitude). Note: Requires connection to appropriate sensors. |
| 5 | Navigational data.(Heading, speed, depth, water temperature, tidal current information.) Note: Requires connection to appropriate sensors. |
| 6 | Echo display settings. (Gain, TVG level, distance.) |
| 7 | Vertical scan echo display area. |
| 8 | Indications for scan direction and train bearing. |

3.2 Vertical Menu Overview

The [VERT] (Vertical) menu contains the settings and adjustments for Vertical scan mode.

To access the VERT menu, do the following:

1. Press the **MENU** key to open the menu.
2. Press **▲** to select the menu bar.
3. Press **▶** or **◀** to select [VERT].

The Vertical menu appears.

| Menu | COM1 | COM2 | HOR. | VERT | ES | FUNC Key | System |
|--------------|------|------|------|-------------|----|----------|--------|
| TVG Level | | 4.0 | | | | | |
| TVG Distance | | 4.0 | | | | | |
| Gain ADJ. | | 0 | | | | | |
| RES. Color | | LOG | | | | | |
| Clutter | | 0 | | | | | |
| HOR. Range | | X 1 | | | | | |

▲▼: Select ◀▶: Change Menu: Apply

Note: The CH-600 can set [TVG Level], [TVG Distance], [Gain ADJ.], [RES. Color] and [Clutter] for LF or HF respectively.

The table below lists the menu items with a brief explanation, along with the settings and ranges available.

| Menu item | Description | Settings/Ranges |
|----------------|---|---|
| [TVG Level] | Time Varied Gain. Compensates for propagation loss of sound in water. See section 2.13.3. | 0.0 to 10.0; default: 4.0 |
| [TVG Distance] | Time Varied Gain. Compensates for propagation loss of sound in water. See section 2.13.3. | 0.0 to 10.0; default: 4.0 |
| [Gain ADJ.] | Adjust the level of gain. | -10 to +10; default: 0 |
| [RES. Color] | Sets the color scheme for echo display, based on echo strength. <ul style="list-style-type: none"> • LOG: Weak to strong echoes are displayed in colors respective to their echo strength. • Linear: Downplays weak echoes, compared to LOG. Effective for suppressing weak echoes such as plankton. • Square: Strong echoes are emphasized more than in Linear. • Cube: Strong echoes are emphasized even more than in Square. | LOG, Linear, Square, Cube; default: LOG |
| [Clutter] | Suppresses low intensity echoes, such as sediment. The higher the number (setting) the weaker the echoes which are erased. | 0, 1, 2, 3; default: 0 |
| [HOR. Range] | Sets the horizontal range expansion factor for horizontal scan mode. Note: This feature is not adjustable when the target lock function or vertical search function is active. | ×1, ×2; default: ×1 |

3.3 How to Interpret the Vertical Scan Display

The sound beam is emitted in a vertical half-circle, which forms a sounding area similar to a slice of watermelon. This gives the user a better view of the underwater conditions. The bearing of the vertical sounding beam can be selected manually or automatically.

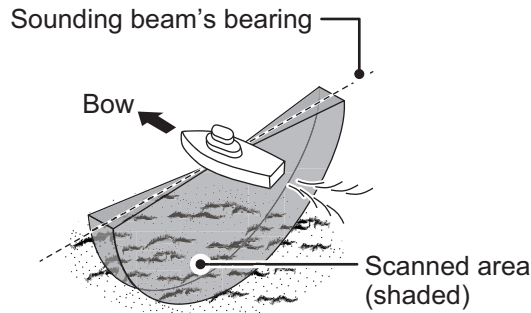

Port-starboard scan (seabed)

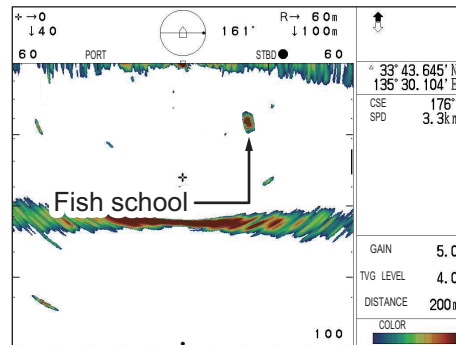
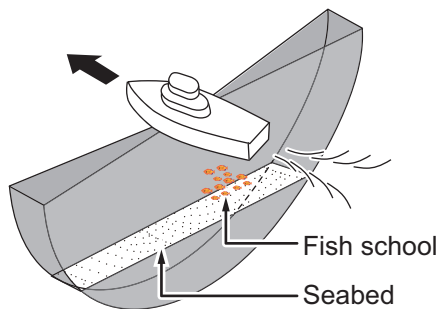

In this example, you can see the echoes of a fish school to the right (starboard) of the ship. Note that the seabed echo is displayed wider as the distance from the ship increases. This can make it difficult to see fish near the seabed.

Fore-aft scan, passing over a school of fish

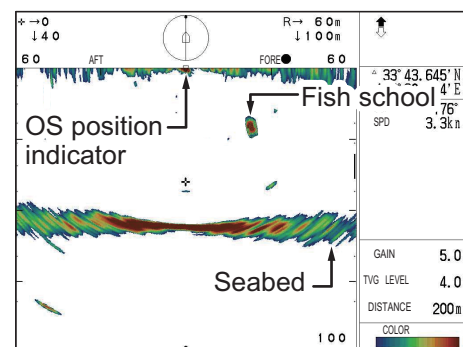
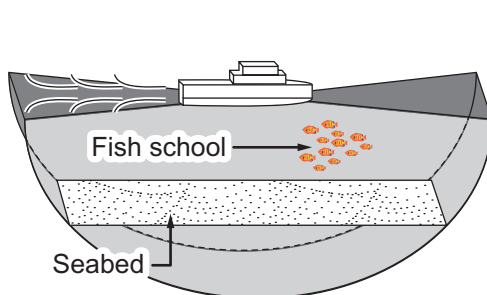

In this example, you can see the echoes of a fish school in front of the ship (fore). Note that the seabed echo is displayed wider as the distance from the ship increases.

3.4 How to Toggle Full/Half Range Scans

You can alternate the scanned area between full-range scan and half-range scan with the **FULL/HALF SECTOR** key .

For detailed instructions on sectors and how to use the **FULL/HALF SECTOR** key, see section 1.13.2.

3.5 How to Select the Training Speed

The training speed chooses how fast the transducer scans the display sector. Two choices are available, 3° (normal speed, default setting) and 6° (high speed).

To change the training speed at any time, press the **Train Speed** button (.

With each press of the button, the train speed switches between 3° and 6°, and the scan speed is indicated at the top-center of the echo display area.

3.6 How to Adjust the Picture

Echoes from targets (such as the bottom or a fish) return to the transducer in order of the distance to them, and when their intensities are compared at the transducer face, those from nearer targets are generally stronger when their reflecting properties are nearly equal.

If these echoes are displayed directly on the screen, the size of the displayed echo from the same school of fish may change with distance, making it difficult to judge the actual size of the school of fish.

To overcome this inconvenience, use the TVG function. It compensates for propagation loss of sound in water: amplification of echoes on short range is suppressed and gradually increased as range increases, so that similar targets are displayed in similar intensities irrespective of the ranges to them.

The TVG also functions to suppress unwanted echoes and noise which appears in a certain range area on the screen.

How to adjust the TVG for vertical scan mode

1. Press the **MENU** key to open the menu.
2. Press **▲** to select the menu bar.
3. Press **▶** or **◀** to select [VERT].

4. To reduce reflections from the sea surface or plankton, press ▼ to select [TVG Level] ([TVG Level-LF]/[TVG Level-HF] on CH-600), then press ► to show the [TVG Level] settings.

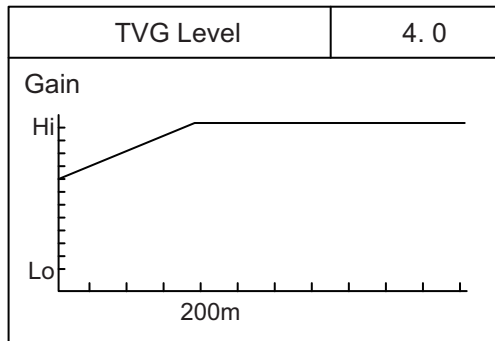

5. Press ► or ◀ to adjust the TVG level. Ideally, a setting between 2.0 and 5.0 should be sufficient. A larger setting reduces the gain over distance. As the setting is adjusted, the current setting is shown in a dashed line and the level indication changes to show the new setting.

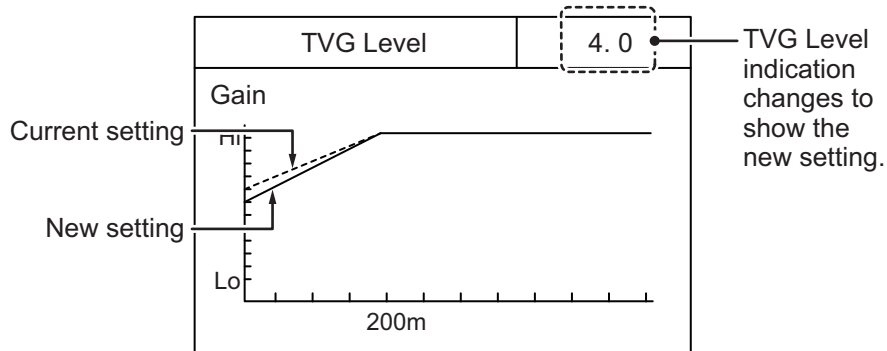

6. Press ▼ to select [TVG Distance] ([TVG Distance-LF]/[TVG Distance-HF] on CH-600), then press ► to show the [TVG Distance] settings.

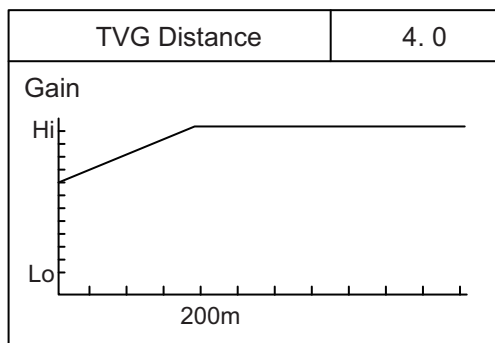

7. Press ► or ◀ to adjust the TVG level. Ideally a setting between 3.0 and 5.0 (130 m to 320 m) is sufficient.

3. VERTICAL SCAN MODE

As the setting is adjusted, the current setting is shown in a dashed line and the level indication changes to show the new setting.

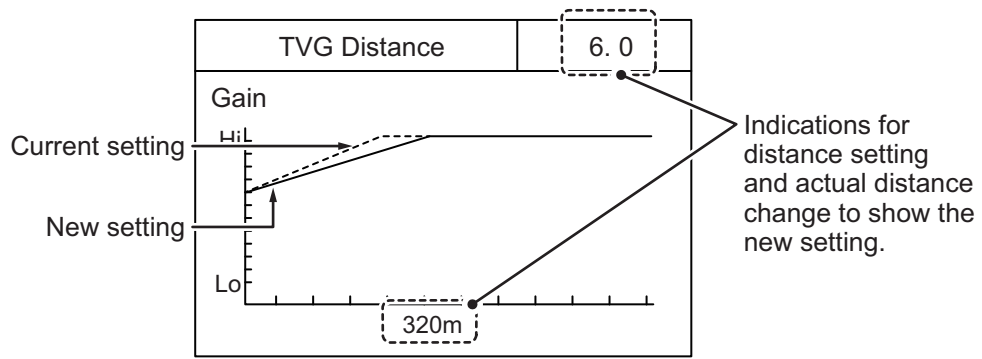

The preset distance, in order of [TVG Distance] setting, is as shown in the table on the following page.

- Press the **MENU** key to close the menu and apply the changes.

| Unit of measurement | TVG Distance setting | | | | | | | | | | |
|---------------------|----------------------|-----|-----|-----|-----|-----|-----|-----|-----|-----|------|
| | 0 | 0.5 | 1.0 | 1.5 | 2.0 | 2.5 | 3.0 | 3.5 | 4.0 | 4.5 | 5.0 |
| Meters (m) | 3 | 8 | 20 | 40 | 60 | 100 | 130 | 160 | 200 | 250 | 320 |
| Feet (ft) | 10 | 30 | 70 | 130 | 210 | 330 | 410 | 520 | 660 | 820 | 1040 |
| Fathoms (fm) | 2 | 5 | 10 | 20 | 40 | 60 | 80 | 100 | 110 | 140 | 170 |
| Hiro (HR) | 2 | 5 | 10 | 20 | 40 | 60 | 80 | 100 | 130 | 170 | 210 |
| Passi/braza (pb) | 2 | 5 | 10 | 20 | 40 | 60 | 80 | 100 | 120 | 150 | 180 |

| Unit of measurement | TVG Distance setting | | | | | | | | | |
|---------------------|----------------------|------|------|------|------|------|------|------|------|------|
| | 5.5 | 6.0 | 6.5 | 7.0 | 7.5 | 8.0 | 8.5 | 9.0 | 9.5 | 10.0 |
| Meters (m) | 360 | 400 | 450 | 500 | 560 | 630 | 710 | 790 | 890 | 1000 |
| Feet (ft) | 1160 | 1300 | 1470 | 1640 | 1840 | 2070 | 2320 | 2600 | 2920 | 3280 |
| Fathoms (fm) | 200 | 220 | 250 | 280 | 300 | 340 | 390 | 430 | 490 | 550 |
| Hiro (HR) | 230 | 260 | 300 | 330 | 370 | 420 | 470 | 520 | 590 | 660 |
| Passi/braza (pb) | 210 | 240 | 270 | 300 | 340 | 380 | 430 | 480 | 540 | 600 |

4. ECHO SOUNDER MODE

4.1 Typical Echo Sounder Display

The Echo Sounder display mode shows echoes in a manner similar to a conventional fish finder.

To view this display mode, press .

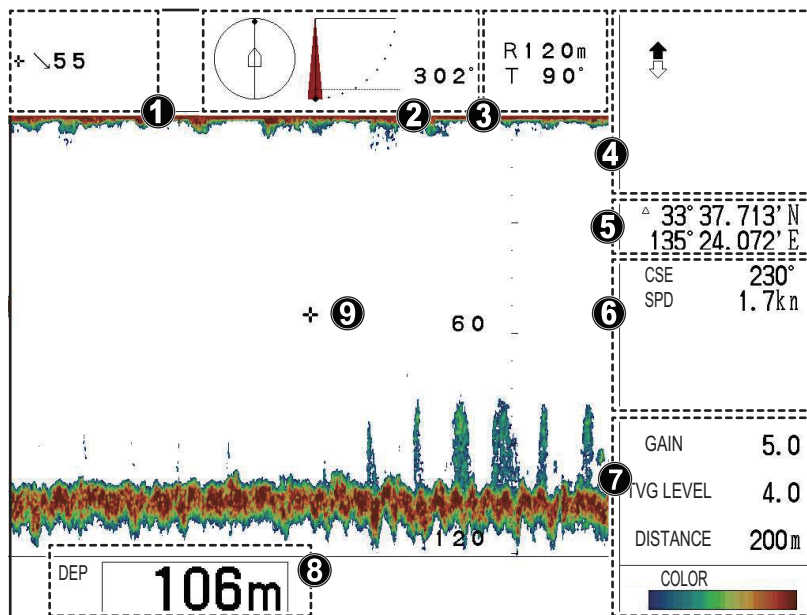

| Number | Description |
|--------|--|
| 1 | Indications for cursor position. (Range from own ship.) |
| 2 | Indications for scan direction, tilt angle and train bearing. |
| 3 | Indications for range and tilt. |
| 4 | Indications for transducer raise/lower status. |
| 5 | Own ship or cursor position (latitude/longitude). Note: Requires connection to appropriate sensors. |
| 6 | Navigational data.(Heading, speed, depth, water temperature, tidal current information.) Note: Requires connection to appropriate sensors. |
| 7 | Echo display settings. (Gain, TVG level, distance.) |
| 8 | Depth indication |
| 9 | Fish finder echo display. |

4.2 Echo Sounder Menu Overview

The [ES] (Echo Sounder, Fish Finder) menu contains settings and adjustments for the Echo Sounder mode.

To access the [ES] menu, do the following:

1. Press the **MENU** key to open the menu.
2. Press **▲** to select the menu bar.
3. Press **▶** or **◀** to select [ES].

The Echo Sounder menu appears.

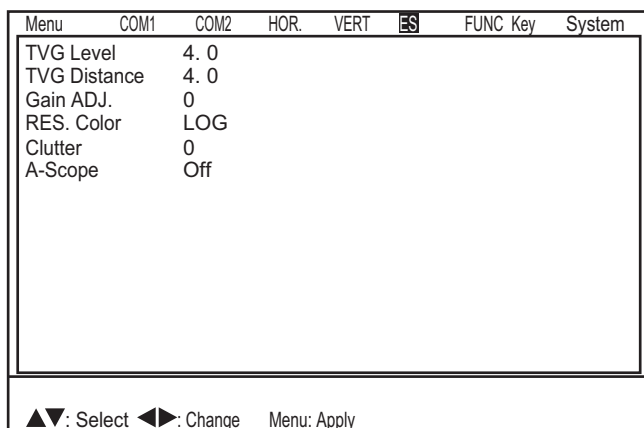

Note: The CH-600 can set [TVG Level], [TVG Distance], [Gain ADJ.], [RES. Color] and [Clutter] for LF or HF respectively.

The table below lists the menu items with a brief explanation, along with the settings and ranges available.

| Menu item | Description | Settings/Ranges |
|----------------|---|---|
| [TVG Level] | Time Varied Gain. Compensates for propagation loss of sound in water. See section 2.13.3. | 0.0 to 10.0; default: 4.0 |
| [TVG Distance] | Time Varied Gain. Compensates for propagation loss of sound in water. See section 2.13.3. | 0.0 to 10.0; default: 4.0 |
| [Gain ADJ.] | Adjust the level of gain. | -10 to +10; default: 0 |
| [RES. Color] | Sets the color scheme for echo display, based on echo strength. <ul style="list-style-type: none"> • LOG: Weak to strong echoes are displayed in colors respective to their echo strength. • Linear: Downplays weak echoes, compared to LOG. Effective for suppressing weak echoes such as plankton. • Square: Strong echoes are emphasized more than in Linear. • Cube: Strong echoes are emphasized even more than in Square. | LOG, Linear, Square, Cube; default: LOG |
| [Clutter] | Suppresses low intensity echoes, such as sediment. The higher the number (setting) the weaker the echoes which are erased. | 0, 1, 2, 3; default: 0 |
| [A-Scope] | Enables/disables the A-Scope for Horizontal mode. | Off, On; default: Off |

4.3 How to Adjust the Range

The **RANGE** knob adjusts the range for echo detection and display on all display modes. There are 15 preset ranges, for Horizontal, Vertical and Echo Sounder modes, which can be changed to suit your needs.

For preset range default settings, see section 1.10.

4.4 How to Adjust the Tilt

You can point the transducer in any direction between the bottom of the ship (90°) and to the front of the ship (0°).

To change the title angle, rotate the **TILT** control. The tilt is adjusted in 1° increments and the selected angle appears at the top-center of the echo display area for a few seconds.

4.5 How to Select the Picture Advance Speed

Picture advance speed determines how quickly the scan is displayed on the screen, from right to left. When selecting a picture advance speed, keep in mind that a fast speed will expand the echoes horizontally, while a slow speed will contract the echoes.

1. With the Echo Sounder display mode active, press the **FAST SCAN** key  .
The [Pic. Advance] popup window appears.
2. Press the **FAST SCAN** key to cycle through the settings, or press the Cursor Pad to select the appropriate speed setting.
The **FAST SCAN** key cycles through the settings in the following order:
1/1 → 2/1 → 1/8 → 1/4 → 1/2 → 1/1...
Note: When using the CursorPad to select the speed, the cursor stops at the highest setting (2/1) and the lowest setting (1/8).
The default setting for picture advance is 1/1.

Picture advance speed and changes to echo display

- 1/1: Picture advances normally, no change to echoes.
- 2/1: Picture advance at twice the normal speed, echoes are expanded.
- 1/8: Picture advances at one-eighth normal speed, echoes are heavily contracted.
- 1/4: Picture advances at one-quarter normal speed, echoes are moderately contracted.
- 1/2: Picture advances at one-half normal speed, echoes are slightly contracted.

4.6 How to Adjust the Picture

Echoes from targets (such as the bottom or a fish) return to the transducer in order of the distance to them, and when their intensities are compared at the transducer face, those from nearer targets are generally stronger when their reflecting properties are nearly equal.

If these echoes are displayed directly on the screen, the size of the displayed echo from the same school of fish may change with distance, making it difficult to judge the actual size of the school of fish.

To overcome this inconvenience, use the TVG function. It compensates for propagation loss of sound in water: amplification of echoes on short range is suppressed and gradually increased as range increases, so that similar targets are displayed in similar intensities irrespective of the ranges to them.

The TVG also functions to suppress unwanted echoes and noise which appears in a certain range area on the screen.

4.6.1 How to adjust the TVG for echo sounder mode

1. Press the **MENU** key to open the menu.
2. Press **▲** to select the menu bar.
3. Press **▶** or **◀** to select [ES].
4. To reduce reflections from the sea surface or plankton, press **▼** to select [TVG Level] ([TVG Level-LF]/[TVG Level-HF] on CH-600), then press **▶** to show the [TVG Level] settings.

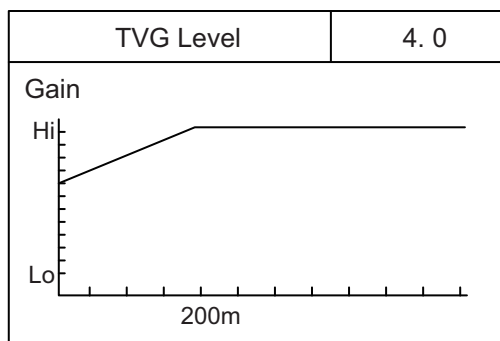

5. Press **▶** or **◀** to adjust the TVG level. Ideally, a setting between 2.0 and 5.0 should be sufficient. A larger setting reduces the gain over distance. As the setting is adjusted, the current setting is shown in a dashed line and the level indication changes to show the new setting.

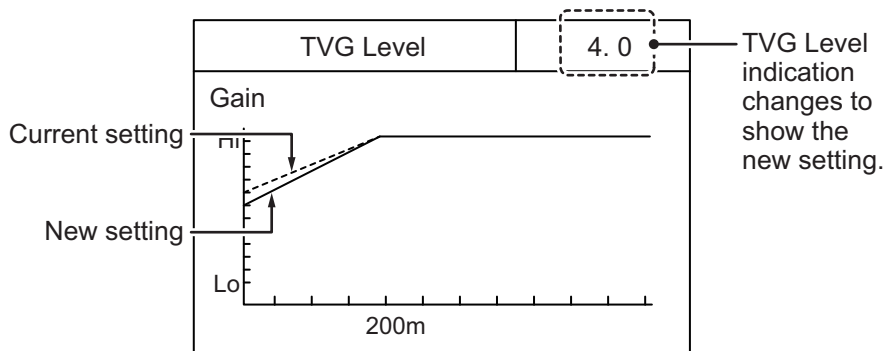

6. Press ▼ to select [TVG Distance] ([TVG Distance-LF]/[TVG Distance-HF] on CH-600), then press ► to show the [TVG Distance] settings.

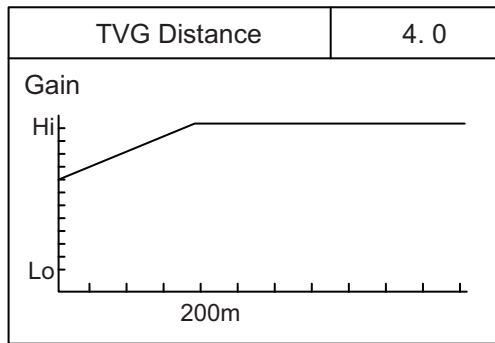

7. Press ► or ◀ to adjust the TVG level. Ideally a setting between 3.0 and 5.0 (130 m to 320 m) is sufficient. As the setting is adjusted, the current setting is shown in a dashed line and the level indication changes to show the new setting.

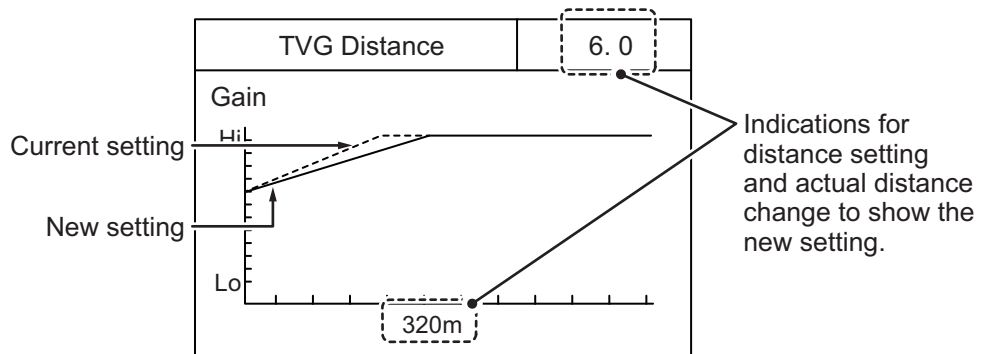

The preset distance, in order of [TVG Distance] setting, is as shown in the table on the following page.

8. Press the **MENU** key to close the menu and apply the changes.

| Unit of measurement | TVG Distance setting | | | | | | | | | | |
|---------------------|----------------------|-----|-----|-----|-----|-----|-----|-----|-----|-----|------|
| | 0 | 0.5 | 1.0 | 1.5 | 2.0 | 2.5 | 3.0 | 3.5 | 4.0 | 4.5 | 5.0 |
| Meters (m) | 3 | 8 | 20 | 40 | 60 | 100 | 130 | 160 | 200 | 250 | 320 |
| Feet (ft) | 10 | 30 | 70 | 130 | 210 | 330 | 410 | 520 | 660 | 820 | 1040 |
| Fathoms (fm) | 2 | 5 | 10 | 20 | 40 | 60 | 80 | 100 | 110 | 140 | 170 |
| Hiro (HR) | 2 | 5 | 10 | 20 | 40 | 60 | 80 | 100 | 130 | 170 | 210 |
| Passi/braza (pb) | 2 | 5 | 10 | 20 | 40 | 60 | 80 | 100 | 120 | 150 | 180 |

| Unit of measurement | TVG Distance setting | | | | | | | | | |
|---------------------|----------------------|------|------|------|------|------|------|------|------|------|
| | 5.5 | 6.0 | 6.5 | 7.0 | 7.5 | 8.0 | 8.5 | 9.0 | 9.5 | 10.0 |
| Meters (m) | 360 | 400 | 450 | 500 | 560 | 630 | 710 | 790 | 890 | 1000 |
| Feet (ft) | 1160 | 1300 | 1470 | 1640 | 1840 | 2070 | 2320 | 2600 | 2920 | 3280 |
| Fathoms (fm) | 200 | 220 | 250 | 280 | 300 | 340 | 390 | 430 | 490 | 550 |
| Hiro (HR) | 230 | 260 | 300 | 330 | 370 | 420 | 470 | 520 | 590 | 660 |
| Passi/braza (pb) | 210 | 240 | 270 | 300 | 340 | 380 | 430 | 480 | 540 | 600 |

4.6.2 How to find echo strength with the A-Scope

The A-Scope display shows echoes at each transmission, with amplitudes and tones proportional to their intensities, at the right-side of the echo display area. This is particularly useful for estimating the type of fish school, or seabed composition.

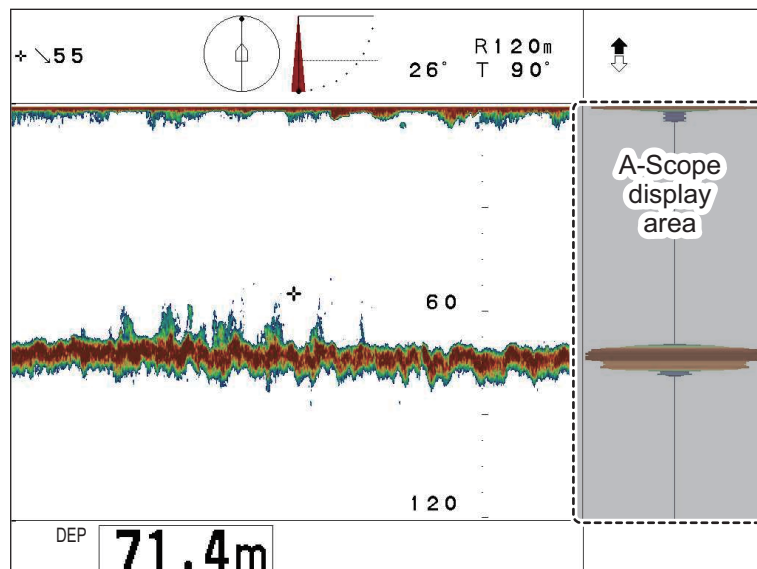

How to enable/disable the A-Scope display

To activate the A-Scope display in Horizontal mode, do the following:

1. Referring to section 4.2, access the [ES] menu.
2. Press ▼ to select [A-Scope], then press ► to show the [A-Scope] settings.
3. Press ► or ◀ to select the appropriate setting.
Select [On] to show the A-Scope, or select [Off] to hide the A-Scope.
4. Press the **MENU** key to close the menu.

5. MENU OPERATIONS

This chapter menu operations not previously explained in this manual.

5.1 How to Access and Use the Menu

There are six menus which contain items that do not require frequent adjustment after they are set.

To open the [Menu], press the **MENU** key. If the system is not turned off since the last menu operation, the last used menu is shown and the last selected menu item is highlighted (selected). If the system is turned off, the [COM1] menu is shown.

Press the **MENU** key again to close the menu.

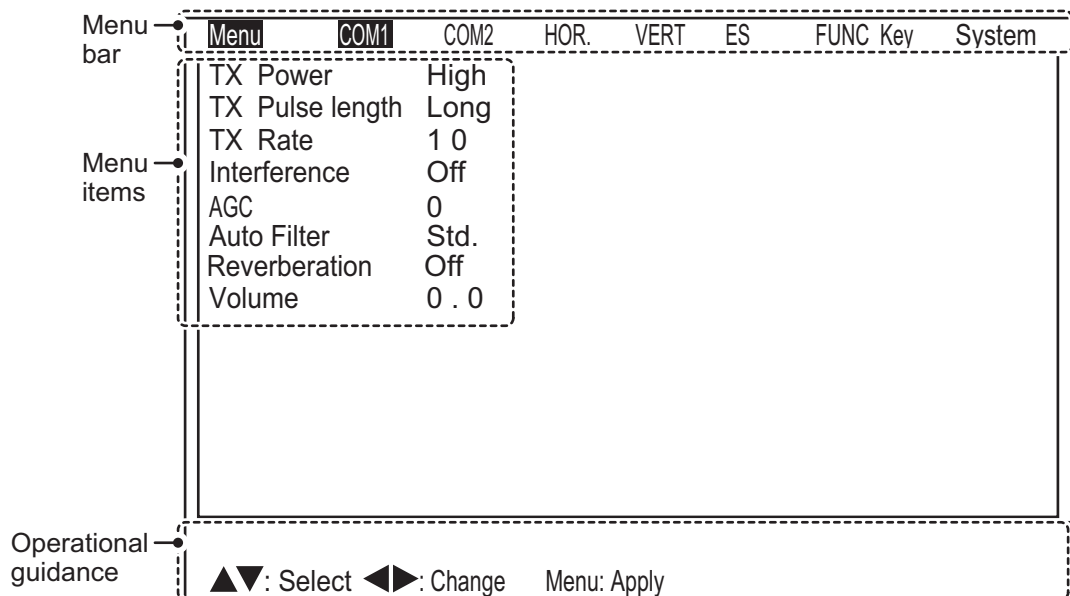

Note: The CH-600 can set [Interference], [AGC] and [Auto Filter] for LF and HF respectively.

How to use the menu

1. Press the **MENU** key. The menu window appears.
2. Press ▲ to select the menu bar.
3. Press ◀ or ▶ to select a menu.
4. Press ▼ or ▲ to move the cursor inside the menu and select a menu item.
The guidance box at the bottom of the screen shows a brief explanation for the selected item and the operations allowed for the selected menu item.
5. Press ◀ or ▶ to show the settings for the select menu item.
6. Press ◀ or ▶ to adjust or change the settings for the selected menu item.
7. To save and apply changes, press the **MENU** key.

Note: If you change a setting, then select a different menu item, the changes made to the first menu item are saved.

5.2 How to Change the Displayed Language

You can change the displayed language to suit your preferences.

1. Press the **MENU** key to open the menu.
2. Press **▲** to select the menu bar.
3. Press **▶** to select [System], then press **▼** to select [Go to SYS Menu].
4. Press **◀** to select [Yes]. The [System Menu] appears.
5. Press **▲** or **▼** to select [Language Settings].
6. Press **▶**. The [Language] menu appears.

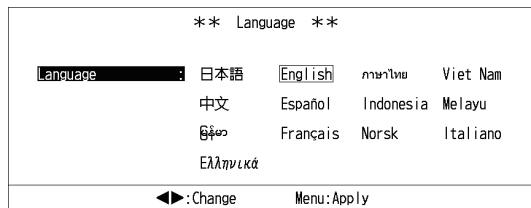

7. Press **▶** or **◀** to select the appropriate language setting, then press the **MENU** key. All menus and most indications are now displayed in the selected language.

Note: Some languages may require a password. For further information, consult your local dealer.

5.3 COM1 Menu

Referring to section 5.1, access the [COM1] menu. The following table lists the [COM1] menu contents with a brief explanation for each menu item.

| Menu item | Description | Settings/Ranges |
|------------------|--|--|
| [TX Power] | Adjusts the transmission power. | [High], [Low]; default: [High] |
| [TX Pulselength] | Sets the transmission pulselength. | [Long], [Short]; default: [Long] |
| [TX Rate] | Sets the transmission rate (number of transmissions per scan). | [EXT], [1] to [10]; default: [10] For external video sounder or sonar, select [EXT]. |
| [Interference] | Enable/disable the interference rejector. | [Off], [On]; default: [Off] |
| [AGC] | Automatic Gain Compensation. Automatically adjusts the sensitivity against strong echoes, such as those from the seabed, to emphasize weak echoes, such as those from fish close to the seabed. | [0] (Off), [1], [2], [3], [4], [5]; default: [0] |
| [Auto Filter] | Available only when [Auto Filter] in the [Audio] menu is set to [On]. Adjusts for doppler shift, created when the ship is in motion, to stabilize the displayed echoes. This feature requires speed, course and heading data. | [Wide], [Std.], [Narrow]; default: [Std.] [Wide] gives a better resolution image, however noise is increased. [Narrow] gives a lower resolution image with noise reduced. Note: Fast moving fish, such as Tuna, may not be detected when using the [Narrow] setting. |
| [Reverbration] | Reduce the volume for reverberation from the transducer. | [Off], [On]; default: [Off] |

| Menu item | Description | Settings/Ranges |
|-----------|--|---------------------------------|
| [Volume] | Adjusts the volume for the optional external speaker. The speaker emits a tone when fish are detected. | [0.0] to [10.0]; default: [0.0] |

5.4 COM2 Menu

Referring to section 5.1, access the [COM2] menu. The following table lists the [COM2] menu contents with a brief explanation for each menu item.

| Menu item | Description | Settings/Ranges |
|------------------|---|---|
| [Delete Tack] | Deletes the own ship track. | [No], [Yes]; default: [No] |
| [White Marker] | Disable/enable the white marker. The white marker can be set to a corresponding echo strength (color), which is then displayed in white. this function is useful when you need to separate bottom fish from the seabed. | Setting range depends on setting for [Echo Colors]. <ul style="list-style-type: none"> • 32 colors: [Off], [1] to [31]; default: [Off] • 16 colors: [Off], [1] to [15]; default: [Off] • 8 colors: [Off], [1] to [7]; default: [Off] |
| [Erase Color] | Erases echo colors on the display. The echoes are erased in order from weakest to strongest. | Setting range depends on setting for [Echo Colors]. <ul style="list-style-type: none"> • 32 colors: [Off], [1] to [30]; default: [Off] • 16 colors: [Off], [1] to [14]; default: [Off] • 8 colors: [Off], [1] to [6]; default: [Off] |
| [Echo Colors] | Sets the number of colors used to paint the picture. | [32], [16], [8]; default: [32] |
| [BCKD. Colors] | Selects the color scheme for the display. these colors can be adjusted from the [Color Settings] menu in the [System] menu (see section 5.8). | [1], [2], [3]; default: [2] |
| [Bearing] | Sets the reference to use for bearing. | [Relative], [True.]; default: [Relative] |
| [Heading] | Adjust the direction of ship's heading. Echo image rotates clockwise with positive value it rotates counterclockwise with negative value. | -180 to +179°; default [+0°] |
| [Roll Offset] | Adjust the roll offset angle of hull unit. The angle is offset to port with positive value. The angle is offset to starboard with negative value. | -10.0 to +10.0°; default [+0°] |
| [Pitch Offset] | Adjust the pitch offset angle of hull unit. The angle is offset to port with positive value. The angle is offset to starboard with negative value. | -10.0 to +10.0°; default [+0°] |
| [Sensor Correct] | Offset the motion sensor direction. The angle is offset to clockwise when positive value is selected. The angle is offset to counterclockwise when negative value is selected. | -180 to +179°; default [+0°] |

5.5 System Menu

The System menu contains settings which can be adjusted according to your preferences.

A simulation mode is also included to acquaint you with the many functions of the equipment. The simulation mode does not require a connected transducer.

How to access the System menu

1. Press the **MENU** key. The menu window appears.
2. Press **▲** to select the menu bar.
3. Press **◀** or **▶** to select [System].
4. Press **▼** to select [Go to SYS Menu].
5. Press **◀** to select [Yes]. The [System] menu appears.

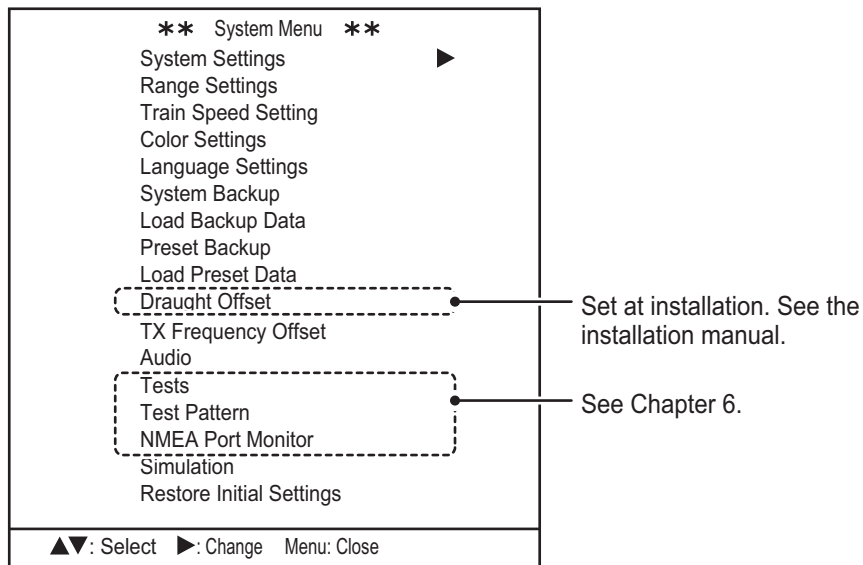

5.6 FUNC Key Menu

The system has three function keys which can be customized to suit your needs. Each key can be assigned either as a preset key, or as a short-cut key.

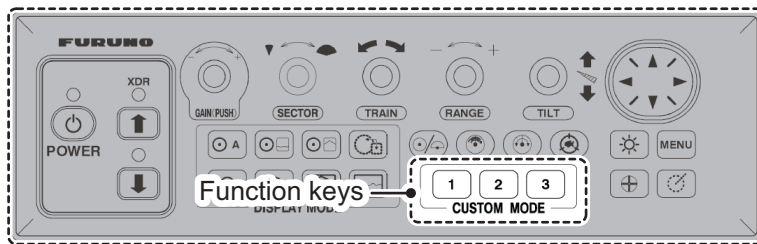

Preset keys store the display mode, sector, train angle, scan range, tilt angle, scan speed and gain. This allows you to preset for specific operations.

Short-cut keys provide quick access to preset functions. The short-cut key options are not changeable.

5.6.1 How to setup the function keys

To setup a function key, do the following:

1. Referring to section 5.5, access the [System] menu.
2. Press ▲ or ▼ to select [System Settings], then press ►. The [System Settings 1] menu appears.
3. Press ► to show the [System Setting 2] menu.
4. Press ▼ to select [FUNC Key1], [FUNC Key2] or [FUNC Key3], as required.
5. Press ► or ◀ to select [Preset Key] or [Short-Cut Key], as required.
6. Press the **MENU** key twice to close the menu.

5.6.2 Short-cut keys

You can select the function for each shortcut key as follows:

1. Referring to section 5.6.1, access the [FUNC Key] menu.
2. Press ▲ or ▼ to select the appropriate key.
3. Press ► or ◀ to select the required short-cut. The table below shows the options available for each key.

| Menu item | Settings | Description |
|-----------|--|---|
| [Key1] | [Preset Key] | Enable calling up the Preset key setting you have set. |
| [Key2] | <ul style="list-style-type: none"> • [VERT Search] • [Delete Mark] | <ul style="list-style-type: none"> • Enables the Vertical Search function. • Deletes all event marks. |
| [Key3] | <ul style="list-style-type: none"> • [VERT Search] • [Delete Mark] | <ul style="list-style-type: none"> • Enables the Vertical Search function. • Deletes all event marks. |

4. Press the **MENU** key to close the menu.

How to add menu short-cuts to the short-cut keys

To add a menu function as a short-cut, follow the procedure below.

Note: The function key used for this short-cut must be assigned as a [Short-Cut Key]. See section 5.6.1 for details.

1. Press the **MENU** key. The menu window appears.
2. Press **▲** to select the menu bar.
3. Press **◀** or **▶** to select the menu which has the function you want to add as a short-cut. The menus which contain function that can be added are: [COM1], [COM2], [HORI.], [VERT] and [ES].
4. Press **▼** or **▲** to select the function you want to add, then press the appropriate function key. A confirmation message appears.
5. Press the function selected at step 4 again. The function is registered as a short-cut.
6. Referring to section 5.6.1, access the [FUNC Key] menu and check that the function is registered.
7. Press the **MENU** key to close the menu.

Note: When the short-cut setting for a function key is changed to [VERT Search] or [Delete Mark], menu short-cuts are deleted. To re-register a menu function as a short-cut, repeat the above procedure.

5.6.3 Preset keys

You can adjust the preset keys suit your needs. To adjust the presets, do the following:

1. Set the display mode, sector, train angle, scan range, tilt angle, scan speed and gain to the settings you want to store. This will become the preset.
2. Referring to section 5.6.1, access the [FUNC Key] menu.
3. Press the appropriate function key. A guidance message is shown above the menu.

Note: The selected key must be setup as a [Preset Key]. See section 5.6.1.

4. Press the function key again to store the current display mode settings. The table below shows the pre-programmed (default) settings for each key.

| Menu item | Settings | |
|-----------|---|---|
| [Key1] | <ul style="list-style-type: none"> • Display mode: Horizontal (zoomed) • Sector setting: 240° • Train angle: 0° • Scan range: 160 m | <ul style="list-style-type: none"> • Tilt angle: 30° • Scan speed: 12° • Gain: 5.0 |
| [Key2] | <ul style="list-style-type: none"> • Display mode: Horizontal • Sector setting: 360° • Train angle: 0° • Scan range: 160 m | <ul style="list-style-type: none"> • Tilt angle: 30° • Scan speed: 12° • Gain: 5.0 |
| [Key3] | <ul style="list-style-type: none"> • Display mode: Vertical • Sector setting: 180° • Train angle: 90° • Scan range: 120 m | <ul style="list-style-type: none"> • Tilt angle: 90° • Scan speed: 6° • Gain: 5.0 |

5. Press the **MENU** key to close the menu.

5.7 How to Adjust the Preset Range Settings

The Range Settings menu contains the range presets. You can change the presets to suit your requirements as follows:

1. Referring to section 5.5, open the [System] menu.
2. Press ▼ to select [Range Settings], then press ► to open the [Range Settings] menu.

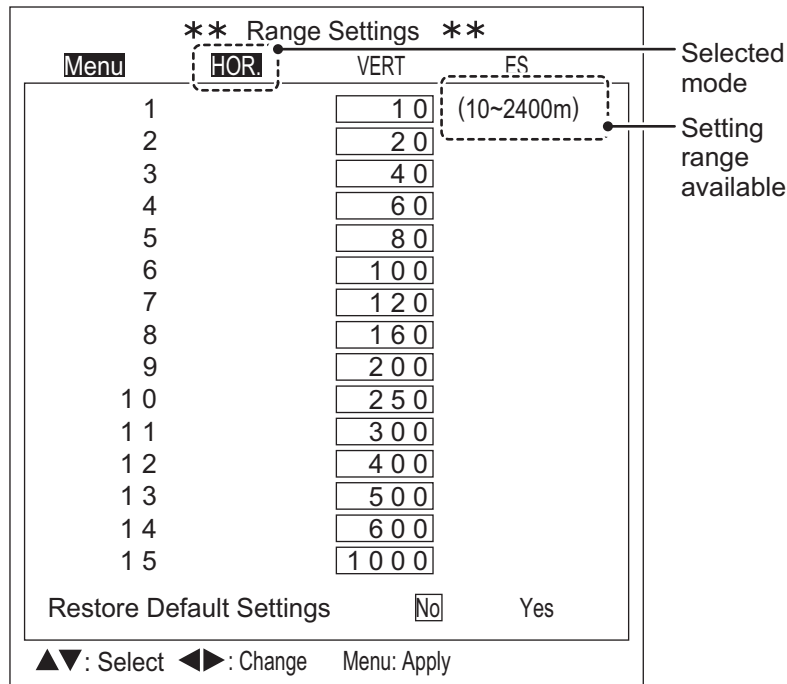

The available setting range for each mode is shown at the top-right of the menu window.

3. Press ► or ◀ to select the mode for which to change the preset range. The selected mode is highlighted in a manner similar to that indicated in the above figure.
4. Press ▼ or ▲ to select the preset number to change.
5. Press ► to increase the range or ◀ to decrease the range.
The range changes in five meter increments between 10 m and 100 m. Between 100 m and the maximum range, the range changes in ten meter increments.
6. Press the **MENU** key several times to close the menu.

How to restore the default range presets

You can restore the default preset ranges for each mode individually.

1. Referring to section 5.5, open the [System] menu.
2. Press ▼ to select [Range Settings], then press ► to open the [Range Settings] menu.
3. Press ▼ to select [Restore Default Settings], then press ►. A confirmation window appears.
4. Press ► to select [Yes], then press the **MENU** key.
To cancel the procedure, select [No], then press the **MENU** key.

5.8 How to Enable/Disable Train Speed Presets

The train speed button () has six preset settings, each of which can be activated, or deactivated, to suit your requirements.

To activate/deactivate a speed setting, do the following:

1. Referring to section 5.5, open the [System] menu.
2. Press ▼ to select [Train Speed Setting], then press ► to open the [Train Speed Setting] menu.

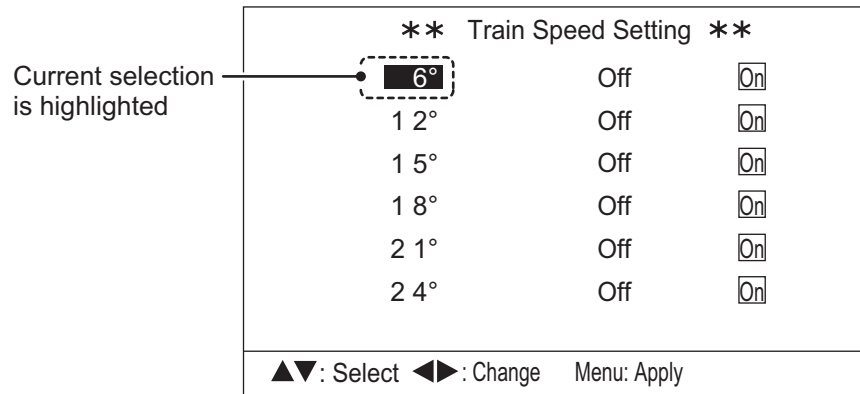

3. Press ▼ or ▲ to select a speed setting.
4. Press ► or ◀ to select [Off] (deactivate) or [On] (activate), as appropriate.
5. Press the **MENU** key twice to close the menu.

5.9 How to Change the Displayed Colors

You can customize the color settings for echoes, the display color scheme (background, menu and text colors) and the Full-circle A-Scope display mode.

To customize the colors, do the following:

1. Referring to section 5.5, open the [System] menu.
2. Press ▲ or ▼ to select [Color Settings]. The [Color Palette] window appears.

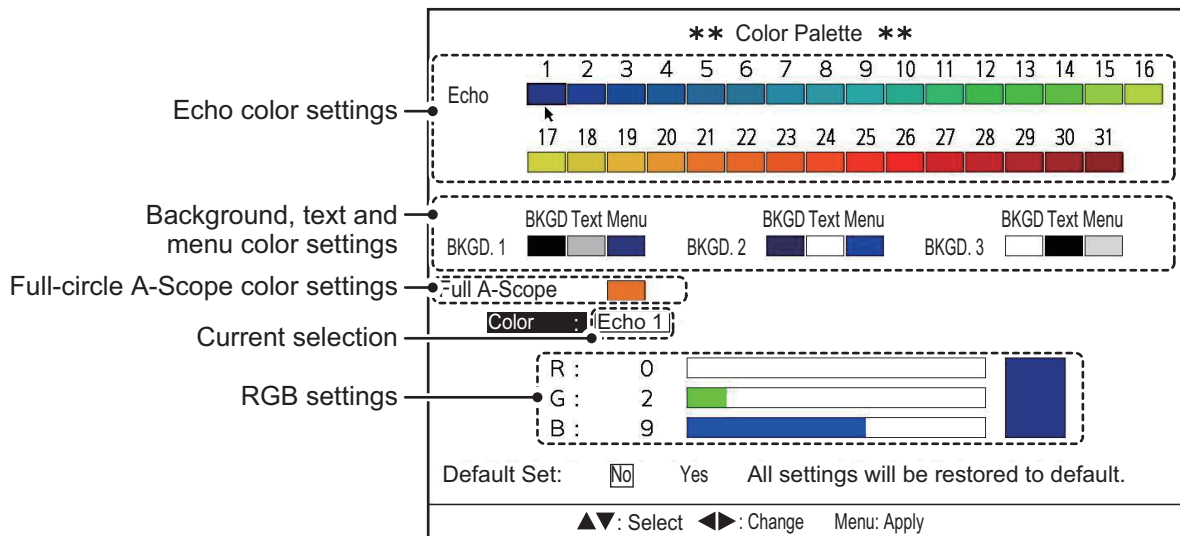

3. The cursor appears as shown in the figure above. Referring to the figure above and the table below, press ► or ◀ to move the cursor to the setting you wish to change. The currently selected item is also shown next to the [Color] indication at the lower half of the window.

| | |
|---------------------------|---|
| [Echo] | Changes the echo colors based on echo strength. The lowest setting ([1]) is the color for the weakest echoes. The highest setting ([31]) is the color for the strongest echoes. |
| [BKGD1], [BKGD2], [BKGD3] | Sets the color for each preset color scheme. [BKGD] sets the background color, [Text] sets the text color and [Menu] sets the menu background color. |
| [Full A-Scope] | Sets the base color for the Full-circle A-Scope display. This color does not affect the Horizontal or Echo Sounder side-display A-Scope. |
| [Color:] | The item currently selected by the cursor appears here. |
| RGB settings | Adjust the red, green and blue color saturation for the selected item. |
| [Default Set] | Restores the default color settings. |

4. Press ▲ or ▼ to select [R] (red), [G] (green) or [B] (blue).
5. Press ► to increase the color saturation, or press ◀ to decrease the color saturation. The current color mix appears in the palette window to the right of the RGB settings.
6. Repeat the procedure as required.

5.10 How to Backup/Restore Settings

The system can save either a full (System Backup) or partial (Preset Backup) backup.

The full backup saves all user customizations, including [System] menu settings.

The partial backup saves only the menu settings for the [COM1], [COM2], [HOR.], [VERT], [ES] and [FUNC Key] menus.

How to backup your settings

- Referring to section 5.5, open the [System] menu.
- Press ▼ or ▲ to select [System Backup] (full backup) or [Preset Backup] (partial backup), then press ►. A confirmation window appears. The example below shows the full backup confirmation window. Note that the title at the top of the window changes depending on your selection.

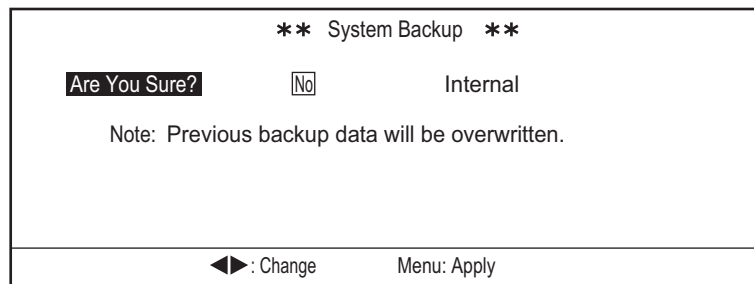

- Press ► or ◀ to select [No] or [Internal], as appropriate.
 - [No]: Backup is stopped, no settings are saved.
 - [Internal]: System settings are saved in the Transceiver Unit's internal memory.

5. MENU OPERATIONS

Note: Previous backup data will be overwritten.

4. Press the **MENU** key to backup the system settings. The system releases a series of beeps to indicate that the data is saved, then the [System] menu appears.
5. Press the **MENU** key to close the menu.

How to restore your settings

1. Referring to section 5.5, open the [System] menu.
2. Press ▼ or ▲ to select [Load Backup Data] (full system settings) or [Load Preset Data] (partial settings), then press ►. A confirmation window appears. The example below shows the full system settings confirmation window. Note that the title at the top of the window changes depending on your selection.

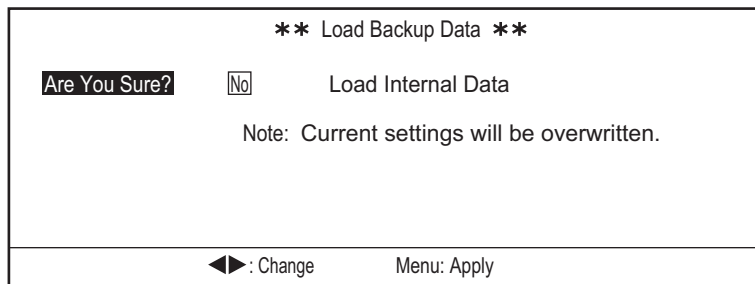

3. Press ► or ◀ to select [No] or [Load Internal Data], as appropriate.
 - [No]: No backup data is loaded, settings remain unchanged.
 - [Load Internal Data]: System settings are loaded from the Transceiver Unit's internal memory and replace the current settings.
4. Press the **MENU** key to load the system settings. The system releases a series of beeps to indicate that the data is saved, then the [System] menu appears.
5. Press the **MENU** key to close the menu.

5.11 How to Adjust the Transmission Frequency

If the system is receiving interference from a video sounder to other sonar on your ship, adjust the frequency to reduce interference.

1. Referring to section 5.5, open the [System] menu.
2. Press ▲ or ▼ to select [TX Frequency Offset], then press ►. The [TX FREQ. Adjust] window appears.

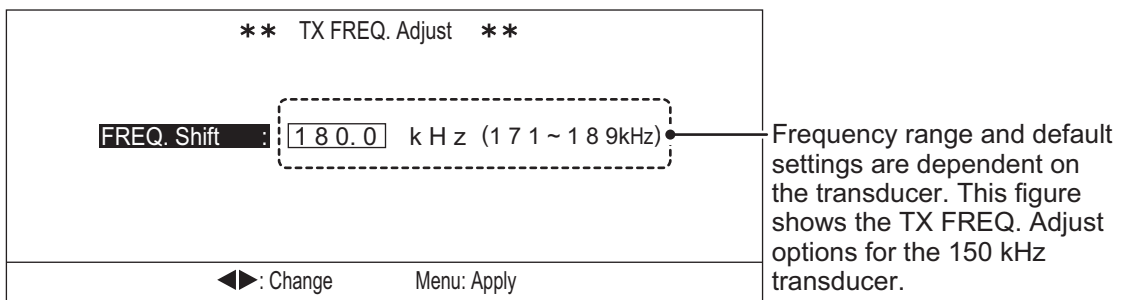

3. Press ► to increase the transmission frequency, or press ◀ to decrease the transmission frequency.
4. Press the **MENU** key twice to close the menu.

5.12 How to Adjust the Speaker Settings

The optional speaker is available for use with your CH-500/CH-600. By connecting a speaker, you can “hear” fish echoes, which allows you to move about your ship freely while fishing.

You can change the following settings for the speaker: output frequency, output bandwidth, harmonic pattern and doppler shift filter.

In most cases, these settings are done during the first voyage after installation, and require almost no adjustment once set.

5.12.1 How to adjust the speaker frequency

To adjust the output frequency for the speaker, do the following:

1. Referring to section 5.5, open the [System] menu.
2. Press ▼ or ▲ to select [Audio], then press ►. The [Audio] settings window appears.

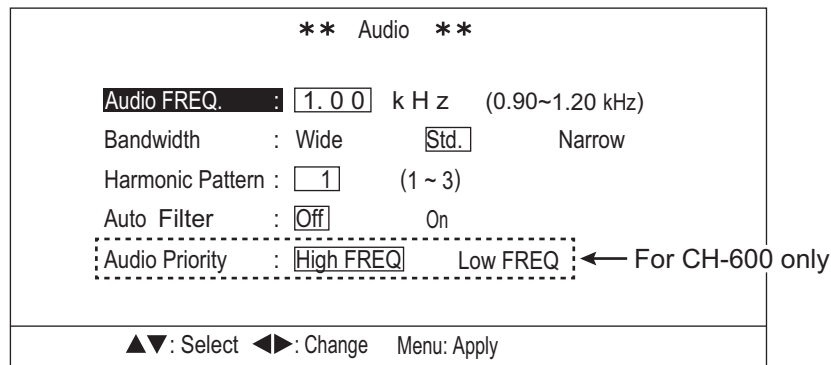

3. [Audio FREQ.] is already selected. Press ► or ◀ to show adjust the frequency. The available range is 0.90 kHz to 1.20 kHz.
4. Press the **MENU** key twice to close the menu.

5.12.2 How to select the speaker bandwidth

You can customize the sound bandwidth to suit your preferences.

To set the output bandwidth, do the following:

1. Referring to section 5.5, open the [System] menu.
2. Press ▼ or ▲ to select [Audio], then press ►. The [Audio] settings window appears.
3. Press ▲ or ▼ to select [Bandwidth].
4. Press ► or ◀ to select the required bandwidth. The available options are:
 - [Wide]: Sound output is based on a wide bandwidth. Auto Filter settings are more effective with this setting.
 - [Std.]: Default setting. Sound output is based on a normal bandwidth. Auto Filter settings are effective with this setting.
 - [Narrow]: Sound output is based on a narrow bandwidth. Auto Filter settings have low effect with this setting.
5. Press the **MENU** key twice to close the menu.

5.12.3 How to set the harmonic pattern

You can customize the sound output to suit your preferences.

To adjust the harmonic pattern, do the following:

1. Referring to section 5.5, open the [System] menu.
2. Press ▼ or ▲ to select [Audio], then press ►. The [Audio] settings window appears.
3. Press ▲ or ▼ to select [Harmonic Pattern].
4. Press ► or ◀ to select the desired pattern.
The available options are: [1], [2] and [3].
5. Press the **MENU** key twice to close the menu.

5.12.4 How to filter for doppler shift

You can filter the sound output to compensate for doppler shift, created by your ship when in motion, or a moving school of fish.

To enable or disable the auto filter, do the following:

1. Referring to section 5.5, open the [System] menu.
2. Press ▼ or ▲ to select [Audio], then press ►. The [Audio] settings window appears.
3. Press ▲ or ▼ to select [Auto Filter].
4. Press ► or ◀ to select [Off] (disable the filter) or [On] (enable the filter). The output sound is affected in the following manner:
 - [Off]: Doppler shift is not compensated. Detected echoes are output with the sound level increasing incrementally for echoes moving toward the ship, and decreasing incrementally for echoes moving away from the ship.
 - [On]: Doppler shift is compensated. Echoes are output in the same manner, regardless of direction.

Note: The filter is only applied to doppler shift from fish echoes and own ship movement. It does not affect doppler shift from other sources.
5. Press the **MENU** key twice to close the menu.

5.12.5 How output sound based on frequency (CH-600 only)

You can select which frequency echoes are given output priority to your speaker.

1. Referring to section 5.5, open the [System] menu.
2. Press ▼ or ▲ to select [Audio], then press ►. The [Audio] settings window appears.
3. Press ▲ or ▼ to select [Audio Priority].
4. Press ► or ◀ to select the desired frequency.
The available options are: [High FREQ] and [Low FREQ].
5. Press the **MENU** key twice to close the menu.

5.13 How to Use the Simulation Mode

The simulation mode uses internal data to portray echoes on the screen and give you a better idea of how come functions and settings work.

The simulation mode does not require connection to a transducer and all sonar functions are available.

Note 1: During simulation, the system will not detect any actual echoes. Do not use the simulation mode when underway, for safety.

Note 2: When the simulation mode is active, the indication "SIM" appears at the top of the screen.

To start or stop the simulation mode, do the following:

1. Referring to section 5.5, open the [System] menu.
2. Press ▼ or ▲ to select [Simulation], then press ►. The [Simulation] settings window appears.

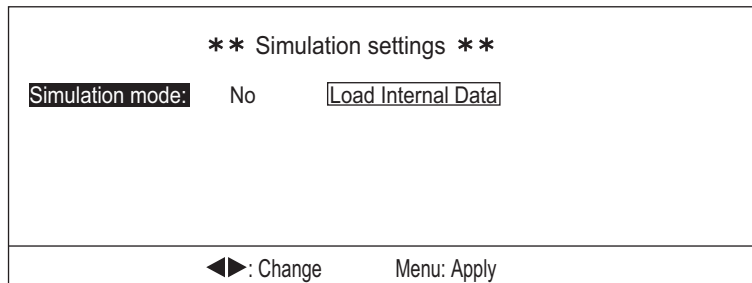

3. Press ► or ◀ to select the appropriate option.
 - [No]: Simulation is stopped, normal operations and functions are all available.
 - [Load Internal Data]: Start the simulation using data stored in the Transceiver Unit.
4. Press the **MENU** key to confirm the selection and either start or stop the simulation.
5. Press the **MENU** key again to close the menu.

5.14 How to Restore the System Menu to Default Settings

You can restore all the [System] menu settings to default settings at any time.

Note: All user settings and customizations in the [System] menu and sub-menus are lost when this procedure is completed. Settings for [COM1], [COM2], [HOR.], [VERT], [ES] and [FUNC Key] menus are not affected.

To restore the default settings, do the following:

1. Referring to section 5.5, open the [System] menu.
2. Press ▼ or ▲ to select [Restore Initial Settings], then press ►. The confirmation window shown below appears.

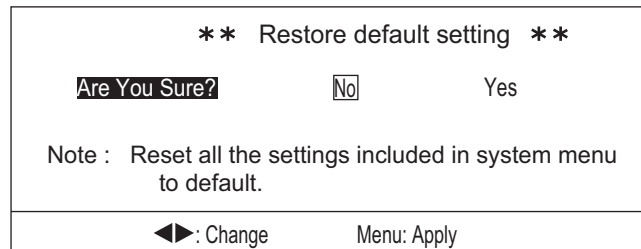

3. Press ► or ◀ to select the appropriate option.
 - [No]: Current settings remain unchanged.
 - [Yes]: Restores the [System] menu and all sub-menus to factory default settings.

5.15 System Settings menu

The System Settings menu contains two sub-menus. The settings in these menus rarely require adjustment once set, further, some of the menu items listed below are set at installation and should require no adjustment.

The following tables list the contents of the [System Setting] menu, together with a brief description for each menu item.

System Setting 1 tab

| Menu item | Description |
|-----------------------|--|
| [Position Display]* | Sets the reference point for position to be displayed on the screen. Select [Ship's L/L] to show the current location of the ship or [Cursor L/L] to show the coordinates for the cursor location. The navigational data (heading) and the longitude and latitude of own ship is required to show the longitude and latitude of the cursor. |
| [Track]* | Select [On] to show own ship track, or [Off] to hide the track. |
| [Current Data] | Show or hide the tidal current vector. Select [Off] to hide the vector, [Inbound] to show the vector for tidal currents moving towards your ship or [Outbound] to show the vector for tidal currents moving away from your ship |
| [Heading Indication]* | Sets the reference for heading display. Select either [True] or [Azimuth] as appropriate. |
| [Display Range Ring] | Show or hide the range rings. Select [Off] to hide, or [On] to show the rings. |
| [North Mark] | Show or hide the NORTH mark. Select [Off] to hide, or [On] to show the mark. |
| [CSE. Data]* | Sets the source for course data. Select [Nav.] to show course data from a navigator (NAVpilot, etc) or [Gyro] to show course data from a gyrocompass. |
| [Nav. Data]* | Sets the source for navigational data. Select [GPS] to show nav data from a GPS device, or [Other] to show nav data from a source other than a GPS device. |
| [NMEA1 Baudrate] | Sets the baud rate for the selected port. |
| [NMEA2 Baudrate] | Select from [4800], [9600], [19200] or [38400], as appropriate. |
| [TVG Correction] | Sets the level for automatic TVG correction. Select [Off] to disable automatic TVG, [1/2] or [1/1] to automatically adjust the TVG accordingly. |
| Units | Sets the unit of measurement to use when showing depth. Select the appropriate unit from [m] (meters), [ft] (feet), [fm] (fathoms), [HR] (HIRO) or [pb] (passi/braza). |
| [Temp Display]* | Sets the unit of measurement for temperature. Select either [°C] or [°F] as appropriate. |
| [Temp Graph]* | Shows or hides the temperature graph. Select [Off] to hide the graph, [20 min] or [60 min] to show a graph for the appropriate period of time. |
| [TLL Output] | Select [Off] to disable TLL output or [On] to enable TLL output to external equipment. |

*: Requires connection to appropriate sensors.

5. MENU OPERATIONS

System Setting 2 tab

| Menu item | Description |
|------------------------|--|
| [Gain Setting Protect] | Select [Off] to disable gain setting protection, or [On] to enable protection. |
| [Emphasis Mode] | Sets the method of smoothing (emphasis) for the displayed echoes. Select from [Off] (no echo picture adjustment), [Normal] (echoes are shown with evenly, based on strength) or [Red] (emphasizes the stronger echoes only). |
| [Stabilizer] | Sets the method of compensation for roll/pitch. Select from: <ul style="list-style-type: none"> • [Off]: disabled. • [On(Std.)]: use the data from the built-in motion sensor. (Recommended). • [On(Gyro)]: use only the angular velocity data from the built-in motion sensor. |
| [Auto Retract] | Sets the speed to activate the auto retraction feature for the hull unit. Select [Off] (disabled) or set the required speed at which to automatically retract the hull unit. Note: The maximum speed allowable while the hull unit is retracted is 15 knots. If the vessel has rapid acceleration capabilities, it is mandatory to set Auto Retract between 10 knots to 12 knots. |
| [Speed Alarm/Message]* | The speed alarm and message are a useful tool to help avoid damage to the hull unit caused by excessive speed. This function enables or disables the speed alarm. Select [Off] to disable the alarm and message, or [On] to enable the alarm and message. When this setting is enabled, lowering or retracting the hull unit at speeds over 15 knots will trigger the alarm and display a an alarm message. |
| [Sweep Indicator] | Sets the display method for the train position/tilt angle. Select either [Dot] (hashed line) or [Line] (solid line) as required. |
| [Menu BKGD. Transp.] | Sets the transparency level for the menu. Select [Off] (menu is displayed with a solid background, covering all echoes behind the menu) or select the appropriate level of transparency from [1] (menu background is slightly transparent) to [5] (menu background is highly transparent). |
| FUNC Key1/2/3 | See section 5.6. |
| Default Settings | Resets the system to default settings. Select [No] to keep current settings, [Yes] to restore all settings to default. Note: This function clears all user settings, menu settings and all customizations. |

*: Requires connection to appropriate sensors.

System Setting 3 tab

| Menu item | Description |
|---------------------|--|
| [HOR./HISTORY] | Select HORIZONTAL/HISTORY display mode. See section 1.5. |
| [HOR./VERT.] | Select HORIZONTAL/VERTICAL SCAN display mode. See section 1.5. |
| [HOR./VERT ZOOM] | Select HORIZONTAL/VERTICAL ZOOM display mode. See section 1.5. |
| [Full A-Scope] | Select Full-circle A-Scope display mode. See section 1.5. |
| [HOR./Full A-Scope] | Select Full-circle A-Scope + Horizontal display mode. See section 1.5. |

6. MAINTENANCE, TROUBLE-SHOOTING

This chapter provides information necessary to keep the equipment in working order.



6.1 Preventative Maintenance

Check the following items monthly.

- Check cables. If a cable is damaged, replace it.
- Check the connectors at the rear of each unit. Clean the connectors if necessary.
- Check the earth (grounding) for each unit. Clean or replace if necessary.
- Check the voltage of the ship's mains to make sure it is within range of the equipment's power rating.

6.2 How to Clean the Equipment

Dust or dirt can be removed from the equipment with a soft, dry cloth.

Do not use chemical cleaners to clean the equipment, they can remove paint and markings.

The LCD will, in time, accumulate a coating of dust which tends to dim the picture. Wipe LCD lightly with soft cloth to remove dust.

6.3 Hull Unit Maintenance

6.3.1 Hull unit lubrication

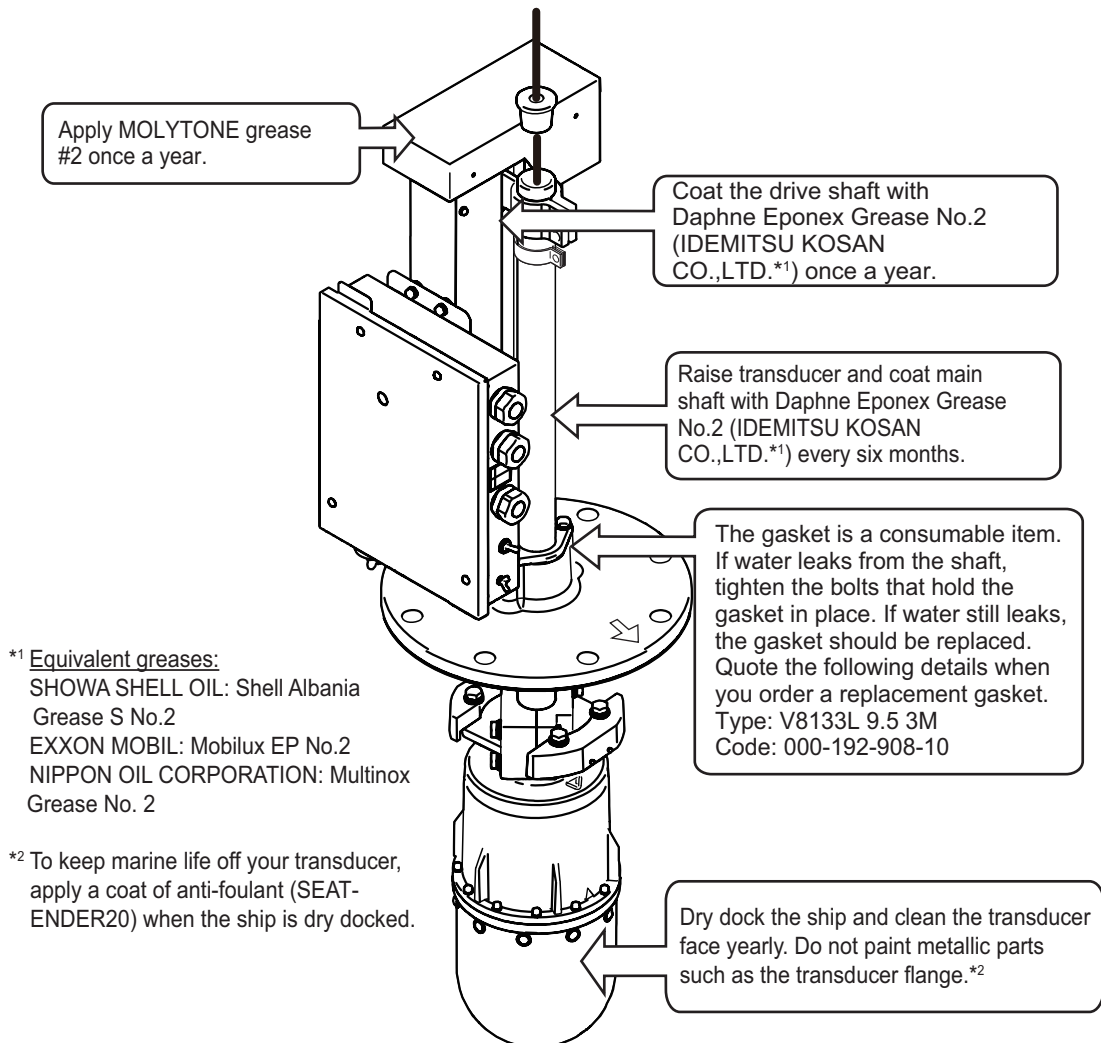

6.3.2 Manually raise/lower the transducer

WARNING

Turn off the power at the ship's mains switchboard before conducting the procedure below.

The motor can cause injury when rotating.

1. Turn off the breaker on the hull unit.
2. Turn the nut with a 19 mm ratchet wrench.

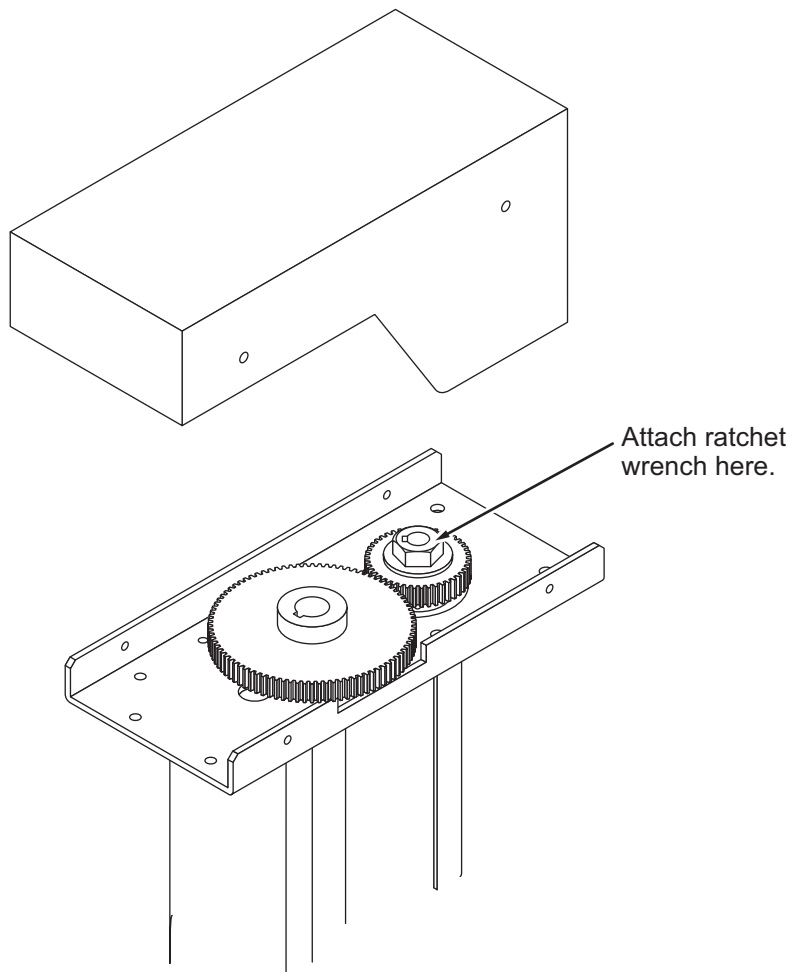

3. Check that the transducer raises and lowers smoothly, from the upper limit to the lower limit positions. If the transducer cannot be raised/lowered smoothly, do not use excessive force; the shaft may bend, causing damage to other components.
4. Check the soundome and tank. Remove any marine life with fine sandpaper or a piece of wood.

6.4 Transducer Maintenance

When the ship is dry-docked, remove marine growth from the transducer with fine sandpaper or a piece of wood.

| NOTICE |
|---|
| <p>Do not paint the transducer face with substances other than anti-foulant.</p> <p>Loss of sensitivity will result.</p> |
| <p>Do not use plastic solvents to clean the transducer.</p> <p>They can damage the transducer.</p> |

6.5 How to Replace the Fuses

|  WARNING |
|---|
| <p>Use the proper fuse.</p> <p>Use of the wrong fuse can cause fire or damage the equipment.</p> |

The fuse in the hull and transceiver units protect them from overvoltage, equipment fault and reverse polarity of the ship's mains. If the power cannot be applied first check that the power cable between the transceiver unit and the display unit is firmly connected. If the power still cannot be applied, the fuse in the transceiver unit may have blown.

Have a qualified technician check and change the fuse.

| Unit | Fuse type | Code No. |
|------------------|------------------|-----------------|
| Transceiver Unit | FGMB 125V 8A | 000-191-004-10 |
| Hull Unit | 0287010.U | 000-193-054-10 |
| | FGMB 125V 6A | 000-157-492-10 |

6.6 Troubleshooting

The following table lists common symptoms of equipment trouble and possible means to rectify them.

| Symptom | Checks and remedies |
|---|---|
| Cannot turn the power on. | <ul style="list-style-type: none"> • Check the cable between the transceiver unit and the display unit. Re-connect or fasten as appropriate. • Check that the transceiver is turned on. • Check the ship's mains. • Have a qualified technician check the fuses. • Make sure the power button makes a "click" sound when you press it. If the power button is not pressed sufficiently, the power will not turn on. |
| Cannot turn the power off. | <ul style="list-style-type: none"> • Check the cable between the transceiver unit and the display unit. Re-connect or fasten as appropriate. • Check that the control unit used to turn the power off is the same as the one used to turn the power on. • Make sure the power button makes a "click" sound when you press it. If the power button is not pressed sufficiently, the power will not turn off. |
| Seabed echo becomes irregular. | <ul style="list-style-type: none"> • Rough seas. The distance to the seabed changes dramatically due to pitching and/or rolling. • Long range selected. Transmission period is long, which causes pitching/rolling to affect echo detection. |
| Weak echoes. | <ul style="list-style-type: none"> • Output power is set to [Low]. Change the output power to [High] from the [COM1] menu. • TVG setting is excessively high. Adjust the TVG setting from the appropriate display mode menu. Also note that TVG requires readjustment when the gain setting is changed. |
| Screen color appears strange. | <ul style="list-style-type: none"> • The brilliance setting may be too low. Adjust the brilliance referring to section 1.4. |
| Picture contains noise. | <ul style="list-style-type: none"> • The equipment may not be grounded correctly. Check the ground (earth) for the equipment. • Power cable is too close to the signal cable. Relocate the power cable or the signal cable. • Debris may be on the sea surface. Turn the [Interference] on from the [COM1] menu. |
| Picture does not change when the tilt angle is adjusted. (Seabed does not appear in the vertical scan when the seabed is flat.) | <ul style="list-style-type: none"> • There may be a problem with the tilt mechanism or the tilt control line. Contact your local dealer for advice. |
| Water leakage from the hull unit's shaft flange. | <ul style="list-style-type: none"> • Wipe the area dry, then check the area around the gasket retaining plate. If water is leaking from the retaining plate, tighten the bolts. • If water still leaks after the above checks and remedies, the gasket may require replacement. Contact your local dealer and request service/replacement. See section 6.3.1 for part details. <p>Note: When the hull unit no longer leaks, check that the main shaft can move freely and adjust as necessary.</p> |

6.7 Error Messages

There are several error messages which may appear on the screen, for various reasons. All error messages are accompanied by an audio alarm.

You can silence the audio alarm by pressing the **EVENT MARK** key ().

The following table lists the possible errors messages, together a possible reason and remedy.

| Error | Possible meaning, remedy |
|--|--|
| Raise/lower function has stopped. Slow down under 15 knots, and please try to raise or lower the soundome. If the message appears again, turn off the hull unit and raise or lower manually. | You attempted to raise or lower the soundome when the ship speed is higher than 15 knots, or the breaker on the hull unit is tripped. Check the breaker and lower the ship speed to below 15 knots, then try to raise/lower the soundome again. If the same error is repeated, turn the hull unit off, raise the soundome manually, then conduct the hull unit diagnostic test outlined in section 6.3.2. |
| Raise/lower function has not finished. Maximum allowable speed is 15 knots while soundome is being retracted. | |
| Ship speed in excess of 15 knots. Slow down under 15 knots when moving transducer unit. | |
| Hull unit power off. Turn off the hull unit power, then check the breaker and fuse. | <ul style="list-style-type: none"> • There is no power supplied to the hull unit. The breaker may be tripped or the fuse inside the hull unit is blown. Check that the power is on. If the hull unit is not turned on, turn the power on, then press the EVENT MARK key. If the hull unit power is on, turn the power off, then consult your local dealer. • Power cable is loose or disconnected. Check the power cable connections. Fasten or reconnect as necessary. |
| Hull unit power off. Check hull unit power's fuse and switch. | |
| Frequency error. Check hull unit. | Unable to detect the frequency. Silence the alarm, then check the hull unit connections and power. If the connections are correct and the power is on, but the problem persists, consult your local dealer. |
| Train Tilt error. Check hull unit's connections and power. | The system cannot detect the bow direction or there is a problem with the train/tilt motor. Check the motor and replace if necessary. |
| Transducer is lowered. Reduce ship's speed and press ↑ key to retract transducer. | You attempted to maneuver the ship, at speeds of more than 20 knots, with the transducer still lowered. Reduce ship speed to below 15 knots, then try again. |
| No external KP input. Check connection to external synchronous device. | Keying pulse signal from an external source has stopped or was interrupted. Check the connections to, and status of, the external device. |
| 06P0289 (ANLG) does not match the frequency of the transducer. Check PCB version. | Unmatched transducer frequency may cause a fault to the 06P0289 (ANLG) board. Consult your local dealer. |

6.8 Diagnostics

6.8.1 How to perform a full system test

The [Tests] function conducts a comprehensive test on the transceiver unit, monitor unit and the control panel.

To begin a diagnostic test, do the following:

1. Referring to section 5.5, open the [System] menu.
2. Press ▼ or ▲ to select [Tests], then press ►. The system test results window appears.

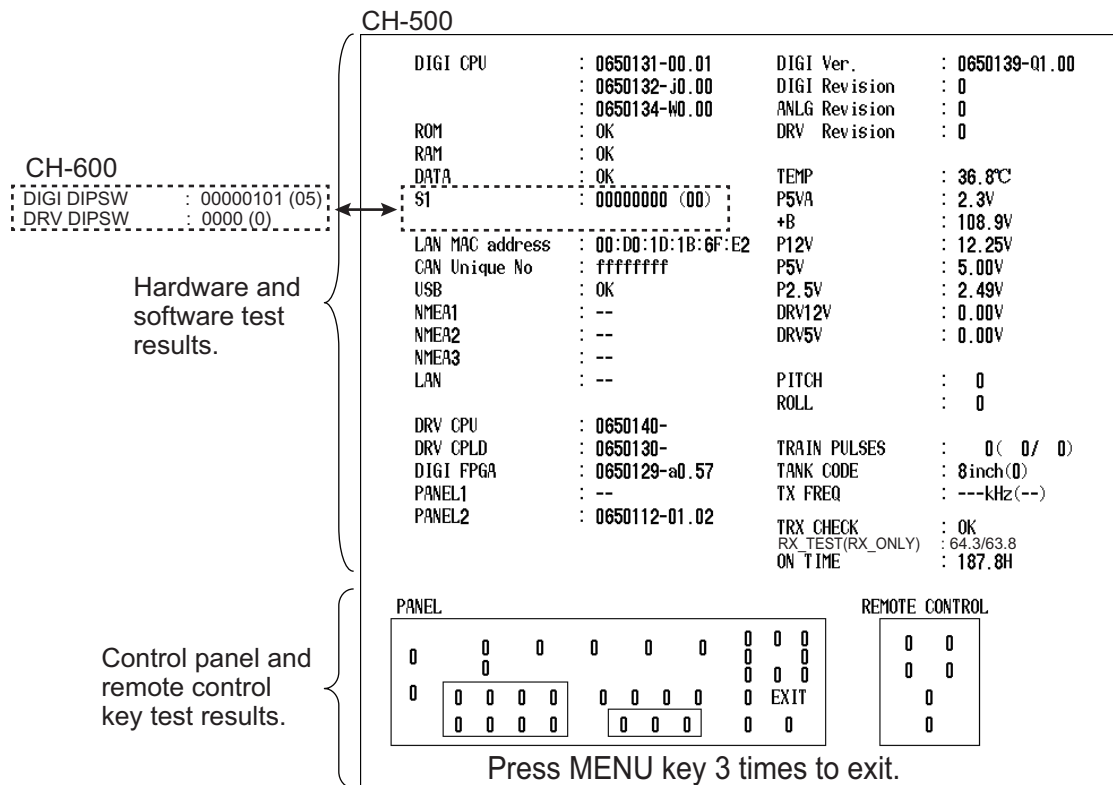

3. After a few moments, the hardware and software results should appear in the window. Check that no items show the result as "NG" (Not Good). If any item shows "NG" contact your local dealer for advice.
4. Press each key on the panel and remote control. The indication for each key should change from "0" to "1" when the key is pressed. When the key is released, the indication should change back to "0". If the indication does not change, there may be a problem with the control panel. Contact your dealer for advice.
5. To exit the diagnostic test, press the **MENU** key three times, in quick succession.

6.8.2 How to test the LCD

The Test Pattern function checks the LCD colors.

To check the LCD, do the following:

1. Referring to section 5.5, open the [System] menu.
2. Press ▼ or ▲ to select [Test Pattern], then press ►. The LCD test starts and the message "Press ► to change test pattern. Press MENU key to exit." appears at the bottom of the screen.
3. Press ► to cycle through the screens in the order shown below.

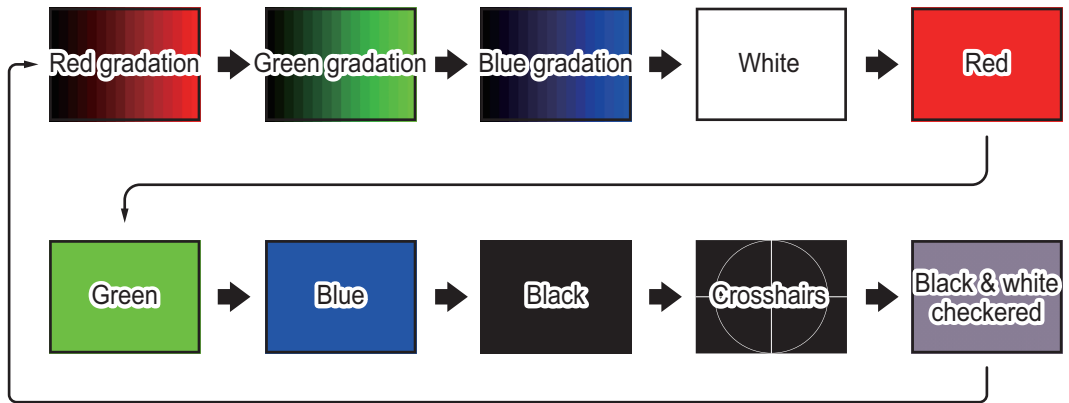

6.9 How to Remove and Re-install the Display Unit

During the off-season, or if your ship is not used for a lengthy period of time, you can remove the display unit for security.

6.9.1 How to remove the display unit

1. Disconnect all cables connected to the display unit.
2. Cover the connector ends with vinyl tape to prevent foreign objects entering the connectors. Also, cover the tape cable ends with a plastic bag, sealed at the cable with vinyl tape, to prevent water intrusion.
3. Unfasten the knobs on the display unit (one per side).

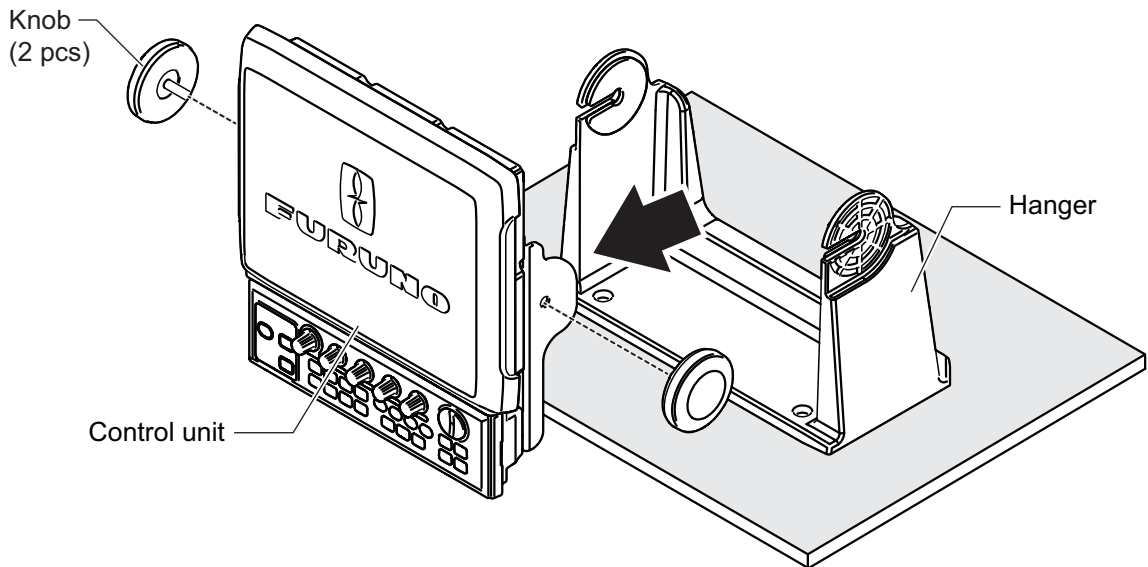

4. Remove the display unit from the hanger.

6.9.2 How to re-install the display unit

1. Place the display unit in the hanger. Make sure that the display unit is facing in the correct direction.
2. Fasten the knobs to the hanger (one per side).
3. Uncover the cable connector ends. Check that each connector is clean and has no foreign objects inside.
4. Connect all required cables to the display unit.
5. Fasten all cables firmly.

6. MAINTENANCE, TROUBLESHOOTING

This page is intentionally left blank.

APPENDIX 1 MENU TREE

CH-500/CH-600

Main menu

- | COM1 1
- | COM2 2
- | HOR. 3
- | VERT 4
- | ES 5
- | FUNC Key 6
- | System 7

CH-500

Bold Italic : Default

1 COM1

- | TX Power (***High***, Low)
- | TX Pulselength (***Long***, Short)
- | TX Rate (EXT., 1 to 10; default: ***10***)
- | Interference (***Off***, On)
- | AGC (***0***, 1, 2, 3, 4, 5)
- | Auto Filter (Wide, ***Std.***, Narrow)
- | Reverberation (***Off***, On)
- | Volume (0.0 to 10.0, default: ***0.0***)

2 COM2

- | Delete Track (***No***, Yes)
- | White Marker (Off, 1 to 31; default: ***Off***)
- | Erase Color (Off, 1 to 30; default: ***Off***)
- | Echo Colors (***32***, 16, 8)
- | BKGD. Colors (1, ***2***, 3)
- | Bearing (***Relative***, True)
- | Heading (-180 to +179°; default: ***+0°***)
- | Roll Offset (-10.0 to +10.0; default: ***+0.0°***)
- | Pitch Offset (-10.0 to +10.0; default: ***+0.0°***)
- | Sensor Correct (-180 to +179°; default: ***+0°***)

3 HOR.

- | TVG Level (0.0 to 10.0; default: ***4.0***)
- | TVG Distance (0.0 to 10.0; default: ***4.0***)
- | Gain ADJ. (-10 to +10; default: ***0***)
- | RES. Color (***LOG***, Linear, Square, Cube)
- | Clutter (***0***, 1, 2, 3)
- | Tracking Key (Position, ***Echo***, Reverse)
- | Tracking Mode (***Auto***, Manual)
- | Auto Tilt (***Off***, ±2°, ±4°, ±6°, ±10°)
- | A-Scope (***Off***, On)

4 VERT

- | TVG Level (0.0 to 10.0; default: ***4.0***)
- | TVG Distance (0.0 to 10.0; default: ***4.0***)
- | Gain ADJ. (-10 to +10; default: ***0***)
- | RES. Color (***LOG***, Linear, Square, Cube)
- | Clutter (***0***, 1, 2, 3)
- | HOR. Range (***×1***, ×2)

APPENDIX 1 MENU TREE

5 ES

- | TVG Level (0.0 to 10.0; default: **4.0**)
- | TVG Distance (0.0 to 10.0; default: **4.0**)
- | Gain ADJ. (-10 to +10; default: **0**)
- | RES. Color (**LOG**, Linear, Square, Cube)
- | Clutter (**0**, 1, 2, 3)
- | A-Scope (**Off**, On)

6 FUNC Key

- | Key1 (Preset Key)
- | Key2 (**VERT Search**, Delete Mark)
- | Key3 (VERT Search, **Delete Mark**)

7 System

- | System Setting
 - | System Setting 1
 - | Positon Display (**Ship's L/L**, Cursor L/L)
 - | Track (Off, **On**)
 - | Current Data (**Off**, Inbound, Outbound)
 - | Heading Indication (**True**, Azimuth)
 - | Display Range Ring (Off, **On**)
 - | North Mark (**Off**, On)
 - | CSE. Data (**Nav.**, Gyro)
 - | Nav. Data (**GPS**, Other)
 - | NMEA1 Baudrate (**4800**, 9600, 19200, 38400)
 - | NMEA2 Baudrate (**4800**, 9600, 19200, 38400)
 - | TVG Correction (**Off**, 1/2, 1/1)
 - | Units (**m**, ft, fm, HR, pb)
 - | Temp Display (**°C**, °F)
 - | Temp Graph (**Off**, 20min, 60min)
 - | TLL Output (**Off**, On)
 - | System Setting 2
 - | Gain Setting Protect (**Off**, On)
 - | Emphasis Mode (Off, **Normal**, Red)
 - | Stabilizer (Off, **On(Std.)**, On(Gyro))
 - | Auto Retract (Off, 5 to 15; default: **Off**)
 - | Speed Alarm Message (Off, **On**)
 - | Sweep Indicator (Dot, **Line**)
 - | Menu BKGD. Transp. (Off, 1 to 5; default: **5**)
 - | FUNC Key1 (Preset Key, **Short-Cut Key**)
 - | FUNC Key2 (Preset Key, Short-Cut Key)
 - | FUNC Key3 (Preset Key, Short-Cut Key)
 - | Default Settings (**No**, Yes)

(Continued on next page)

(Continued from previous page)

- Range Settings
 - HOR. (All defaults shown below)
 - m: 10, 20, 40, 60, 80, 120, 160, 200, 250, 300, 400, 500, 600, 800, 1000
 - ft: 40, 80, 120, 200, 300, 400, 500, 600, 700, 800, 1000, 1500, 2000, 2500, 3500
 - fm: 10, 20, 30, 40, 60, 80, 100, 120, 140, 160, 200, 250, 300, 400, 500
 - HR: 10, 20, 40, 60, 80, 100, 120, 140, 160, 200, 250, 300, 400, 500, 700
 - pb: 10, 20, 40, 60, 80, 100, 120, 140, 160, 200, 250, 300, 400, 500, 700
 - VERT (All defaults shown below)
 - m: 10, 20, 30, 40, 60, 80, 100, 120, 160, 200, 250, 300, 400, 500, 600
 - ft: 30, 60, 90, 120, 150, 200, 250, 300, 400, 500, 600, 800, 1000, 1500, 2000
 - fm: 10, 20, 30, 40, 50, 60, 80, 100, 120, 140, 160, 200, 250, 300, 400
 - HR: 10, 20, 30, 40, 50, 60, 80, 100, 120, 140, 160, 200, 250, 300, 400
 - pb: 10, 20, 30, 40, 50, 60, 80, 100, 120, 140, 160, 200, 250, 300, 400
 - ES (All defaults shown below)
 - m: 10, 20, 30, 40, 60, 80, 100, 120, 160, 200, 250, 300, 400, 500, 600
 - ft: 30, 60, 90, 120, 150, 200, 250, 300, 400, 500, 600, 800, 1000, 1500, 2000
 - fm: 10, 20, 30, 40, 50, 60, 80, 100, 120, 140, 160, 200, 250, 300, 400
 - HR: 10, 20, 30, 40, 50, 60, 80, 100, 120, 140, 160, 200, 250, 300, 400
 - pb: 10, 20, 30, 40, 50, 60, 80, 100, 120, 140, 160, 200, 250, 300, 400
- Train Speed Setting
 - 6° (Off, **On**)
 - 12° (Off, **On**)
 - 15° (Off, **On**)
 - 18° (Off, **On**)
 - 21° (Off, **On**)
 - 24° (Off, **On**)
- Color Settings (Opens Color Palette)
- Language Settings (Japanese, **English**, Thai, Vietnamese, Chinese, Spanish, Indonesian, Malay, Burmese, French, Norwegian, Italian, Greek)
- System Backup (**No**, Internal)
- Load Backup Data (**No**, Load Internal Data)
- Preset Backup (**No**, Internal)
- Load Preset Data (**No**, Load Internal Data)
- Draught Offset
 - Draught (-5.0 m to 60.0 m; default: **0.0 m**)
 - Hull Unit Stroke (0 mm to 400 mm; default **400 mm**)
- TX Frequency Offset
 - FREQ. Shift (Range and default dependent on transducer)
- Audio
 - Audio FREQ. (0.90 kHz to 1.20 kHz; default: **1.00 kHz**)
 - Bandwidth (Wide, **Std.**, Narrow)
 - Harmonic Pattern (**1**, 2, 3)
 - Auto Filter (**Off**, On)
- Tests (Starts diagnostic test)
- Test Pattern (Starts LCD test)
- NMEA Port Monitor (Starts port monitor)
- Simulation
 - Simulation Mode (**No**, Load Internal Data)
- Restore Initial Settings (**No**, Yes)

APPENDIX 1 MENU TREE

CH-600

Bold Italic : Default

1 COM1

- | TX Power (***High***, Low)
- | TX Pulselength (***Long***, Short)
- | TX Rate (EXT., 1 to 10; default: ***10***)
- | Interference LF (***Off***, On)
- | Interference HF (***Off***, On)
- | AGC-LF (***0***, 1, 2, 3, 4, 5)
- | AGC-HF (***0***, 1, 2, 3, 4, 5)
- | Auto Filter-LF (Wide, ***Std.***, Narrow)
- | Auto Filter-HF (Wide, ***Std.***, Narrow)
- | Reverberation (***Off***, On)
- | Volume (0.0 to 10.0, default: ***0.0***)

2 COM2

- | Delete Track (***No***, Yes)
- | Mix Mode (***Std.***, Compress)
- | White Marker (Off, 1 to 31; default: ***Off***)
- | Erase Color (Off, 1 to 30; default: ***Off***)
- | Echo Colors (***32***, 16, 8)
- | BKGD. Colors (1, ***2***, 3)
- | Bearing (***Relative***, True)
- | Heading (-180 to +179°; default: ***+0°***)
- | Roll Offset (-10.0 to +10.0; default: ***+0.0°***)
- | Pitch Offset (-10.0 to +10.0; default: ***+0.0°***)
- | Sensor Correct (-180 to +179°; default: ***+0°***)

3 HOR.

- | TVG Level-LF (0.0 to 10.0; default: ***4.0***)
- | TVG Level-HF (0.0 to 10.0; default: ***4.0***)
- | TVG Distance-LF (0.0 to 10.0; default: ***4.0***)
- | TVG Distance-HF (0.0 to 10.0; default: ***4.0***)
- | Gain ADJ.-LF (-10 to +10; default: ***0***)
- | Gain ADJ.-HF (-10 to +10; default: ***0***)
- | RES. Color-LF (***LOG***, Linear, Square, Cube)
- | RES. Color-HF (***LOG***, Linear, Square, Cube)
- | Clutter-LF (***0***, 1, 2, 3)
- | Clutter-HF (***0***, 1, 2, 3)
- | Tracking Key (Position, ***Echo***, Reverse)
- | Tracking Mode (***Auto***, Manual)
- | Auto Tilt (***Off***, ±2°, ±4°, ±6°, ±10°)
- | A-Scope (***Off***, On)

4 VERT

- | TVG Level-LF (0.0 to 10.0; default: ***4.0***)
- | TVG Level-HF (0.0 to 10.0; default: ***4.0***)
- | TVG Distance-LF (0.0 to 10.0; default: ***4.0***)
- | TVG Distance-HF (0.0 to 10.0; default: ***4.0***)
- | Gain ADJ.-LF (-10 to +10; default: ***0***)
- | Gain ADJ.-HF (-10 to +10; default: ***0***)
- | RES. Color-LF (***LOG***, Linear, Square, Cube)
- | RES. Color-HF (***LOG***, Linear, Square, Cube)
- | Clutter-LF (***0***, 1, 2, 3)
- | Clutter-HF (***0***, 1, 2, 3)
- | HOR. Range (***×1***, ×2)

(Continued on next page)

(Continued from previous page)

5 ES

- | TVG Level-LF (0.0 to 10.0; default: **4.0**)
- | TVG Level-HF (0.0 to 10.0; default: **4.0**)
- | TVG Distance-LF (0.0 to 10.0; default: **4.0**)
- | TVG Distance-HF (0.0 to 10.0; default: **4.0**)
- | Gain ADJ.-LF (-10 to +10; default: **0**)
- | Gain ADJ.-HF (-10 to +10; default: **0**)
- | RES. Color-LF (**LOG**, Linear, Square, Cube)
- | RES. Color-HF (**LOG**, Linear, Square, Cube)
- | Clutter-LF (**0**, 1, 2, 3)
- | Clutter-HF (**0**, 1, 2, 3)
- | A-Scope (**Off**, On)

6 FUNC Key

- | Key1 (Preset Key)
- | Key2 (**VERT Search**, Delete Mark,)
- | Key3 (VERT Search, **Delete Mark**)

7 System

- | System Setting
 - | System Setting 1
 - | Position Display (**Ship's L/L**, Cursor L/L)
 - | Track (Off, **On**)
 - | Current Data (**Off**, Inbound, Outbound)
 - | Heading Indication (**True**, Azimuth)
 - | Display Range Ring (Off, **On**)
 - | North Mark (**Off**, On)
 - | CSE. Data (**Nav.**, Gyro)
 - | Nav. Data (**GPS**, Other)
 - | NMEA1 Baudrate (**4800**, 9600, 19200, 38400)
 - | NMEA2 Baudrate (**4800**, 9600, 19200, 38400)
 - | TVG Correction (**Off**, 1/2, 1/1)
 - | Units (**m**, ft, fm, HR, pb)
 - | Temp Display (**°C**, °F)
 - | Temp Graph (**Off**, 20min, 60min)
 - | TLL Output (**Off**, On)
 - | System Setting 2
 - | Gain Setting Protect (**Off**, On)
 - | Emphasis Mode (Off, **Normal**, Red)
 - | Stabilizer (Off, **On(Std.)**, On(Gyro))
 - | Auto Retract (Off, 5 to 15; default: **Off**)
 - | Speed Alarm Message (Off, **On**)
 - | Sweep Indicator (Dot, **Line**)
 - | Menu BKGD. Transp. (Off, 1 to 5; default: **5**)
 - | FUNC Key1 (Preset Key, **Short-Cut Key**)
 - | FUNC Key2 (Preset Key, Short-Cut Key)
 - | FUNC Key3 (Preset Key, Short-Cut Key)
 - | Default Settings (**No**, Yes)
 - | System Setting 3
 - | HOR./HISTORY (Off, **On**)
 - | HOR./VERT (Off, **On**)
 - | HOR./VERT ZOOM (Off, **On**)
 - | Full A-Scope (Off, **On**)
 - | HOR./Full A-Scope (Off, **On**)

(Continued on next page)

(Continued from previous page)

- Range Settings
 - HOR. (All defaults shown below)
 - m: 20, 40, 60, 80, 100, 120, 160, 200, 250, 300, 400, 500, 600, 800, 1200
 - ft: 40, 80, 120, 200, 300, 400, 500, 600, 700, 800, 1000, 1500, 2000, 2500, 3500
 - fm: 10, 20, 30, 40, 60, 80, 100, 120, 140, 160, 200, 250, 300, 400, 500
 - HR: 10, 20, 40, 60, 80, 100, 120, 140, 160, 200, 250, 300, 400, 500, 700
 - pb: 10, 20, 40, 60, 80, 100, 120, 140, 160, 200, 250, 300, 400, 500, 700
 - VERT (All defaults shown below)
 - m: 10, 20, 30, 40, 60, 80, 100, 120, 160, 200, 250, 300, 400, 500, 600
 - ft: 30, 60, 90, 120, 150, 200, 250, 300, 400, 500, 600, 800, 1000, 1500, 2000
 - fm: 10, 20, 30, 40, 50, 60, 80, 100, 120, 140, 160, 200, 250, 300, 400
 - HR: 10, 20, 30, 40, 50, 60, 80, 100, 120, 140, 160, 200, 250, 300, 400
 - pb: 10, 20, 30, 40, 50, 60, 80, 100, 120, 140, 160, 200, 250, 300, 400
 - ES (All defaults shown below)
 - m: 10, 20, 30, 40, 60, 80, 100, 120, 160, 200, 250, 300, 400, 500, 600
 - ft: 30, 60, 90, 120, 150, 200, 250, 300, 400, 500, 600, 800, 1000, 1500, 2000
 - fm: 10, 20, 30, 40, 50, 60, 80, 100, 120, 140, 160, 200, 250, 300, 400
 - HR: 10, 20, 30, 40, 50, 60, 80, 100, 120, 140, 160, 200, 250, 300, 400
 - pb: 10, 20, 30, 40, 50, 60, 80, 100, 120, 140, 160, 200, 250, 300, 400
- Train Speed Setting
 - 6° (Off, **On**)
 - 12° (Off, **On**)
 - 15° (Off, **On**)
 - 18° (Off, **On**)
 - 21° (Off, **On**)
 - 24° (Off, **On**)
- Color Settings (Opens Color Palette)
- Language Settings (Japanese, **English**, Thai, Vietnamese, Chinese, Spanish, Indonesian, Malay, Burmese, French, Norwegian, Italian, Greek)
- System Backup (**No**, Internal)
- Load Backup Data (**No**, Load Internal Data)
- Preset Backup (**No**, Internal)
- Load Preset Data (**No**, Load Internal Data)
- Draught Offset
 - Draught (-5.0 m to 60.0 m; default: **0.0 m**)
 - Hull Unit Stroke (0 mm to 400 mm; default **400 mm**)
- TX Frequency Offset
 - FREQ. Shift (Range and default dependent on transducer)
- Audio
 - Audio FREQ. (0.90 kHz to 1.20 kHz; default: **1.00 kHz**)
 - Bandwidth (Wide, **Std.**, Narrow)
 - Harmonic Pattern (**1**, 2, 3)
 - Auto Filter (**Off**, On)
 - Audio Priority (**High FREQ**, Low FREQ)
- Tests (Starts diagnostic test)
- Test Pattern (Starts LCD test)
- NMEA Port Monitor (Starts port monitor)
- Simulation
 - Simulation Mode (**No**, Load Internal Data)
- Restore Initial Settings (**No**, Yes)

**SPECIFICATIONS OF
SEARCHLIGHT SONAR CH-500
DUAL-FREQUENCY SEARCHLIGHT SONAR CH-600**

1 TRANSCIVER UNIT

| | | |
|-----|--------------|---|
| 1.1 | Frequency | |
| | CH-500 | 60/88/150/180/240 kHz (selected) |
| | CH-600 | 60/153 kHz or 85/215 kHz (dual frequency) |
| 1.2 | Output power | |
| | CH-500 | 0.8 kW to 1.5 kW (depending on frequency), power reduction function available |
| | CH-600 | 1 kW |
| 1.3 | Pulse length | 0.2 to 20.0 ms, according to range (up to 10 ms for each frequency in dual-frequency transmission) |
| 1.4 | TVG | Level: 100 dB max, Distance: 1000 m max. |
| 1.5 | Range | |
| | Horizontal | 10 to 2400 m, 15 steps (user selectable) |
| | Vertical | 10 to 600 m, 15 steps (user selectable) |
| 1.6 | Audio output | 2 W (8 ohms), Freq. 0.9 to 1.2 kHz (optional speaker required) |

2 DISPLAY UNIT

| | | |
|------|--------------------|---|
| 2.1 | Screen type | 12.1 inch color LCD, XGA (1024 x 768) |
| 2.2 | Brilliance | 0.5 to 950 cd/m ² (selectable) |
| 2.3 | Echo color | 32, 16 or 8 colors (selectable) |
| 2.4 | Back-ground color | 3 colors (selectable) |
| 2.5 | Display mode | |
| | CH-500/600 | Horizontal (Normal/Zoomed/Vertical or History combined/ Split horizontal + Vertical/A-Scope combined), Vertical scan, Echo sounder (Normal/A-Scope combined), Full-circle A-Scope (Normal/Horizontal dual) |
| | CH-600 only | Dual horizontal (Normal/Zoomed)/ Vertical/ Echo sounder; High, low or mixed frequency mode selected from control unit |
| 2.6 | Echo information | Range, Sensitivity, TVG, Tilt angle, Interference rejection |
| 2.7 | Sensor information | L/L (own ship or cursor), Depth, Bearing, Ship's speed, Track, Water current vector, Water temperature (external data required) |
| 2.8 | Marker | Range and bearing to target |
| 2.9 | Indication unit | Meter, feet, fathom, pb, HIRO |
| 2.10 | Event mark | 5 points |
| 2.11 | Echo adjustment | Erase color, Clutter, Emphasis mode, Quick gain setting, Auto-filter, Reverberation suppression |
| 2.12 | Others | Interference rejection, Menu background transparency, Target lock (three functions selected on menu) |

3 HULL UNIT

| | | |
|-----|------------------------|--|
| 3.1 | Transducer travel | 400 mm (CH-5041) or 250 mm (CH-5051) |
| 3.2 | Tank size (inner dia.) | 8-inch (CH-5048), 6-inch (CH-5046, CH-500: 180 kHz only) |
| 3.3 | Raise/lower time | 30 s at 400 mm travel, 20 s at 250 mm travel |
| 3.4 | Ship's bow setting | Setting offset on menu at installation |

3.5 Full circle scanning period (s)

| No. | 1 | 2 | 3 | 4 | 5 | 6 | 7 | 8 | 9 | 10 | 11 | 12 | 13 | 14 | 15 | |
|------------|-----|-----|-----|-----|-----|-----|------|------|------|------|------|------|------|------|------|------|
| Range (m) | 10 | 20 | 40 | 60 | 80 | 120 | 160 | 200 | 250 | 300 | 400 | 500 | 600 | 800 | 1000 | |
| Step angle | 6° | 3.8 | 3.8 | 3.8 | 5.2 | 6.8 | 10.1 | 12.9 | 16.5 | 20.6 | 24.3 | 32.5 | 40.5 | 48.3 | 64.6 | 80.5 |
| | 15° | 3.7 | 3.7 | 3.7 | 3.8 | 4.8 | 5.6 | 7.2 | 8.4 | 10.1 | 12.0 | 15.0 | 18.2 | 21.6 | 27.8 | 34.1 |
| | 24° | 3.7 | 3.7 | 3.7 | 3.7 | 3.9 | 4.5 | 5.8 | 6.6 | 7.7 | 8.8 | 10.7 | 12.8 | 15.0 | 18.7 | 22.6 |

3.6 Horizontal mode control

Scanning angle 6° to 360°, 24° step
 Scanning speed (step-angle) 6°, 12°, 15°, 18°, 21°, 24°
 Tilt angle -5° to +90°(vertical), 1° step
 Auto tilt setting ±2° to ±10°

3.7 Vertical fan mode control

Scanning angle 6° to 180°, 12° step
 Scanning speed (step-angle) Normal: 3°, High speed: 6°

3.8 Transceiver beam width

| | | | |
|----------|-----------|------------------------|----------------------|
| CH-500 | Frequency | Horizontal (-3dB/-6dB) | Vertical (-3dB/-6dB) |
| | 60 kHz: | 15°/20° | 12°/17° |
| | 88 kHz: | 12°/16° | 10°/13° |
| | 150 kHz: | 7°/9° | 7°/9° |
| | 180 kHz: | 7°/9° | 8°/10° |
| 240 kHz: | 6°/8° | 6°/8° | |
| CH-600 | Frequency | Horizontal (-3dB/-6dB) | Vertical (-3dB/-6dB) |
| | 60 kHz: | 16°/22° | 14°/20° |
| | 153 kHz: | 7°/9° | 5°/8° |
| | 85 kHz: | 11°/15° | 10°/14° |
| | 215 kHz: | 5°/6° | 4°/6° |

3.9 Allowable ship's speed 20 kn or less (15 kn during raise/lower operation)

3.10 Stabilization Built-in motion sensor (standard supply)

4 INTERFACE

4.1 Number of ports

Video signal output 1 port, HDMI, XGA
 NMEA0183 (IEC61162-1) 2 ports, V1.5/2.0/3.0/4.0/4.1, 4800/9600/19200/38400 bps
 NMEA2000 1 port
 External KP 1 port, I/O

4.2 Data sentences

Input CUR, DBS, DBT, DPT, GGA, GLL, GNS, HDG, HDM, HDT, MDA, MTW, RMC, VHW, VTG, ZDA
 Output TLL

4.3 Output proprietary sentence

PFEC pidat

4.4 NMEA2000 PGN

Input 059392/904, 060160/416/928, 061184, 065240, 126208/720/992/996, 127250, 128259/267, 129025/026/029/033/291, 130310/311/312/316/577/821
 Output 059392/904, 060928, 061184, 126208/464/720, 126993/996/998, 130822/823/828

5 POWER SUPPLY

- 5.1 Display/ Control/ Transceiver unit 12-24 VDC: 4.7-2.3 A
- 5.2 Hull unit 12/24 VDC: 2.2/1.1 A (7.2/3.6 A: During raising)
- 5.3 Rectifier (option)
RU-1746B-2 100/110/115/220/230 VAC, 1 phase, 50/60 Hz, 13 A max.
- 5.4 AC/DC power supply unit (option)
PR-241 100-230 VAC, 1 phase, 50-60 Hz

6 ENVIRONMENTAL CONDITION

- 6.1 Ambient temperature
 - Display/ Transceiver/ Control unit -15°C to +55°C
 - Hull unit 0°C to +55°C (Transducer: 0 to +35°C)
- 6.2 Relative humidity 95% or less at +40°C
- 6.3 Degree of protection
 - Display/ Control unit IP55
 - Transceiver/ Hull unit IP22 (Raise/lower control unit: IP55)
- 6.4 Vibration IEC60945 Ed.4

7 UNIT COLOR

- 7.1 Display/ Control/ Transceiver unit N2.5

This page is intentionally left blank.

INDEX

- A**
- A-Scope mode 2-6
- B**
- Backup/restore settings..... 5-9
- Brilliance
 - how to adjust the brilliance 1-5
- C**
- Cleaning the equipment 6-1
- Controls 1-1
 - CH-502 description 1-1
 - CH-506 description 1-2
- Cursor
 - how to use the cursor 1-13
- D**
- Diagnostics..... 6-7
 - LCD test 6-8
 - system test 6-7
- Display modes
 - how to select 1-6
- E**
- Echo sounder mode 4-1
 - adjusting the picture 4-4
 - a-scope dual display 4-6
 - display example 4-1
 - menu overview 4-2
 - selecting a picture advance speed 4-3
- Error messages 6-6
- Event mark 1-22
 - how to delete marks 1-23
 - how to inscribe a mark 1-22
- F**
- Function keys 5-5
 - preset keys 5-6
 - setting up function keys 5-5
 - shortcut keys 5-5
- G**
- Gain..... 1-8
- H**
- Horizontal mode 2-1
 - adjusting the picture 2-16
 - bottom tail suppression 2-16
 - displaying weak echoes clearly 2-17
 - horizontal+cross section dual display..... 2-8
 - horizontal+vertical dual display 2-9
 - how to interpret the display 2-12
 - menu overview 2-2
 - operational overview 2-1
 - seabed/surface reflection suppression.. 2-16
 - TVG 2-17
 - zoomed example 2-7
- Horizontal mode
 - display example..... 2-5
- Hull unit maintenance..... 6-2
 - lubrication 6-2
 - raising/lowering manually 6-3
- M**
- Maintenance
 - cleaning 6-1
 - fuses 6-4
 - hull unit 6-2
 - transducer 6-4
- Maintenance/Troubleshooting 6-1
- Menu operations 5-1
 - accessing the menus 5-1
 - changing the language 5-2
 - COM1 menu 5-2
 - COM2 menu 5-3
 - FUNC Key menu 5-5
- N**
- Noise/interference 1-10
 - erase weak echoes 1-13
 - false echo 1-11
 - marine life 1-12
 - other interference 1-12
 - reflections 1-10
 - sidelobe echo 1-11
 - wake 1-10
- P**
- Power 1-2
- Power key 1-2
- Preventative maintenance..... 6-1
- R**
- Range
 - how to adjust the range 1-14
- Range mark..... 1-23
- S**
- Sectors 1-19
 - horizontal sector 1-19
 - sector center - vertical 1-21
 - vertical sector 1-20
- Simulation mode 5-13
- Speaker
 - adjusting speaker bandwidth..... 5-11
 - adjusting speaker frequency 5-11
 - adjusting speaker harmonic pattern 5-12
 - filtering for doppler shift 5-12
- System menu 5-4
 - adjusting speaker settings..... 5-11
 - adjusting TX frequency..... 5-10
 - backup/restore settings 5-9
 - changing the color scheme 5-8
 - changing the displayed colors 5-8
 - range presets 5-7

INDEX

| | |
|--|-----------|
| restoring default settings | 5-14 |
| train speed presets..... | 5-8 |
| System Setting menu | 5-15 |
| T | |
| Tilt control | 1-18 |
| echo sounder mode | 1-18, 4-3 |
| horizontal modes..... | 1-18 |
| TILT knob..... | 1-18 |
| Tracking | |
| echo tracking..... | 1-26 |
| how to use tracking | 1-25 |
| position tracking | 1-25 |
| selecting a tracking mode | 1-25 |
| Train | 1-16 |
| control for echo sounder | 1-17 |
| control for horizontal..... | 1-16 |
| control for vertical..... | 1-17 |
| how to change direction | 1-16 |
| Transducer..... | 1-3 |
| how to lower | 1-3 |
| how to raise..... | 1-5 |
| Transducer maintenance | 6-4 |
| Troubleshooting | 6-5 |
| TVG | |
| how to adjust TVG for echo sounder mode..... | 4-4 |
| how to adjust TVG in horizontal mode | 2-17 |
| V | |
| Vertical mode | 3-1 |
| adjusting the picture | 3-4 |
| display example | 3-1 |
| interpreting the display | 3-3 |
| menu overview | 3-2 |
| selecting a train speed | 3-4 |



Declaration of Conformity



We **FURUNO ELECTRIC CO., LTD.**

(Manufacturer)

9-52 Ashihara-Cho, Nishinomiya City, 662-8580, Hyogo, Japan

(Address)

declare under our sole responsibility that the product

SEARCHLIGHT SONAR CH-500
DUAL-FREQUENCY SEARCHLIGHT SONAR CH-600

(Model name, type number)

to which this declaration relates conforms to the following standard(s) or other normative document(s)

EU
EMC Directive 2014/30/EU

IEC 60945 Ed.4.0: 2002

For assessment, see

- Test report
Labotech International Co., Ltd.
LIC 12-16-111 Rev.1, 7 Apr 2017
LIC 12-16-139 Rev.1, 7 Apr 2017

UK
SI 2016 No.1091 EMC Regulations 2016 as amended

EN 60945: 2002

For assessment, see

- Test report
Labotech International Co., Ltd.
LIC 12-16-111 Rev.1, 7 Apr 2017
LIC 12-16-139 Rev.1, 7 Apr 2017

(title and/or number and date of issue of the standard(s) or other normative document(s))

On behalf of Furuno Electric Co., Ltd.

Nishinomiya City, Japan
26 July 2021

(Place and date of issue)

Akihiko Kanechika
Department General Manager
Quality Assurance Department

(name and signature or equivalent marking of authorized person)