

# **FURUNO**

## **OPERATOR'S MANUAL**

*VOYAGE DATA RECORDER (VDR)  
SIMPLIFIED VOYAGE DATA  
RECORDER (S-VDR)*

Model **VR-7000/VR-7000S**

---



# IMPORTANT NOTICES

---

## General

- This manual has been authored with simplified grammar, to meet the needs of international users.
- The operator of this equipment must read and follow the instructions in this manual. Wrong operation or maintenance can void the warranty or cause injury.
- Do not copy any part of this manual without written permission from FURUNO.
- If this manual is lost or worn, contact your dealer about replacement.
- The contents of this manual and the equipment specifications can change without notice.
- The example screens (or illustrations) shown in this manual can be different from the screens you see on your display. The screens you see depend on your system configuration and equipment settings.
- Save this manual for future reference.
- Any modification of the equipment (including software) by persons not authorized by FURUNO will void the warranty.
- The following concern acts as our importer in Europe, as defined in DECISION No 768/2008/EC.
  - Name: FURUNO EUROPE B.V.
  - Address: Ridderhaven 19B, 2984 BT Ridderkerk, The Netherlands
- All brand, product names, trademarks, registered trademarks, and service marks belong to their respective holders.

## How to discard this product

Discard this product according to local regulations for the disposal of industrial waste. For disposal in the USA, see the homepage of the Electronics Industries Alliance (<http://www.eiae.org/>) for the correct method of disposal.

## How to discard a used battery

Some FURUNO products have a battery(ies). To see if your product has a battery, see the chapter on Maintenance. If a battery is used, tape the + and - terminals of the battery before disposal to prevent fire, heat generation caused by short circuit.

### In the European Union

The crossed-out trash can symbol indicates that all types of batteries must not be discarded in standard trash, or at a trash site. Take the used batteries to a battery collection site according to your national legislation and the Batteries Directive 2006/66/EU.



### In the USA

The Mobius loop symbol (three chasing arrows) indicates that Ni-Cd and lead-acid rechargeable batteries must be recycled. Take the used batteries to a battery collection site according to local laws.

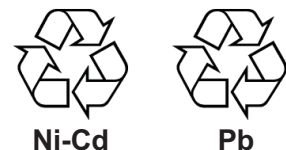

### In the other countries

There are no international standards for the battery recycle symbol. The number of symbols can increase when the other countries make their own recycle symbols in the future.



# SAFETY INSTRUCTIONS



## WARNING

Indicates a condition that can cause death or serious injury if not avoided.



## CAUTION

Indicates a condition that can cause minor or moderate injury if not avoided.



Warning, Caution



Prohibitive Action



Mandatory Action



## WARNING



**ELECTRICAL SHOCK HAZARD**  
**Do not open the equipment.**

Only qualified personnel should work inside the equipment.



**Do not disassemble or modify the equipment.**

Fire, electrical shock or serious injury can result.



**Immediately turn off the power (BATTERY and AC switches in that order) at the DCU and also turn off the power at the ship's mains switchboard if water leaks into the equipment or the equipment is emitting smoke or fire.**

Continued use can cause fatal damage to the equipment.



**Do not disassemble the DRU.**

The important data is saved to the DRU. To prevent the loss of data, do not disassemble the DRU.



**Do not allow rain or water splash to contact the equipment.**

Fire or electrical shock can result.



## WARNING



**Do not disassemble the battery in the DCU.**

Battery fluid is harmful to the eyes and skin, particularly the eyes. If the fluid contacts skin or eyes, flush area with fresh water and contact a physician immediately.



**Do not short battery terminals.**

Short can lead to bursting or fire.



**Do not dispose of the battery or acoustic beacon of the Fixed DRU in fire.**

Those components may burst if disposed of in fire. Further, dispose of the battery in accordance with appropriate regulations.



**Do not touch any electrically conductive parts.**

Touching electrically conductive parts can result in electrical shock. Use rubber gloves, etc. when conducting inspection or maintenance work.



**Use the correct fuse.**

A wrong fuse can cause fire or serious damage to the equipment.

 **WARNING**

 **Do not wet the capsule of the Float-free DRU.**

The wetted capsule may accidentally transmit a signal.

---

 **Do not approach the antenna of the Float-free DRU.**

The antenna of the Float-free DRU emits electromagnetic radio frequency (RF) that can be harmful to the human body. Distance at which RF radiation level of 100 and 10 W/m<sup>2</sup> are given in the table below.

RF power density	Distance	Description required by
100W/m <sup>2</sup>	0.16m	IEC60945
10W/m <sup>2</sup>	0.48m	IEC60945

 **CAUTION**

 **Do not:**

- use batteries of different capacities
- mix old batteries with new
- mix batteries of different makes

The battery of the DCU and Float-free DRU have multiple cells. Batteries themselves may become damaged or damage to electrical parts may result.

---

 **Do not connect/disconnect the cable while turning the power on.**

The unit may be damaged.

### About the TFT LCD

The TFT LCD is constructed using the latest LCD techniques, and displays 99.99% of its pixels. The remaining 0.01% of the pixels may drop out or blink, however this is not an indication of malfunction.

### WARNING LABELS

Warning labels are attached to the DCU.

Do not remove the labels. If the label is missing or damaged, contact a FURUNO agent or dealer about replacement.

 <b>WARNING</b> 
To avoid electrical shock, do not remove cover. No user-serviceable parts inside.
 <b>警告</b> 
感電の恐れあり。 サービスマン以外の方はカバーを開けないで下さい。内部には高電圧部分が多い数多くあり、万一さわると危険です。

Name: Warning Label 1  
 Type: 86-003-1011-3  
 Code No.: 100-236-233-10

# TABLE OF CONTENTS

---

<b>FOREWORD</b> .....	<b>v</b>
<b>SYSTEM CONFIGURATION</b> .....	<b>vii</b>
<b>1. OPERATION</b> .....	<b>1</b>
1.1 Overview .....	1
1.2 Operating Procedure.....	5
1.2.1 How to turn the power on then record the data .....	5
1.2.2 How to stop recording.....	6
1.3 Operation on Remote Alarm Panel .....	6
1.3.1 Start screen and base screen.....	6
1.3.2 Controls .....	7
1.3.3 How to adjust the brilliance of the LCD and keys .....	7
1.3.4 Alert list.....	8
1.3.5 Main menu overview.....	8
1.3.6 How to extract the recorded data to an external media .....	12
1.3.7 How to record the data to a USB flash memory .....	15
1.3.8 How to execute SAVE function for recorded data (only for VR-7000S).....	16
1.3.9 Brilliance sharing function.....	16
1.4 How to Release the Fixed DRU .....	17
1.5 How to Release the Capsule from the Bracket of the Float-free DRU in Emergency Situation .....	17
<b>2. MAINTENANCE</b> .....	<b>20</b>
2.1 General Maintenance and Cleaning.....	20
2.2 Maintenance of the Float-free DRU .....	21
2.2.1 Monthly maintenance and self test .....	21
2.2.2 Annual Performance Test for the Float-free DRU.....	26
2.2.3 Shore-Based Maintenance (SBM).....	27
2.3 Annual Recertification .....	27
2.4 Fuse Replacement.....	28
2.5 Consumable Parts.....	28
2.6 Self Test.....	29
2.7 Verification of Recording Function of the Long Term Device.....	31
<b>3. TROUBLESHOOTING</b> .....	<b>32</b>
3.1 General Troubleshooting.....	32
3.2 Alert Numbers .....	32
<b>4. REMOTE PLAYBACK FUNCTION (LAND-SHIP COMMUNICATION)</b> .....	<b>38</b>
4.1 Preparations.....	38
4.2 Limitations and Notifications .....	38
4.3 Recommended Network Construction .....	39
<b>MENU ITEMS</b> .....	<b>AP-1</b>
<b>PARTS LIST/LOCATION</b> .....	<b>AP-2</b>
<b>LIST OF TERMS AND ABBREVIATIONS/SYMBOLS</b> .....	<b>AP-5</b>
<b>PLAYING BACK RECORDED DATA</b> .....	<b>AP-6</b>
<b>SPECIFICATIONS</b> .....	<b>SP-1</b>

# FOREWORD

---

## **A Word to the Owner of the VR-7000/7000S**

Congratulations on your choice of the FURUNO Voyage Data Recorder (VDR) VR-7000/Simplified Voyage Data Recorder (S-VDR) VR-7000S. We are confident you will see why the FURUNO name has become synonymous with quality and reliability.

Since 1948, FURUNO Electric Company has enjoyed an enviable reputation for innovative and dependable marine electronics equipment. This dedication to excellence is furthered by our extensive global network of agents and dealers.

Your equipment is designed and constructed to meet the rigorous demands of the marine environment. However, no machine can perform its intended function unless properly installed and maintained. Please carefully read and follow the operation and maintenance procedures set forth in this manual.

We would appreciate feedback from you, the end-user, about where we are achieving our purposes.

Thank you for considering and purchasing FURUNO equipment.

## **What is a VDR?**

A VDR records various data and events encountered aboard ship. The purpose of the VDR is to help investigators locate the causes of marine incidents.

The revised SOLAS Chapter V requires the installation of VDRs on passenger ships of 150 GT and above on all voyages and other ships of 3000 GT and above on international voyages and for newly built ships on and after 1 July, 2002.

The basic VR-7000/7000S consists of a Data Collecting Unit (DCU), a Data Recording Unit (DRU), a Remote Alarm Panel (RAP), a video LAN converter, a sensor adapter and microphones to record bridge audio. A Junction Box (JB) is optional. The DCU contains the Data Processor Unit, interface modules and backup batteries. It collects data from sensors as required by the IMO and IEC standards. The DCU processes the incoming data and information in the order of occurrence while old data is overwritten with new data for storage in the DRU for 48 hours. The batteries supply power to the DCU to record bridge audio for two hours in case of a ship's mains power failure.

The flash memory in the DRU stores the data coming from the DCU. All essential navigation and status data including bridge conversation, VHF communications, and radar images are recorded. The data can be retrieved by using playback software for investigation after an incident.

The Fixed DRU\* components are embodied in a protective capsule. The capsule ensures survival and recovery of the recorded data after an incident. An acoustical pinger helps locate the Fixed DRU underwater.

The capsule of the Float-free DRU\* is stored in the bracket. When the Float-free DRU sinks to depths of up to four meters, the capsule automatically comes off from the bracket then floats on the sea surface. At the same time, the capsule starts to transmit 406 MHz signal for locating the position of capsule and 121.5 MHz signal for homing for at least 168 hours.

\*: Select one for VR-7000S.

## Features

The main features of the VR-7000/7000S are as shown below.

- Color LCD with remote alarm panel.
- Meets IEC 61996-1 Ed.2, IEC 61996-2 Ed.2, IEC 61162-1 Ed.5, IEC 61162-2 Ed.1, IEC 61162-450 Ed.1 AMD1, IEC 60945 Ed.4.
- Reliable and fast data exchange between DCU and DRU via Ethernet.
- Fixed DRU and Float-free DRU with 48 hours recording.
- Compatible with remote maintenance.
- Recorded data can be analyzed and monitored on shore.
- Software updating from a PC connected to Ethernet.
- Long term device for storage (VR-7000: 720 hours recording, VR-7000S: 48 hours recording) and retrieval of data.

## Program No.

VR-7010 DCU: 2450102-01.XX

VR-7017 RAP: 2450103-01.XX

XX: Minor change (For VR-7000S, XX is 10 or after for DCU, 06 or after for RAP.)

**Note:** When the VDR program version is “01.20” or later, Live Player V5 program version should be “01.10” or later. When the VDR program version is “01.20” or earlier, Live Player V5 program version should be “01.20” or earlier.

## Fonts

The “iwata open type” font is used for the Remote Alarm Panel VR-7017.

## Open Source Software

This product includes software to be licensed under the GNU General Public License (GPL), GNU Lesser General Public License (LGPL), BSD, Apache, MIT and others. The program(s) is/are free software(s), and you can copy it and/or redistribute it and/or modify it under the terms of the GPL or LGPL as published by the Free Software Foundation. Please access to the following URL if you need source codes: [https://www.furuno.co.jp/cgi/cnt\\_oss\\_e01.cgi](https://www.furuno.co.jp/cgi/cnt_oss_e01.cgi)

## Reverse engineering

Reverse engineering (reverse assemble, reverse compiler) of the software of this equipment is strictly prohibited.

However, reverse engineering is permitted under the following conditions:

- The library used for the reverse engineering (GNU Library General Public License Version 2, GNU Lesser General Public License Version 2.1, or later editions) is clearly noted.
- The reverse engineered software is used only within the scope outlined under the appropriate license.



# SYSTEM CONFIGURATION

Basic configuration is shown with solid line.

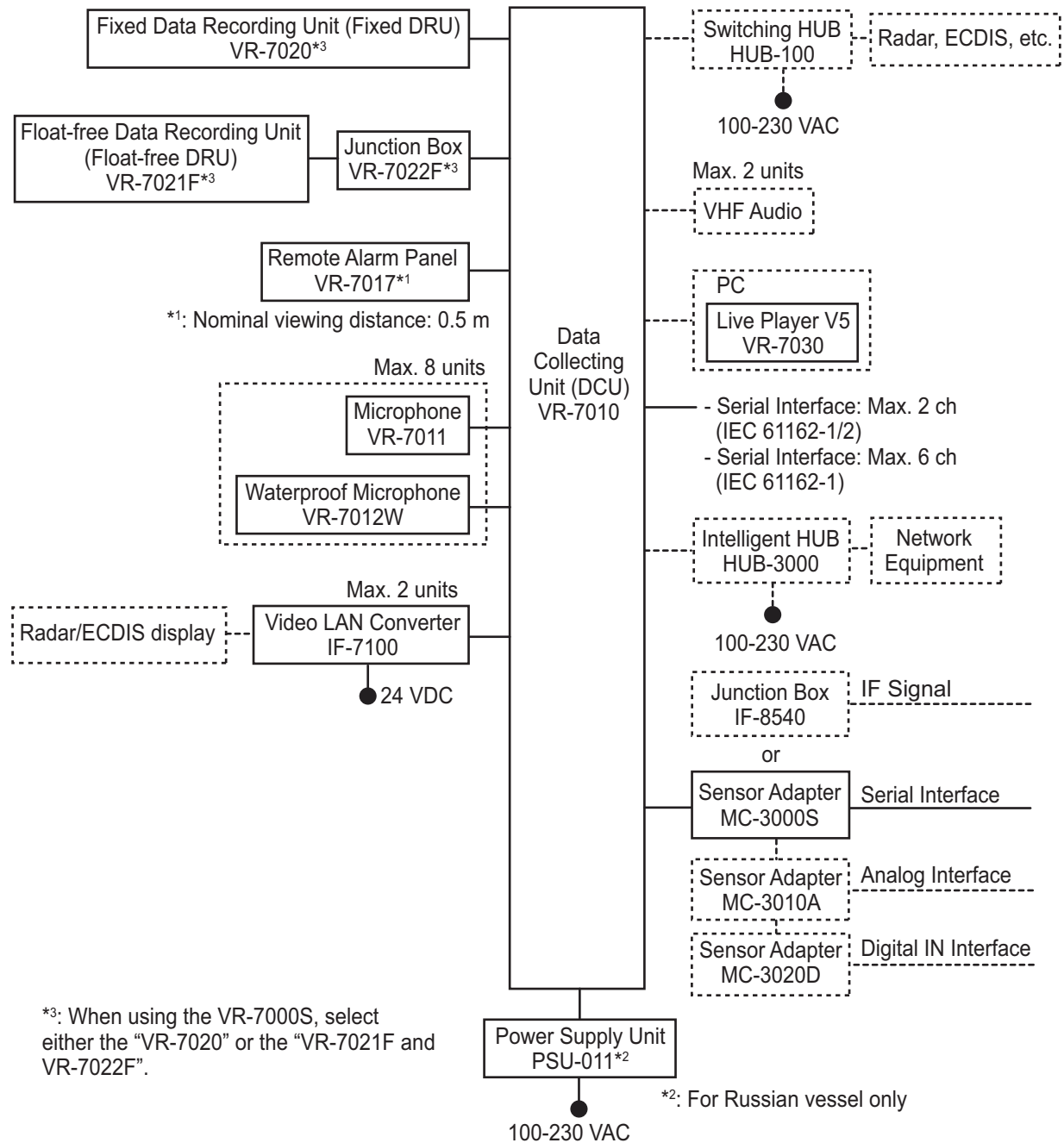

## Environmental category

All units (other than VR-7021F, VR-7022F, VR-7012W and VR-7020)	Protected from the weather
VR-7021F	Portable
VR-7022F, VR-7012W, VR-7020	Exposed to the weather

# 1. OPERATION

---

## 1.1 Overview

The VR-7000/7000S consists of a Data Collecting Unit (DCU), Data Recording Units (Fixed DRU and Float-free DRU), Remote Alarm Panel (RAP), Video LAN Converter, Sensor Adapter and bridge microphone units. The VDR system continuously stores data for 48 hours onto the Flash Memory in the capsule, erasing the oldest data stored as new data is recorded. The VDR mainly records the sentences shown in the table below.

*Main sentences to be recorded*

Data to be recorded	IEC 61162 formatter
Date and time	ZDA
Ship's position and datum used	GNS and DTM
Speed (water and/or ground)	VBW
Heading (true)	HDT
Heading (magnetic)	HDG
AIS-VHF data-link message	VDM
AIS-VHF data-link own-vessel message	VDO
Depth (echo sounder)	DPT
Alerts and Alarms	ACN, ALC, ALF, ALR
Rudder sensor angle	RSA
Rudder order status	ROR
Heading/track control command	HTC
Heading/track control data	HTD
Engine order/response	RPM, XDR
Hull openings, watertight doors	XDR
Accelerations and hull stress	HSS, XDR
Wind speed and direction	MWV
VDR alert output	ALF, ALC
Heartbeat supervision sentence	HBT

### **Power supply precaution**

If ship's mains power source (100-230 VAC) and emergency source fail, the VR-7000/7000S continues to record bridge audio for two hours from backup batteries.

### **Continuity of storing data**

The VDR should be provided with power to store data for over 48 hours (for Fixed DRU and Float-free DRU) or over 720 hours (for long term device of the DCU) on a first-in, first-out basis. Recording is terminated only under the following conditions:

- During essential maintenance while the vessel is in port.
- When the vessel is laid-up.

### **Data Collecting Unit**

The DCU mainly consists of a Data Processor Unit and Power Control Panel. The DCU includes batteries with a lifetime of approximately four years. The DCU collects the data from various sen-

sors radar/ECDIS and records them in the Fixed DRU, Float-free DRU and internal long term device.

Recording interval of data and audio is as follows:

- Radar/ECDIS video signal: every 15 seconds
- Bridge and VHF audio: real time
- IEC sentences: when received
- Analog and digital data: every second

For VR-7000, you can select one or two 512-GB SSD(s) as internal long term device(s). When selecting one SSD, you can add another one using an optional SSD kit later.

No. of pcs	Storage time	Video signal channels recorded at the same time
1 SSD (512 GB)	720 hours	Up to 5 channels*
2 SSDs (1 TB)		Up to 6 channels*

\*: The recording interval for 3 channels is 15 seconds, which is compliant with IEC61996-1 Ed.2 and IEC61996-2 Ed.2. Other channels record a maximum of four video signals at intervals of 15 seconds, using the time-division method.

For VR-7000S, there are four save areas (Area1, 2, 3, 4) in the long term device(s). Each area can record data for 12 hours.

### **Data Recording Unit**

#### **Fixed DRU**

The Fixed DRU is housed in a highly visible protective capsule which can withstand a fire of 1,100°C for one hour and deep-sea pressure of 6,000 m.

The underwater acoustic beacon (pinger) on the capsule automatically transmits 10 ms pulses at 37.5 kHz for at least 90 days when it is submerged in water. The expected life of the beacon battery is three years.

#### **Float-free DRU**

The capsule of the Float-free DRU has the same functionality of an satellite EPIRB (Emergency Position-Indicating Radio Beacon). The VDR data is recorded in the storage module at the bottom of capsule.

The DCU feeds the VDR data to the bracket of the Float-free DRU through the LAN cable, then the bracket feeds the data to the capsule by wireless communication.

The capsule of the Float-free DRU is stored in the bracket. When the Float-free DRU sinks to depths of up to four meters, the capsule is automatically released from the bracket then floats to the sea surface. At the same time, the capsule starts to transmit 406 MHz signal for locating the position of capsule and 121.5 MHz signal for homing for at least 168 hours.

**Note:** Select fixed DRU or float-free DRU for VR-7000S.

### **Data items to be recorded**

**Note:** If the sensor data is input to the DCU through an external unit (sensor adapter, junction box, etc.), the input of the sensor data is delayed because of the communication lag between the DCU and external unit.

## 1. OPERATION

**Date and time:** Date and time are obtained from an external GPS navigator referenced to UTC. When an external GPS navigator is not available, a signal is recorded with a built-in clock in the DCU.

**Ship's position and datum used:** Latitude, longitude and datum are obtained from a GPS navigator, Loran-C receiver or other EPFS or INS available on standard serial interface. The source of data is identifiable on playback.

**Speed (water and/or ground):** Speed through the water (STW) or speed over the ground (SOG) is recorded. The resolution is 0.1 kn. Transverse speed is also indicated when available on board.

**Heading (true, magnetic):** Heading is recorded to a resolution of 0.1°. The data is labeled G (gyrocompass), GPS, GLONASS, MAG. If heading information is not available in IEC 61162 format, an appropriate interface may be necessary.

**Depth (echo sounder):** Depth under keel up to a resolution of 0.1 m as available on the ship is recorded.

**Alarms:** The status of all IMO mandatory alarms is recorded individually with ID number and time stamp. Audible alarms from the alarm units are stored simultaneously by the bridge audio microphones.

**Rudder order/response:** Rudder order and response angles are recorded up to a resolution of 1° as available on the ship. The rudder information is recorded. If more than one rudder is provided, the circuitry can be duplicated.

**Engine order/response:** The DCU obtains the engine order and response from the engine telegraph or direct engine control. The engine parameters with shaft revolution and ahead/astern indicators are recorded to a resolution of 1 rpm.

All order and response from bow, stern, thruster, tunnel thrusters and controllable pitch propellers shall be recorded.

**Hull openings, watertight doors:** Digital and serial signals can be input individually. The data is stored with time stamps.

**Accelerations and hull stresses:** The DCU obtains signals from appropriate hull stress and response monitoring devices. The inputs are recorded individually and stored with time stamps.

**Wind speed and direction:** The DCU obtains the signal from appropriate wind speed and direction sensor. The inputs are recorded individually and stored with time stamps. The wind speed resolution is 1 unit (1 kn, 1 m/s, etc.). The wind direction resolution is 1°.

**VDR alarm output:** If, as an option, such messages are sent then the appropriate sentence formats are ALF and ALC.

**Radar/ECDIS data:** Radar/ECDIS image is recorded in the Fixed DRU, Float-free DRU and long term device via the LAN or the video LAN converter. Range rings, EBLs, VRMs, plotting symbols, radar maps, parts of SENC, voyage plan, and other essential navigational indications are included in the recorded radar image. Own ship's mark and position (latitude and longitude), course, speed, voyage plan, and other essential navigational indications are included in the recorded ECDIS image. One complete picture frame is captured at intervals of 15 s. Scanning may be interlaced or non-interlaced.

The channel number and resolution can be recorded is shown in the table below.

Input method	No. of pcs	Resolution/Max. channel number
Inputs through the video LAN converter	1 SSD (512 GB)	UXGA (1600×1200): 2 ch + Full HD (1920×1080): 1 ch
	2 SSDs (1 TB)	UXGA (1600×1200): 2 ch + Full HD (1920×1080): 1 ch + WUXGA (1920×1200): 1 ch*
IEC61162-450 format	1 SSD (512GB)	For PNG format: UXGA (1600×1200): 2 ch + Full HD (1920×1080): 1 ch For JPEG format (quality is 50 or above): WUXGA (1920×1200): 3 ch For JPEG format (quality is less than 50): WUXGA (1920×1200): 5 ch
	2 SSDs (1TB)	For PNG format: UXGA (1600×1200): 2 ch + Full HD (1920×1080): 1 ch + WUXGA (1920×1200): 1 ch* For JPEG format (quality is 50 or above): WUXGA (1920×1200): 3 ch + WUXGA (1920×1200): 1 ch* For JPEG format (quality is less than 50): WUXGA (1920×1200): 5 ch + WUXGA (1920×1200): 1 ch*

\*: Recorded to the long term device (SSD) only. Not recorded to the Fixed DRU and Float-free DRU.

**Bridge audio:** Up to eight microphones are supplied as standard to record conversation at conning station, radar display and chart table. Microphone captures conversation in the bridge, audio signals from equipment and sound from machinery. The microphone generates a test beep every 12 hours which is also recorded. The microphone picks up audio signals ranging from 150 to 6000 Hz.

**Communications audio:** A maximum of two VHF communications are recorded for both transmitted and received audio signals.

#### **Minimum data retention period**

The VDR data is retained in the recording media, following termination of recording. The minimum data retention periods for each recording unit are shown in the table below (IEC61996-1 compliant).

Unit	Minimum Data Retention Period
Long term device (DCU)	2 years after recording
Fixed DRU	
Float-free DRU	6 months after recording

## 1.2 Operating Procedure

### 1.2.1 How to turn the power on then record the data

#### Data Collecting Unit

<b>NOTICE</b>
<b>Do not open the DCU door unless authorized to do so.</b>
The DCU comes with a key to protect against any unauthorized access. The key must be kept securely by authorized personnel.

To start recording, open the DCU door with its key and turn on the AC and BATTERY switches in that order on the power control panel. Confirm that the AC SUPPLY MAINS LED and BATTERY BACKUP LED on the power control panel light. Data is automatically recorded in the Fixed DRU\*, Float-free DRU\* and long term device.

\*: Select one for VR-7000S.

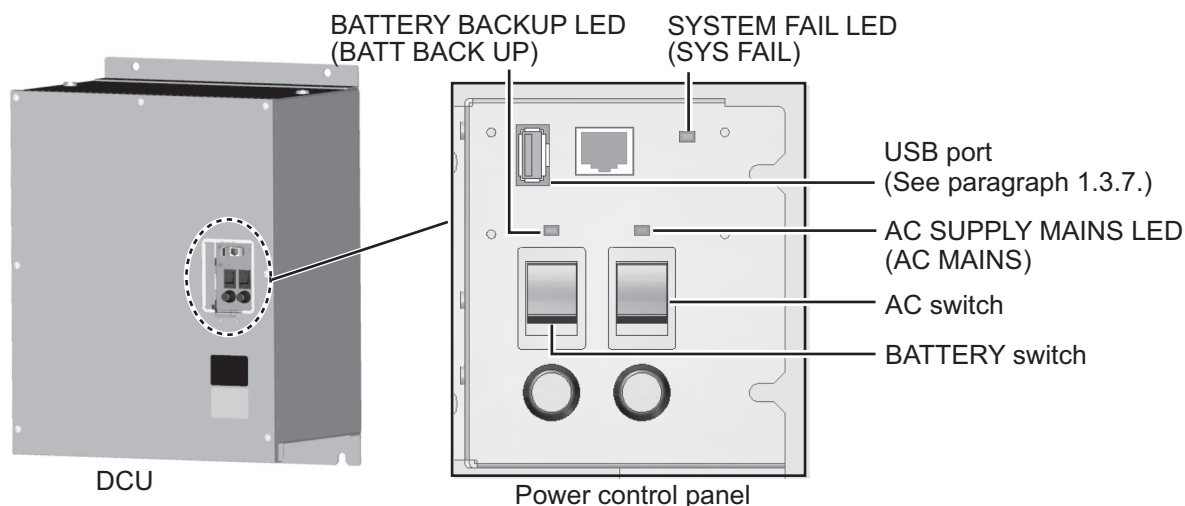

**Note 1:** When turning the power on at temperatures of 0 °C or lower, the DCU must be warmed before it can be operated, which takes a maximum of 30 minutes. The error message may appear on the screen of the VR-7017, however, this is not abnormal.

**Note 2:** If the VR-7000/7000S system fails to start, it may be restarted.

**Note 3:** Do not turn off the DCU power for 30 seconds after the power is turned on. Recorded data can be corrupted.

**Note 4:** Do not exert force on the opened DCU door. Force can damage the door.

**Note 5:** Do not connect multiple USB flash memories to the USB port via a USB HUB.

#### **Video LAN Converter (IF-7100)**

The video LAN converter converts the radar video signal to the LAN signal.

Turn the power on/off for the IF-7100 and the equipment connected to the IF-7100 (i.e. processor unit for radar or ECDIS) in the following order. Otherwise the IF-7100 may not function properly.

Power-on: Turn on the IF-7100 and the connected equipment in that order.

Power-off: Turn off the connected equipment and the IF-7100 in that order.

**Note:** The IF-7100 does not have a power switch. Turn off the IF-7100 from the main switchboard.

## 1.2.2 How to stop recording

Recording is terminated only under the following conditions:

- During essential maintenance while the vessel is in port.
- When the vessel is laid-up.

To stop recording, open the DCU door with its key and turn off the BATTERY and AC switches in that order. DO NOT turn off the system by the main breaker while the BATTERY switch is on. If only the AC switch is turned off, the system operates on the batteries. The system stops after recording the audio data only for two hours. When the AC power is supplied to the DCU again, the batteries are charged. The BATTERY BACKUP LED flashes while charging the batteries.

**Note:** After the power to the DCU is turned off, wait at least 10 seconds before reapplying the power. The DCU may not function correctly.

## 1.3 Operation on Remote Alarm Panel

### 1.3.1 Start screen and base screen

No power switch is provided on the Remote Alarm Panel; it is turned on and off by the power switch on the DCU. After the boot program screen appears, the start screen appears followed by the base screen.

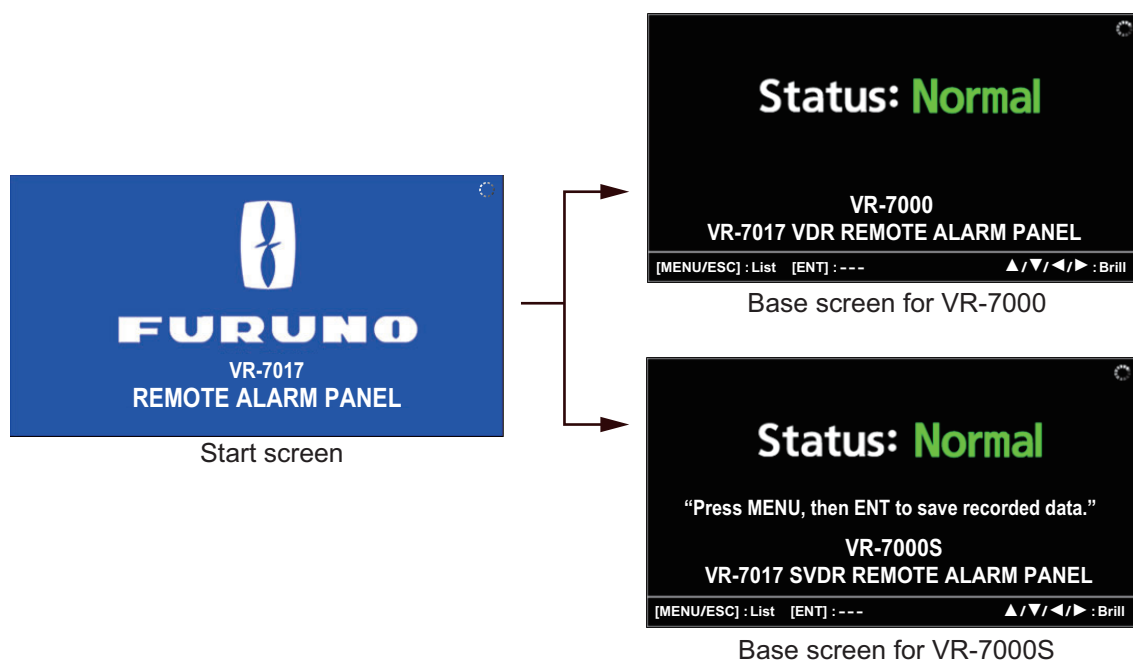

**Note:** When the DCU does not boot normally, it takes a maximum of 10 minutes to display the base screen. The error message "No DCU Connection" appears on the screen.

1. OPERATION

1.3.2 Controls



Control	Function
<b>BRILL</b>	<b>Short press:</b> Displays the [BRILL] setting window. <b>Long press:</b> Restores the brilliance of the LCD and keys to default.
<b>ACK</b>	Acknowledge an alert to stop the flashing of the alert list and silence the alert buzzer.
<b>TEST</b>	Opens the test menu.
<b>Extract</b>	Extracts the recorded data to the external media.
<b>MENU/ESC</b>	<b>Short press:</b> Opens/closes the menu, returns one layer in menu operation. <b>Long press:</b> Returns to the base screen except in pop-up displays (e.g. key beep, extraction related, etc.) and tests.
<b>ENT</b>	<ul style="list-style-type: none"> <li>• Confirms a selection.</li> <li>• Silences the alert buzzer temporarily when there are unacknowledged alerts. (The alert buzzer sounds again in 30 seconds after the buzzer stops.)</li> </ul>
<b>Cursorpad</b>	<b>Short press:</b> Selects a menu item, switches the page, adjusts the brilliance of the LCD and keys when the [BRILL] setting window opens. <b>Long press:</b> Moves the cursor continuously.

1.3.3 How to adjust the brilliance of the LCD and keys

1. Press the **BRILL** key to show the [BRILL] setting window.

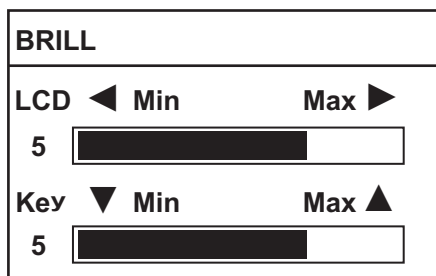

Setting ranges: 0 to 7  
Defaults: 5

2. To adjust the brilliance, use the cursorpad; ◀ or ▶ for the LCD, ▲ or ▼ for the keys.
3. Press the **ENT** or **MENU/ESC** key to close the setting window.



### 1.3.4 Alert list

The alert list provides information about active alerts.

Alert List			
	Alert ID	Alert Name	Time of last change
!	412324	No.08 Sensor(LAN	15:24:37
!	412323	No.07 Sensor(LAN	15:24:37
!	412322	No.06 Sensor(LAN	15:24:37
!	412321	No.05 Sensor(LAN	15:24:37
!	412320	No.04 Sensor(LAN	15:24:37

[MENU/ESC] : List [ENT] : Input ◀/▶ : Page ▲/▼ : Select

The list has multiple pages when more than five alerts are active. To view other alerts, use the cursorpad (◀ or ▶). The flashing cycle is 0.5 seconds.

To see the detailed information for an alert, use the cursorpad (▲ or ▼) to select the alert then press the **ENT** key.

Alert Detail		
Alert ID	Alert Name	Description
412324	No.02 Sensor(LAN	02 sensor(LAN) channel has not received correct format data from a connected sensor (LAN) device. Reconnect sensor(LAN) data. Check failed device.

[MENU/ESC] : Back ▲/▼ : Scroll

Use the cursorpad (▲ or ▼) to scroll the screen to see the hidden information.

Press the **MENU/ESC** key to close the detailed information screen.

All alerts are rectified, the base screen appears.

### 1.3.5 Main menu overview

1. Press the **MENU/ESC** key to open the main menu on the base screen or alert list.
2. Use the cursorpad (▲ or ▼) to select a menu item then press the **ENT** key.

<b>Execute SAVE Function</b>
Serial Monitor
Sensor(LAN) Monitor
Analog Monitor
Digital Monitor
Image Capture Status
Audio Monitor
Life Parts List
Status Monitor
Settings

← Only for VR-7000S

## 1. OPERATION

### **[Serial Monitor]**

You can monitor the sensor information input to the serial channels.

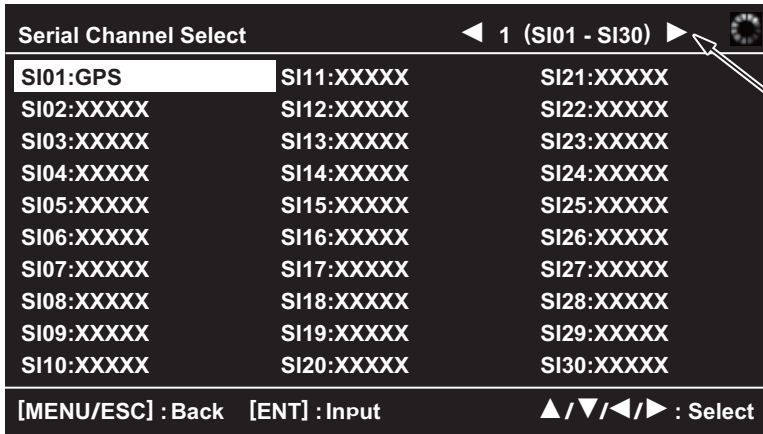

To shift the page, use the cursorpad (◀ or ▶).

To see the information for a serial channel, use the cursorpad to select a serial channel (SI01 to SI16) then press the **ENT** key to show the serial monitor screen. The latest received data is displayed on the top of the screen.

**Note:** A serial channel whose number is SI17 or later is no use.



To switch the channel, use the cursorpad (◀ or ▶).

Press the **ENT** key to stop the serial display. To restart the serial display, press the **ENT** key again.

### **[Sensor(LAN) Monitor]**

You can monitor the sensor information input to the LAN channels.

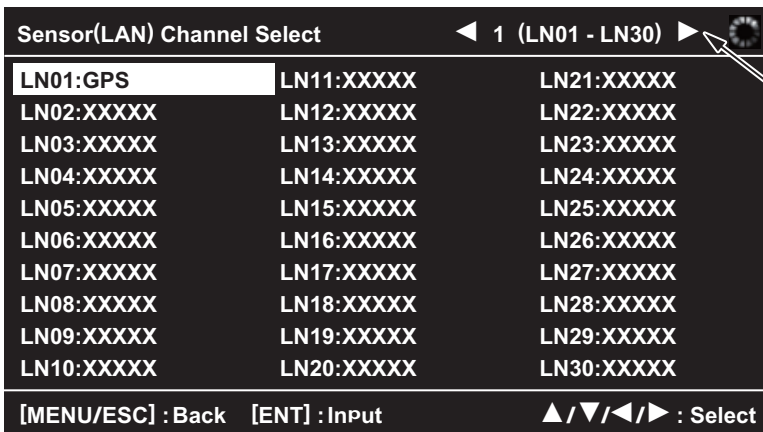

To shift the page, use the cursorpad (◀ or ▶).

To see the information for a sensor(LAN) channel, use the cursorpad to select a sensor(LAN) channel (LN01 to LN64) then press the **ENT** key to show the sensor (LAN) monitor screen. The latest received data is displayed on the top of the screen.



To switch the channel, use the cursorpad (< or >).

Press the **ENT** key to stop the sensor display. To restart the sensor display, press the **ENT** key again.

**[Analog Monitor]**

You can monitor the sensor information input to the analog channels (AN001 to AN120).

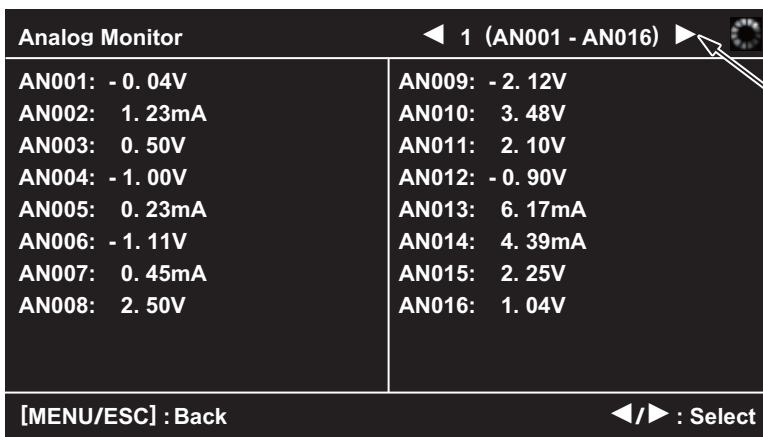

To switch the channel, use the cursorpad (< or >).

**[Digital Monitor]**

You can monitor the sensor information input to the digital channels (DC001 to DC640).

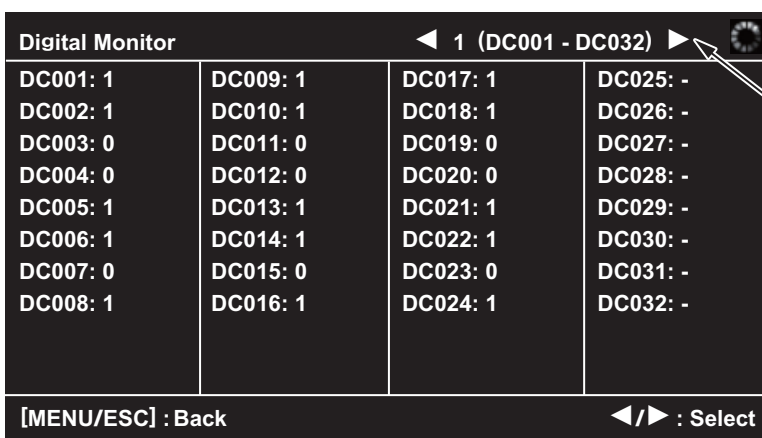

To switch the channel, use the cursorpad (< or >).

1. OPERATION

**[Image Capture Status]**

You can monitor the information of the images recorded in the DCU. The information for the image captures (the time and date when the image is captured to the VDR, captured image size, etc.) are updated.

Image Capture Status		
<b>Radar1</b>	<b>Radar2</b>	<b>ECDIS</b>
Captured Time: 01/09/2014 10:30:20	Captured Time: 01/09/2014 10:30:20	Captured Time: 01/09/2014 10:30:20
Source: Xband.1	Source: Sband.1	Source: ECDIS.1
Location: MFD0	Location: MFD0	Location: MFD0
Active: <b>Yes</b>	Active: <b>Yes</b>	Active: <b>Yes</b>
Resolution: 1280x1024	Resolution: 1280x1024	Resolution: 1280x1024
[MENU/ESC] : Back		

To switch the page, use the cursorpad (◀ or ▶).

**[Audio Monitor]**

You can check the status of the microphones and communications equipment (VHF, etc.).

Audio Monitor				
<b>VHF1</b>	<b>VHF2</b>	<b>MIC1</b>	<b>MIC2</b>	<b>MIC3</b>
Status: ---	Status: ---	Status: <b>MIC TestOK</b>	Status: <b>MIC TestNG</b>	Status: Not Connected
Level: □□□□□	Level: □□□□□	Level: ■■■■■	Level: ■■■□□	Level: □□□□□
<b>MIC4</b>	<b>MIC5</b>	<b>MIC6</b>	<b>MIC7</b>	<b>MIC8</b>
Status: <b>MIC TestOK</b>	Status: <b>MIC TestNG</b>	Status: <b>MIC TestNG</b>	Status: Not Connected	Status: <b>MIC TestOK</b>
Level: ■■■□□	Level: ■■■□□	Level: ■■■□□	Level: □□□□□	Level: ■■■□□
[MENU/ESC] : Back				

Microphone/VHF volume level

**[Life Parts List]**

You can check the lifetimes of the parts.

Life Parts List		
Type No.	Status	Expiry Date
VR-7020 Acoustic B	<b>OK</b>	2014/08
VR-7021F HRU	<b>OK</b>	2014/08
VR-7021F Battery M	<b>OK</b>	2014/08
VR-7010 Battery	<b>OK</b>	2014/08
[MENU/ESC] : Back		

When there are multiple pages, use the cursorpad (◀ or ▶) to shift the page.

**[Status Monitor]**

You can see the status of the system. Page 2 is only for VR-7000S.

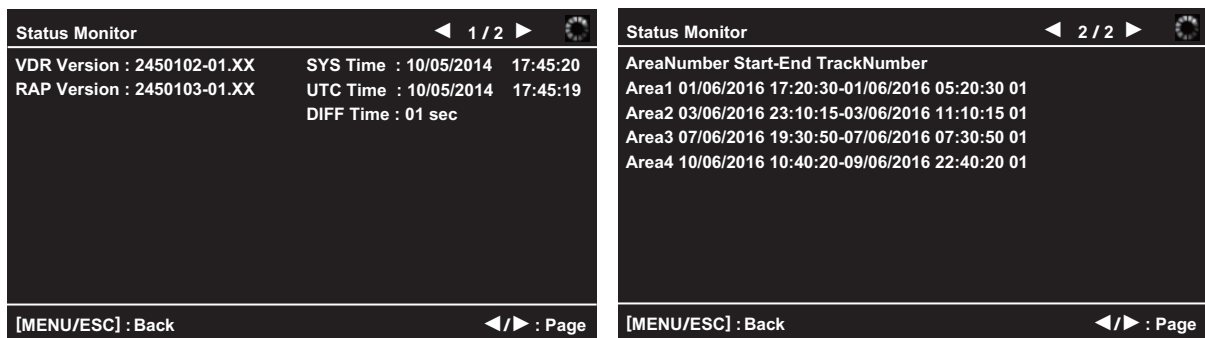
**[Settings]**

The [Settings] menu has menu items for the key beep sound and the brilliance sharing function.

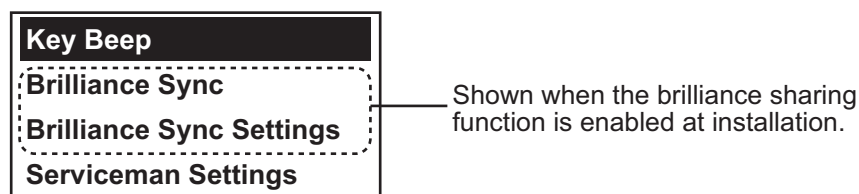

- [Key Beep]: When you operate a key, a single beep sounds. If you do not need the key beep, you can deactivate the beep sound. Use the cursorpad (◀ or ▶) to select [OFF] then press the ENT key.

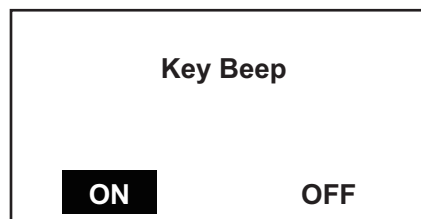

- [Brilliance Sync]: Turn the brilliance sharing function on or off. For details of the brilliance sharing function, see section 1.3.9.
- [Brilliance Sync Settings]: Adjust the preset setting value for the brilliance sharing. For details of the brilliance sharing function, see section 1.3.9.
- [Serviceman Settings]: No use.

**1.3.6 How to extract the recorded data to an external media**

Do the following to extract data to a USB flash memory.

**Note 1:** Do not remove the long term device(s) from the DCU unless authorized to do so. Extract the recorded data to the external media (a USB, etc.).

**Note 2:** To ensure smooth extraction of data to a USB flash memory, do the extraction when the ship is stopped. Vibration, pitching, rolling, etc. can prevent smooth extraction.

**Note 3:** All data in a USB flash memory is deleted.

**Note 4:** Use a USB flash memory formatted with FAT32. The USB flash memories in the following table have been tested:

1. OPERATION

Manufacturer	Model	Capacity	Manufacturer	Model	Capacity
Silicon Power	MARVELMO116GB	16 GB	ELECOM	MF-MSU3A04G	4 GB
HIDISK	HDUF101S128G3	128 GB		MF-TKU3016G	16 GB
TOSHIBA	UHYBS-032GH	32 GB	UNiSERB	PEUSB2-32G	32 GB
SanDisk	SDCZ33-064G-J57	64 GB	SONY	USM8GT	8 GB
I/O DATA	U3-AL16G	16 GB	BUFFALO	RUF3-K8GB	8 GB
	U3-AL8G	8 GB			

**Note 5:** Remove the USB flash memory only after the extraction is completed. Removing it during extraction may corrupt data in the next extraction. Further, abnormal data is played back.

**Note 6:** Do not extract the recorded data using the following steps when recording the data in the USB flash memory as the user disk. Extract the recorded data using the Live Player V5.

1. Open the DCU door with its key.
2. Insert a USB flash memory to the USB port.
3. Press the **Extract** key on the RAP.

Source Select
<b>Long Term Device</b>
Float DRU

VR-7000

Source Select
<b>Long Term Device</b>
Float DRU
<b>Area1 01/06/2016 17:20:30-01/06/2016 05:20:30 01</b>
<b>Area2 03/06/2016 23:10:15-03/06/2016 11:10:15 01</b>
<b>Area3 07/06/2016 19:30:50-07/06/2016 07:30:50 01</b>
<b>Area4 10/06/2016 10:40:20-09/06/2016 22:40:20 01</b>

VR-7000S

4. Use the cursorpad (▲ or ▼) to select the data source from [Long Term Device], [Float DRU] or [Area1 (2, 3, 4)] (only for VR-7000S) then press the **ENT** key.
  - [Long Term Device]: Long term device(s) in the DCU
  - [Float DRU]: Float-free DRU
  - [Area1 (2, 3, 4)]: Area1 to Area4 of long term device(s) in the DCU

**Note 1:** This function is not available for a Fixed DRU.

**Note 2:** Do not select [Float DRU] unless you can not extract the data from the long term device(s).

After selecting the data source, the following menu appears.

Extract Mode Select
<b>Target Date and Time Specify</b>
Extract Period Select

5. Use the cursorpad (▲ or ▼) to select [Target Date and Time Specify] or [Extract Period Select] then press the **ENT** key.
  - [Target Date and Time Specify]: Specify the date and time for the data to be extracted.
  - [Extract Period Select]: Set the extraction time.

6. Do the following procedure according to the menu option that is selected at step 5.

- [Target Date and Time Specify] is selected at step 5

The following setting window appears.

Target Date and Time Specify	
▲	
16 / 04 / 2019 15 : 20	
▼	
DD MM YYYY hh mm	

- 1) Use the cursorpad to specify the date for the data to be extracted then press the **ENT** key.

Target Date and Time Specify	
▲	
Range: +- 1 hour	
▼	
(1~6) hour	

- 2) Use the cursorpad to select the extraction time then press the **ENT** key.  
The data for the setting hours before and after the date specified at the previous step is extracted.  
After setting the extraction time, the following window appears.

Target Date and Time Specify	
16/04/2019 15:20	
+- 1 hour	
OK : [ENT] / Cancel : [ESC]	

- 3) Press the **ENT** key.

- [Extract Period Select] is selected at step 5

The setting window as shown to the right appears. Use the cursorpad (▲ or ▼) to set the extraction time\* (1 to 12 hour(s)) then press the **ENT** key.

\*: Backdated data is extracted, starting from the moment the **ENT** key was pressed.

Period Select
▲
1 hour
▼
(1~12) hour

After setting the extraction time, the following window that indicates the extraction data size and disk space appears.

Extract Size/Disk Space	
xxx, xxx, xxx, xxx byte/	<p>← Data size* is displayed as an hour even if object data time is smaller than an hour.</p> <p>← Disk space is displayed in red when it is smaller than extraction data size.</p>
xxx, xxx, xxx, xxx byte	

\*: "0 byte" may be displayed when the specified extraction period includes the time zone that does not have recorded data. Even if the data size is "0 byte", perform the following steps. The data may be extracted if the recorded data is included in specified extraction period.

## 1. OPERATION

**Note:** If the following window appears, check that the USB flash memory is properly inserted and is formatted to FAT32. Then press the **ENT** key and restart the procedure from step 4.

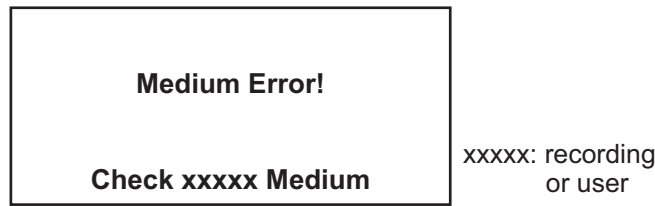

7. Press the **ENT** key. The confirmation window appears.



8. Use the cursorpad (◀ or ▶) to select [Yes] then press the **ENT** key. The window changes as follow.

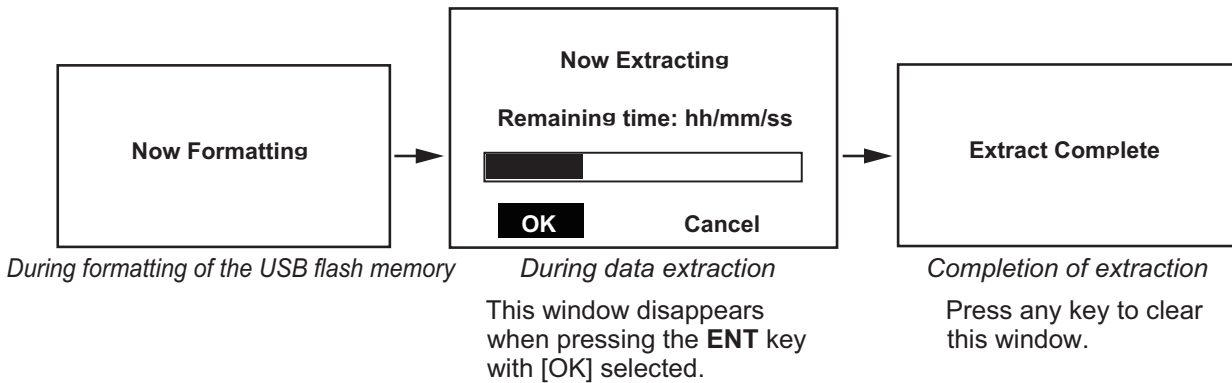

**Note 1:** If an error occurs during the formatting of the USB flash memory, the message "Format Error! Extract Canceled" appears. Press any key to clear the message then check the USB flash memory.

**Note 2:** If an error occurs during data extraction or there is no recorded data, the message "Extract Error! Extract Canceled" appears.

9. Lock the DCU door after the data is extracted.

### 1.3.7 How to record the data to a USB flash memory

Data which is recorded to the capsule can be recorded to a USB flash memory as the user disk. Insert a USB flash memory to the USB port on the power control panel (see paragraph 1.2.1). The recording time is from 72 to 720 hours, at 72 hours intervals. Have a qualified technician initialize USB flash memory before use. For details, contact your dealer.

During recording to a USB flash memory, if alert numbers 412504 or 412514 occur (see section 3.2), remove then reconnect the USB flash memory. If the error occurs again during recording, contact your dealer for service.

**Note:** Do not use the RAP to record data when recording to a USB flash memory.



### 1.3.8 How to execute SAVE function for recorded data (only for VR-7000S)

If marine incidents occur, record the data, which are recorded to the capsule, to area1 (or 2, 3, 4) in the long term device(s). When all areas are used, the memory for the oldest area is automatically overwritten with the new memory in order from the oldest area.

1. Press the **MENU/ESC** key to open the main menu.
2. Use the cursorpad (**▲** or **▼**) to select [Execute SAVE Function] then press the **ENT** key. The window changes as follow.

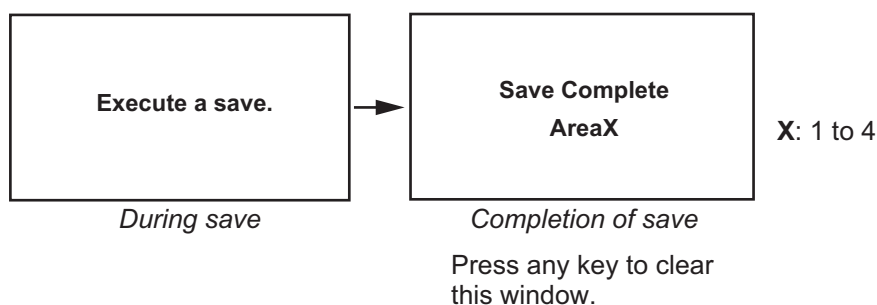

**Note 1:** If the save processing fails, the message "Save Error" appears. When the save processing can not be executed, the message "DCU setting to be checked for SAVE function." appears. When this message appears, contact your dealer.

**Note 2:** The recording to the long term device(s) does not stop when all areas are used.

**Note 3:** The SAVE execution does not affect the recording operation for the long term device(s) or the connected DRU.

### 1.3.9 Brilliance sharing function

The RAP can share the brilliance settings with EC-3000 units (ex: ECDIS, chart radar) in the same network. When you adjust the brilliance of the EC-3000 units, the brilliance of the RAP is automatically changed. Note that the brilliance of the EC-3000 units is not changed according to the RAP brilliance change.

To turn the brilliance sharing function on or off, do as follows.

**Note:** The VDR software version must be "01.40" or after to use the brilliance sharing function. Also, it is required to enable the function from the service menu. For details, contact your dealer.

1. Press the **MENU/ESC** key to open the main menu.
2. Use the cursorpad (**▲** or **▼**) to select [Settings] then press the **ENT** key.

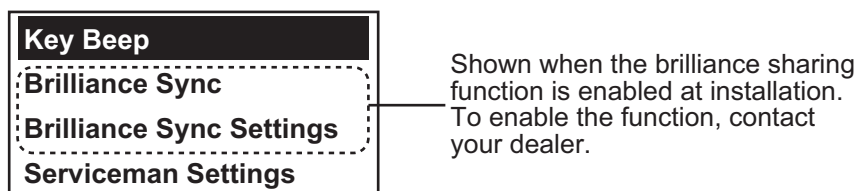

3. Use the cursorpad (**▲** or **▼**) to select [Brilliance Sync] then press the **ENT** key.

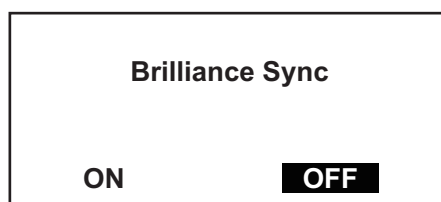

## 1. OPERATION

4. Use the cursorpad (◀ or ▶) to select [ON] or [OFF] then press the **ENT** key.  
To turn the brilliance setting function, select [ON].
5. Use the cursorpad (▲ or ▼) to select [Brilliance Sync Settings] then press the **ENT** key.
6. Adjust the preset brilliance of the LCD and keys for the day, dusk and night.

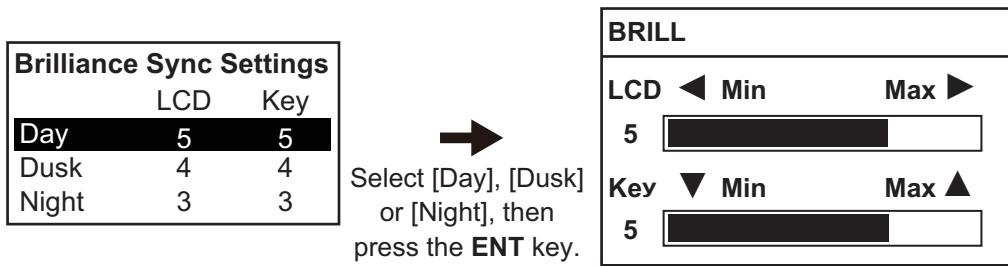

## 1.4 How to Release the Fixed DRU

To release the Fixed DRU from its bracket (cradle), do the following:

1. Turn off the BATTERY and AC switches in that order to turn off the DCU power.
2. Remove the release pin.
3. Lift the release lever.
4. Lift the handle to separate the top of the DRU from the bottom of the DRU.
5. Cut the cable connected between the top and bottom of the DRU.

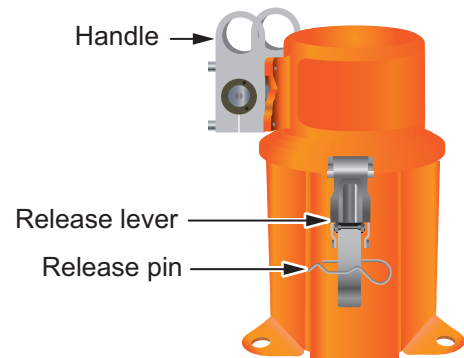

## 1.5 How to Release the Capsule from the Bracket of the Float-free DRU in Emergency Situation

In an emergency situation, release the capsule from the bracket of the Float-free DRU to remove the capsule if possible.

**Note 1:** Do not drop the capsule from a high place.

**Note 2:** Do not release the capsule other than in an emergency situation or maintenance. The silicone grease is applied to the bottom of the capsule to prevent water and foreign materials from entering into the gap between the capsule and bracket. After you release the capsule, apply the specified silicone grease (type:100946, code no.: 001-365-040) to the capsule before reattaching it (see page 22).

1. Release the safety clip and remove the cover of the bracket.



2. Grasp the antenna of the capsule, then pull out it.

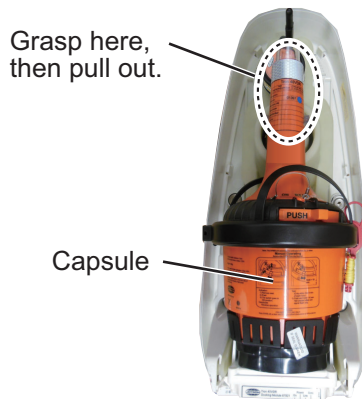

3. Put the capsule in an emergency bag and take it to a life raft.

**Note:** The wrist strap may be equipped to the capsule, depending on the time of manufacture. The capsule can be carried by using the provided wrist strap, where it is necessary to have both arms free, e.g. when climbing a ladder. The wrist strap can be pulled out of the pocket and your arm can be placed through it. It is not possible to put the wrist strap back into the pocket after usage.

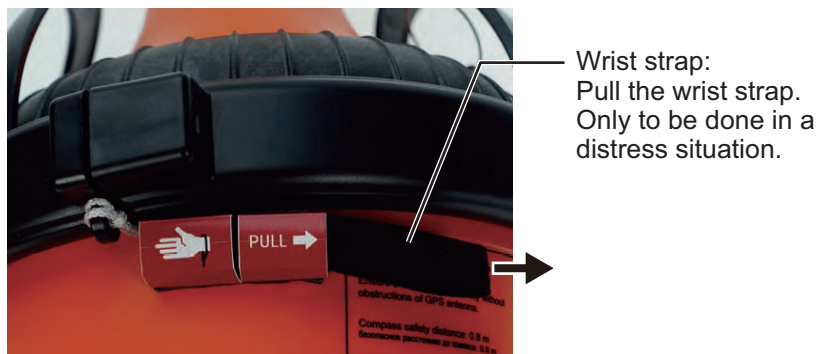

4. If there is a satellite EPIRB on the life raft (excluding the capsule of the Float-free DRU), tie its towing rope to the life raft and float it on the sea.  
The satellite EPIRB activates and flashes its lamp every three seconds. The satellite EPIRB operates for at least 48 hours, and the satellite EPIRB transmits 406 MHz signal for distress every 50 seconds to a polar orbit satellite. If the satellite EPIRB has a built-in GPS, a locating signal is transmitted to a stationary satellite. Also, the satellite EPIRB transmits 121.5 MHz signal for homing.  
**Note:** It is not required to activate the capsule of the Float-free DRU when the satellite EPIRB is in operation.
5. When the satellite EPIRB has stopped its operation or there is not a satellite EPIRB on a life raft, tie the towing rope of the capsule of the Float-free DRU to the life raft and float the capsule on the sea.  
The capsule of the Float-free DRU activates and transmits 406 MHz signal for locating the position of the capsule and 121.5 MHz signal for homing for at least 168 hours.
6. Upon completion of the rescue operations, pass the capsule to the rescue team for analysis of the data in the capsule.

### **After picking up the capsule**

After picking up the capsule from the sea, dry it with a towel. When the capsule is dried, its lamp stops flashing. Pass the capsule to the investigating authorities through the search and rescue team. The investigating authorities extract and analyze the data in the capsule.

## 1. OPERATION



### **Disposal of the capsule**

The capsule must be discarded properly after extracting and analyzing the data. Vertically separate the capsule. For the bottom of the capsule, cut the battery's lead wires and wrap the vinyl tape around the wires to insulate them. For the upper part of the capsule dispose of the electronic parts according to local regulations for the disposal of industrial waste.

## 2. MAINTENANCE

---

Regular maintenance is important to maintain performance. This chapter contains maintenance instructions to be followed to obtain optimum performance and the longest possible life of the equipment.

 <b>WARNING</b>	<b>NOTICE</b>
 <b>ELECTRICAL SHOCK HAZARD</b> <b>Do not open the DCU cover.</b>  Only qualified personnel should work inside the equipment.	<b>Do not apply paint, anti-corrosive sealant or contact spray to coating or plastic parts of the equipment.</b>  Those items contain organic solvents that can damage coating and plastic parts, especially plastic connectors.
 <b>Do not disassemble or modify the equipment.</b>  Fire, electrical shock or serious injury can result.	

### 2.1 General Maintenance and Cleaning

Dirt or dust may be removed from units with a soft cloth. Fresh water-moistened cloth may be used to remove stubborn dirt. DO NOT use any commercial cleaning agents to clean any unit. They can remove paint and markings.

**Remote Alarm Panel VR-7017:** Wipe the LCD of VR-7017 carefully to prevent scratching, using tissue paper and an LCD cleaner. To remove dirt or salt deposits, use an LCD cleaner, wiping slowly with tissue paper so as to dissolve the dirt or salt. Change paper frequently so the salt or dirt will not scratch the LCD. Do not use solvents such as thinner, acetone or benzene for cleaning. Also, do not use degreaser or anti-fog solution, as they can strip the coating from the LCD.

**Waterproof Microphone VR-7012W:** The watertight integrity of the microphone will be compromised if water contacts the ventilation sheet behind the MIC cover.

**Fixed DRU VR-7021:** Check the adhesive (silicone sealant) on the mounting bolt, nut and cable gland to confirm that the adhesive is not deteriorated, every three to six months. When deteriorated, reapply the adhesive. If severely deteriorated, remove all adhesive before reapplying. Deteriorated adhesive may cause water leakage or electrolytic corrosion.

## 2.2 Maintenance of the Float-free DRU

The capsule of the Float-free DRU transmits the signal similar to the distress signal of a satellite EPIRB. Therefore, trouble to the search and rescue authorities may occur if the capsule accidentally transmits the signal. If accidental transmission occurs, stop the transmission and inform the search and rescue authorities of the accidental transmission.

Contact information	
A (cellular) telephone is usable in Japanese coastal waters.	118 or 03-3591-9000 (Japan Coast Guard)
You can contact with the coast guard using the marine VHF band (within 25 miles from the coast).	Use the radio telephone of VHF channel 16 to contact the coast guard.
You can contact with the coast guard using the radio telephone of MF 2182 kHz (within 150 miles from the coast).	Use the radio telephone of MF 2182 kHz to contact the coast guard.
A satellite radio telephone like a Inmarsat is usable.	<ul style="list-style-type: none"> <li>Contact with the search and rescue authorities in each flag state.</li> <li>For Japanese-flagged vessel, contact Japan Coast Guard at 81-3-35919000.</li> </ul>
Things to inform	
Ship's name, call sign, MMSI, time, location, fact of the accidental transmission and own contact information.	

### 2.2.1 Monthly maintenance and self test

Do the maintenance and self test every month.

**Note:** Attach the cover to the bracket correctly after the maintenance, referring to "How to attach the cover" on page 25. If the cover is not attached correctly, the cover and capsule may drop out of the bracket due to wind and/or vibration.

#### Notice for the maintenance and self test

- There are two electrodes at the back of the capsule (see right figure). If these electrodes are shorted by water with the capsule released from the bracket, the capsule may transmit the signal accidentally. Therefore, do not wash the capsule with water or release the capsule in rain and rough seas. When the capsule is seated in the bracket correctly, the electrodes are invalid. So, the capsule does not transmit the signal if the capsule get splashed with water.
- You can do the self test with the capsule seated in the bracket. However, the capsule can not transmit the test signal and test result may be "NG" when the bracket is fastened to a steel plate. In this case, release the capsule from the bracket and do the self test again.

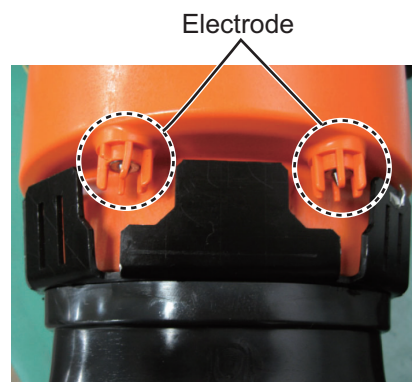

**Note:** Silicone grease is applied to the bottom of the capsule (see the next page). When you release the capsule during the self test, hold the capsule by its handle to prevent foreign material from contacting the grease. If foreign material contacts the grease, wipe off the grease, then reapply the specified silicone grease (type:100946, code no.: 001-365-040).

- The capsule transmits 406 MHz test signal. This signal does not initiate search and rescue operations because the satellites recognize it as a test signal. However, do not do the self test more than necessary.

- The capsule transmits 121.5 MHz homing signal in the self test. Aircrafts receive this homing signal. Do the self test five minutes every hour on the hour because the homing signal is recognized as a test signal during this time period.
- You can maintain the Float-free DRU and do the self test with the VDR powered. However, the capsule should be returned to the bracket within 10 minutes after its release. The data buffer of the VDR can retain the data of the latest 10 minutes. If more than 10 minutes passes after releasing the capsule, the data of 10 minutes before the capsule is returned to the bracket is lost. At this time, the communication error with the Float-free DRU appears on the remote alarm panel. Finish any maintenance and diagnosis as quickly as possible to be prepared in case of an unexpected emergency and prevent loss of data.
- Apply the appropriate silicone grease between the docking module and storage module before reattaching the capsule, to prevent water and foreign materials from entering into the gap between the docking module and storage module. If foreign material contacts the modules, electrostatic capacity may change, preventing recording of data.

**Note:** Silicone grease is stored around the DCU after installing the Float-free DRU. Use the tube labeled "Item no.88237 Tron 40VDR". Use only the specified silicone grease (type: 100946, code no.: 001-365-040). If the silicone grease is empty or lost, contact your dealer.

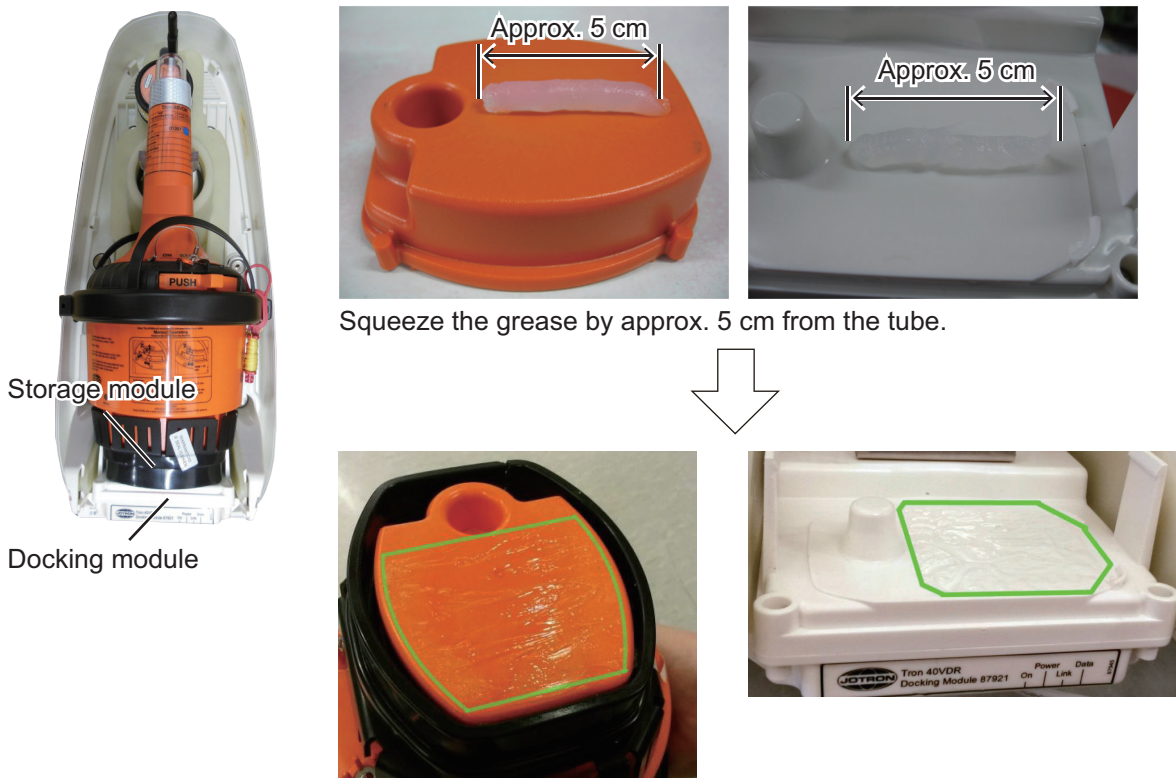

Squeeze the grease by approx. 5 cm from the tube.

Apply the grease evenly to the areas surrounded by the line.



## 2. MAINTENANCE

- Do not use force to reattach the capsule and bracket cover. Also, confirm that there is no space or foreign material between the storage module and docking module (see figure below). If the capsule is not seated in the bracket correctly, the communication error occurs on the remote alarm panel after 10 minutes and the capsule may transmit the signal because that the electrodes are shorted by water.

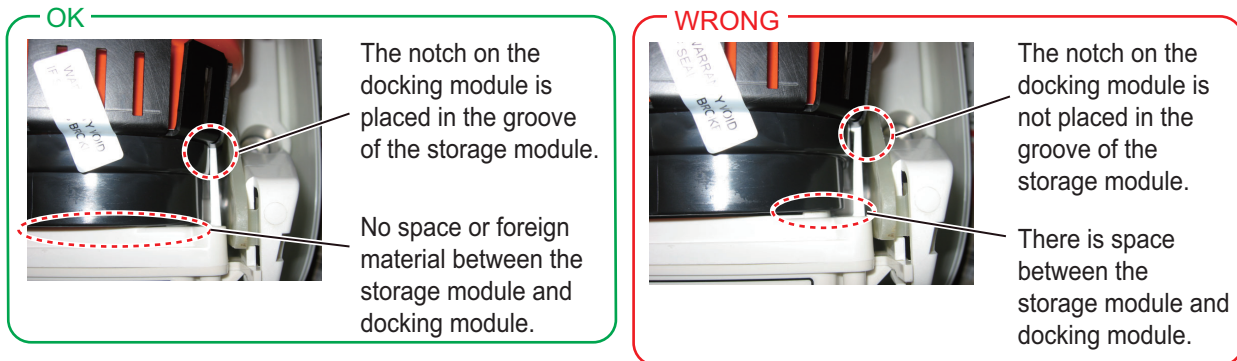

- Confirm that the error related to the Float-free DRU does not occur after the maintenance.
  - The flash lamp flashes at three second intervals when the capsule is transmitting the signal. If, during maintenance, the signal is accidentally transmitted, dry the electrodes of the capsule with a towel, then return it to the bracket. If the signal is still being transmitted, take the capsule to a steel cabin. Then, inform the search and rescue authorities of the accidental transmission.
- Note:** The Float-free DRU does not have a power switch. If the flash lamp continues flashing in spite of the above measures, remove the internal battery from the capsule.

### Maintenance point and self test

Maintenance point		Result
Around the bracket	Confirm that there is no object or structure which can interrupt the release of the capsule.	
	Confirm that the cable connected to the bracket is fixed correctly.	
	Confirm that the bracket is fixed to the mounting location and fixing bolts are fastened firmly.	
Appearance of the bracket	Confirm that the bracket is not damaged and the characters inscribed on the bracket are readable.	
	Confirm that no paint is applied to the bracket.	
Inside the bracket	Confirm that water has not entered into the bracket.	
	Confirm that there is no damage to the capsule, and all external parts (stickers, etc.) are in place.	
	The expiration date for the battery and hydrostatic release unit is as follows: <ul style="list-style-type: none"> <li>Battery: Five years (from date of coding or replacement)</li> <li>Hydrostatic release unit: Two years (from date of coding or replacement)</li> </ul> The expiration date is indicated on the sticker attached to the capsule and hydrostatic release unit. Confirm that the expiration date has not passed.	

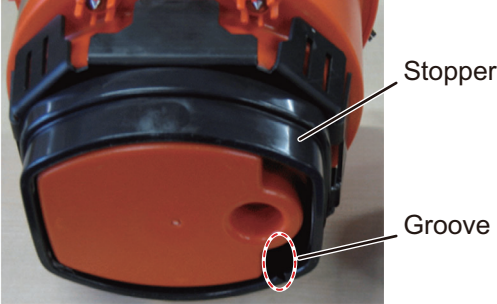
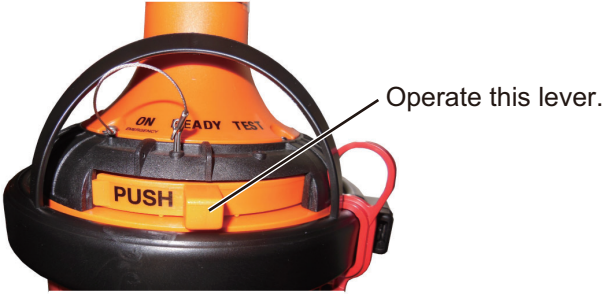

<b>Maintenance point</b>		<b>Result</b>																
<p>Inside the bracket</p>	<p>Confirm that the stopper at the bottom of the capsule is not damaged, and there is no crack on the groove. The stopper secures the battery case and storage module to the capsule. There is a groove on the stopper. When replacing the battery, cut the groove to remove the battery case. If the stopper is damaged or there is a crack on the groove, the stopper may not secure the battery case and storage module firmly. Contact your dealer to replace the stopper.</p> 																	
<p>Normal self test</p>	<p>Do the self test as follows: <b>Note:</b> Hold the capsule by its handle during the test. This keeps foreign material away from the silicone grease on the capsule, and keeps the antenna of the capsule away from metallic objects or human body.</p> <ol style="list-style-type: none"> <li>1) Remove the capsule from the bracket.</li> <li>2) Push and hold the lever in "TEST" position for 15 seconds.</li> </ol>  <ol style="list-style-type: none"> <li>3) The lamp flashes once if operation is normal. Multiple flashes indicate error. See the table below for number of flashes and error.</li> </ol> <table border="1" style="margin-left: auto; margin-right: auto;"> <thead> <tr> <th style="text-align: center;">Number of flashes</th> <th style="text-align: center;">Result</th> </tr> </thead> <tbody> <tr> <td style="text-align: center;">1</td> <td>OK.</td> </tr> <tr> <td style="text-align: center;">2</td> <td>Low power on 406 MHz transmitter.</td> </tr> <tr> <td style="text-align: center;">3</td> <td>Low battery voltage.</td> </tr> <tr> <td style="text-align: center;">4</td> <td>Low power on 121.5 MHz transmitter.</td> </tr> <tr> <td style="text-align: center;">5</td> <td>Frequency error on 406 MHz transmitter.</td> </tr> <tr> <td style="text-align: center;">6</td> <td>Frequency error on 121.5 MHz transmitter.</td> </tr> <tr> <td style="text-align: center;">7</td> <td>EPIRB module is not programmed or programming is not completed.</td> </tr> </tbody> </table> <p>When the result of the self test is not "OK", change the location and re-try the self test. If not resolved, contact your dealer.</p> <ol style="list-style-type: none"> <li>4) Release the lever and set it to the "READY" position. Check if there is sufficient silicone grease at the bottom of the capsule and that the grease is free of foreign material. If there is no grease or the grease contains foreign material, wipe off the grease and then reapply the specified silicone grease (type:100946, code no.: 001-365-040).</li> </ol>	Number of flashes	Result	1	OK.	2	Low power on 406 MHz transmitter.	3	Low battery voltage.	4	Low power on 121.5 MHz transmitter.	5	Frequency error on 406 MHz transmitter.	6	Frequency error on 121.5 MHz transmitter.	7	EPIRB module is not programmed or programming is not completed.	
Number of flashes	Result																	
1	OK.																	
2	Low power on 406 MHz transmitter.																	
3	Low battery voltage.																	
4	Low power on 121.5 MHz transmitter.																	
5	Frequency error on 406 MHz transmitter.																	
6	Frequency error on 121.5 MHz transmitter.																	
7	EPIRB module is not programmed or programming is not completed.																	

## 2. MAINTENANCE

Maintenance point		Result								
Extended self test (normal self test and GPS test)	<p>The extended self test involves both the normal self test and GPS test. Do the extended self test as follows:</p> <p><b>Note:</b> The extended self test reduces the lifetime of the battery. Do this test once every three months.</p> <ol style="list-style-type: none"> <li>1) Remove the capsule from the bracket.</li> <li>2) Move the lever to "TEST" position twice within 3 seconds and return it to "READY" position. The GPS test starts and a short beep sounds every 3 seconds until GPS position is acquired. The GPS test may take up to 2 minutes.</li> <li>3) Two beeps sound for normal operation. Multiple beeps sound for error, as shown in the table below.</li> </ol> <table border="1" data-bbox="469 584 1163 723"> <thead> <tr> <th>Number of beep</th> <th>Result</th> </tr> </thead> <tbody> <tr> <td>2</td> <td>OK.</td> </tr> <tr> <td>5</td> <td>GPS positioning error.</td> </tr> <tr> <td>10</td> <td>Number of GPS test exceeds the limit.</td> </tr> </tbody> </table> <ol style="list-style-type: none"> <li>4) The normal self test is started after the GPS test. Confirm that the flash lamp flashes once. When the result of the self test is not "OK", change the location and do the normal self test. If not resolved, contact your dealer.</li> <li>5) Check that the grease at the bottom of the capsule is sufficient and free of foreign material. Reapply if necessary. Return the capsule to the bracket.</li> </ol>	Number of beep	Result	2	OK.	5	GPS positioning error.	10	Number of GPS test exceeds the limit.	
Number of beep	Result									
2	OK.									
5	GPS positioning error.									
10	Number of GPS test exceeds the limit.									
Around the data transmitter	Confirm that there is no foreign materials between the storage module and docking module.									
	Confirm that the silicone grease is applied to the gap between the storage module and docking module.									
After reattaching the capsule	Confirm that the capsule is seated in the bracket correctly and there is no space between the storage module and docking module.									
	Confirm that the bracket cover and safety clip are attached.									
Alert	Confirm that the communication error with the Float-free DRU does not appears on the remote alarm panel. This alert appears when the VDR can not record the data to the capsule for 10 minutes. Seat the capsule to the bracket correctly to rectify the alert.									

### How to attach the cover

Attach the cover to the bracket as follows after the maintenance. If the cover is not attached correctly, the cover and capsule may drop out of the bracket due to wind and/or vibration.

1. Fit the notch on the cover with the ridge on the bracket.

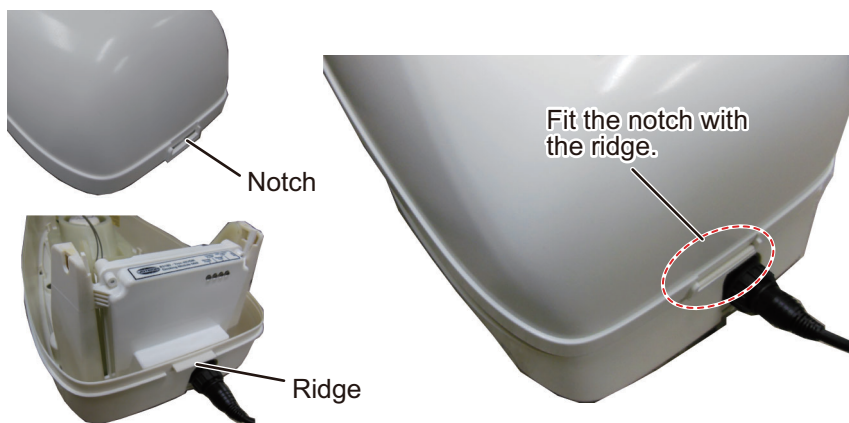

- There is a groove alongside the cover that has to be aligned and fit around the tongue on the bracket. Align the tongue on the bracket and groove alongside the cover.

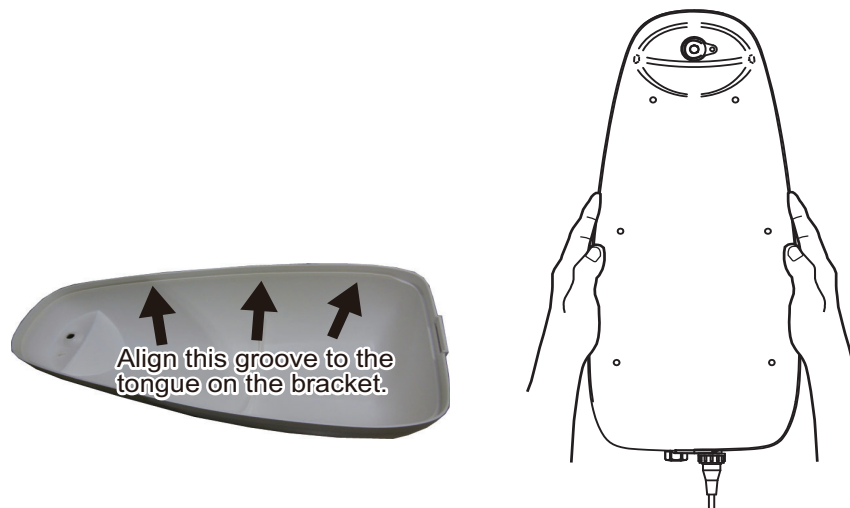

- Attach the cap to the hole at the top of the cover, then insert the safety clip.  
**Note:** Make sure the safety clip is mounted correctly, referring to the following figure.

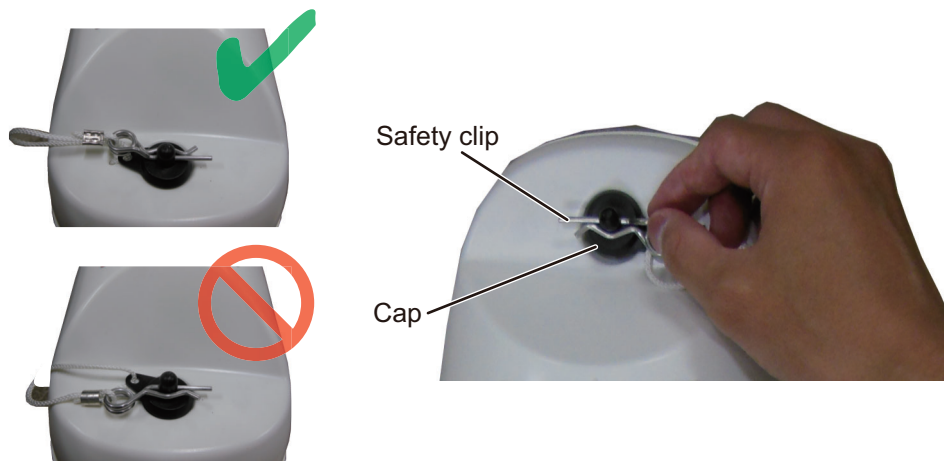

## 2.2.2 Annual Performance Test for the Float-free DRU

The Float-free DRU must undergo an annual performance test because it is a part of the VDR system. Annual performance test is defined in the regulation of SOLAS. For Japanese-flagged vessel, the radio inspection is required by the Ministry of Internal Affairs and Communications.

### For foreign-flagged vessel

All units in the VDR system must undergo an annual performance test. This test is conducted by a test engineer authorized by the manufacturer and certified by a relevant ship classification society. The EPIRB performance test for the Float-free DRU is conducted by an engineer or service provider responsible for Jotron's Tron40S MkII/Tron40GPS.

### For Japanese-flagged vessel

For Japanese-flagged vessel, the radio inspection is required by the Ministry of Internal Affairs and Communications. This inspection is conducted by an engineer authorized by the Ministry of Internal Affairs and Communications, such as GMDSS service station of the Japan Ship-Machinery Quality Control Association. For the VDR annual performance test and Float-free DRU performance test is conducted by an engineer authorized by the Ship's Electric Installation Contractors' Association of Japan.

### 2.2.3 Shore-Based Maintenance (SBM)

The capsule of the Float-free DRU has the same functionality of an satellite EPIRB (Emergency Position-Indicating Radio Beacon). So, it is required to conduct the Shore-Based Maintenance (SBM) within five years from installation or previous SBM. The SBM is not defined in the regulation. However, do the SBM to keep the performance. Also, the battery in the capsule must be replaced during the SBM because the expiration date of the battery is five years from manufacture or replacement date. Ask a workshop responsible for the satellite EPIRB to conduct the SBM.

## 2.3 Annual Recertification

All units in the VDR system must undergo an annual performance test, in accordance with SOLAS regulations. This test is conducted by a test engineer authorized by the manufacturer and certified by a relevant ship classification society.

### For foreign-flagged vessel

Contact a test engineer authorized by the manufacturer and certified by a relevant ship classification society for the VDR annual performance test.

### For Japanese-flagged vessel

Contact a service station of the Japan Ship-Machinery Quality Control Association for the VDR annual performance test.

### Remote analysis

1. The remote analysis request window, as shown in the figure to the right, appears.

**Note:** While the request window is displayed, a beep sounds every 30 seconds.



[Yes]: Start the remote analysis. Go to step 2.

[Later]: The window for request of remote analysis appears again after 30 seconds. If OK, go to step 2.

[No]: Cancel the remote analysis. The message "Remote Analysis not performed" appears. Press any key to clear the window.

2. Select [Yes] then press the **ENT** key.

The remote analysis information window, as shown in the figure below, appears.

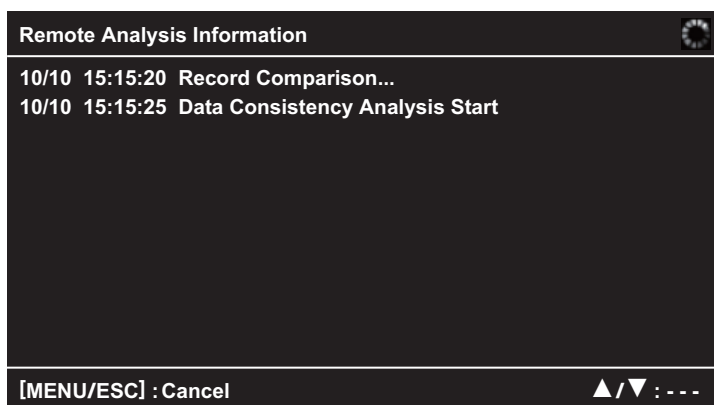

“Scroll” is displayed when the information is over the screen.

When you want to use the SAVE function, remote analysis must be cancelled first. Press the **MENU/ESC** key to cancel the remote analysis anytime. The message "Remote Analysis Cancel?" appears. Press the **ENT** key. The message "Remote Analysis Canceled" appears. Press any key to clear the window.

- When the remote analysis finishes, the message "Remote Analysis Finished" appears. Press any key to clear the window.

## 2.4 Fuse Replacement

The DCU VR-7010, Video LAN Converter IF-7100 and Sensor Adapter MC-3000S have fuses that protect them from high electric current and equipment fault. If you cannot turn on the power to a unit, check its fuse to see if it has blown. If the fuses for the DCU have blown, replace them with the specified fuses (see page AP-3 for the fuse location). If the fuses blow again after replacement, contact a FURUNO agent or dealer. Have a qualified technician replace the fuse for Video LAN Converter and Sensor Adapter.

 **WARNING**

 **Use the correct fuse.**  

A wrong fuse can cause fire or serious damage to the equipment.

Unit	Name	Type	Code No.	Remarks
VR-7010	Glass Tube Fuse	FGBO-A 250V 10A PBF	000-155-839-10	For battery
				For AC power
IF-7100	Glass Tube Fuse	FGMB-A 125V 2A PBF	000-157-479-10	
MC-3000S	Glass Tube Fuse	FGMB-A 125V 3A PBF	000-157-481-10	

## 2.5 Consumable Parts

You can check the lifetimes of the consumable parts on the RAP screen (see "[Life Parts List]" on page 11). Contact your dealer to replace the consumable parts.

Unit	Name	Type	Interval	Indication on the RAP
VR-7010	Battery	CY1-1487-01	4 years	"VR-7010 Battery"
VR-7020	Acoustic Beacon	PT9 NINETY	3 years	"VR-7020 Acoustic B"
VR-7021F	Battery	X-89340	5 years	"VR-7021F Battery M"
	Hydrostatic Release Unit	X-86218	2 years	"VR-7021F HRU"

**Note:** Dispose of the battery in accordance with local regulations.

**⚠ WARNING**

**Battery handling precautions**

- Do not attempt to disassemble the battery. If accidental skin/eye contact is made with the battery fluid, wash the affected area/part immediately with liberal amounts of clean fresh water and seek IMMEDIATE medical attention.
- DO NOT INCINERATE batteries as they are liable to rupture if placed into a fire. Batteries that have reached the end of their service life must be disposed of in accordance with appropriate regulations.
- Do not short battery terminals. Short can lead to bursting or fire.

**⚠ CAUTION**

**Do not:**

- use batteries of different capacities
- mix old batteries with new
- mix batteries of different makes

Batteries themselves may become damaged or damage to electrical parts may result.

## 2.6 Self Test

The self test checks the ROM, RAM, connection, program no., keyboard, LCD performance and buzzer. The user can do the tests to help the service technician in troubleshooting.

### How to open the test menu

Press the **TEST** key on the RAP to show the test menu.

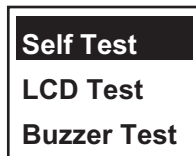

### Self test

1. Open the test menu.
2. Use the cursorpad (▲ or ▼) to select [Self Test] then press the **ENT** key.

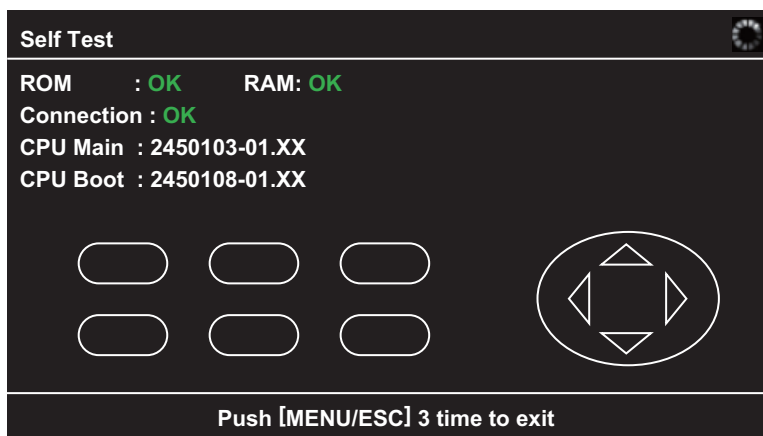

**Note:** The self test screen closes automatically when there is no menu operation for 60 seconds.

- Press each key one by one. A key's corresponding location on the display is colored if the key is normal.
- Press the **MENU** key three times to close the self test screen.

### **LCD test**

- Open the test menu.
- Use the cursorpad (▲ or ▼) to select [LCD Test] then press the **ENT** key. Each press of the **ENT** key changes the LCD pattern in the sequence shown below.

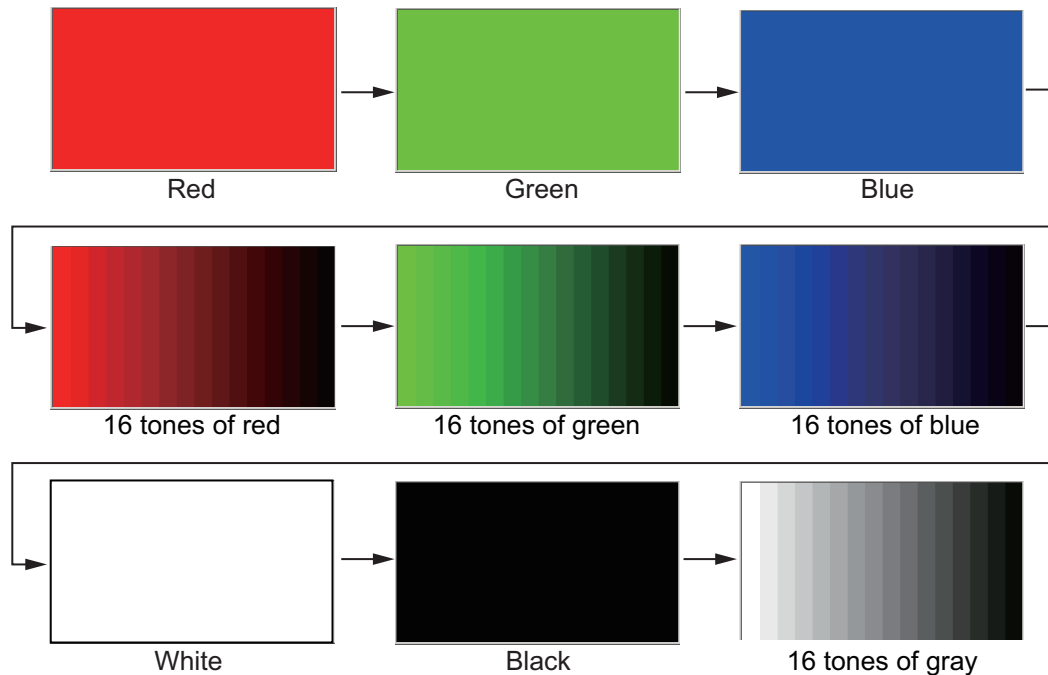

**Note 1:** The LCD test screen closes automatically when there is no menu operation for 60 seconds.

**Note 2:** You can cancel the test at any time by pressing the **MENU** key.

- Press the **MENU** key to close the LCD test screen.

### **Buzzer test**

- Open the test menu.
- Use the cursorpad (▲ or ▼) to select [Buzzer Test] then press the **ENT** key. The buzzer test window appears then a buzzer sounds for 60 seconds.

<b>Buzzer Test</b>
<b>A buzzer is sounded for 60 seconds.</b>

**Note 1:** The buzzer test window closes automatically when there is no menu operation for 60 seconds.

**Note 2:** You can cancel the test at any time by pressing any key.

## 2.7 Verification of Recording Function of the Long Term Device

Verify the long term device recording function at the annual inspection and when repairing or maintaining the VDR or sensors connected to the VDR. The verification requires the Live Player V5. Refer to its Operator's Manual for the operating procedure.

1. Start the Live Player V5 on the PC.
2. Connect the LAN cable between J502 port on the DCU and the PC.

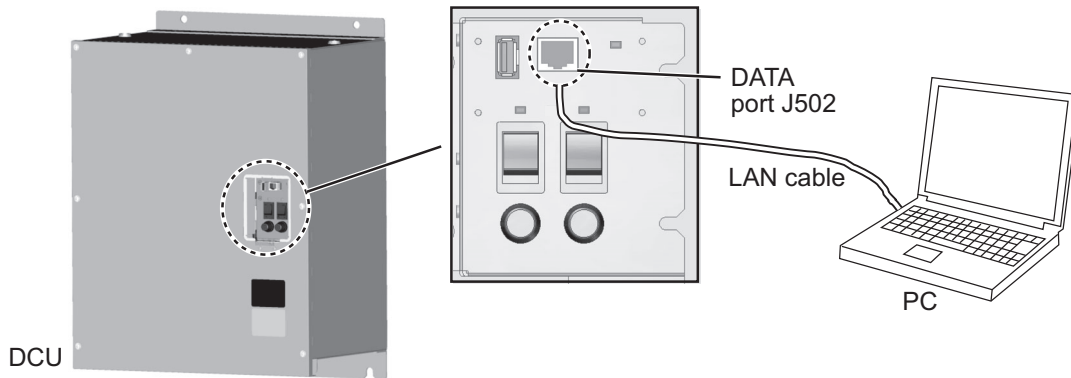

3. Open the [Tool] menu and select [Source Select].
4. Select [Long Term Device (LAN)] from the menu.
5. Click the [Analyze Track] button.
6. Click the [Connect] button.
7. Select [Extract] from the [Tool] menu to show the [Extraction] dialog box.
8. Activate the [Track Selection] radio button, then check the track you want to extract.
9. Click the [Select] button and select the location where to save data.
10. Click the [Start] button.
11. After the extraction\* is completed, click [OK], [Close] and [Close] in that order. Then, disconnect the cable between the PC and J502 in the DCU.

\*: The time required for the extraction depends on the VDR environment and specifications of the PC to be extracted. See the table below.

Amount of extraction data	Time required for extraction	File size on the PC
1 hour	1 to 2.5 minutes	300 to 900 MB
12 hours	15 to 22 minutes	3.5 to 8 GB



# 3. TROUBLESHOOTING

This chapter provides information on possible causes of problems you may experience with your VDR. If you still have a problem after referring to the table, contact your dealer for further advice. Always provide the product serial number.

## 3.1 General Troubleshooting

Use the table below to identify the problem, cause and remedy.

Problem	Cause	Remedy
AC LED does not light.	No power from the ship's mains.	Check the breaker switches on ship's mains switchboard.
BATTERY LED does not light.	The battery voltage is low or no power from the battery.	Contact your dealer.
BATTERY LED flashes.	During charging of the battery	Keep turning on the AC power until finishing the battery charge. The battery charge may takes approx. six hours.
SYSTEM FAILED LED lights in red.	System malfunction	The alert number for each alert appears in the alert list on the RAP. For each alert's remedy, see section 3.2.

## 3.2 Alert Numbers

Below is a list of alert numbers that appear in the alert list on the RAP (see paragraph 1.3.4). Only no. 412439 alert "Fatal System Error" corresponds to warning priority and all other alerts to caution priority.

Alert no.	Alert name	Description	Action
412026	GPS Large Time Difference	This indicates that the time difference between the system time of the DCU and the UTC time supplied by a GPS receiver is more than 10 seconds.	Restart the DCU with the GPS receiver connected. If the error re-occurs, contact your dealer.
412082	No RAP Connection (No DCU Connection)	DCU: RAP is missing. Connection to RAP is lost. RAP: DCU is missing. Connection to DCU is lost.	Restart the DCU. If the error re-occurs, contact your dealer.
412083	No AMS1 Connection	AMS1 is missing. Connection to AMS1 is lost.	Check cable connected to AMS1. Reconnect AMS1.
412085	No AMS2 Connection	AMS2 is missing. Connection to AMS2 is lost.	Check cable connected to AMS2. Reconnect AMS2.
412088	No JB Connection	Indicates that Junction Box (IF-8530) is missing.	Check cable connected to Junction Box. Reconnect Junction Box. If the error re-occurs, contact your dealer.
412170	VDR Configuration Failure	Data cannot be stored because of abnormal VDR configuration.	Restore VDR config data. If the error re-occurs, contact your dealer.

### 3. TROUBLESHOOTING

Alert no.	Alert name	Description	Action
412171	Recording Buffer Overflow	A image exceeding a recording buffer is input.	Contact your dealer.
412173	Fatal System Failure	Fatal system error. Reboot automatically after an error occurred.	If the error re-occurs, contact your dealer.
412175	LongTermDevice is stopped from recovering	The data cannot be recorded to the long term device more than ten minutes.	Restart VDR. If the error re-occurs, contact your dealer.
412176	FixedDRU is stopped from recovering	The data cannot be recorded to the Fixed DRU more than ten minutes.	
412177	FloatDRU is stopped from recovering	The data cannot be recorded to the Float-free DRU more than ten minutes.	Confirm that the capsule is seated in the bracket correctly, then restart VDR. If the error re-occurs, contact your dealer.
412181	FixedDRU Setting Defect	Fixed DRU information is read, even though settings are not complete.	Contact your dealer.
412182	FloatDRU Setting Defect	Float DRU information is read, even though settings are not complete.	
412185	SAVE Setting Difference	SAVE function settings differ between VDR and RAP.	Confirm VDR and RAP settings.
412186	RAP Version is old	RAP/mod.tgz program version is not compatible with the DCU program version.	Contact your dealer.
412187	Module Version is old		
412214	Running on batteries	AC power is down and the battery is running.	Reconnect AC power.
412218	MIC Test Failure	This alert is issued when the microphone test fails. The microphone test is run every 12 hours during normal operation.	Contact your dealer.
412234	No GPS Connection	System has not received UTC information.	Check that a valid UTC source (GPS receiver) is connected to the serial port. If the error re-occurs, contact your dealer.
412246	PDU Failure	The cable between PDU and CPU block is not connected.	Contact your dealer.
412254	Self Test Failure	System failed by the self test.	
4123xx (xx: 01 - 16)	No No.xx Serial Connection (xx: 01 - 16)	No. xx serial channel has not received correct format data from a connected serial device (xx: 01 - 16).	Check the sentences input from the serial channel on the RAP and confirm that the applicable sensor is operating correctly. If OK, contact your dealer.
4123xx (xx: 17 - 80)	No No.xx Sensor (LAN) Connection (xx: 01 - 64)	No. xx sensor (LAN) channel has not received correct format data from a connected sensor (LAN) device (xx: 01 - 64).	Check the sentences input from the LAN channel on the RAP and confirm that the applicable sensor is operating correctly. If OK, contact your dealer.

Alert no.	Alert name	Description	Action
412401	No Battery Connection or Low Battery Voltage	No battery input or voltage is too low.	Confirm that the battery switch is turned on. If ON, recharge or replace the battery.
412431	Serial Buffer Overflow	Serial data from DCU serial channel (1 - 8 ch) are not recorded to Fixed DRU, Float-free DRU and Long Term Device.	Restart VDR. If the error re-occurs, contact your dealer.
412432	JB Buffer Overflow	Serial, analog and digital data from Junction Box (IF-8530) are not recorded to Fixed DRU, Float-free DRU and Long Term Device.	
412437	Fatal System Failure	Fatal system error. This indicates that VDR can not be re-booted automatically.	
412438	System Information Error (VDR System Information Error)	VDR system information can not be acquired. Usually, this error is recovered automatically.	If error is not recovered automatically, restart VDR. If it does not recover, contact your dealer.
412439	Fatal System Error	Temperature of CPU system high and long term device is turned off.	Restart VDR. If the error re-occurs, contact your dealer.
412451	High CPU Core Temperature	Temperature of CPU core is high.	
412452	High CPU System Temperature (CPU Board System Temperature High)	Temperature of CPU board is high.	
412453	CPU +3.3V Voltage Error (CPU Board +3.3V Voltage Error)	Voltage error on CPU board. (+3.3 V line)	
412454	CPU +5V Voltage Error (CPU Board +5V Voltage Error)	Voltage error on CPU board. (+5 V line)	
412455	CPU +12V Voltage Error (CPU Board +12V Voltage Error)	Voltage error on CPU board. (+12 V line)	
412456	CPU VCORE Voltage Error (CPU Board VCORE Voltage Error)	Voltage error on CPU board. (VCORE line)	
412457	Low CPU Battery Voltage (CPU Board Battery Voltage Lower)	Voltage of battery on CPU board is low.	
412458	Low CPU FAN Rotation Speed	Rotation speed of CPU FAN is low.	
412459	CPU FAN Not Rotated	CPU FAN stopped.	

### 3. TROUBLESHOOTING

Alert no.	Alert name	Description	Action
412460	Low External FAN1 Rotation Speed	Rotation speed of external FAN1 is low.	Restart VDR. If the error re-occurs, contact your dealer.
412461	External FAN1 Not Rotated	External FAN1 stopped.	
412462	Low External FAN2 Rotation Speed	Rotation speed of external FAN2 is low.	
412463	External FAN2 Not Rotated	External FAN2 stopped.	
412501	No FixedDRU Connection	Fixed DRU has been disconnected more than 600 seconds.	Check the connection with the Fixed DRU. If OK, contact your dealer.
412502	No FloatDRU Connection	Float-free DRU has been disconnected more than 600 seconds.	Check that the capsule is seated in the bracket correctly. If OK, contact your dealer.
412503	No LongTermDevice Connection	Long Term Device has been disconnected more than 600 seconds.	Contact your dealer.
412504	No UserDisk Connection	UserDisk has been disconnected more than 600 seconds.	
412511	FixedDRU Recording Failure	Fixed DRU is unable to write.	Check the connection with the Fixed DRU. If OK, contact your dealer.
412512	FloatDRU Recording Failure	Float-free DRU is unable to write.	Check that the capsule is seated in the bracket correctly. If OK, contact your dealer.
412513	LongTermDevice Recording Failure	Long Term Device is unable to write.	Restart the VDR.
412514	UserDisk Recording Failure	UserDisk is unable to write.	
412515	FixedDRU Exchanged	Fixed DRU is replaced.	
412516	FloatDRU Exchanged	Float-free DRU is replaced.	
412517	LongTermDevice Exchanged	Long Term Device is replaced.	
412518	No.1 LongTermDevice Error	No.1 Long Term Device is error.	
412519	No.2 LongTermDevice Error	No.2 Long Term Device is error.	
412521	FixedDRU Memory Shortage	Data cannot be recorded more than 48 hours.	Contact your dealer.
412522	FloatDRU Memory Shortage	Data cannot be recorded more than 48 hours.	
412523	LongTermDevice Memory Shortage	<ul style="list-style-type: none"> <li>VR-7000: Data cannot be recorded more than "720 hours + used hours in SAVE areas".</li> <li>VR-7000S: Data cannot be recorded more than "48 hours + used hours in SAVE areas".</li> </ul>	
412524	UserDisk Memory Shortage	Data cannot be recorded more than setting hours.	

Alert no.	Alert name	Description	Action
412525	Sensor(LAN) Buffer Overflow	Serial, analog and digital data from Sensor Adapter are not recorded to Fixed DRU, Float-free DRU and Long Term Device.	If the error re-occurs, contact your dealer.
412527	Image(LAN) Buffer Overflow	Image data from RADAR/ECDIS are not recorded to Fixed DRU, Float-free DRU and Long Term Device.	
41253x (x: 1 - 8)	No No.x Sensor Adapter Connection (x: 1 - 8)	No. x Sensor Adapter is missing (x: 1 - 8).	Contact your dealer.
412541	No No.1 VIDEO LAN Converter Connection	No.1 VIDEO LAN Converter is missing.	
412542	No No.2 VIDEO LAN Converter Connection	No.2 VIDEO LAN Converter is missing.	
412545	No Audio IF Board Connection	Audio IF Board is missing.	
41255x (x: 1 - 4)	No No.x Radar Input Image (x: 1 - 4)	No.x Radar has been powered off and the image data is not received (x: 1 - 4).	Turn on the No. x Radar (x: 1 - 4). If the error re-occurs, contact your dealer.
41255x (x: 5 - 7)	No No. x ECDIS Input Image (x: 1-3)	No.x ECDIS has been powered off and the image data is not received (x: 1 - 3).	Turn on the No. x ECDIS (x: 1 - 3). If the error re-occurs, contact your dealer.
41258x (x: 1 - 3)	No No.x ECDIS Attached information Input (No.1 - No.3)	No.x ECDIS has been powered off and the attached information is not received (x: 1 - 3).	
412601	No Radar1 Recording Image Input	Image input channel that is not valid for No.1 Radar setting is set.	Turn on the No. 1 or No. 2 Radar. If the error re-occurs, contact your dealer.
412602	No Radar2 Recording Image Input	Image input channel that is not valid for No.2 Radar setting is set.	
412603	No ECDIS Recording Image Input	Image input channel that is not valid for ECDIS setting is set.	Turn on the ECDIS. If the error re-occurs, contact your dealer.
412604	No Additional Recording Image Input	Image input channel that is not valid for Additional setting is set.	Turn on the additional units. If the error re-occurs, contact your dealer.
412605	No General1 Recording Image Input	Image input channel that is not valid for No.1 General setting is set.	Turn on the No. 1 or No. 2 General. If the error re-occurs, contact your dealer.
412606	No General2 Recording Image Input	Image input channel that is not valid for No.2 General setting is set.	
41261x (x: 1-4)	No. x Radar Unrecognized Image (x: 1 - 4)	VDR does not support the format of image data from No. x Radar (x: 1 - 4).	Contact your dealer.
41261x (x: 5-7)	No.* ECDIS Unrecognized Image (x: 1 - 3)	VDR does not support the format of image data from No. x ECDIS (x: 1 - 3)	

### 3. TROUBLESHOOTING

<b>Alert no.</b>	<b>Alert name</b>	<b>Description</b>	<b>Action</b>
4128xx (xx: 01 - 16)	No yy (yy: Equipment name)	No. xx serial channel has not received correct format data from a connected serial device (xx: 01 - 16).	Check the equipment name on the RAP and confirm that the applicable sensor is operating correctly. If the sensor is operating correctly, contact your dealer.
4128xx (xx: 17 - 80)	No yy (yy: Equipment name)	No. xx sensor (LAN) channel has not received correct format data from a connected sensor (LAN) device (xx: 01 - 64).	
412901	Liveplay Not Available	The live play is not available because the remote playback function is activated.	Deactivate the remote playback function to use the live play function.

# 4. REMOTE PLAYBACK FUNCTION (LAND-SHIP COMMUNICATION)

---

You can replay or extract the data from the PC on the shore by connecting the PC to the on-board VDR through the satellite link.

Operate the Live Player V5 to use the remote playback function. For how to use the remote playback function, see the Live Player V5 operator's manual (OME-44851).

This chapter explains the preparation and limitations about the remote playback function, and recommended network configuration.

## 4.1 Preparations

The following preparations are required to connect an on-shore PC to the on-board VDR:

- The land-ship connection through a satellite link (ex. VSAT) must be established by VPN connection. Check the communication between the on-shore PC and on-board VDR, by sending a Ping request to the specified IP address.
- Configure the firewall to allow access to all network ports used for the land-ship communication. This setting must be applied to all network devices. For the network ports used by the VDR and Live Player V5, consult your dealer.
- The VDR must be configured to activate the remote playback function. Contact your dealer to activate the remote playback function.
- When you want to connect the PC multiple VDRs, a unique IP address is required for each VDR.
- The remote playback function uses UDP communication. Therefore, it is recommended that the router on the communication path is compatible with the Path MTU Discovery function.
- It is recommended to use a fixed charge satellite line for the remote playback function. If you use a satellite line with a meter-rate system, communication cost may become expensive.

## 4.2 Limitations and Notifications

Keep in mind the following limitations and notifications to use the remote playback function.

- Both of the DCU and Live Player V5 program versions must be "01.30" or later.
- The following functions are available by using the remote playback function:
  - Remote live play ([Live (Remote)])
  - Data extraction by LAN connection ([Long Term Device (LAN)] or [Long Term Device (Save Area)])
- The remote replay function is not available when the on-board PC (Live Player V5) is connecting to the VDR by LAN connection or RAP is extracting the data.

#### 4. REMOTE PLAYBACK FUNCTION (LAND-SHIP COMMUNICATION)

- The following communication environment is recommended to use the remote playback function:
  - Average baud rate: 80 kbps or higher
  - Packet loss rate: Less than 5%
  - Average communication delay: Less than 1200 msec
- When you establish a VPN connection from the shore, the network segment on the shore must be different from the VDR network segment. VDR network segment is as follows:
  - 10.0.0.xxx/255.255.255.0: Change the VDR subnet address.
  - 172.31.xxx.xxx/255.255.0.0
  - 192.168.31.xxx/255.255.255.0: Used only for applicable vessels.

### 4.3 Recommended Network Construction

The following figure shows the recommended network construction for remote playback functions:

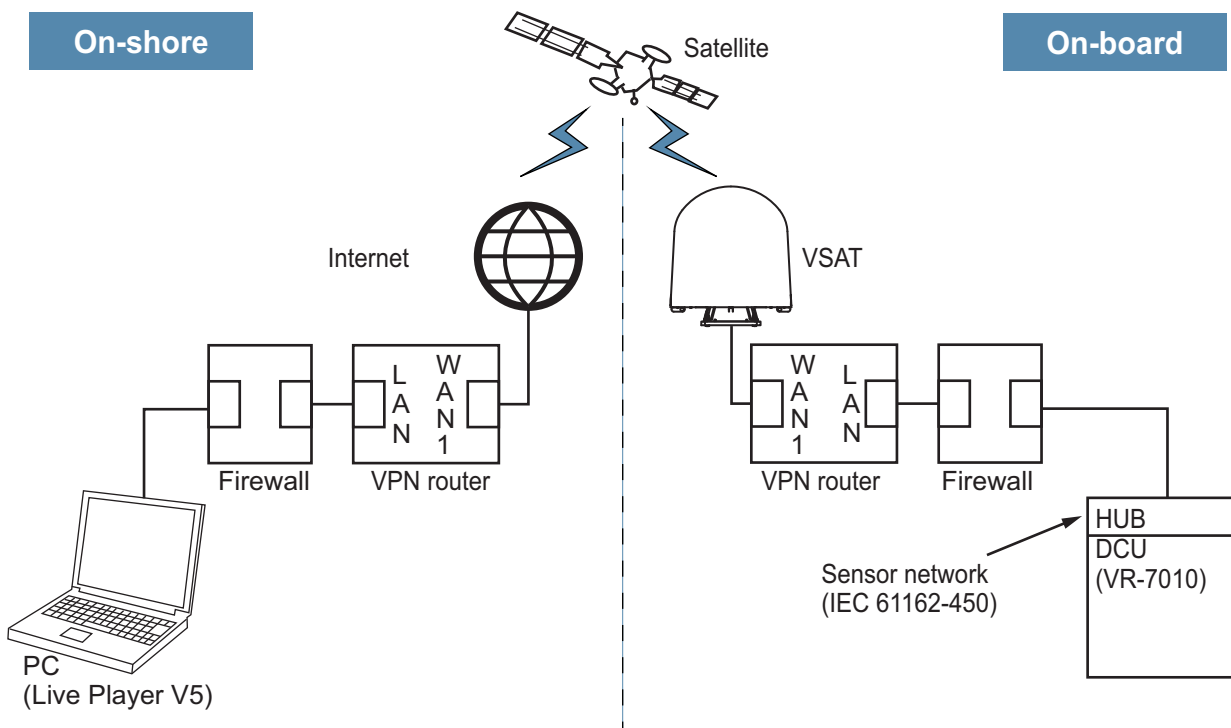

*IP address setting examples*

On-shore	
VPN Router WAN1	Fixed global IP address is recommended.
VPN Router LAN	192.168.5.1/255.255.255.0
PC	192.168.5.101/255.255.255.0 Default gateway: 192.168.5.1
On-board	
VPN Router WAN1	Fixed global IP address is recommended.
VPN Router LAN	192.168.6.1/255.255.255.0
DCU (VR-7010)	No.2 IP address for IEC 61162-450 network: 192.168.6.101/255.255.255.0 Default gateway: 192.168.6.1

**Note:** The IP addresses on the table above are only one example.



# APPENDIX 1 MENU ITEMS

---

Below are the menu items for the Remote Alarm Panel (RAP). To open this menu, press the **MENU/ESC** key.

Menu item	Function
Execute SAVE Function (only for VR-7000S)	Records the data, which are recorded to the capsule, to area1 (or 2, 3, 4) in the long term device(s)
Serial Monitor	Displays the sensor information input to the serial channels on the Serial Monitor screen.
Sensor(LAN) Monitor	Displays the sensor information input to the LAN channels on the Sensor (LAN) Monitor screen.
Analog Monitor	Displays the sensor information input to the analog channels on the Analog Monitor screen.
Digital Monitor	Displays the sensor information input to the digital channels on the Digital Monitor screen.
Image Capture Status	Displays the information of the images recorded in the DCU on the Image Capture Status screen.
Audio Monitor	Displays the status of the microphones and communications equipment (VHF, etc.) on the Audio Monitor screen.
Life Parts List	Displays the lifetimes of the parts on the Life Parts List screen.
Status Monitor	Displays the status of the system on the Status Monitor screen.
Settings	<ul style="list-style-type: none"><li>• Key Beep: Turns key beep on or off. (ON, OFF)</li><li>• [Brilliance Sync]: Turn the brilliance sharing function on or off. (ON, OFF)</li><li>• [Brilliance Sync Settings]: Adjust the preset setting value for the brilliance sharing.</li><li>• Serviceman Settings: No use.</li></ul>

# APPENDIX 2 PARTS LIST/LOCATION

## Parts list

This equipment contains complex modules in which fault diagnosis and repair down to component level are not practical (IMO A.694(17)/8.3.1). Only some discrete components are used. FURUNO Electric Co., Ltd. believes identifying these components is of no value for shipboard maintenance; therefore, they are not listed in this manual. Major modules can be located on the parts location photos on the next page.

<b>ELECTRICAL PARTS LIST</b>	Unit	Data Collecting Unit VR-7010
<b>Code No.</b>		
<b>PRINTED CIRCUIT BOARD</b>		
ADP-586-31/ADP-216-01, CPU		—
24P0135, PDU		—
24P0137, HUB		—
24P0137A, HUB		—
24P0133, TB		—
24P0141, FIL		—
24P0138, LED		—
24P0134, AUDIO		—

<b>ELECTRICAL PARTS LIST</b>	Unit	Video LAN Converter IF-7100
<b>Code No.</b>		
<b>PRINTED CIRCUIT BOARD</b>		
24P0132, VLC		—

<b>ELECTRICAL PARTS LIST</b>	Unit	Remote Alarm Panel VR-7017
<b>Code No.</b>		
<b>PRINTED CIRCUIT BOARD</b>		
24P0139, PWR		—
20P8200C, MAIN		—

<b>ELECTRICAL PARTS LIST</b>	Unit	Microphone VR-7011
		Waterproof Microphone VR-7012W
<b>Code No.</b>		
<b>PRINTED CIRCUIT BOARD</b>		
24P0136, MIC		—

<b>ELECTRICAL PARTS LIST</b>	Unit	Sensor Adapter MC-3000S
<b>Code No.</b>		
<b>PRINTED CIRCUIT BOARD</b>		
24P0114, MC-CS		—

Parts location

**Data Collecting Unit (VR-7010)**

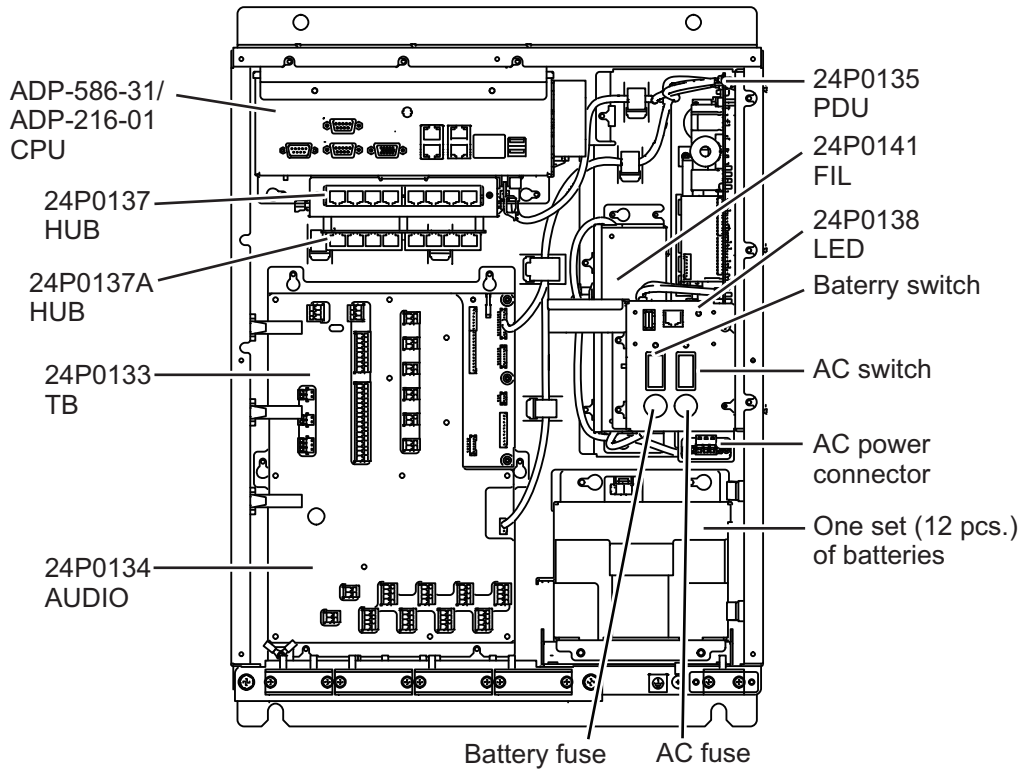

**Video LAN Converter (IF-7100)**

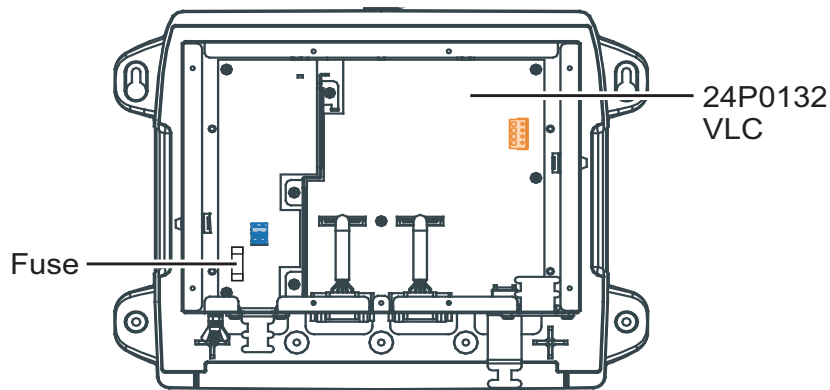

**Remote Alarm Panel (VR-7017)**

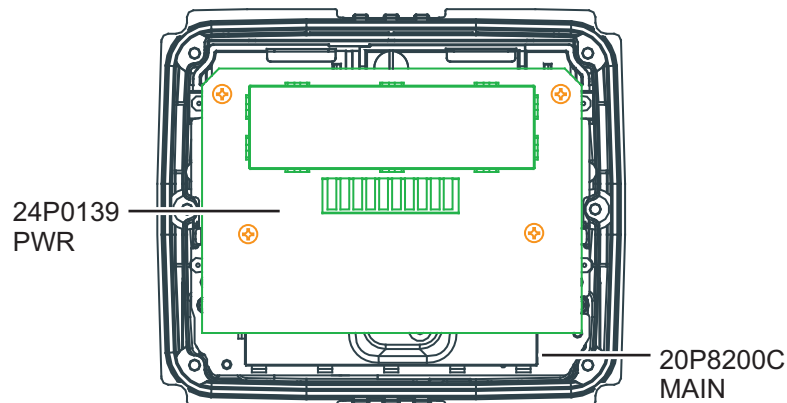

**Microphone (VR-7011), Waterproof Microphone (VR-7012W)**

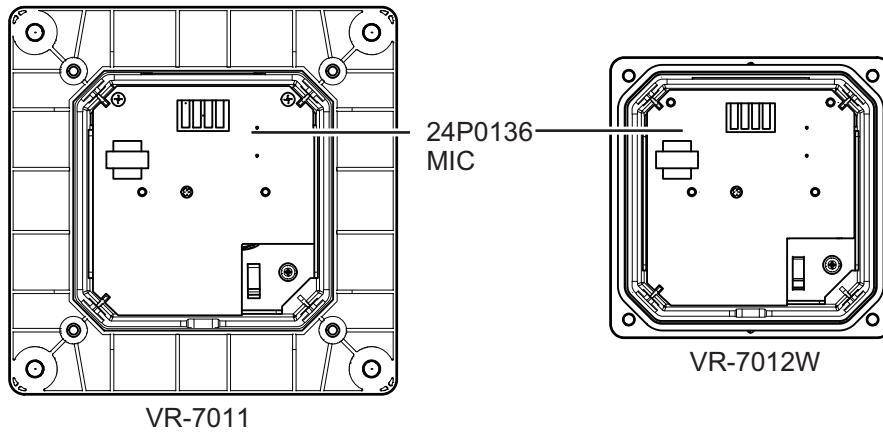

**Sensor Adapter (MC-3000S)**

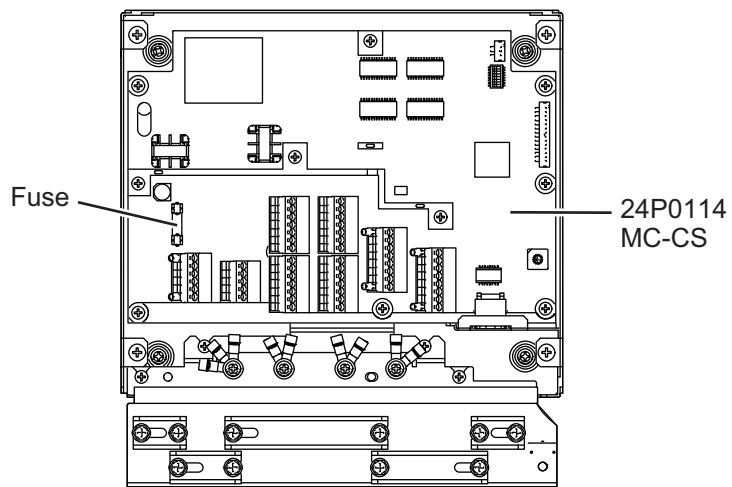



# APPENDIX 3 LIST OF TERMS AND ABBREVIATIONS/SYMBOLS

The following table shows the terms, abbreviations and symbols used in the VR-7000/7000S.

## Terms and abbreviations

Term	Abbreviation	Term	Abbreviation
Alternate current	AC	Local Area Network	LAN
Additional	ADD	Liquid Crystal Display	LCD
Alert	ALERT	Light Emitting Diode	LED
Alarm Management System	AMS	LAN	LN
Analog Channel	AN	Main	MAIN
Audio	AUDIO	Menu	MENU
Brilliance	BRILL	Microphone	MIC
Complementary Metal-Oxide Semiconductor	CMOS	Power Distribution Unit	PDU
Central Processing Unit	CPU	Power	PWR
Digital Channel	DC	Radar	RADAR
Data Collecting Unit	DCU	Random Access Memory	RAM
Difference	DIFF	Remote Alarm Panel	RAP
Data Recording Unit	DRU	Read Only Memory	ROM
Electronic Chart Display and Information System	ECDIS	Serial	SI
Enter	ENT	Solid State Drive	SSD
Emergency Position-Indicating Radio Beacon	EPIRB	System	SYS
Escape	ESC	Terminal	TERMINAL
Fan	FAN	Universal Serial Bus	USB
Filter	FIL	Universal Time Coordinated	UTC
Global Positioning System	GPS	Voltage of Core	VCORE
Hub	HUB	Voyage Data Recorder	VDR
Identification	ID	Very High Frequency	VHF
Interface	IF	Video	VIDEO
Junction Box	JB	Video LAN Converter	VLC

## Symbols

Symbols	Meaning
	Active unacknowledged warning (A flashing yellowish orange circle)
	Active acknowledged warning (A yellowish orange circle)
	Caution (A yellow square)

# APPENDIX 4 PLAYING BACK RECORDED DATA

---

IMO Circular MSC.214(81) recommends that all VDR systems installed on or after 1 June 2008 carry software to playback data on a PC, the manual for data extraction, and the cable necessary to connect the PC to the Data Collecting Unit (DCU). Attach the supplied card holder to the front door of the DCU to store the items listed in the table below.

### *Items to store in the card holder*

Name	Type	Code No.	Remarks
CD-ROM (For Live Player)	VR-7030 SW&MANUAL CD	000-191-754	With Accessories FP24-01110
Data Extraction Procedure	E42-01402	000-179-354	
LAN Cable Assembly	MOD-Z072-020+	001-167-880-10	

See the data extraction procedure for how to play back data.

### How to attach the card holder

Use the supplied accessories to attach the card holder to the DCU.

Remove the paper from the double-sided tape on the card holder. Attach the card holder to the location in the DCU shown below.

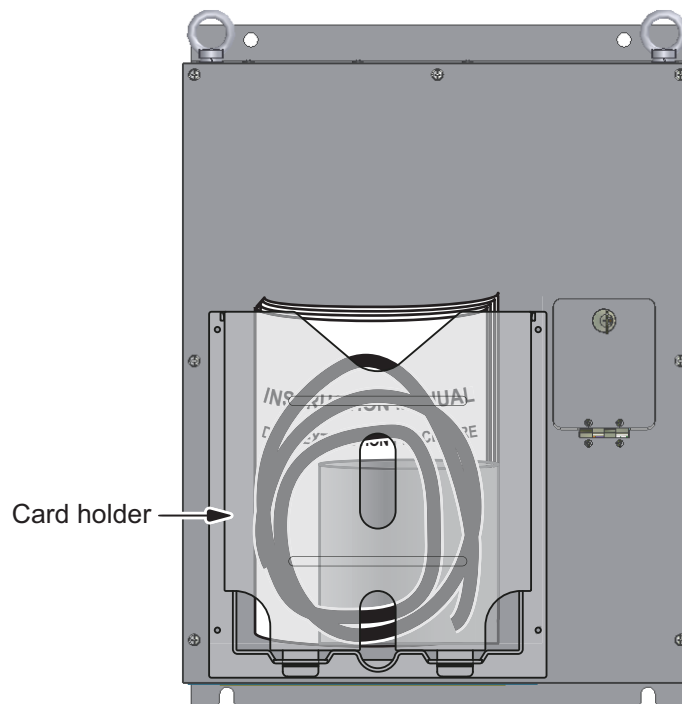

**SPECIFICATIONS OF  
VOYAGE DATA RECORDER VR-7000  
SIMPLIFIED VOYAGE DATA RECORDER VR-7000S**

The Voyage Data Recorder (VDR) is a recording system required on certain categories of ships from 1st July 2002 by the revised SOLAS Chapter V. VR-7000/7000S fully complies with the IMO Resolution MSC.333 (90) and IEC 61996-1/2 testing standard.

**1 GENERAL**

- 1.1 Recording period
  - Data recording unit 48 hrs (Fixed DRU or Float-free DRU selected for VR-7000S)
  - Long term device (long-term recording medium) 720 hrs
- 1.2 Battery backup More than two hours after loss of ship's mains

**2 DATA COLLECTING UNIT (DCU)**

- 2.1 CPU Board ( either one)
  - ADP-586-31 Intel Celeron P4505 1.86 GHz
  - ADP-216-01 Intel Atom x5-E3940 1.6 GHz
- 2.2 Long term device
  - Memory capacity 512 GB or 1 TB (SSD)
  - Minimum data retention period 2 years after recording

**3 REMOTE ALARM PANEL**

- 3.1 Display 4.3-inch color LCD, 480 x 272 (WQVGA)
- 3.2 Picture color 256 colors
- 3.3 Brilliance 0.2 to 700 cd/m<sup>2</sup>
- 3.4 Visible distance 0.5 m nominal

**4 DATA RECORDING UNIT (DRU)**

- 4.1 Fixed DRU
  - Chassis Protective capsule (metal)
  - Memory capacity 32 GB
  - Minimum data retention period 2 years after recording
  - Shock resistance 50G x 11 ms
  - Penetration resistance 100mm diameter pin with 250 kg weight, dropped from 3 m height
  - Fire resistant 1100°C for 1 hour, 260°C for 10 hours
  - Submersible 6000 m (60MPa)
  - Acoustic beacon Battery life: 3 years from the date of insertion,  
37.5kHz, 10ms pulse transmission,  
Maximum depth: 6000m  
Operating life: 90 days
- 4.2 Float-free DRU
  - Chassis Auto-float capsule
  - Memory capacity 64 GB
  - Minimum data retention period 6 months after recording
  - Battery Lithium, Metal, 7.2 V/ 18 Ah (2S5P),

	5 year's service life (6.5 years from the date of manufacture)
Operating life	Minimum 168 hrs at -20°C
Release mechanism	Hydrostatic release unit (released at water depth 4 m)
Navigation device	22 channel GPS receiver
<b>COSPAS-SARSAT Transmitter</b>	
Antenna type	Built-in, omnidirectional
Frequency	406.037 MHz ± 2 ppm
Output power	5 W ± 2 dB
Protocols	MMSI and Serial Location Protocols
Modulation	Phase modulation 1.1 ± 1 radian
Data encoding	Bi-phase L
Bit rate	400 bps
<b>Homing Transmitter</b>	
Frequency	121.5 MHz
Output power	50 mW ± 3 dB
Modulation	A3X, AM sweep tone between 300 Hz and 1600 Hz
Sweep range	700 Hz (sweep rate: 2.5 Hz)
Stability	10 ppm over temperature

## 5 MICROPHONE

5.1	Reference signal level	0 dBm/600 ohm at 91 dBA
5.2	Frequency response	Within 12 dB at 150Hz to 6 kHz
5.3	Audio coverage	Hemisphere area of 3.5 m approx. in radius
5.4	Test beeper	3s in 12 hours period (built in)

## 6 HUB (OPTION)

6.1 Switching HUB (HUB-100)	
Number of ports	8 ports (10Base-T/100Base-TX), Auto-MDI/MDI-X compliant
Switching Method	Store and forward
Buffer memory	SRAM
6.2 Intelligent HUB (HUB-3000)	
Number of ports	8 ports (10/100/1000Base-T) , Auto-MDI/MDI-X compliant
Switching Method	Store and forward, non-blocking L2 switching
Capacitance of switching	16 Gbps
VLAN	Port-base VLAN, IEEE802.1Q Tag VLAN supported
Multiple VLAN	Communication between isolated ports is disabled

## 7 INTERFACE

7.1 Data collecting unit	
Number of port	
LAN	6 ports, Ethernet 100Base-TX, RJ45 connector 5 ports for IEC61162-450: IP address range 172.31.16.1-254, 172.31.17.1-254, default 172.31.16.200 1 port for internal: IP address 10.0.0.100 2 ports for Live Player or Data transmission (ADP-216-01 only)



- Bridge audio (input) 8 ch (0 dBm/600 ohm)
- VHF audio (input) 2 ch (0 dBm/600 ohm)
- Serial IEC61162-1/2: 2 ports, IEC61162-1: 6 ports
- Serial I/O for AMS IEC61162-1: 1 ch
- USB 1 port, USB2.0 for data extraction, User disk recording
- Alarm (output) 3 ch, contact signal, load current 30 mA  
System fail, Power fail, Local ACK
- Remote ACK (input) 1 ch
- Buzzer stop (input) 1 ch
- IEC61162-450 transmission group
  - Input MISC, SATD, NAVD, VDRD, RCOM, TIME, PROP, USR1 to USR8
  - Output MISC
- Other Network Function (except IEC61162-450)
  - HTTP; \*.\*.\*:80
  - VR-7000 replies on PC's ARP command and ping command
  - Live player, Maintenance viewer
  - UDP multicast: 239.255.0.1  
Port: 20001-20004, 21001-21004, 22001-22007, 23001-23007  
27001-27010, 28001-28010
  - TCP: \*.\*.\*, Port: 20, 21, 10106, 24001, 24004
- I/O Sentences
  - Input All incoming
  - Output ALC, ALF, HBT

## 7.2 Sensor adapter

- MC-3000S (serial) 8 ports: I/O, IEC61162-1/2: 4 ports, IEC61162-1: 4 ports
- MC-3010A (analog, option) 3 ports: Input, -10 to +10V, 0 to 10V or 4 to 20 mA
- MC-3020D (digital-in, option) 8 ports: relay contact, logics set from program

## 7.3 Video signal input

- Video LAN converter 2 ch (DVI/RGB selectable for each)  
SER.NO. 100000 to 199999: RGB is not available
- RGB VESA: VGA, SVGA, XGA, SXGA, UXGA (FAR-28x7/28x5 ser.)
- DVI VESA: VGA to SXGA, WXGA+\*, UXGA, WUXGA,  
CEA: Full HD (FAR-28x7 ser.)  
\*: FPGA program ver.01.03 or later and  
SER. NO. 200991 or later for IF-7100
- IEC 61162-450 For PNG (24 bit, recording data compressed to JPEG: 32 or 48 bit, index color) or JPEG (baseline: SOF0, progressive: SOF2)

Number of channels for picture recording

Device	Video LAN converter IEC61162-450 PNG	IEC61162-450 JPEG	
		Quality ≥ 50	Quality < 50
Fixed/ float-free DRU or long term device (single)	UXGA: 2ch + full-HD: 1ch, Total 3ch	3ch	5ch
Long term device (dual)	UXGA: 2ch + full-HD: 1ch + WUXGA: 1ch, Total 4ch	4ch	6ch

Picture recording pattern Selectable for each channel (Only one/Patrol/Backup)

## 8 POWER SUPPLY

- 8.1 Data collecting unit 100-230 VAC: 1.6-0.7 A, 1 phase, 50/60 Hz
- 8.2 Sensor adapters 24 VDC: 1.4 A max.(11 units), fed from DCU
- 8.3 Video LAN converter (IF-7100, option) 24 VDC: 0.3 A (SER.NO. 100000 to 199999: 0.7 A)
- 8.4 HUB (option)
  - HUB-3000 100-230 VAC: 0.1 A, 1 phase, 50-60 Hz
  - HUB-100 100-230 VAC: 0.1 A, 1 phase, 50-60 Hz

## 9 ENVIRONMENTAL CONDITIONS

- 9.1 Ambient temperature
  - Data collecting unit -15°C to +55°C
  - Fixed DRU -25°C to +55°C
  - Float-free DRU -20°C to +55°C
  - Waterproof microphone -25°C to +55°C
  - Others -15°C to +55°C
- 9.2 Relative humidity 93% or less at +40°C
- 9.3 Degree of protection
  - Data collecting unit IP20
  - Fixed DRU IP56 equivalent
  - Float-free DRU IP67 equivalent
  - Remote alarm panel IP22 (front panel), IP20 (chassis)
  - Sensor adapter IP20 (IP22: option)
  - Junction box IP20 (IF-8540), IP56 (VR-7022F)
  - Video LAN converter IP22
  - Microphone IP22 (panel), IP20 (chassis)
  - Waterproof microphone IP56
  - HUB-3000 IP20 (IP22: option)
  - HUB-100 IPX0
- 9.4 Vibration IEC 60945 Ed.4

## 10 UNIT COLOR

- 10.1 Data collecting unit N2.5 (standard)
- 10.2 Fixed DRU Fluorescent orange (fixed)
- 10.3 Float-free DRU Fluorescent orange (chassis), White (bracket)
- 10.4 Remote alarm panel/ Video LAN converter/ Sensor adapter  
N2.5
- 10.5 Junction box N2.5 (IF-8540), 7.5BG7/2 (VR-7022F)
- 10.6 Microphone/ Waterproof microphone N2.5 (fixed)
- 10.7 HUB N2.5 (HUB-3000), N3.0 (HUB-100)

## Declaration of Conformity



# 0560

We **FURUNO ELECTRIC CO., LTD.**

(Manufacturer)

9-52 Ashihara-Cho, Nishinomiya City, 662-8580, Hyogo, Japan

(Address)

declare under our sole responsibility that the product

**VOYAGE DATA RECORDER VR-7000**  
(Serial No.1000-19xx-xxxx)

(Model name, type number)

to which this declaration relates conforms to the following standard(s) or normative document(s)

IMO Resolution A.694(17)	IEC 61996-1 Ed.2.0: 2013 incl. Corr. 1, 2014
IMO Resolution MSC.36(63)	IEC 61162-1 Ed.5.0: 2016
IMO Resolution MSC.97(73)	IEC 61162-2 Ed.1.0: 1998
IMO Resolution MSC.191(79)	IEC 61162-450 Ed.1.0 A1: 2016
IMO Resolution MSC.302(87)	IEC 62288 Ed.2.0: 2014
IMO Resolution MSC.333(90)	IEC 60945 Ed.4.0: 2002 incl. Corr. 1, 2008
	IEC 61924-2 Ed.1.0: 2012 Annex K and M

(title and/or number and date of issue of the standard(s) or other normative document(s))

For assessment, see

- EC type examination (Module B) certificate No. MEDB000039E Rev.2 issued by DNV GL AS (0575), Norway.
- Product Quality System (Module D) certificate No. P 112 (Issue 46) issued by Telefication, The Netherlands.

This declaration is issued according to the Directive 2014/90/EU of the European Parliament and of the Council on marine equipment, and the Implementing Regulation (EU) 2020/1170.

On behalf of Furuno Electric Co., Ltd.

Nishinomiya City, Japan  
October 30, 2020

(Place and date of issue)

Akihiko Kanechika  
Department General Manager  
Quality Assurance Department

(name and signature or equivalent marking of authorized person)

## Declaration of Conformity



# 0560

We **FURUNO ELECTRIC CO., LTD.**

(Manufacturer)

9-52 Ashihara-Cho, Nishinomiya City, 662-8580, Hyogo, Japan

(Address)

declare under our sole responsibility that the product

**SIMPLIFIED VOYAGE DATA RECORDER VR-7000S**

(Serial No.1000-58xx-xxxx)

(Model name, type number)

to which this declaration relates conforms to the following standard(s) or normative document(s)

IMO Resolution A.694(17)	IEC 61996-1 Ed.2.0: 2013 incl. Corr. 1, 2014
IMO Resolution MSC.163(78)	IEC 61996-2 Ed.2.0: 2007
IMO Resolution MSC.191(79)	IEC 61162-1 Ed. 5.0: 2016
IMO Resolution MSC.302(87)	IEC 61162-2 Ed.1.0: 1998
	IEC 61162-450 Ed. 1.0 A1: 2016
	IEC 62288 Ed.2.0: 2014
	IEC 60945 Ed.4.0: 2002 incl. Corr. 1, 2008

(title and/or number and date of issue of the standard(s) or other normative document(s))

For assessment, see

- EC type examination (Module B) certificate No. MEDB00001MR Rev.4 issued by DNV GL AS (0575), Norway.
- Product Quality System (Module D) certificate No. P 112 (Issue 46) issued by Telefication, The Netherlands.

This declaration is issued according to the Directive 2014/90/EU of the European Parliament and of the Council on marine equipment, and the Implementing Regulation (EU) 2020/1170.

On behalf of Furuno Electric Co., Ltd.

Nishinomiya City, Japan  
October 30, 2020

(Place and date of issue)

Akihiko Kanechika  
Department General Manager  
Quality Assurance Department

(name and signature or equivalent marking of authorized person)







**ECF**

(Elemental Chlorine Free)

The paper used in this manual  
is elemental chlorine free.

**FURUNO ELECTRIC CO., LTD.**

9-52 Ashihara-cho,  
Nishinomiya, 662-8580, JAPAN

• FURUNO Authorized Distributor/Dealer

All rights reserved. Printed in Japan

Pub. No. OME-44850-M1

(REFU ) VR-7000/7000S

A : JUL. 2014

M1 : DEC. 14, 2020



0 0 0 1 9 7 2 0 4 1 1