

FURUNO

OPERATOR'S MANUAL

FISH FINDER
HI-RES FISH FINDER
FISH SIZE INDICATOR

FCV-1900

FCV-1900B

Model FCV-1900G

(Product Name: FISH FINDER)

 **FURUNO ELECTRIC CO., LTD.**



www.furuno.com

ECF

(Elemental Chlorine Free)

The paper used in this manual
is elemental chlorine free.

FURUNO ELECTRIC CO., LTD.

9-52 Ashihara-cho,
Nishinomiya, 662-8580, JAPAN

• FURUNO Authorized Distributor/Dealer

All rights reserved. Printed in Japan

Pub. No. OME-23860-G3

(TEHI) FCV-1900/1900B/1900G

A : APR. 2015

G3 : JUN. 01, 2021



0 0 0 1 9 0 5 0 0 1 6

IMPORTANT NOTICES

General

- This manual has been authored with simplified grammar, to meet the needs of international users.
- The operator of this equipment must read and follow the descriptions in this manual. Wrong operation or maintenance can cancel the warranty or cause injury.
- Do not copy any part of this manual without written permission from FURUNO.
- If this manual is lost or worn, contact your dealer about replacement.
- The contents of this manual and equipment specifications can change without notice.
- The example screens (or illustrations) shown in this manual can be different from the screens you see on your display. The screens you see depend on your system configuration and equipment settings.
- Save this manual for future reference.
- Any modification of the equipment (including software) by persons not authorized by FURUNO will cancel the warranty.
- The following concern acts as our importer in Europe, as defined in DECISION No 768/2008/EC.
 - Name: FURUNO EUROPE B.V.
 - Address: Ridderhaven 19B, 2984 BT Ridderkerk, The Netherlands
- The following concern acts as our importer in UK, as defined in SI 2016/1025 as amended SI 2019/470.
 - Name: FURUNO (UK) LTD.
 - Address: West Building Penner Road Havant Hampshire PO9 1QY, U.K.
- All brand and product names are trademarks, registered trademarks or service marks of their respective holders.

How to discard this product

Discard this product according to local regulations for the disposal of industrial waste. For disposal in the USA, see the homepage of the Electronics Industries Alliance (<http://www.eiae.org/>) for the correct method of disposal.

How to discard a used battery

Some FURUNO products have a battery(ies). To see if your product has a battery, see the chapter on Maintenance. If a battery is used, tape the + and - terminals of the battery before disposal to prevent fire, heat generation caused by short circuit.

In the European Union

The crossed-out trash can symbol indicates that all types of batteries must not be discarded in standard trash, or at a trash site. Take the used batteries to a battery collection site according to your national legislation and the Batteries Directive 2006/66/EU.

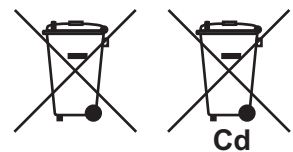

In the USA

The Mobius loop symbol (three chasing arrows) indicates that Ni-Cd and lead-acid rechargeable batteries must be recycled. Take the used batteries to a battery collection site according to local laws.

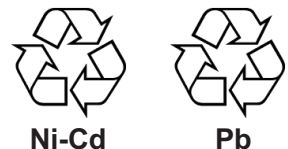

In the other countries

There are no international standards for the battery recycle symbol. The number of symbols can increase when the other countries make their own recycle symbols in the future.



SAFETY INSTRUCTIONS

The operator must read the applicable safety instructions before attempting to operate the equipment.



WARNING

Indicates a potentially hazardous situation which, if not avoided, could result in death or serious injury.



CAUTION

Indicates a potentially hazardous situation which, if not avoided, can result in minor or moderate injury.



Warning, Caution



Prohibitive Action



Mandatory Action



WARNING



ELECTRICAL SHOCK HAZARD
Do not open the equipment.

Hazardous voltage exists inside the equipment. Refer repair to authorized service personnel.



Immediately turn off the power at the switchboard if something is dropped into the equipment.

Continued use of the equipment can cause fire or electrical shock.



Immediately turn off the power at the switchboard if the equipment is emitting smoke or fire.

Continued use of the equipment can cause fire or electrical shock. Contact a FURUNO agent for service.



Use only the specified power and signal cable.

Fire or damage to the equipment can result if a different cable is used.



WARNING



Do not disassemble or modify the equipment.

Fire, electrical shock or injury can result.



Keep the equipment away from rain and water splash.

Fire, electrical shock or injury can result if water leaks into the equipment.



Do not put containers with liquids on the top of the equipment.

Fire, electrical shock or injury can result.





Do not operate the equipment with wet hands.





Electrical shock can result.



Use the proper fuse.



Use of an incorrect fuse can damage the equipment and can cause fire.

 CAUTION	
	<p>Do not use depth information for navigation while the picture advance speed is set to "stop".</p> <p>The depth indication is not refreshed while the picture is stopped. Use of depth data for navigation in this case could lead to grounding or other dangerous situation.</p>
	<p>Do not transmit with the transducer out of water.</p> <p>The transducer will be damaged.</p>

 CAUTION	
	<p>Adjust the gain properly.</p> <p>Too little gain may present no picture. Too much gain shows excessive noise on the picture.</p>
	<p>Keep the bottom echo and depth indication shown stably.</p> <p>Unstable bottom echo and depth indication can result in grounding if the vessel is steered according to the informations on the display. If unstable, adjust the setting of [Bottom Level] or [TX Power].</p>
	<p>Do not connect/disconnect the cables connected to the processor unit while turning the power on.</p> <p>The unit may be damaged.</p>

Warning Label

Warning label is attached to the Processor Unit. Do not remove the label.
If the label is missing or illegible, contact a FURUNO agent or dealer about replacement.

	 DANGER
	<p>Electrical shock hazard. Do not remove cover. No user-serviceable parts inside. Turn off power before servicing.</p>
	 危険
	<p>感電の恐れあり。 サービスマン以外の方はカバーを開けな いで下さい。内部には高電圧部分が数多 くあり、万一さわると危険です。 サービスマンがサービスを行う前には、 必ず電源をOFFにして下さい。</p>

Name: Danger Label
Type: 10-089-7544-0
Code No.: 100-394-370-10

TABLE OF CONTENTS

FOREWORD	vi
SYSTEM CONFIGURATION	x
1. OPERATION	1-1
1.1 Control Description.....	1-1
1.2 How to Turn the Power On or Off.....	1-2
1.3 How to Adjust Display Brilliance and Key Backlighting	1-3
1.4 How to Select Display Mode	1-3
1.4.1 Single frequency display	1-4
1.4.2 Dual frequency display.....	1-5
1.4.3 Zoom display.....	1-5
1.4.4 User 1 and 2 displays.....	1-8
1.5 Side Looking Mode	1-8
1.6 How to Adjust the Range	1-12
1.7 Shifting the Range.....	1-13
1.8 Adjusting the Gain.....	1-14
1.9 Measuring Depth.....	1-14
1.10 Inscribing Lines (TLL).....	1-15
1.11 Scroll Back Mode	1-15
1.12 Menu Operating Procedure.....	1-16
1.13 Fish Size Histogram (FCV-1900G Only)	1-18
1.13.1 How to show the fish size histogram window.....	1-18
1.13.2 How to interpret the fish size histogram window	1-19
1.13.3 How to move the fish size histogram window	1-20
1.14 How to Set Measuring Area for Fish Size Histogram (FCV-1900G Only).....	1-20
1.14.1 Measuring fish in entire area.....	1-21
1.14.2 Measuring fish in a specific depth range.....	1-21
1.14.3 Measuring bottom fish.....	1-22
1.14.4 Measuring fish in a specific area.....	1-22
1.15 Save and Replay a Screenshot.....	1-23
1.15.1 How to save a screenshot.....	1-23
1.15.2 How to replay a screenshot.....	1-24
1.15.3 How to delete a screenshot.....	1-24
1.16 Function Keys	1-25
1.16.1 How to execute a program.....	1-25
1.16.2 How to program the function keys.....	1-26
1.17 Picture Advance Speed.....	1-27
1.18 Rejecting Interference	1-28
1.19 Erasing Weak Echoes.....	1-28
1.20 Rejecting Low Level Noise.....	1-29
1.21 Adjusting TVG	1-30
1.22 A-scope Display	1-31
1.23 Fish Information (ACCU-FISH™).....	1-32
1.23.1 How to activate ACCU-FISH™	1-33
1.23.2 Fish symbols	1-33
1.23.3 Displaying fish info	1-34
1.24 Alarms.....	1-34
1.25 Sonde Mark and V-Temperature Graph.....	1-37
1.25.1 How to show the sonde mark.....	1-37
1.25.2 How to show the V-temperature graph	1-39
1.26 Bottom Discrimination Display	1-40
1.27 Menu Description	1-42

1.27.1 [Sounder] menu	1-42
1.27.2 [Display] menu.....	1-43
1.27.3 [Measurement] menu	1-44
1.27.4 [Data] menu.....	1-45
2. SYSTEM MENU	2-1
2.1 How to Open the [System] Menu.....	2-1
2.2 [User] Menu	2-1
2.3 [Range] Menu	2-5
2.4 [Auto] Menu	2-6
2.5 [TX/RX] Menu	2-6
2.6 [Key] Menu	2-9
2.7 [Language] Menu.....	2-9
2.8 [Units] Menu	2-9
2.9 [NMEA Port Set&Monitor] Menu.....	2-10
2.10 [Calib] Menu	2-11
2.11 [Stabilization] Menu	2-13
2.12 [Data Output Setting] Menu (For Japan)	2-14
2.13 [Save Setting] Menu	2-14
2.14 [Replay Image] Menu	2-15
2.15 [Record Video Data] Menu	2-16
2.16 [Replay Video Data] Menu.....	2-17
3. MAINTENANCE & TROUBLESHOOTING	3-1
3.1 Maintenance	3-1
3.2 Fuse Replacement	3-2
3.3 Troubleshooting.....	3-2
3.4 Error Icon.....	3-4
3.5 Communication Port Monitor.....	3-5
3.6 Diagnostic Test.....	3-6
3.7 LCD Test	3-7
APPENDIX 1 MENU TREE	AP-1
APPENDIX 2 SCREEN LAYOUT.....	AP-7
APPENDIX 3 DISPLAY DIVISION	AP-11
SPECIFICATIONS	SP-1
INDEX	IN-1

FOREWORD

Congratulations on your choice of the FURUNO FCV-1900 series Fish Finder. We are confident you will see why the FURUNO name has become synonymous with quality and reliability.

Since 1948, FURUNO Electric Company has enjoyed an enviable reputation for innovative and dependable marine electronics equipment. This dedication to excellence is furthered by our extensive global network of agents and dealers.

This equipment is designed and constructed to meet the rigorous demands of the marine environment. However, no machine can perform its intended function unless installed, operated and maintained properly. Please carefully read and follow the recommended procedures for operation and maintenance.

Features

The FCV-1900 series are dual frequency Fish Finders. Comprised of a control unit, processor unit and transducer (optional or locally supply), the FCV-1900 series show echo-gram (echo) on a monitor (locally supply). The FCV-1900 series have three models: FCV-1900, FCV-1900B and FCV-1900G. The features available with each models are shown in the table below.

Feature	Model		
	FCV-1900G	FCV-1900B	FCV-1900
Fish Size Histogram	OK	NG	NG
Transmission Mode*	OK	OK	NG
			OK

*: The transmission mode is set by the installer.

You can upgrade the FCV-1900 and FCV-1900B to the high-end model. For details of upgrading, contact your dealer.

The main features of the FCV-1900 series are

- FURUNO Free Synthesizer (FFS) transceiver design allows use of user-selectable operating frequencies.
- Displays the fish echo on a vertical or horizontal monitor.
The figures in this manual follow the horizontal monitor.
- Fish size histogram feature provides approximate fish size in the dense school of fish in graph form (FCV-1900G only).
- The TruEcho CHIRP™ technology delivers significant advancements in signal clarity and target definition (FCV-1900G and FCV-1900B).
- The ACCU-FISH™ feature identifies individual fish with size or depth indication and fish symbol.
- The side looking mode displays the echoes that are received from the port/starboard side.
- Displays echo-gram of up to four frequency on one display.
(Requires Network Sounder DFF1/DFF3 or Bottom Discrimination Sounder BBDS1. For screen layout, see "SCREEN LAYOUT" on page AP-7.)
- Bottom discrimination display provides estimate of bottom composition.
(Requires Bottom Discrimination Sounder BBDS1.)

- Saves and replays videos (see section 2.15 and section 2.16) and screenshots (see section 1.15).
- The scroll back mode shows a maximum of the past two screens of fish finder images.
- With quick gain setting, changes in the gain setting are applied to new echoes as well as all the echoes already on the screen.
- Heaving compensation for stable echo always. (Requires Satellite Compass™.)
- Echo position and other information can be output to a chart plotter.
- Compatible with the Tankenmaru system.
The Tankenmaru system is sold only in Japan (as of May 2015).

Software used with this product

- Ubiquitous QuickBoot Copyright© 2015 Ubiquitous Corp. All rights reserved.
- This product includes software to be licensed under the GNU General Public License (GPL) version 2.0, GNU Lesser General Public Software License (LGPL) version 2.0, Apache, BSD and others. The program(s) is/are free software(s), and you can copy it and/or redistribute it and/or modify it under the terms of the GPL version 2.0 or LGPL version 2.0 as published by the Free Software Foundation. Please access to the following URL if you need source codes: https://www.furuno.co.jp/cgi/cnt_oss_e01.cgi.

CE declaration

With regards to CE declarations, please refer to our website (www.furuno.com) for further information about RoHS conformity declarations.

OpenSSL license information

LICENSE ISSUES

The OpenSSL toolkit stays under a double license, i.e. both the conditions of the OpenSSL License and the original SSLeay license apply to the toolkit. See below for the actual license texts.

OpenSSL License

=====

Copyright (c) 1998-2019 The OpenSSL Project. All rights reserved.

Redistribution and use in source and binary forms, with or without modification, are permitted provided that the following conditions are met:

- 1) Redistributions of source code must retain the above copyright notice, this list of conditions and the following disclaimer.
- 2) Redistributions in binary form must reproduce the above copyright notice, this list of conditions and the following disclaimer in the documentation and/or other materials provided with the distribution.
- 3) All advertising materials mentioning features or use of this software must display the following acknowledgment: "This product includes software developed by the OpenSSL Project for use in the OpenSSL Toolkit. (<http://www.openssl.org/>)"
- 4) The names "OpenSSL Toolkit" and "OpenSSL Project" must not be used to endorse or promote products derived from this software without prior written permission. For written permission, please contact openssl-core@openssl.org.

FOREWORD

- 5) Products derived from this software may not be called "OpenSSL" nor may "OpenSSL" appear in their names without prior written permission of the OpenSSL Project.
- 6) Redistributions of any form whatsoever must retain the following acknowledgment: "This product includes software developed by the OpenSSL Project for use in the OpenSSL Toolkit (<http://www.openssl.org/>)"

THIS SOFTWARE IS PROVIDED BY THE OpenSSL PROJECT ``AS IS" AND ANY EXPRESSED OR IMPLIED WARRANTIES, INCLUDING, BUT NOT LIMITED TO, THE IMPLIED WARRANTIES OF MERCHANTABILITY AND FITNESS FOR A PARTICULAR PURPOSE ARE DISCLAIMED. IN NO EVENT SHALL THE OpenSSL PROJECT OR ITS CONTRIBUTORS BE LIABLE FOR ANY DIRECT, INDIRECT, INCIDENTAL, SPECIAL, EXEMPLARY, OR CONSEQUENTIAL DAMAGES (INCLUDING, BUT NOT LIMITED TO, PROCUREMENT OF SUBSTITUTE GOODS OR SERVICES; LOSS OF USE, DATA, OR PROFITS; OR BUSINESS INTERRUPTION) HOWEVER CAUSED AND ON ANY THEORY OF LIABILITY, WHETHER IN CONTRACT, STRICT LIABILITY, OR TORT (INCLUDING NEGLIGENCE OR OTHERWISE) ARISING IN ANY WAY OUT OF THE USE OF THIS SOFTWARE, EVEN IF ADVISED OF THE POSSIBILITY OF SUCH DAMAGE.

=====

This product includes cryptographic software written by Eric Young (eay@cryptsoft.com). This product includes software written by Tim Hudson (tjh@cryptsoft.com).

Original SSLeay License

Copyright (C) 1995-1998 Eric Young (eay@cryptsoft.com)
All rights reserved.

This package is an SSL implementation written by Eric Young (eay@cryptsoft.com). The implementation was written so as to conform with Netscapes SSL.

This library is free for commercial and non-commercial use as long as the following conditions are aheared to. The following conditions apply to all code found in this distribution, be it the RC4, RSA, lhash, DES, etc., code; not just the SSL code. The SSL documentation included with this distribution is covered by the same copyright terms except that the holder is Tim Hudson (tjh@cryptsoft.com).

Copyright remains Eric Young's, and as such any Copyright notices in the code are not to be removed. If this package is used in a product, Eric Young should be given attribution as the author of the parts of the library used. This can be in the form of a textual message at program startup or in documentation (online or textual) provided with the package.

Redistribution and use in source and binary forms, with or without modification, are permitted provided that the following conditions are met:

- 1) Redistributions of source code must retain the copyright notice, this list of conditions and the following disclaimer.
- 2) Redistributions in binary form must reproduce the above copyright notice, this list of conditions and the following disclaimer in the documentation and/or other materials provided with the distribution.
- 3) All advertising materials mentioning features or use of this software must display the following acknowledgement:
"This product includes cryptographic software written by Eric Young (eay@cryptsoft.com)"
The word 'cryptographic' can be left out if the rouines from the library being used are not cryptographic related :-).

- 4) If you include any Windows specific code (or a derivative thereof) from the apps directory (application code) you must include an acknowledgement: "This product includes software written by Tim Hudson (tjh@cryptsoft.com)"

THIS SOFTWARE IS PROVIDED BY ERIC YOUNG ``AS IS" AND ANY EXPRESS OR IMPLIED WARRANTIES, INCLUDING, BUT NOT LIMITED TO, THE IMPLIED WARRANTIES OF MERCHANTABILITY AND FITNESS FOR A PARTICULAR PURPOSE ARE DISCLAIMED. IN NO EVENT SHALL THE AUTHOR OR CONTRIBUTORS BE LIABLE FOR ANY DIRECT, INDIRECT, INCIDENTAL, SPECIAL, EXEMPLARY, OR CONSEQUENTIAL DAMAGES (INCLUDING, BUT NOT LIMITED TO, PROCUREMENT OF SUBSTITUTE GOODS OR SERVICES; LOSS OF USE, DATA, OR PROFITS; OR BUSINESS INTERRUPTION) HOWEVER CAUSED AND ON ANY THEORY OF LIABILITY, WHETHER IN CONTRACT, STRICT LIABILITY, OR TORT (INCLUDING NEGLIGENCE OR OTHERWISE) ARISING IN ANY WAY OUT OF THE USE OF THIS SOFTWARE, EVEN IF ADVISED OF THE POSSIBILITY OF SUCH DAMAGE.

The licence and distribution terms for any publically available version or derivative of this code cannot be changed. i.e. this code cannot simply be copied and put under another distribution licence [including the GNU Public Licence.]

SYSTEM CONFIGURATION

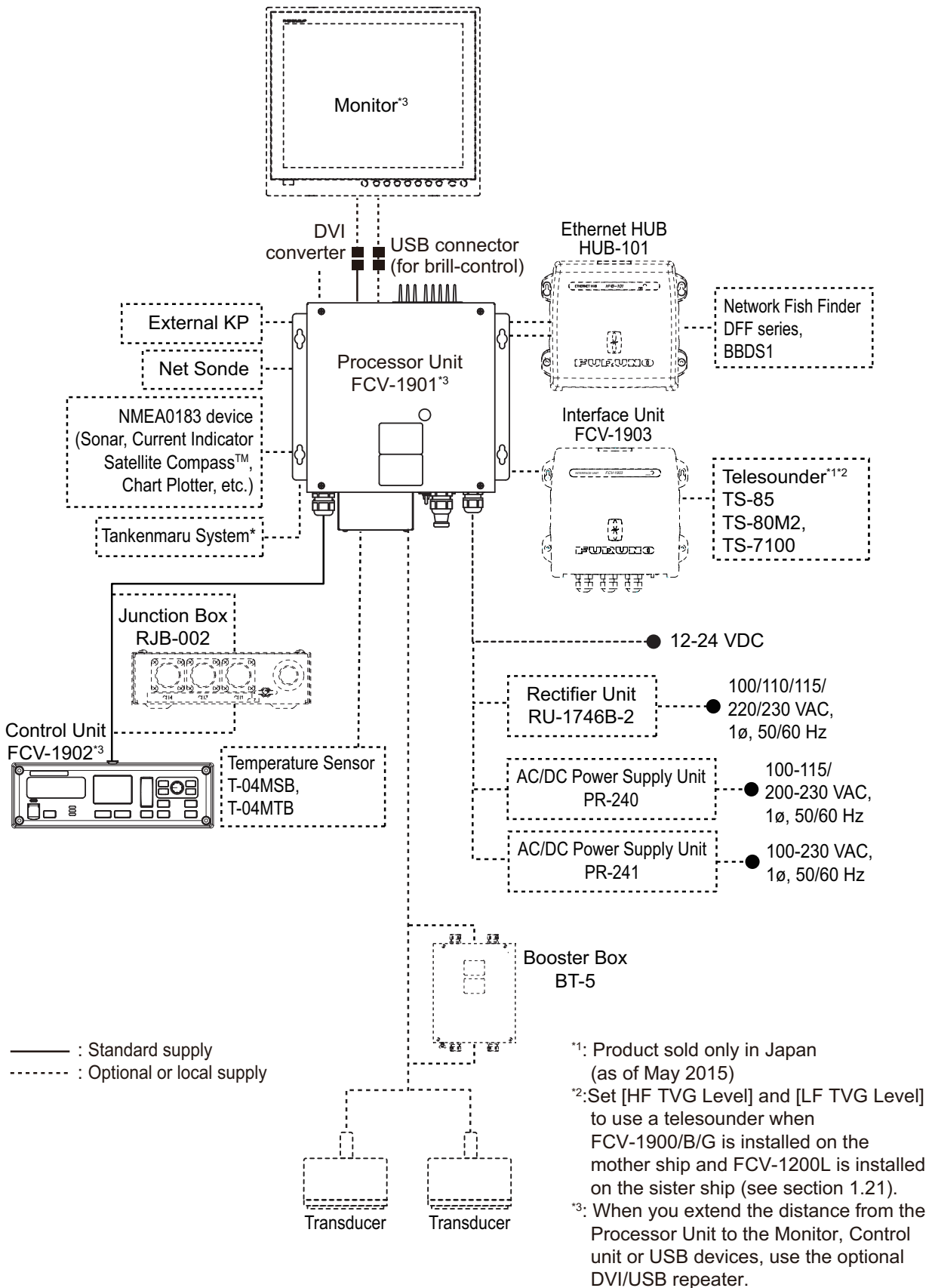

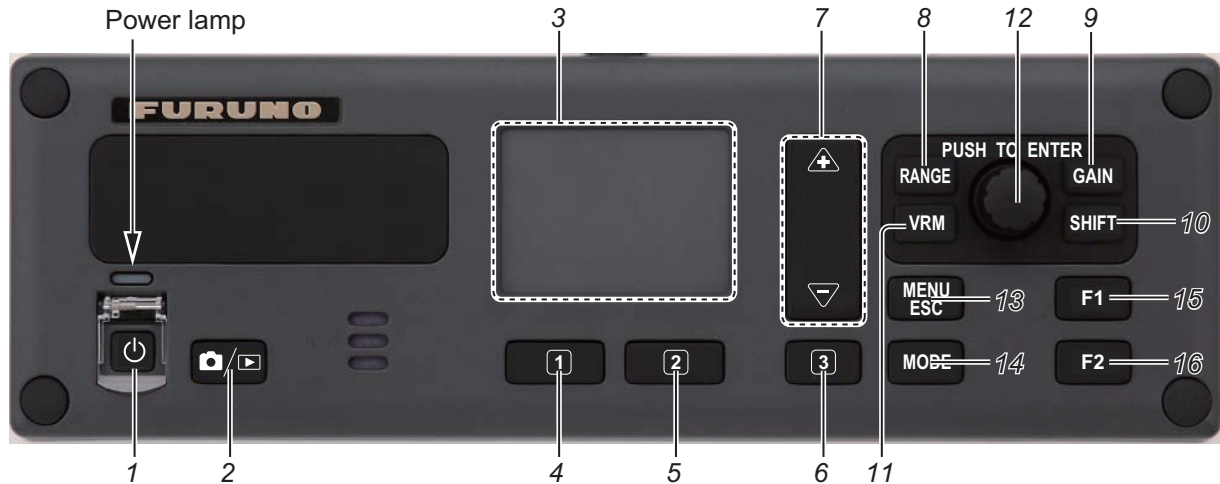

1. OPERATION

1.1 Control Description





No.	Key	Description
1		Short press: Turn the power on. Open the brilliance adjustment window. Long press: Turn the power off.
2		Short press: Take a screenshot. Long press: Open the preview window of the screenshot.
3	Touchpad	For FCV-1900G <ul style="list-style-type: none"> • Move the measuring area marker when the measuring mode is [Specific Range] or [Specific Area] and the function of the touchpad is to control measuring area. • Move the fish size histogram window when the function of the touchpad is to move the fish size histogram window. For FCV-1900 and FCV-1900B <ul style="list-style-type: none"> • Move the VRM (Variable Range Marker) when VRM key is in the VRM mode. • Move the TLL line (green dashed line) when VRM key is in the TLL mode.
4		For FCV-1900G <ul style="list-style-type: none"> • Short press: Switch the function of the touchpad between controlling the measurement area and moving the fish size histogram window. • Long press: No function. For FCV-1900 and FCV-1900B <ul style="list-style-type: none"> • Short press: Execute assigned program. • Long press: Open the menu to assign the function.
5		For FCV-1900G <ul style="list-style-type: none"> • Short press: Switch the measuring mode (see section 1.14). • Long press: No function. For FCV-1900 and FCV-1900B <ul style="list-style-type: none"> • Short press: Execute assigned program. • Long press: Open the menu to assign the function.
6		For FCV-1900G <ul style="list-style-type: none"> • Short press: Switch the setting direction between lengthwise direction (depth) and cross direction (time) when the measuring mode is [Bottom Trace] or [Specific Area]. • Long press: No function. For FCV-1900 and FCV-1900B <ul style="list-style-type: none"> • Short press: Execute assigned program. • Long press: Open the menu to assign the function.

1. OPERATION

No.	Key	Description	
7	 , 	For FCV-1900G • Adjust the measuring area when the measuring mode is [Specific Range], [Bottom Trace], or [Specific Area]. For FCV-1900 and FCV-1900B • Adjust the display range. • Adjust the range, shift.	
8	RANGE	Assign the range / shift control function to the ENTER knob.	
9	GAIN	Assign the gain control function to the ENTER knob.	
10	SHIFT	Assign the shift range control function to the ENTER knob.	
11	VRM	• Assign the VRM and TLL control functions to the ENTER knob. • Switch the VRM key's mode: VRM mode and TLL mode.	
12	ENTER knob	Rotate	• Adjust the display range, gain, VRM, TLL line, or shift range. • Move the cursor*. • Adjust setting value*. *: Clockwise rotation increases the value and moves the cursor downward and rightward. Counterclockwise rotation decreases the value and moves the cursor upward and leftward.
		Short press	• Confirm the selection. • Output the TLL information to a chart plotter.
		Long press	• Activate the scroll back mode.
13	MENU/ESC	• Open/close the menu. • Escape from current operation.	
14	MODE	Open the [Mode] window to select the display mode.	
15, 16	F1, F2	Short press: Execute assigned program. Long press: Open the [FUNC] tab to assign the function.	

1.2 How to Turn the Power On or Off

Press the  key to turn on the power. A beep sounds and the display changes in the following sequence: FURUNO display → model display, then the last-used display is shown. When the key brilliance is set to other than "0", the power lamp above the key lights.

To turn off the power, press the  key more than three seconds. The time remaining until power off is counted down on the screen.

Note 1: Do not turn off the ship's mains when the processor unit is running. The setting values may not be saved properly.

Note 2: The processor unit consumes electric power when the power is off (stand-by power consumption: 0.06 A). It is recommended to turn off the fish finder at the ship's mains if you will not be using it for some time.

Note 3: If the FCV-1900B and FCV-1900G fails the license confirmation after turning the power on, the message "License confirmation failed. The equipment will start up with the standard version." appears. In this case, select [Yes] to start up with the FCV-1900 and ask your dealer for advise.

Note 4: If the communication error between the MAIN board and CTRL board in the processor unit occurs at startup, the message "The connection is timed out" appears. Turn the power off, then contact your dealer to check the connection between the

MAIN board and CTRL board in the processor unit or the connection between the processor unit and Ethernet HUB (HUB-101).

1.3 How to Adjust Display Brilliance and Key Backlighting

Adjust the display brilliance and key backlighting as follows. The display brilliance control is effective for these FURUNO monitors: MU-190, MU-190V, MU-150HD, MU-190HD, MU-231.

1. Press the  key to show the brilliance adjustment window.

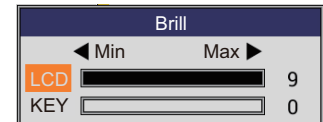

2. Rotate the **ENTER** knob to select [LCD] or [KEY].
 - [LCD]: Adjust the display brilliance (setting range: 0 to 9).
 - [KEY]: Adjust the backlighting for the keys (setting range: 0 to 4).
3. Rotate the **ENTER** knob to change the setting value, then push the knob. The brilliance adjustment window is automatically closed if there is no operation for approx. six seconds.

1.4 How to Select Display Mode

This equipment has seven display modes. Select the display mode as shown in the procedure below.

1. Press the **MODE** key to open the [Mode] window. The [Mode] window is automatically closed if there is no operation for approx. six seconds.
2. Rotate the **ENTER** knob to select the display mode, then push the knob. The screen related to the mode you selected appears. The display mode in use appears at the top left corner of the screen.

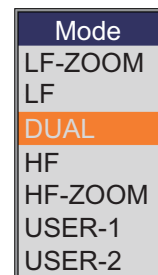

Indication	Meaning	Indication	Meaning
HF	High frequency	HF1	High frequency with gain setting 1
LF	Low frequency	HF2	High frequency with gain setting 2
HF_BL	High frequency bottom lock	LF1	Low frequency with gain setting 1
LF_BL	Low frequency bottom lock	LF2	Low frequency with gain setting 2
HF_BZ	High frequency bottom zoom	Mix	Mix display
LF_BZ	Low frequency bottom zoom	HE	High frequency external fish finder
HF_MZ	High frequency marker zoom	LE	Low frequency external fish finder
LF_MZ	Low frequency marker zoom	HT	High frequency telesounder
HF_BD	High frequency bottom discrim	LT	Low frequency telesounder
LF_BD	Low frequency bottom discrim		

1. OPERATION

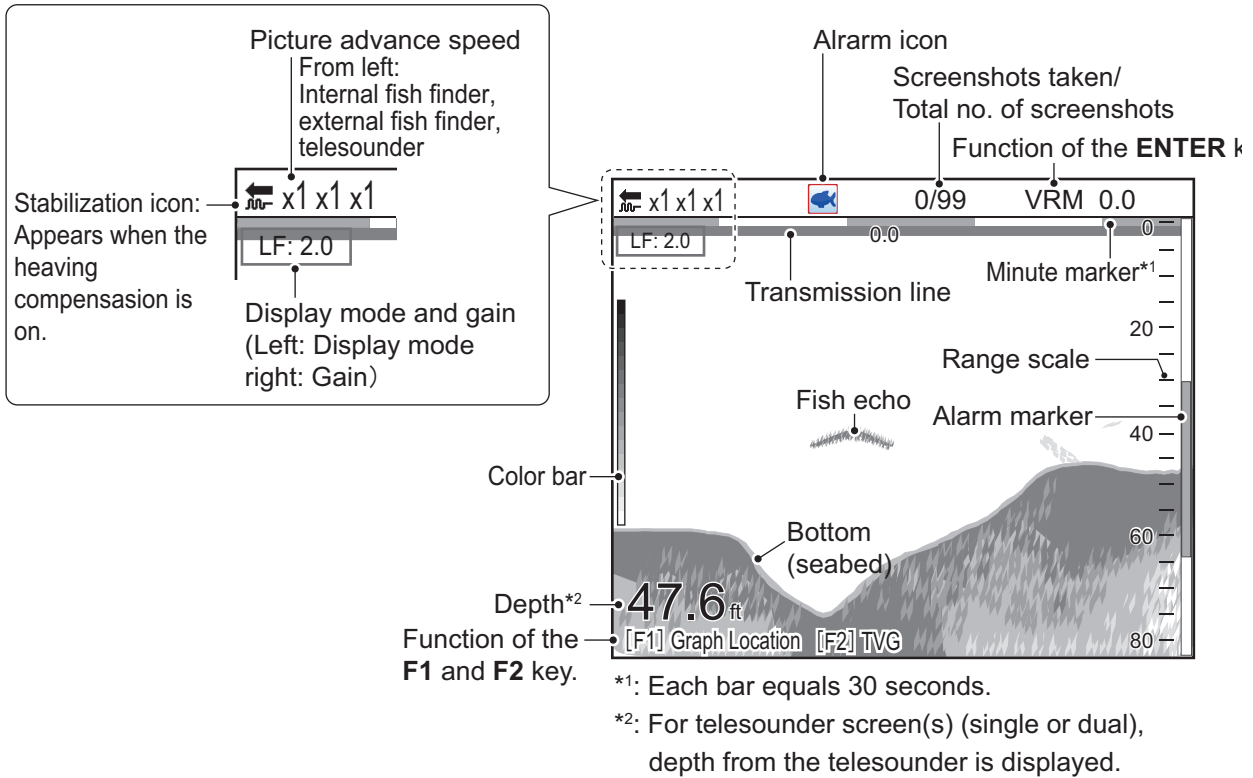

Display example (low frequency echo)

1.4.1 Single frequency display

Low frequency

The lower the frequency of the ultrasonic signal, the wider the detection area. Therefore, the low frequency is useful for general detection and judging bottom condition.

High frequency

The higher the frequency of the ultrasonic signal, the better the resolution. For this reason the high frequency is ideal for detailed observation of school of fish.

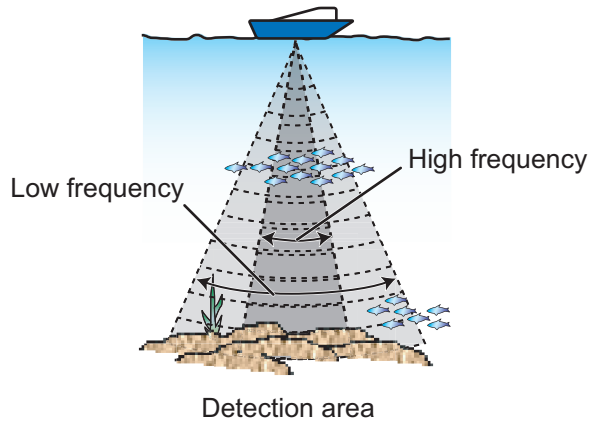

1.4.2 Dual frequency display

The low frequency echo appears on the left; the high frequency echo on the right. This display is useful for comparing underwater conditions with two different frequencies.

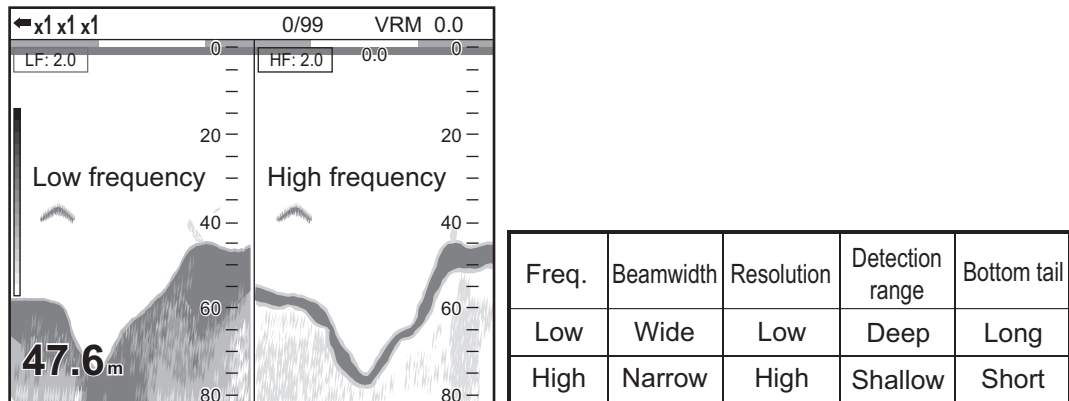

Note: The dual frequency and zoom display are divided vertically in the default setting. You can divide the display horizontally (see page 1-43).

1.4.3 Zoom display

The zoom displays expand the specified area of the single frequency echo. Four modes are available: bottom lock, bottom zoom, marker zoom and bottom discrimination. The default mode is bottom lock. For how to change the zoom mode, see page 1-43.

Note: In side looking mode, the zoom display is unavailable for the display that shows the port or starboard side echoes. For details about side looking mode, see section 1.5.

Bottom lock display

The bottom lock display provides a normal picture on the right half of the screen and a 16-9000 feet (default: 16 feet) wide layer in contact with the bottom is expanded onto the left half of the screen. This mode is useful for detecting bottom fish.

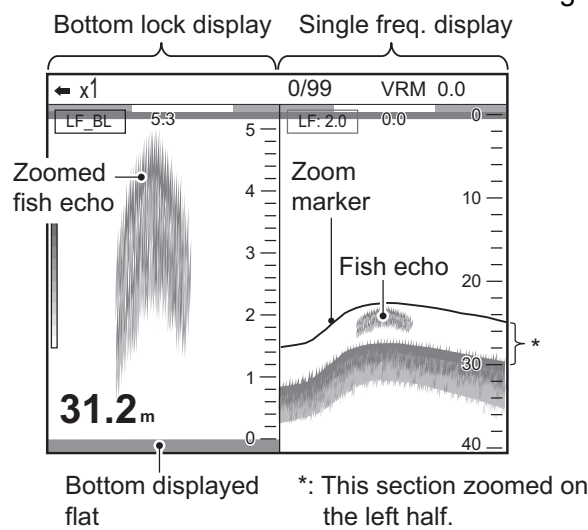

Note 1: To adjust the range of the zoom display, go to the [Range] menu (see section 2.3).

Note 2: To show or hide the zoom marker, go to the [Display] menu (see page 1-43).

Bottom zoom display

This mode expands bottom and bottom fish on the left-half window, and is useful for determining bottom contour. When the bottom depth increases, the display automatically shifts to keep the bottom echo at the lower part of the screen.

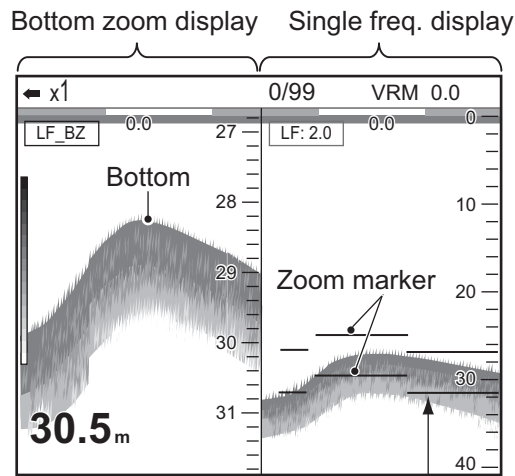

Zoom marker automatically follows change in depth.

Marker zoom display

The marker zoom mode expands specified area of the normal picture to full vertical size of the screen on the left-half window. You may specify the portion to expand by operating the VRM (Variable Range Marker). The area between the VRM and zoom marker is expanded. This mode is useful for determining the size of fish in the midwater.

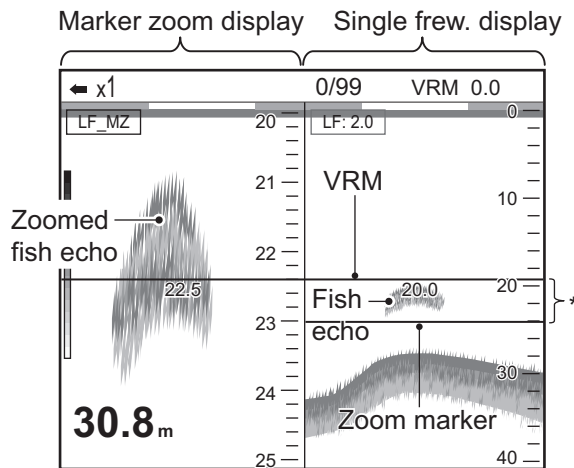

*: This section zoomed.

Bottom discrimination display

The bottom discrimination display has two modes: Bottom discrimination 1/2 and Bottom discrimination 1/3. For how to change the mode, see page 2-5.

- **Bottom discrimination 1/2 display:**

The bottom discrimination 1/2 screen shows the single frequency echo on the right half of the screen and the bottom discrimination display occupies the left half of the screen. The bottom discrimination display shows the bottom as a straight line, which is useful for determining bottom hardness.

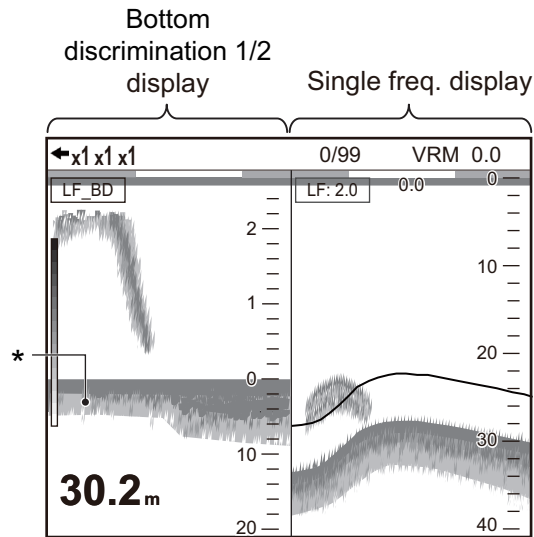

*: Bottom tail
 Long tail = Hard bottom
 Short tail = Soft bottom

- **Bottom discrimination 1/3 display:**

This display is similar to the bottom discrimination 1/2 display except the bottom discriminator display occupies the bottom one-third of the left half of the screen as below.

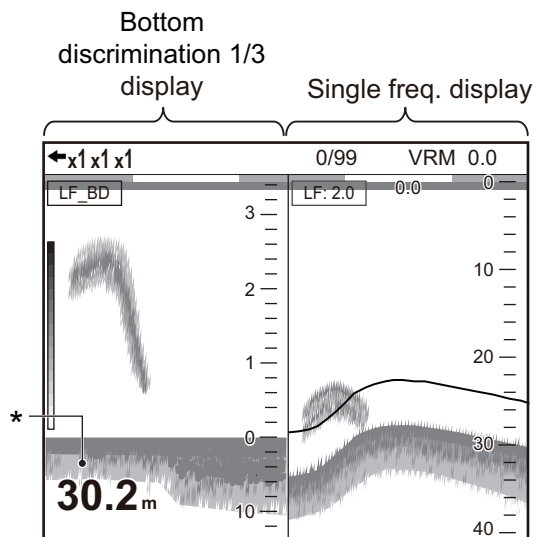

*: Bottom tail
 Long tail = Hard bottom
 Short tail = Soft bottom

1.4.4 User 1 and 2 displays

The user displays let you customize displays as desired. Two displays are provided and the default settings for each are

User 1 display: This screen is split vertically three ways and is comprised of LF, HF and MIX displays.

User 2 display: This display is split in fourths and is comprised of LF, HF, LF bottom zoom and HF bottom zoom displays.

For how to customize user displays, see section 2.2.

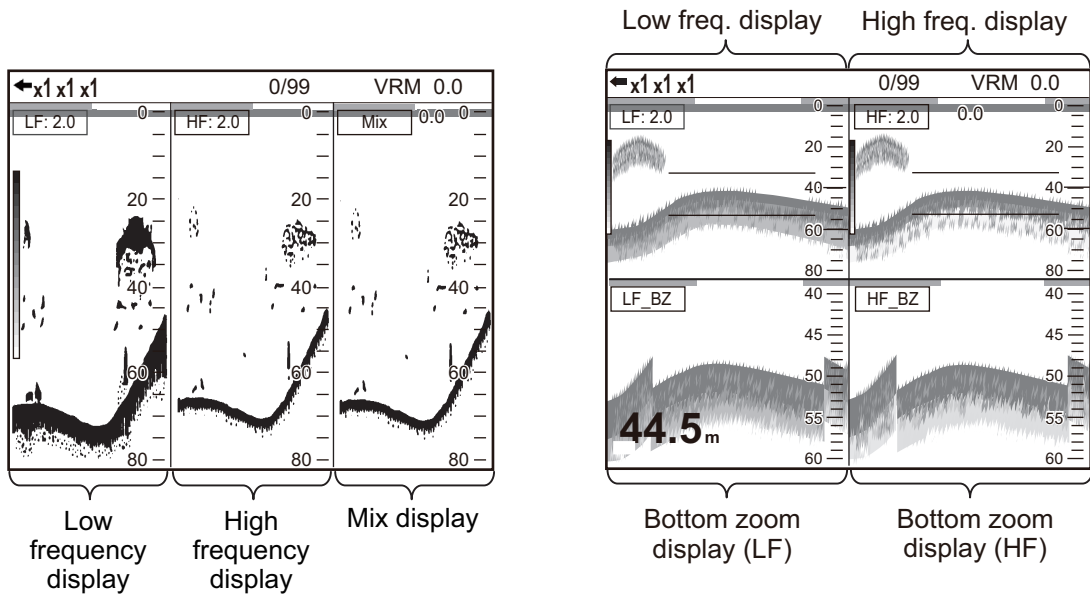

Default user 1 and user 2 display

1.5 Side Looking Mode

The side looking mode can display the echoes that are received from the port/starboard side. This mode displays the following information:

- Distance between a school of fish and net
- Distance between the net and bottom
- Distance between a school of fish and own ship

This information is particularly useful for fisheries such as purse seine, trawl, white bait and tuna etc.

In normal mode, you estimate the bottom hardness by the bottom tail, however in side looking mode, you can estimate the hardness by bottom echo color. Therefore, it is easier to estimate the hardness than in normal mode.

In side looking mode, the latest echoes appear at the top of the screen and the oldest echoes appear at the bottom of the screen.

Note: To use side looking mode, the transducer must be faced in the port/starboard direction and set up in the installation menu. The installation menu is not user-accessible. To use this mode, contact your dealer. Before activating this mode, save the current setting data to a USB flash memory (see page 2-15).

Display examples for side looking mode (for four-way split user displays)

- Example 1: When transducers for the external fish finder face port and starboard side, the side looking mode screen appears at the left of the display.

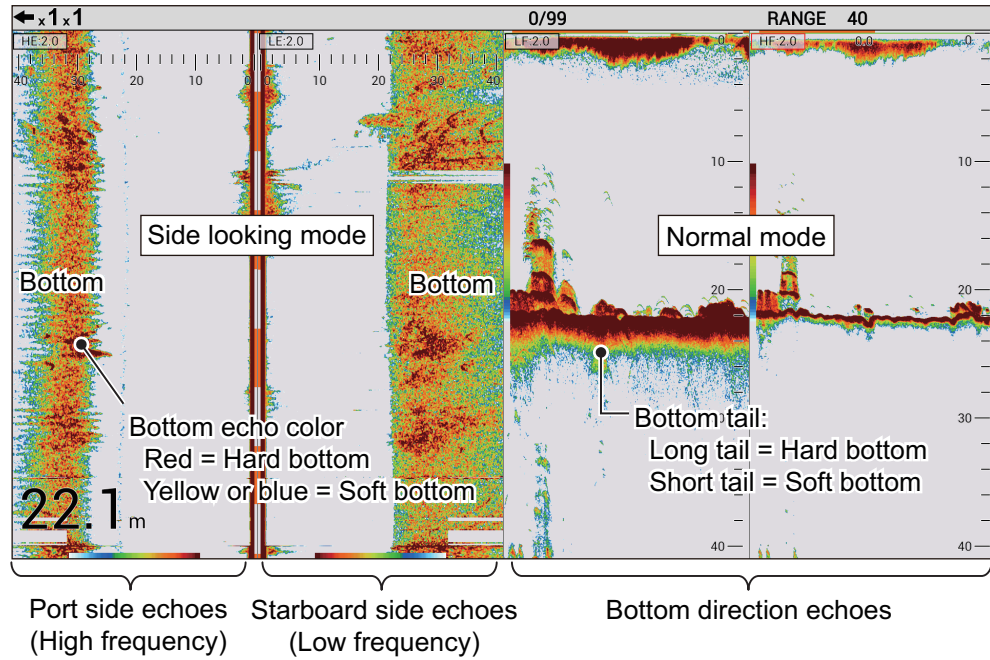

- Example 2: When both transducers for the external fish finder face starboard side, the side looking mode screen appears at the right of the display.

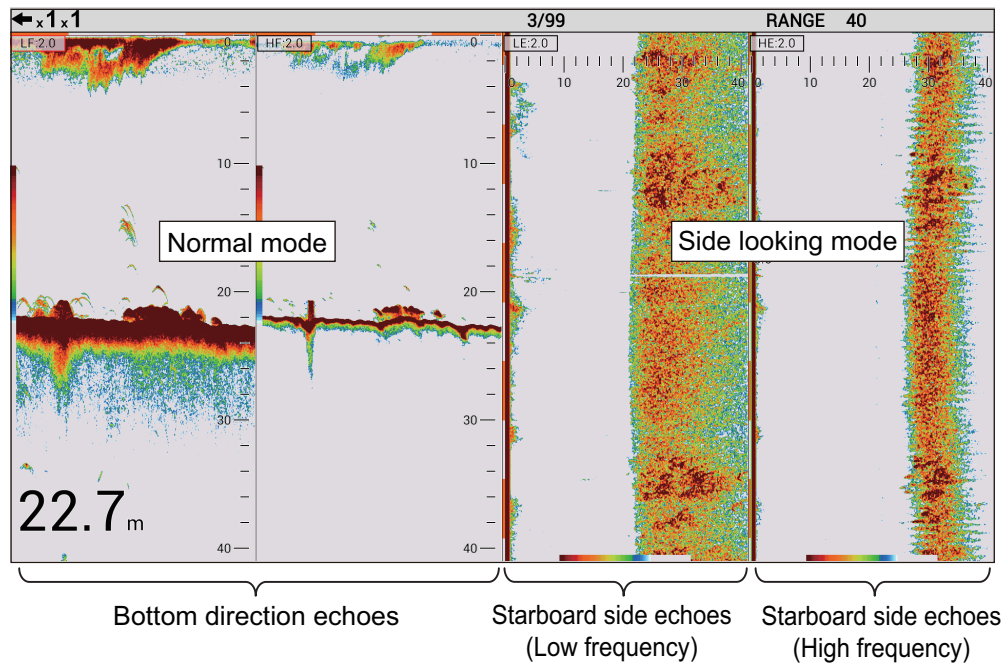

1. OPERATION

- Example 3: When both transducers for the external fish finder face port side, the side looking mode screen appears at the left of the display.

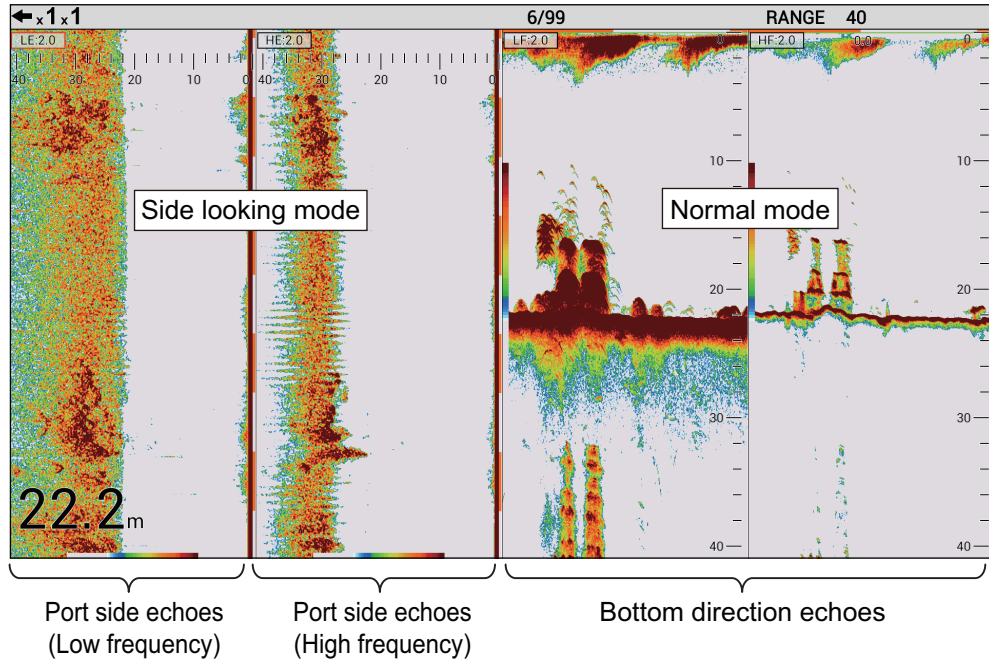

Unavailable menus in side looking mode

Menu items shown in the table below are unavailable or limited in side looking mode. Unavailable menu items are grayed out and inoperative.

Note: Menu settings listed in the table below may be changed automatically according to the side looking setting. Also, the setting before activating side looking mode cannot be restored even if side looking mode is deactivated. Load the setting data saved in a USB flash memory to restore the setting (see page 2-15).

For [Setting] tab

Menu item	Side looking setting	Setting item	Available
[Sounder] menu			
White Edge	Side looking mode is active and both of transducer for HF/LF face port/starboard side.	Off	N/A
Bottom Zone	<ul style="list-style-type: none"> • Side looking mode is active and only any one transducer for HF/LF faces bottom. • Side looking mode is active and both transducers for HF/LF face port/starboard side. 	Keep the setting before activating side looking mode.	N/A
[Display] menu			
A-Scope	Side looking mode is active and both transducers for HF/LF face port/starboard side.	Off	N/A
Zoom Marker		Off	N/A
Depth Size		Off	N/A
Display Division	Side looking mode is active.	<input type="checkbox"/>	N/A
Window Size		1:1	N/A
[Measurement] menu*¹			
ACCU-FISH	<ul style="list-style-type: none"> • Side looking mode is active and only any one transducer for HF/LF faces bottom. • Side looking mode is active and both transducers for HF/LF face port/starboard side. 	Off	N/A

Menu item	Side looking setting	Setting item	Available
[Alarm] menu			
Bottom	Side looking mode is active and both transducers for HF/LF face port/starboard side.	Off	N/A
Fish (Normal)		Off	N/A
Fish (B/L)		Off	N/A
Fish Size		Off	N/A
[Data] menu			
Sonde Mark Display	Side looking mode is active and both transducers for HF/LF face port/starboard side.	Off	N/A
Sonde Graph		Off	N/A
[User] menu			
Screen Lay-out	Side looking mode is active.		✓ (limited)
Display Mode		For no split: LE, HE For two-way split: LE+HE For three-way split: LF+HZm+HF* ³ , LZm+LF+HF* ³ , LF+HF+MIX* ³ , HE+LF+HF, LE+LF+HF For four-way split: LZm+LF+HZm+HF* ³ , LF+HF1+HF2+MIX* ³ , HF+LF1+LF2+MIX* ³ , LE+HE+LF+HF,	✓ (limited)
[Range] menu			
Zoom Range	Side looking mode is active and both transducers for HF/LF face port/starboard side.	Keep the setting before activating side looking mode.	N/A
B/L Range			N/A
Discrim Zoom			N/A
[Auto] menu			
Auto	Side looking mode is active.	Off	N/A
[TX/RX] menu			
HF TX Power	Side looking mode is active and transducer for HF faces port/starboard side.	Off, 1 to 10 (Auto is unavailable)	✓ (limited)
LF TX Power	Side looking mode is active and transducer for LF faces port/starboard side.		✓ (limited)
[Units] menu			
Fish Size	<ul style="list-style-type: none"> Side looking mode is active and only any one transducer for HF/LF faces bottom. Side looking mode is active and both transducers for HF/LF face port/starboard side. 	Keep the setting before activating side looking mode.	N/A
[Calib] menu			
Bottom Level	Side looking mode is active.	Keep the setting before activating side looking mode.	N/A

1. OPERATION

Menu item	Side looking setting	Setting item	Available
Fish Size	<ul style="list-style-type: none"> Side looking mode is active and only any one transducer for HF/LF faces bottom. Side looking mode is active and both transducers for HF/LF face port/starboard side. 	Keep the setting before activating side looking mode.	N/A
[Stabilization] menu* ¹			
Stabilization	<ul style="list-style-type: none"> Side looking mode is active and only any one transducer for HF/LF faces bottom. Side looking mode is active and both transducers for HF/LF face port/starboard side. 	Off	N/A
[Data Output Setting] menu* ¹			
Tankenmaru Output	<ul style="list-style-type: none"> Side looking mode is active and only any one transducer for HF/LF faces bottom. 	Off	N/A
Pic. Sync	<ul style="list-style-type: none"> Side looking mode is active and both transducers for HF/LF face port/starboard side. 	Off	N/A

*¹: Unavailable menus other than when side looking mode is active and both of the transducer for HF/LF face bottom.

*²: Not available when both of transducer for HF/LF face port/starboard side.

*³: Available when both of transducer for HF/LF face bottom.

For [External fish finder] tab

Menu item	Side looking setting	Setting item	Available
[Display] menu*			
Bottom Discrim	Side looking mode is active.	Off	N/A
Legend		Off	N/A
[Measurement] menu*			
ACCU-FISH	Side looking mode is active.	Off	N/A
[Calib] menu			
Bottom Level	Side looking mode is active.	Keep the setting before activating side looking mode.	N/A
Fish Size			N/A

*: Inoperative menus when side looking mode is active.

1.6 How to Adjust the Range

Select the display range indicated on the screen. Default settings for the display range are shown below.

Unit	Range							
	1	2	3	4	5	6	7	8
meter	10	20	40	80	150	300	500	1000
feet	30	60	120	250	500	1000	1600	3000
fathoms	5	10	20	40	80	160	250	500
Hiro*	6	12	25	50	100	200	300	600
passi/braza	6	12	25	50	100	200	300	600

*: Japanese unit of depth measurement.

1. Press the **RANGE** key to assign the range control function to the **ENTER** knob.
2. Rotate the **ENTER** knob to select the display range.
The current setting value appears at the upper right of the display.

Note 1: For FCV-1900 and FCV-1900B, you can select the display range, shift by pressing the \triangle or ∇ key.

Note 2: Basic ranges may be preset as desired, on the [Range] menu (see section 2.3).

Note 3: The range can be adjusted automatically to display the bottom echo on the screen always. For how to turn on the auto range mode, see page 2-6. The range shift and range control are inoperative in the auto range mode.

Note 4: In the dual frequency display, the range for the low and high frequencies can be adjusted mutually or independently. Turn on [Split Range] in the [Range] menu to enable independent adjustment (see page 2-6).

Adjusting the range in the dual frequency and user display

The range of the each echo display (other than mix and zoom display) can be set individually on the dual frequency and user display. The range shift and gain control also can be set individually.

Note: To set the range individually, turn on [Split Range] in the [Range] menu. The range of the external fish finder and telesounder can set individually regardless of the setting for [Split Range].

1. Press the **RANGE** key to select the display to adjust the range.

The red cursor appears at the indication of the mode and gain on the selected display. For example of the four-way split display, the cursor moves in the sequence as shown in the figure right.

Note: The indication of the mode and gain does not appear when the [Mode&Gain Display] is turned off.

2. Rotate the **ENTER** knob to select the display range.
The range of the selected display changes.

Red cursor appears on the selected display.

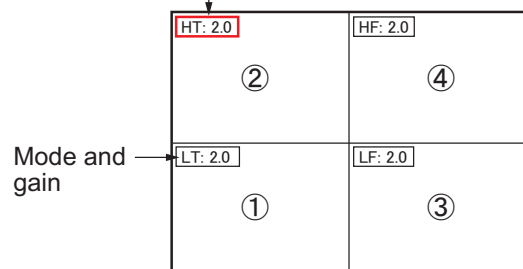

Example: Four-way split display

1.7 Shifting the Range

The basic range and range shifting functions used together give you the means to select the depth you can see on the screen. The basic range can be thought of as providing a “window” into the water column and range shifting as moving the “window” to the desired depth.

Note: This function is inoperative when the auto range or auto shift mode (see page 2-6) is active.

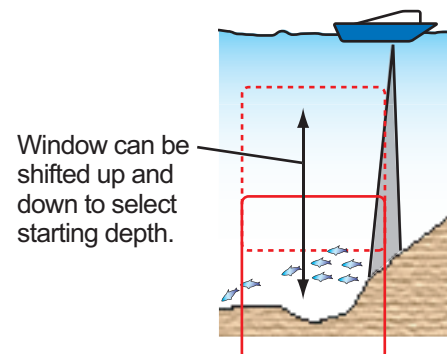

1. OPERATION

1. Press the **SHIFT** key to assign the range shift control function to the **ENTER** knob. When you press the **SHIFT** key while the auto range mode is active, "N/A" appears at the upper right of the display.
2. For the user display, press the **SHIFT** key several times to select the display to adjust the range shift.
3. Rotate the **ENTER** knob to select the amount of shift desired. The current setting value appears at the upper right of the display.

Note: The bottom echo may be lost if the amount of shift is greater than actual depth.

1.8 Adjusting the Gain

Adjust the gain according to signal strength.

 **CAUTION**

 **Adjust the gain properly.**

Too little gain may present no picture.
Too much gain shows excessive noise on the picture.

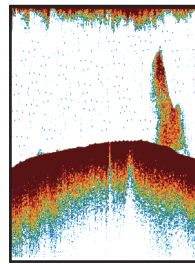

Gain too high

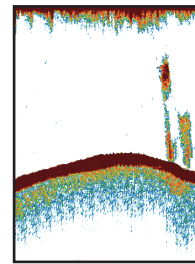

Gain proper

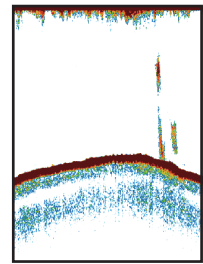

Gain too low

1. Press the **GAIN** key to assign the gain control function to the **ENTER** knob.
2. For the dual frequency and user display (other than mix and zoom displays), press the **GAIN** key several times to select the display to adjust the gain.
3. Rotate the **ENTER** knob to adjust the gain so fish echoes are clearly displayed with minimal noise on the screen (setting range: 0.0 to 10.0). The new gain setting is also applied to past echoes. The current setting value appears at the upper right of the display.

1.9 Measuring Depth

The VRM (Variable Range Marker) measures the depth to a school of fish, etc.

1. Press the **VRM** key to assign the VRM control function to the **ENTER** knob.
2. Rotate the **ENTER** knob to place the VRM on the object to measure depth.
Note: For FCV-1900B and FCV-1900G, you can control the VRM by moving your finger across the touchpad.
3. Read the VRM depth just above the VRM.

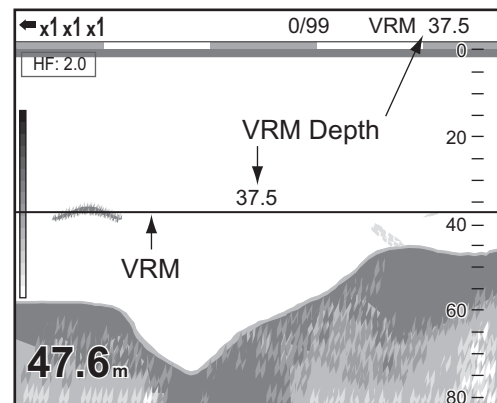

1.10 Inscribing Lines (TLL)

You may inscribe vertical lines (TLL lines) on the display to mark schools of fish, shoals, etc. The position at the same time a line inscribed is output to a chart plotter.

Note 1: This function requires the own ship's position data from a position-fixing equipment.

Note 2: The following procedure is not available in the two-way split screen for tele-sounder ([LT+HT]).

1. Press the **VRM** key twice to show [TLL] at the upper right of the display.
The indication at upper right of the display changes in the sequence: VRM → TLL → VRM → ... by pressing the **VRM** key. When [TLL] appears at the upper right of the display, the TLL line (green dashed line) appears at the right of the display and the picture is stopped.
2. Rotate the **ENTER** knob to place the TLL line on a school of fish, shoals, etc.
Note: For FCV-1900B and FCV-1900G, you can control the TLL line by moving your finger across the touchpad.
3. Push the **ENTER** knob.
The green dashed line changes to the red solid line and the current echoes appear on the display. At this time, the TLL sentence is output to a chart plotter in the default setting.
Note: The data included in the TLL sentence can be set on the [NMEA Port Set&Monitor] menu (see section 2.9).

1.11 Scroll Back Mode

The scroll back mode shows a maximum of the past two screens of fish finder images.

How to activate the scroll back mode

1. Long press the **ENTER** knob to activate the scroll back mode.
[SCROLL BACK] appears at the upper right of the display.
2. Rotate the **ENTER** knob in the counterclockwise direction to show the past echo. Counter clockwise rotation moves the screen leftward (past direction). When the past echo is displayed,  icon appears at the top of the depth scale. Clockwise rotation moves the screen rightward. Rotate the **ENTER** knob hard-over to the clockwise direction to shown the current echo screen.

How to deactivate the scroll back mode

1. Rotate the **ENTER** knob hard-over to the clockwise direction or long push the **ENTER** knob to shown the current echo screen. At this time,  icon disappears.
2. Press the **RANGE**, **VRM**, **GAIN** or **SHIFT** key to deactivate the scroll back mode.

1.12 Menu Operating Procedure

This equipment has six menus: [Sounder], [Display], [Measurement], [Alarm], [Data], and [System].

Below is the basic menu operating procedure.

1. Press the **MENU/ESC** key and open the [Setting] tab.

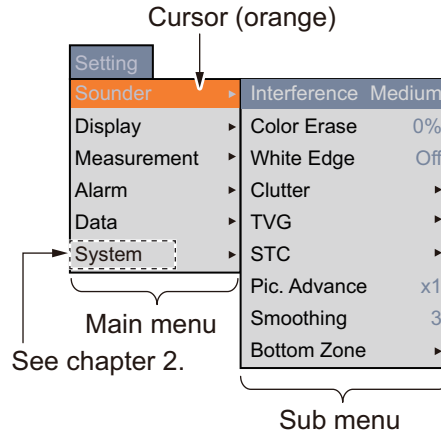

Note: When an external fish finder and telesounder are connected, the [External fish finder] tab and [Telesounder] tab appear next to the [Setting] tab. For details, see page 1-17. The [Setting] tab adjusts the internal fish finder.

2. Rotate the **ENTER** knob to select a menu item.
The cursor (orange) highlights current selection. The items in the right window change with menu selected.
3. Push the **ENTER** knob to send the cursor to the sub menu item window.
The cursor (orange) shifts to the sub menu item window (right) and the color of the cursor on the main menu item window changes from orange to gray.
4. Rotate the **ENTER** knob to select a menu item, then push the knob.
The menu item's setting box or setting window appears.

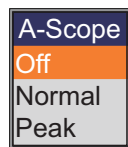

Setting window

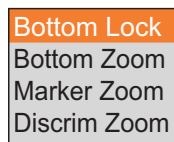

Setting box

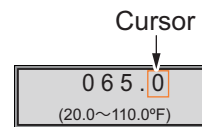

Data input box

5. Change the setting.
For setting window or box
 - 1) Rotate the **ENTER** knob to select a menu item.
 - 2) Push the **ENTER** knob to enter the setting.
The setting window or box disappears. To escape without changing setting, press the **MENU/ESC** key instead of the knob.

For data input box

- 1) Rotate the **ENTER** knob to select the digit to change.
- 2) Push the **ENTER** knob.
- 3) Rotate the **ENTER** knob to change the value.

- 4) Push the **ENTER** knob to enter the setting value.

The cursor moves to the next right digit. After you change the digit in the ones places, the cursor surrounds all digits. If you only change one digit, push the **ENTER** knob several times until the cursor surrounds all digits.

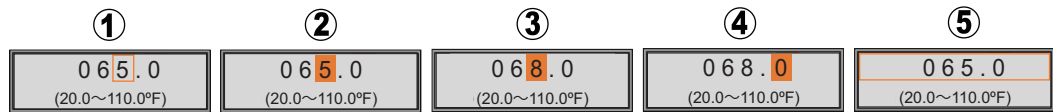

① Select the digit to change.

② The cursor is selecting the digit, the value can be changed.

③ The value has changed.

④ The cursor moves to the right digit after entering the left digit.

⑤ The cursor surrounds all digits.

- 5) Push the **ENTER** knob when the cursor is selecting all digits to confirm setting. The enter box disappears.

6. To select another menu, press the **MENU/ESC** key.

7. Press the **MENU/ESC** key several times to close the menu.

Adjusting the image of the external fish finder and telesounder

When an external fish finder (DFF1, DFF3 or BBDS1) or telesounder (TS-85, TS-80M2 or TS-7100) is connected, it is available to display the echo of the external fish finder and telesounder on the user display. For how to display, see section 2.2. To adjust the image of the external fish finder and telesounder, do as follows;

1. Press the **MENU/ESC** key.

When an external fish finder or telesounder is connected, the [External fish finder] tab ([DFF1], [DFF3] or [BBDS1]) or [Telesounder] tab appears next to the [Setting] tab.

Note 1: The menu items on the [Telesounder] tab are available when this fish finder is installed on the mother ship and [Echo Setting] in the menu is set to [Input], at installation.

Note 2: All the menu items on the [Telesounder] tab can be programmed to the **F1**, **F2** keys. Long push a function key to get into the function key registration mode. See section 1.16.

[External fish finder] tab and [Telesounder] tab

Setting	BBDS1	Telesounder
Sounder		Interference Medium
Display		Color Erase 0%
Measurement		White Edge Off
Alarm		Clutter ▶
Data		TVG ▶
System		STC ▶
		Pic. Advance x1
		Smoothing 3
		Bottom Zone ▶

Example: When BBDS1 and telesounder are connected.

2. Rotate the **ENTER** knob to select a tab.
3. Push the **ENTER** knob to show the menu for the [External fish finder] tab or [Telesounder] tab. The operating procedure is the same as that for the [Setting] tab.

1.13 Fish Size Histogram (FCV-1900G Only)

The fish size histogram window shows approximate fish size in the dense fish school. The fish size histogram window can be displayed on the dual frequency and user display.

Notice for the fish size histogram

- This feature requires an appropriate transducer. For the transducer compatible with this feature, see "EQUIPMENT LISTS" on the installation manual (IME-23860).
- This feature is available when the transmission mode is set to [TruEcho CHIRP] mode. The transmission mode is set by the installer.
- The echo strength of a school of fish changes according to the fish. When the size shown on the fish size histogram differs from the actual size, adjust [Fish Size] on the [Calib] menu to compensate for the difference (see page 2-9).
- A fish whose depth is shallower than 2 m can not be measured. Also, the maximum range depends on the transducer's performance, installation location, and seastate. If the [Zero Line Rejection] on the [Calib] menu is turned on, the fish whose depth is shallower than the transmission line can not be measured.
- In case of a school of fish, echoes overlap one another, so the margin of error will be greater.
- It is not available to activate this feature and ACCU-FISH™ simultaneously.

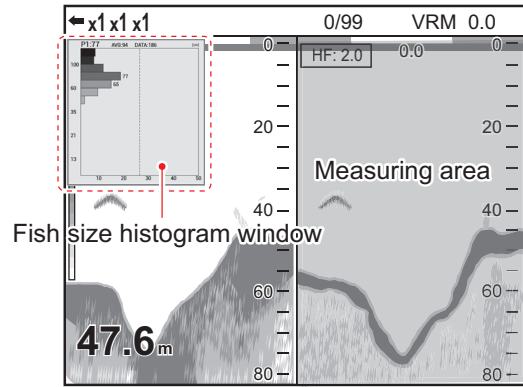

Example: Measuring mode is [Entire Area] mode

1.13.1 How to show the fish size histogram window

Note 1: Turn off [Split Range] on the [Range] menu to show the fish size histogram window.

Note 2: The fish size histogram is unavailable with side looking mode (see page 1-10).

1. Press the **MENU/ESC** key and open the [Setting] tab.
2. Select [Measurement], then push the **ENTER** knob.
3. When the menu items below [Graph Display] are grayed out, set [ACCU-FISH] to [Graph].
 - 1) Select [ACCU-FISH], then push the **ENTER** knob.
 - 2) Select [Graph], then push the **ENTER** knob.
4. Select [Graph Style], then push the **ENTER** knob.

Setting	BBDS1	Telesounder
Sounder		ACCU-FISH Graph
Display		[Graph Display]
Measurement		Graph Style Horizontal
Alarm		Graph Size Small
Data		Graph Location Upper Left
System		Graph Scale End 39inch
		Distributed Scale Start 3%
		Distributed Scale End 50%
		Number of graph bars Max.16 bars
		Transparency Off
		Updating Cycle 3s
		[Mark Display]
		Fish Info Size
		Fish Symbols Fish Mark

5. Select [Horizontal] or [Vertical], then push the **ENTER** knob.

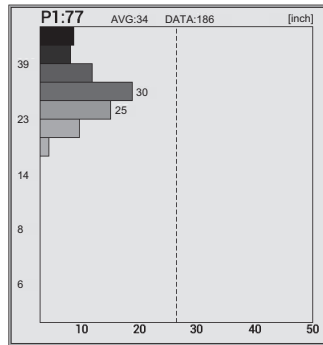

[Horizontal]

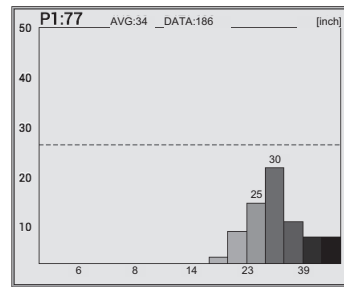

[Vertical]

6. Press the **MENU/ESC** key several times to close the menu.

Note: To close the fish size histogram window, set [ACCU-FISH] to [Off]. When the fish size histogram window is closed, all data measured for it is deleted.

1.13.2 How to interpret the fish size histogram window

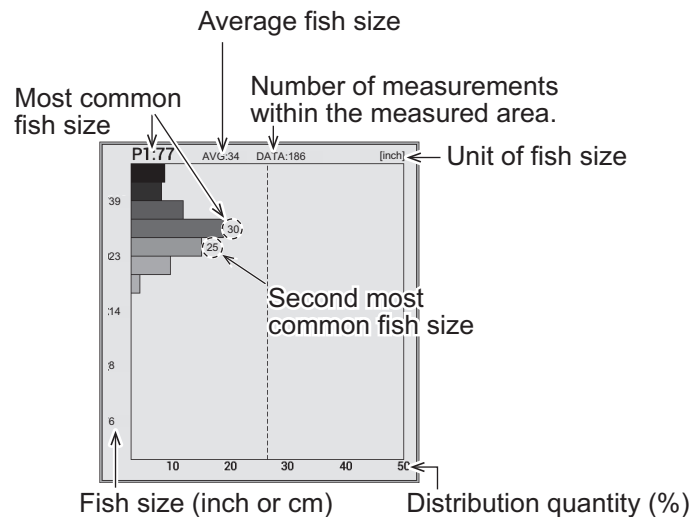

The fish size histogram is a bar graph that shows fish length and distribution within the selected measuring area. In the fish size histogram window above, the following information is shown.

- The most common fish size is 30 inch and accounts for 18% of the total.
- Average size of the fish within the measured area is 34 inch.

Note 1: The number of the graph bars on the fish size histogram window can be changed on the [Measurement] menu (see page 1-45).

Note 2: When [Hue] in the [Display] menu is set to [Std], [Hue1], [Hue2] or [Hue3], fish size data is displayed in one of three colors, based on the reliability of the sensor data. The colors and their meaning are listed in the table below. (For [Hue4], [Hue5] or?[Custom], no color changes.) Recommended to use green for fish size.

Color	Meaning
Green	Data is reliable, fish size is mostly accurate.
Yellow	Data is not totally reliable, fish size is somewhat accurate.
Red	Data is not reliable, fish size accuracy is very low.

1.13.3 How to move the fish size histogram window

How to move the window to the preset location

1. Press the **MENU/ESC** key and open the [Setting] tab.
2. Select [Measurement], then push the **ENTER** knob.
3. Select [Graph Location], then push the **ENTER** knob.
4. Select the location of the window, then push the **ENTER** knob.
5. Press the **MENU/ESC** key several times to close the menu.

How to move the window to the desired location

1. Press the **[1]** key to assign the function of moving the fish size histogram window to the touchpad.
The frame color of the window changes from gray to orange.
2. Move your finger across the touchpad to move the window.
3. Press the **[1]** key to assign the function of adjusting the measuring area to the touchpad.
The frame color of the window changes from orange to gray, and window is fixed.

1.14 How to Set Measuring Area for Fish Size Histogram (FCV-1900G Only)

There are four measuring modes to set the measuring area for the fish size histogram:

- [Entire Area] mode: Measure fish whose depth is shallower than bottom.
- [Specific Area] mode: Measure fish in a specific area.
- [Bottom Trace] mode: Measure fish in an area near the bottom.
- [Specific Range] mode: Measure fish in a specific depth range.

To switch the measuring mode, press the **[2]** key consecutively. The measuring mode changes in the sequence of [Entire Area] → [Specific Range] → [Bottom Lock] → [Specific Area] → [Entire Area] →

1.14.1 Measuring fish in entire area

1. Press the **[2]** key several times to select the [Entire Area] measuring mode. The measuring marker (yellow frame) appears. According to the screen division and layout, the location of the measuring marker changes (vertical split: right, horizontal split: upper, four-way split: upper right).

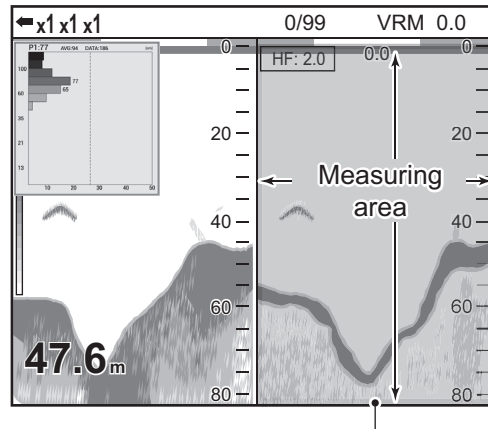

Measurement marker (yellow frame)

1.14.2 Measuring fish in a specific depth range

1. Press the **[2]** key several times to change the measuring mode to the [Specific Range] mode.

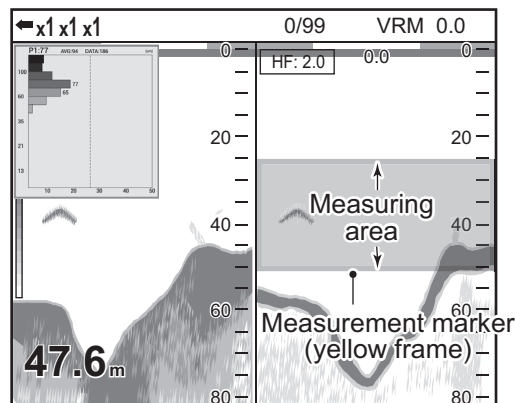

2. Confirm that the frame color of the fish size histogram is gray. If the frame color is orange, press the **[1]** key.
3. Move your finger across the touchpad to move the measuring marker.
4. Press the **[+]** or **[-]** key to adjust the measuring range. The **[+]** key increases the measuring range, and the **[-]** key decreases the measuring range.

1.14.3 Measuring bottom fish

1. Press the **[2]** key several times to select the [Bottom Trace] measuring mode.

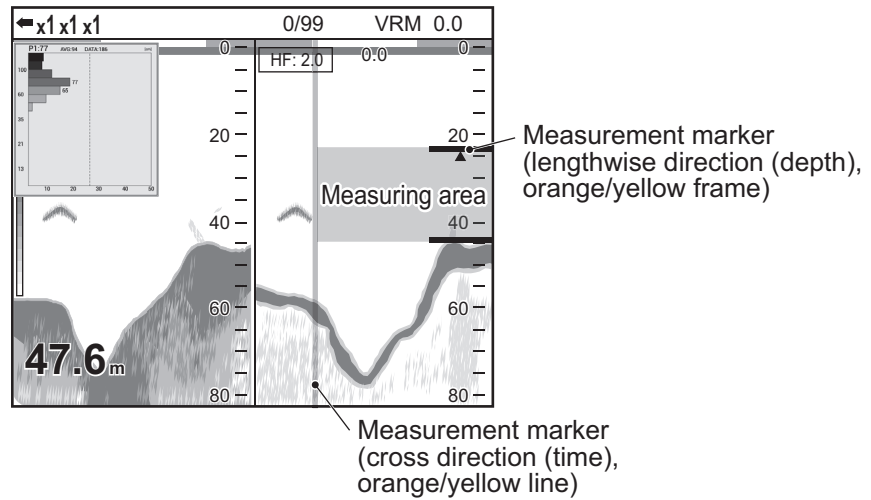

Note: When the depth value is not shown (“----”), the measuring marker does not appear in the [Bottom Trace] mode. In this time, measuring area is entire area.

2. Press the **[3]** key to select the setting direction (lengthwise direction (depth) or cross direction (time)).
The **[3]** key switches the setting direction between lengthwise direction (depth) and cross direction (time). The orange frame (line) indicates the direction available for setting with the **[▲]** or **[▼]** key.
3. Press the **[▲]** or **[▼]** key to adjust the measuring range.
The **[▲]** key increases the measuring range, and the **[▼]** key decreases the measuring range.

1.14.4 Measuring fish in a specific area

1. Press the **[2]** key several times to the [Specific Area] measuring mode.

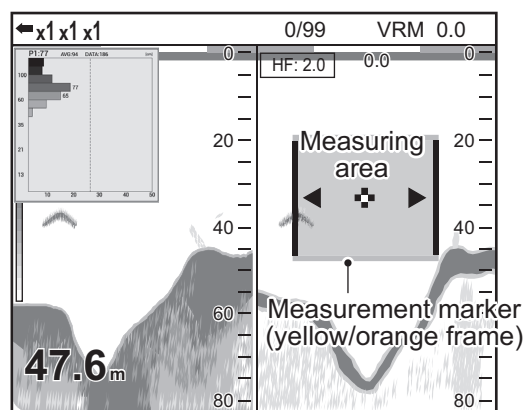

2. Confirm that the frame color of the fish size histogram is gray.
If the frame color is orange, press the **[1]** key.
3. Move your finger across the touchpad to move the measuring marker.

- Press the **3** key to select the setting direction (lengthwise direction (depth) or cross direction (time)).

The **3** key switches the setting direction between lengthwise direction (depth) and cross direction (time). The orange frame indicates the direction available for setting with the **▲** or **▼** key.

 : Lengthwise direction
(Orange: top and bottom, Yellow: left and right)

 : Cross direction
(Orange: left and right, Yellow: top and bottom)

- Press the **▲** or **▼** key to adjust the measuring range.
The **▲** key increases the measuring range, and the **▼** key decreases the measuring range.

1.15 Save and Replay a Screenshot

A maximum of 99 screenshots can be saved in the internal memory. You can replay a screenshot at any time. This feature improves your fishing by comparing fish finder echoes with your resulting catches.

1.15.1 How to save a screenshot

- Press the **📷/▶** key to save the screenshot.
The picture at the moment the key is pressed is saved in the internal memory (PNG file). The count of the screenshots appears at the top of the display.

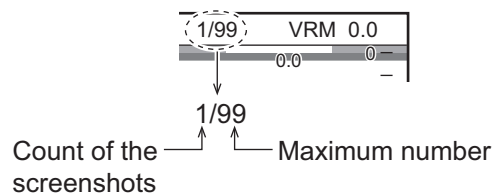

Note: When you try to save more than 99 screenshots, the message "Not enough memory to save screen. Delete unnecessary files." appears. In this situation, do one of the following:

- Delete unnecessary files (see section 1.15.3).
- Extract the screenshot files to a USB flash memory (see page 2-15).

1. OPERATION

1.15.2 How to replay a screenshot

1. Long press the / key to show the latest screenshot on the replay window.

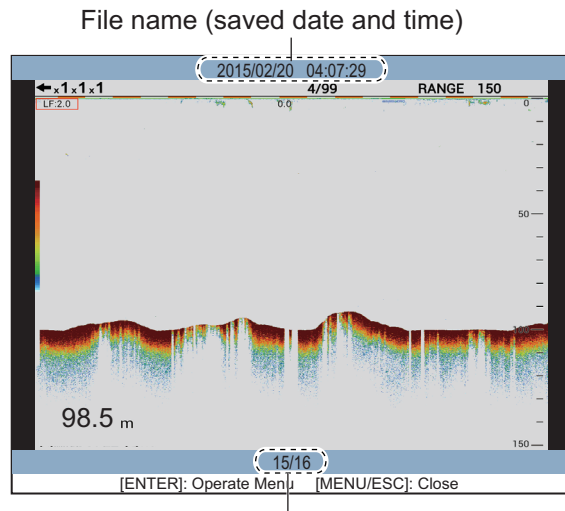

2. Rotate the **ENTER** knob to select the replay file.
To select the previous file, rotate the **ENTER** knob clockwise.
3. Press the **MENU/ESC** key to close the replay window.

1.15.3 How to delete a screenshot

You can delete individual or all screenshot files on the replay window.

How to delete a screenshot file

1. Long press the / key to open the replay window.
2. Rotate the **ENTER** knob to select the file to delete.
3. Push the **ENTER** knob to show the menu window.



Note: To abort the delete operation, press the **MENU/ESC** key.

4. Select [Delete], then push the **ENTER** knob.

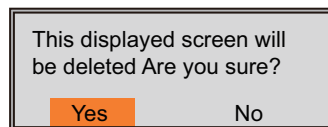

5. Select [Yes], then push the **ENTER** knob.
6. Press the **MENU/ESC** key to close the replay window.

How to delete all screenshot files

1. Long press the / key to open the replay window.
2. Push the **ENTER** knob to show the menu window.

3. Select [All Delete], then push the **ENTER** knob.

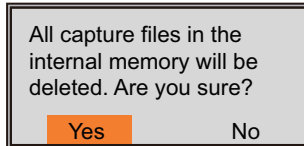

4. Select [Yes], then push the **ENTER** knob.
5. Press the **MENU/ESC** key to close the replay window.

1.16 Function Keys

The function keys (**F1** and **F2** key) provide one-touch display of a user-defined options window. For FCV-1900 and FCV-1900B, you can assign the function to the **1**, **2** or **3** key. The table below shows the functions available with each function key.

Key	Default setting	Function
F1	FCV-1900G: Graph Location* FCV-1900B and FCV-1900: Interference	Menu items on the [Setting] tab
F2	TVG	
1	Pic. Advance	No function, TVG, Pic. Advance, Color Erase, A-Scope, Interference, Clutter, White Edge, STC, Bottom Zone, Freq Control
2	A-Scope*	
3	Color Erase	

*: The default for these settings changes, depending on the side looking settings (F1: Interference, **2**: Clutter).

1.16.1 How to execute a program

1. For FCV-1900G, press the **F1** or **F2** key. For FCV-1900 and FCV-1900B, press the **F1**, **F2**, **1**, **2** or **3** key.

*Default setting for **F2** key*

2. Change setting as appropriate.

1.16.2 How to program the function keys

For F1 and F2 key

1. Long press the **F1** or **F2** key until the [FUNC] tab appears.

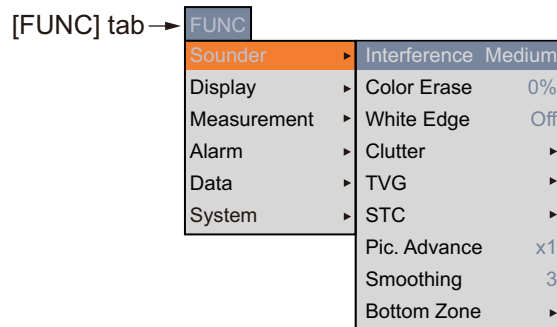

2. Select the item you want to program to the function key.
For menu items that can be programmed to a function key, see "MENU TREE" on page AP-1. When [Function Display] on the [Display] menu is set to [Key(F1/F2)], function names for **F1** and **F2** key appear at the bottom left of the display.

For **1**, **2** and **3** key

1. Long press the **1**, **2** or **3** key until the setting window appears.

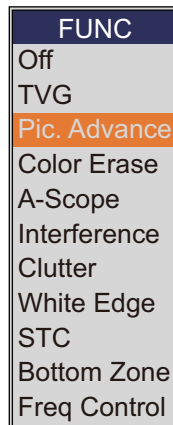

2. Select the item you want to program to the function key.
When [Function Display] on the [Display] menu is set to [Key(1/2/3)], function names for **1**, **2** and **3** key appear at the bottom left of the display.

1.17 Picture Advance Speed

The picture advance speed determines how quickly the vertical scan lines run across the screen. When setting a picture advance speed, keep in mind that a fast advance speed will expand echoes horizontally on the screen and a slow advance speed will contract them. A fast advance speed is useful for observing the rugged bottom closely. A slow advance speed is useful for observing the smooth bottom.

CAUTION

Neither the picture nor the depth indication is updated and when the picture is stopped. For those reasons, do not steer the vessel while monitoring the picture/depth indication when the picture is stopped.

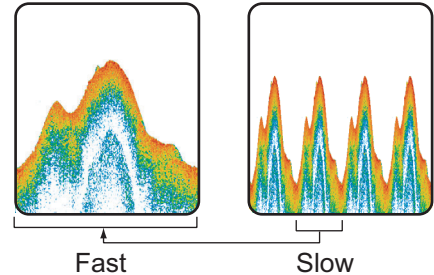

1. Press the **MENU/ESC** key, then open the [Setting], [External fish finder] or [Telesounder] tab.
2. Select [Sounder], then push the **ENTER** knob.

Setting	BBDS1	Telesounder
Sounder	▶	Interference Medium
Display	▶	Color Erase 0%
Measurement	▶	White Edge Off
Alarm	▶	Clutter ▶
Data	▶	TVG ▶
System	▶	STC ▶
		Pic. Advance x1
		Smoothing 3
		Bottom Zone ▶

3. Select [Pic. Advance], then push the **ENTER** knob.
4. Select the picture advance speed desired, then push the **ENTER** knob.

The fractions in the window indicate the number of scan lines produced per transmission. "1/16" is the slowest speed and "x4" is the fastest speed. "1/16" means one scan line is produced every sixteen transmissions. "Stop" freezes the display and is useful for taking a photo of the display. The current picture advance speed appears at the upper left side of the display.

Pic. Advance

- Stop
- 1/16
- 1/8
- 1/4
- 1/2
- x1
- x2
- x4

↑

Slow

↓

Fast

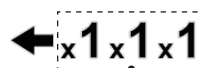

Picture advance speed
From left:
Internal fish finder,
external fish finder,
telesounder.

5. Press the **MENU/ESC** key several times to close the menu.

1.18 Rejecting Interference

Interference from other acoustic equipment operating nearby or other electronic equipment on your boat may show itself on the display as shown in the figure below. When this occurs use the interference rejector.

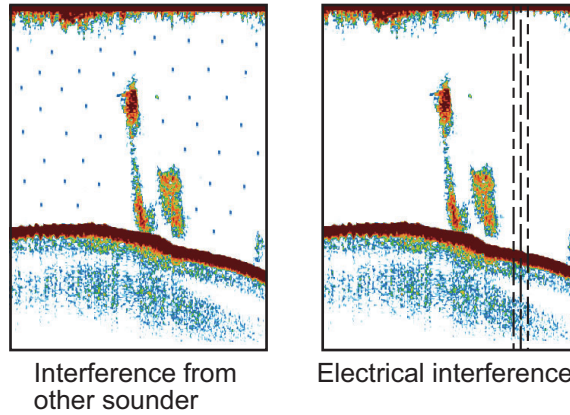

1. Press the **MENU/ESC** key, then open the [Setting] or [Telesounder] tab.
2. Select [Sounder], then push the **ENTER** knob.
3. Select [Interference], then push the **ENTER** knob.
4. Select the degree of interference reduction, then push the **ENTER** knob.
 - [Off]: Turn off the interference rejector.
 - [Low], [Medium], [High]: [High] provides the greatest degree of suppression and [Low] provides the weakest.
 - [Auto]: Automatically reject interference.
5. Press the **MENU/ESC** key several times to close the menu.



Note: Turn off the interference rejector when no interference exists, so as not to miss weak echoes from small targets.

1.19 Erasing Weak Echoes

Sediment in the water or reflections from plankton may be painted on the display in low intensity tones, as shown in the illustration below. You can remove these unwanted echoes with the color erase feature.

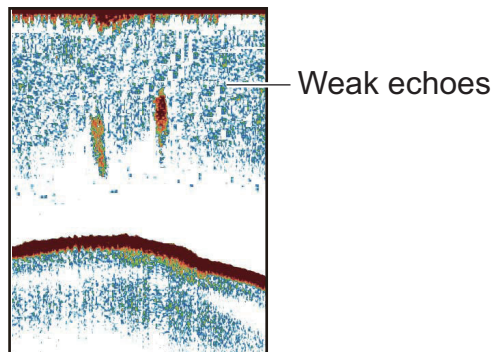

1. Press the **MENU/ESC** key, then open the [Setting], [External fish finder] or [Telesounder] tab.

2. Select [Sounder], then push the **ENTER** knob.
3. Select [Color Erase], then push the **ENTER** knob.
4. Select the color to erase, then push the **ENTER** knob.
The larger the setting value, the greater the number of colors the are erased.
5. Press the **MENU/ESC** key several times to close the menu.

Color Erase
0%
5%
10%
15%
20%
25%
30%
35%
40%
45%
50%

1.20 Rejecting Low Level Noise

Low intensity “speckles” may appear over most of screen. This is mainly due to sediment in the water or noise. These unwanted echoes can be rejected.

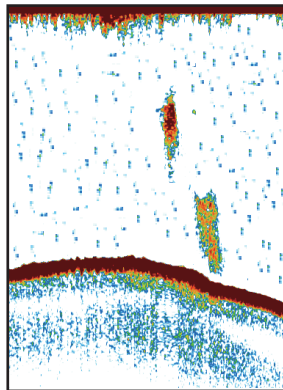

1. Press the **MENU/ESC** key, then open the [Setting], [External fish finder] or [Telesounder] tab.
2. Select [Sounder], then push the **ENTER** knob.
3. Select [Clutter], then push the **ENTER** knob.
For [Setting] and [Telesounder] tab, go to next step. For [External fish finder] tab, go to step 7.

Clutter	
HF Clutter	40%
HF Clutter Curve	Std
LF Clutter	40%
LF Clutter Curve	Std

For [Setting] and [Telesounder] tab

Clutter
0%
10%
20%
30%
40%
50%
60%
70%
80%
90%
100%

For [External fish finder] tab

4. Select [HF Clutter Curve] or [LF Clutter Curve] as applicable, then push the **ENTER** knob.

1. OPERATION

5. Select [Std] or [Linear], then push the **ENTER** knob.
 - [Std]: Strong color echoes are displayed as is and weak color echoes are shown smaller, when the clutter level setting is raised.
 - [Linear]: All echoes are displayed smaller, when the clutter level setting is raised.
6. Select [HF Clutter] or [LF Clutter] as applicable, then push the **ENTER** knob.
7. Select the clutter level, then push the **ENTER** knob.
The larger the setting, the greater the degree of clutter rejection.
8. Press the **MENU/ESC** key several times to close the menu.

1.21 Adjusting TVG

A school of fish at a deep depth is displayed in weak colors even if it is equal in strength to one in shallow waters. This is due to propagation attenuation of the ultrasonic wave. To compensate for this difference, use TVG. TVG automatically adjusts the gain with depth so that echoes of the same strength and different depths are shown in the same colors regardless of their depths. The gain is increased with depth to display echoes of equal strengths in the same colors. In the figure below, for example, the TVG is set for 100 m and the TVG level is adjusted. Then, unwanted echoes at a distance less than 100 m are deleted and echoes at depths greater than 100 m are not affected.

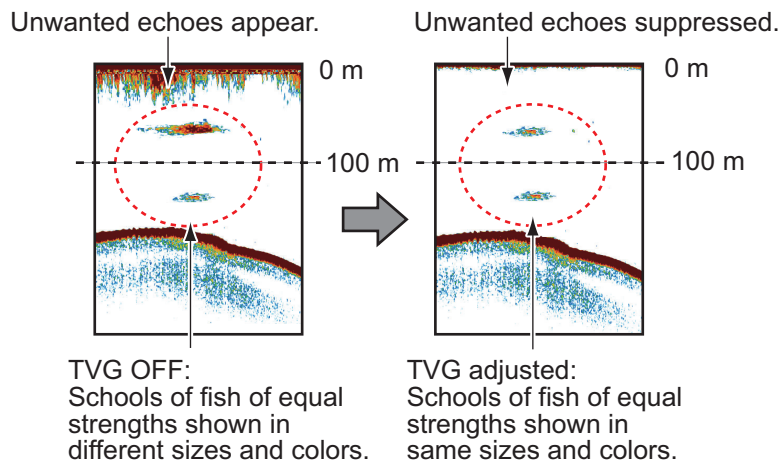

1. Press the **MENU/ESC** key, then open the [Setting], [External fish finder] or [Telesounder] tab.
2. Select [Sounder], then push the **ENTER** knob.
3. Select [TVG], then push the **ENTER** knob.
For [Setting] and [Telesounder] tab, go to next step. For [External fish finder] tab, go to step 6.

TVG	
HF TVG Level	3
HF TVG Distance	600ft
LF TVF Level	3
LF TVG Distance	600ft

TVG	
HF TVG Level	5
LF TVF Level	5

4. Select [HF TVG Distance] or [LF TVG Distance] as applicable, then push the **ENTER** knob.

0 6 0 0
(100 ~ 3000ft)

5. Select a suitable value, then push the **ENTER** knob.
6. Select [HF TVG Level] or [LF TVG Level] as applicable, then push the **ENTER** knob.
7. Select the TVG level, then push the **ENTER** knob.
The higher the level the less the gain at near distance.
Note: For the [Telesounder] tab, set [HF TVG Level] and [LF TVG Level] to "0" to use the telesounder when FCV-1900/B/G is installed on the mother ship and FCV-1200L is installed on the sister ship.
8. Press the **MENU/ESC** key several times to close the menu.

1.22 A-scope Display

This display shows echoes at each transmission with amplitudes and tone proportional to their intensities, on the right side of the screen. It is useful for estimating the species of a school of fish and bottom composition.

Note 1: In the horizontal split dual frequency display the A-scope display appears on both high and low frequency displays. In the vertical split dual frequency display the A-scope display only appears on the high frequency display.

Note 2: The A-scope display is unavailable depending on the side looking setting (see page 1-10).

1. Press the **MENU/ESC** key, then open the [Setting] tab.
2. Select [Display], then push the **ENTER** knob.

Setting	BBDS1	Telesounder
Sounder	▶	A-Scope Off
Display	▶	Temp Graph Off
Measurement	▶	Temp Color Std
Alarm	▶	Display Division <input type="checkbox"/>
Data	▶	Window Size 1:1
System	▶	Zoom Mode Bottom Lock
		Zoom Marker On
		Colors 64
		Hue Std
		Back Ground Dark Blue
		Window Color Day
		Depth Size Normal
		Depth Scale Right
		Distance Scale Top
		Color Bar On
		Function Display Key(F1/F2)
		Mode&Gain Setting On

3. Select [A-Scope], then push the **ENTER** knob.
4. Select the A-scope presentation desired, then push the **ENTER** knob.
 - [Off]: The A-scope is not shown.
 - [Normal]: Display shows echoes at each transmission with amplitudes and tone proportional to their intensities.
 - [Peak]: "Normal" A-scope display plus peak-hold amplitude echo in dots for last five seconds.
5. Press the **MENU/ESC** key several times to close the menu.

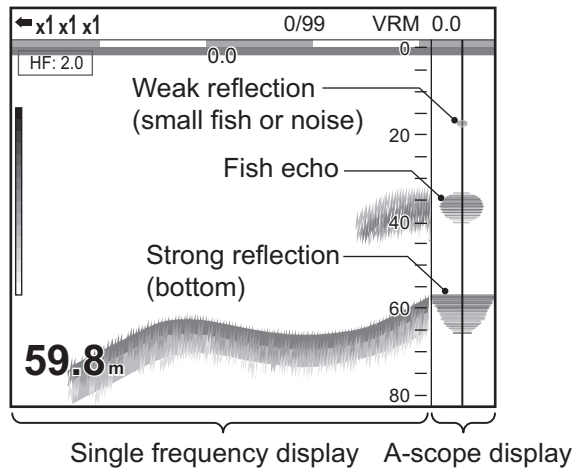

1.23 Fish Information (ACCU-FISH™)

The ACCU-FISH™ feature measures the length of individual fish and tags the fish with a fish symbol whose size is proportional to the length of the fish. The length or depth of the fish can be indicated digitally.

Notice for the ACCU-FISH™ feature

- This feature requires an appropriate transducer. For the transducer compatible with this feature, see "EQUIPMENT LISTS" on the installation manual (IME-23860).
- For FCV-1900G, close the fish size histogram window to use the ACCU-FISH™.
- The fish length calculated by this fish finder is intended for reference purposes; it is not a completely accurate measurement of fish length.
- The echo strength of a school of fish changes according to the fish. When the size shown on the fish size histogram differs from the actual size, adjust [Fish Size] on the [Calib] menu to compensate for the difference (see page 2-9).
- A fish whose depth is shallower than 2 m can not be measured. Also, the maximum range depends on the transducer's performance, installation location, and seastate. If the [Zero Line Rejection] on the [Calib] menu is turned on, the fish whose depth is shallower than the transmission line can not be measured.
- This feature cannot be used with the inside-hull transducer since a fish may not be detected depending on the transducer's frequency. Even if a fish is detected, the fish length indicated may be smaller than actual length.
- In case of a school of fish, echoes overlap one another, so the margin of error will be greater.
- The TX pulse length changes according to ACCU-FISH™ On/Off state. This causes a difference in both sensitivity and the echoes viewed.

1.23.1 How to activate ACCU-FISH™

Activate the ACCU-FISH™ to show the information of the fish.

Note: The ACCU-FISH™ is unavailable depending on side looking mode (see page 1-10).

1. Press the **MENU/ESC** key, then open the [Setting] or [External fish finder] tab.
2. Select [Measurement], then push the **ENTER** knob.

Setting	BBDS1	Telesounder
Sounder	▶	ACCU-FISH Graph
Display	▶	Measure Area Std
Measurement	▶	[Graph Display]
Alarm	▶	Graph Style Horizontal
Data	▶	Graph Size Small
System	▶	Graph Location Upper Left
		Graph Scale End 39inch
		Distributed Scale Start 3%
		Distributed Scale End 50%
		Number of graph bars Max.16 bars
		Transparency Off
		Updating Cycle 3s
		Area Marker Single Display
		[Mark Display]
		Fish Info Size
		Fish Symbols Fish Mark

Setting	BBDS1	Telesounder
Sounder	▶	ACCU-FISH On
Display	▶	
Measurement	▶	
System	▶	

For [External fish finder] tab

For [Setting] tab

3. Select [ACCU-FISH], then push the **ENTER** knob.
4. Select [Symbol] ([Setting] tab) or [On] ([External fish finder] tab), then push the **ENTER** knob.
For the [Setting] tab, the menu items below [Mark Display] become active after activating the ACCU-FISH™.
5. Press the **MENU/ESC** key several times to close the menu.

Note: To hide the fish symbol, select [Off] at step 4. When [ACCU-FISH] is changed to [Off] or [Graph], all data measured for it is deleted.

1.23.2 Fish symbols

There are two types of fish symbols:  ,  . The fish symbols are shown on the following displays.

- High frequency screen on the dual frequency display.
- High frequency screen or external fish finder screen on the user display.

1. Press the **MENU/ESC** key, then open the [Setting] tab.
2. Select [Measurement], then push the **ENTER** knob.
3. Select [Fish Symbols], then push the **ENTER** knob.
4. Select [Fish Mark] or [Point Mark], then push the **ENTER** knob.

You can show the fish information figure alone (without fish symbol) by turning off [Fish Symbols].



5. Press the **MENU/ESC** key several times to close the menu.

1.23.3 Displaying fish info

1. Press the **MENU/ESC** key, then open the [Setting] tab.
2. Select [Measurement], then push the **ENTER** knob.
3. Select [Fish Symbols], then push the **ENTER** knob.
4. Select [Fish Size] or [Depth], then push the **ENTER** knob.

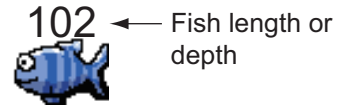

Note: You can show the fish information figure alone (without fish symbol) by turning off [Fish Symbols].

5. Press the **MENU/ESC** key several times to close the menu.

1.24 Alarms

This fish finder has five alarms: bottom alarm, normal fish alarm (entire area or specific area), bottom lock fish alarm, water temperature alarm, and fish size alarm. When the conditions of an alarm are met, the audio alarm sounds and the alarm icon (flashing) appears at the top of the display. The alarm icon remains on the screen until the cause of the alarm is removed or the alarm is disabled.

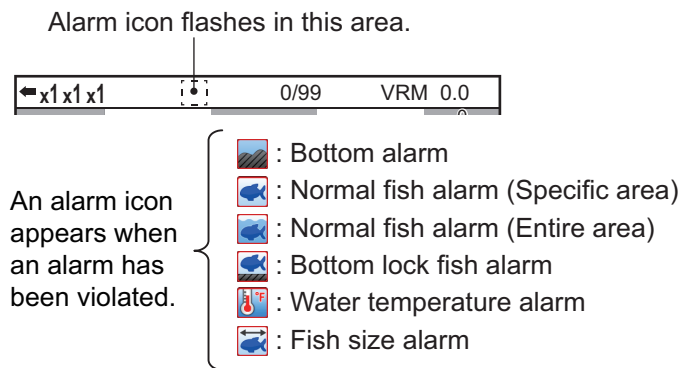

Bottom alarm*: The bottom alarm alerts you when the bottom (displayed in red or red-dish brown echo) is within the alarm range set. To activate the bottom alarm the depth must be displayed.

Normal fish alarm*: The normal fish alarm tells you when an echo above a certain strength (selectable) is within the preset alarm range.

Bottom lock fish alarm*: The bottom lock fish alarm sounds when fish are within a certain distance from the bottom. Note that the bottom lock and bottom discrimination (1/2 or 1/3) displays must be turned on to use this alarm.

Water temperature alarm: The water temperature alarm alerts you when the water temperature is within (inside alarm) the alarm range set or under/over (outside alarm) the range set. This alarm requires water temperature data.

Fish size alarm*: The fish size alarm alerts you when a fish of the specified length is in the alarm zone. Available when the ACCU-FISH™ is active.

*: Unavailable depending on the side looking setting (see page 1-10).

How to activate an alarm

1. Press the **MENU/ESC** key, then open the [Setting] tab.
2. Select [Alarm], then push the **ENTER** knob.

Setting	BBDS1	Telesounder
Sounder	▶	Bottom Off
Display	▶	From 0ft }*
Measurement	▶	Span 10ft }*
Alarm	▶	Fish (Normal) Off
Data	▶	From 0ft }*
System	▶	Span 0ft }*
		Fish (B/L) Off
		From 0.0ft }*
		Span 0.1ft }*
		Fish Level Medium
		Temperature Off
		From 65.0°F }*
		Span 1.0°F }*
		Fish Size Off
		From 4inch }*
		Span 12inch }*

*: Operable when corresponding alarm is activated.

3. Select [Bottom], [Fish (Normal)], [Fish (B/L)], [Temperature] or [Fish Size], then push the **ENTER** knob.



[Bottom], [Fish (B/L)] or [Fish Size] is selected.

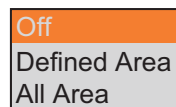

[Fish (Normal)] is selected.



[Temperature] is selected.

4. Do one of the following according to the item selected at step 3.
[Bottom] (bottom alarm)

- 1) Select [On], then push the **ENTER** knob.

The alarm marker (greenish yellow) appears at the starting point for the alarm.

- 2) Select [From], then push the **ENTER** knob.

- 3) Set the starting depth (distance from the bottom of the transducer), then push the **ENTER** knob.

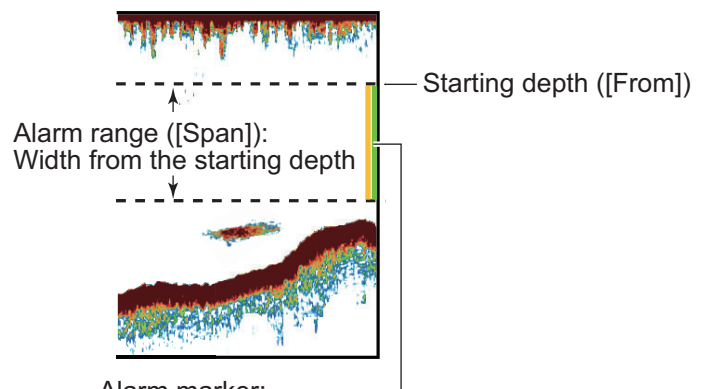
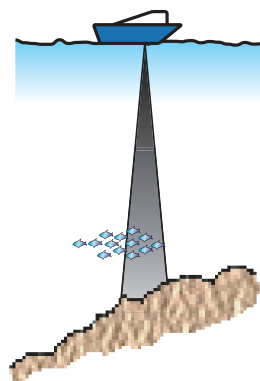

- Bottom and normal fish alarm: Right side
- Bottom lock fish alarm: Center

- 4) Select [Span], then push the **ENTER** knob.

1. OPERATION

- 5) Set the alarm range (width from the starting depth), then push the **ENTER** knob.

[Fish (Normal)] (normal fish alarm) and [Fish (B/L)] (bottom lock fish alarm)

- 1) For [Fish (Normal)], select [Defined Area] or [All Area], then push the **ENTER** knob. For [Fish (B/L)], select [On], then push the **ENTER** knob.
For [Defined Area] or [On], the alarm marker (yellow) appears at the starting point for the alarm. Go to the next step. For [All Area], the alarm marker appears at the left of the depth scale. Go to step step 6.
- 2) Select [From], then push the **ENTER** knob.
- 3) Set the starting depth, then push the **ENTER** knob.
 - For the normal fish alarm: Distance from the bottom of the transducer.
 - For the bottom lock alarm: Distance from the bottom.
- 4) Select [Span], then push the **ENTER** knob.
- 5) Set the alarm range (width from the starting depth), then push the **ENTER** knob.
- 6) Select [Fish Level], then push the **ENTER** knob.
- 7) Select the echo strength that triggers the alarm, then push the **ENTER** knob.
 - [Weak]: Echoes stronger than lightblue trigger the alarm.
 - [Medium]: Echoes stronger than yellow trigger the alarm.
 - [Strong]: Echoes stronger than red trigger the alarm.

[Temperature] (water temperature alarm)

- 1) Select [Inside] or [Outside], then push the **ENTER** knob.
- 2) Select [From], then push the **ENTER** knob.
- 3) Set the starting temperature for the alarm, then push the **ENTER** knob.
- 4) Select [Span], then push the **ENTER** knob.
- 5) Set the width for the alarm, then push the **ENTER** knob.

[Fish Size] (fish size alarm)

- 1) Select [On], then push the **ENTER** knob.
 - 2) Select [From], then push the **ENTER** knob.
 - 3) Set the minimum fish length, then push the **ENTER** knob.
 - 4) Select [Span], then push the **ENTER** knob.
 - 5) Set the width for the alarm, then push the **ENTER** knob.
5. Press the **MENU/ESC** key several times to close the menu.

Note: To disable an alarm, select [Off] at step 4 in the applicable procedure above.

1.25 Sonde Mark and V-Temperature Graph

With connection of a net sonde, you can show the sonde mark and V-temperature graph.

1.25.1 How to show the sonde mark

A sonde mark shows the depth of the net sonde transmitter. A maximum of six sonde marks can be shown on the display. The color and mark width of the sonde mark can be customized. The line type (marker pattern) of the sonde marker depends on the input method:

- Digital input (CIF): The sonde mark is shown with the dotted line.
- Analog input: The line type depends on the setting of a net sonde.

Note 1: A maximum of three net sondes can be connected to the processor unit. One net sonde can output three sonde marks. When seven or more sonde mark information is input to the processor unit, six sonde marks are shown in order of the depth.

Note 2: The sonde mark is unavailable depending on the side looking setting (see page 1-10).

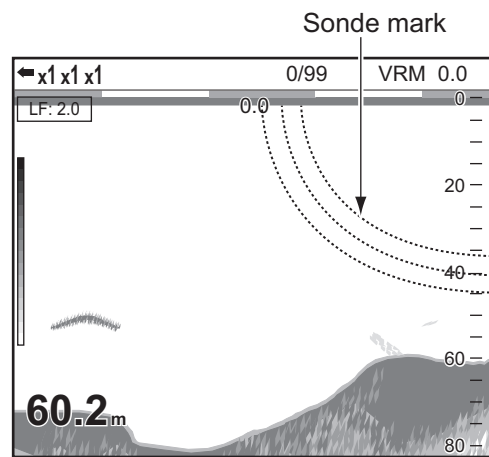

Display example
(when three sonde marks are displayed)

Note 3: This function is available only for the internal fish finder. Not for telesounder screen.

Note 4: The sonde mark display on the telesounder screen depends on the settings of a fish finder for a consort ship.

1. OPERATION

1. Press the **MENU/ESC** key, then open the [Setting] tab.
2. Select [Data], then push the **ENTER** knob.

Setting	BBDS1	Telesounder
Sounder	▶	Position Off
Display	▶	Date Time Off
Measurement	▶	Speed (SOG) Off
Alarm	▶	Speed (STW) Off
Data	▶	Temp Off
System	▶	Temp Source NMEA
		[Sonde Mark]
		Sonde Mark Display Off
		Mark Color Red
		Width of Mark 1
		[Sonde Graph]
		Sonde Graph Off
		Graph Reset

3. Select [Sonde Mark Display], then push the **ENTER** knob.
4. Select [LF] or [HF], then push the **ENTER** knob.
 - LF: Show the sonde mark on the low frequency display.
 - HF: Show the sonde mark on the high frequency display.
5. Select [Mark Color], then push the **ENTER** knob.
6. Set the color desired, then push the **ENTER** knob. The display color can be customized, from RGB 0 to 63.

Position	Off
Date Time	Off
Speed (SOG)	Off
Speed (STW)	Off
Temp	Off
Temp Source	NMEA
[Sonde Mark]	
Sonde Mark Display	Off
Mark Color	Red
Width of Mark	1
[Sonde Graph]	
Sonde Graph	Off
Graph Reset	

Mark Color	
CH0	Red
CH1	White
CH2	Green
CH3	Cyan
CH4	Purple
CH5	White
Default	

RGB	
Red	59
Green	0
Blue	0

Note: For digital input (CIF), the display color for each sonde mark (max. 6 CH) can be separately assigned, from RGB 0 to 63. For analog input, the color selected for CH0 is globally assigned to all channels.

7. Set the color desired, then push the **ENTER** knob.
8. Select [Width of Mark], then push the **ENTER** knob.
9. Set the line width, then push the **ENTER** knob.
The greater the value the thicker the line width.
10. Press the **MENU/ESC** key several times to close the menu.

Note: To hide the sonde mark, select [Off] at step 4.

1.25.2 How to show the V-temperature graph

The V-temperature graph plots depth and water temperature data fed from the net sonde. Do the following to show the V-temperature graph.

Note: The V-temperature graph is unavailable depending on the side looking setting (see page 1-10).

1. Press the **MENU/ESC** key, then open the [Setting] tab.
2. Select [Data], then push the **ENTER** knob.
3. Select [Sonde Graph], then push the **ENTER** knob.
4. Select [On], then push the **ENTER** knob.

The V-temperature graph window appears at the left of the display. The graph plots depth and water temperature data fed from the No.1 net sonde transmitter in red. Water temperature is plotted on the horizontal axis; depth on the vertical axis. The graph scale for the vertical axis changes according to the display range. When the latest water temperature data exceeds the graph scale of the horizontal axis, the scale changes automatically. The depth and temperature units used for the V-temperature graph are fixed to meters and °C.

5. Press the **MENU/ESC** key several times to close the menu.

Note 1: To close the V-temperature graph window, select [Off] at step 4.

Note 2: You can refresh the V-temperature graph with [Graph Reset] on the Data menu. After refreshing the graph, the scale and plot data are deleted, then plotting of the data is restarted.

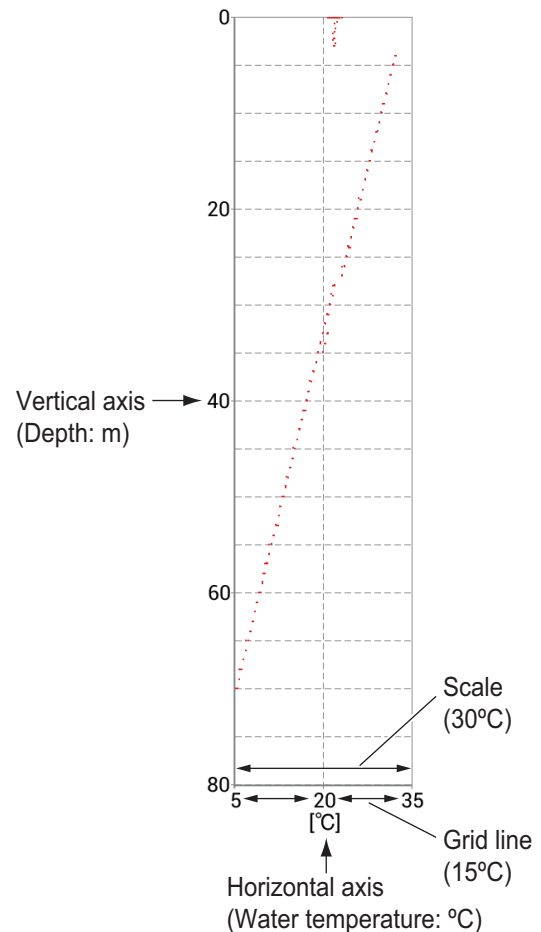

1.26 Bottom Discrimination Display

The bottom discrimination display analyzes the bottom echo to categorize bottom hardness in one of four types (rocks, gravel, sand, mud) and shows the results in a colorful graphic display. This function requires Bottom Discrimination Sounder BBDS1.

There are three bottom discrimination displays: graphic, four colors, and probability.

- **Graphic display:** The most probable bottom material (mud, sand, gravel, rock) is indicated graphically.

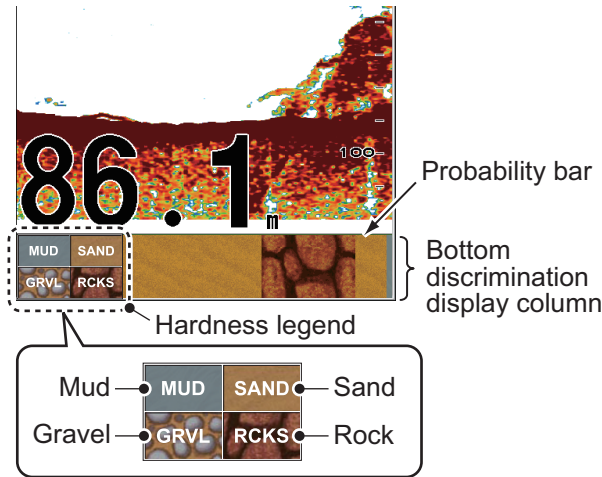

Probability bar:
Degree of trust for bottom discrimination display
(Green, Normal; Yellow, Caution; Background color, Abnormal)

- **Four colors display:** The most probable bottom material (mud, sand, gravel, rock) is indicated with four colors.

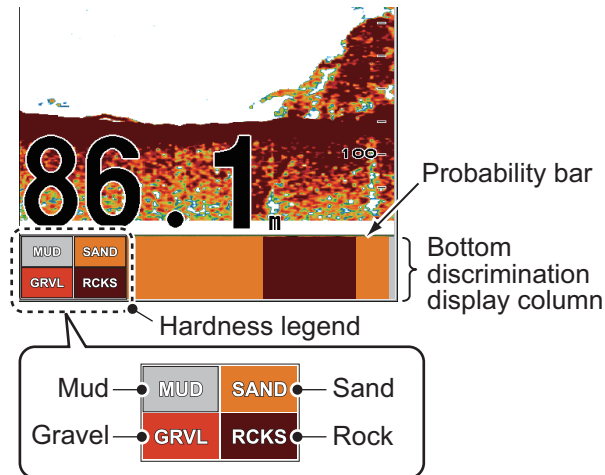

- **Probability display:** The most probable bottom material is indicated in proportion.

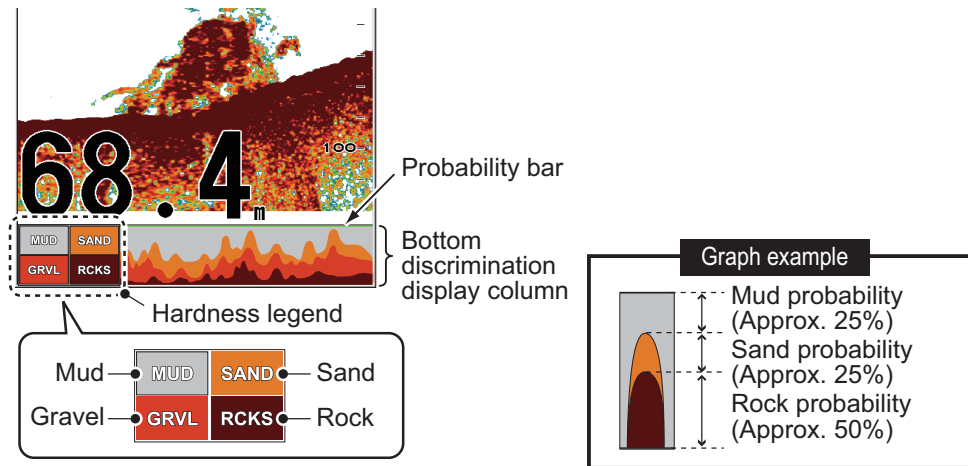

Characteristics of the bottom discrimination display

- The bottom discrimination display provides an estimate of bottom composition. Actual composition may be different.
- Operating environment:
 - Depth: 5 to 100 m (16 to 328 ft)
 - Speed: 10 kn or less
- This feature uses the range from the ship's draft; therefore, enter the ship's draft (see page 2-12).
- Be sure that the transducer is mounted straight. Otherwise the bottom discrimination display may not function accurately.

How to activate the bottom discrimination display

Note 1: When bottom discrimination display is active, the **RANGE** and **SHIFT** keys are inoperative and split range, auto range and shift range mode are deactivated.

Note 2: The bottom discrimination display is unavailable when side looking mode is active.

1. Press the **MENU/ESC** key, then open the [BBDS1] tab.

2. Select [Display], then push the **ENTER** knob.

3. Select [Bottom Discrim], then push the **ENTER** knob.

Setting	BBDS1	Telesounder
Sounder		▶ Bottom Discrim Probability
Display		▶ Legend On
Measurement		▶
System		▶

4. Select [Graphic], [4 colors] or [Probability], then push the **ENTER** knob.

The category of the bottom hardness is shown for screen of the external fish finder.

5. Select [Legend], then push the **ENTER** knob.

6. Select [On] or [Off] to show or hide the hardness legend (at the bottom of the display), then push the **ENTER** knob.

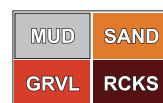

Legend for [Graphic] Legend for [4 colors] and [Probability]

7. Press the **MENU/ESC** key several times to close the menu.

Note: To turn off the bottom discrimination display, select Off at step 4.

1.27 Menu Description

This section describes menu items not previously mentioned. For the System menu, see chapter 2.

1.27.1 [Sounder] menu

Interference	Medium
Color Erase	0%
White Edge*	Off
Clutter	▶
TVG	▶
STC	▶
Pic. Advance	x1
Smoothing	3
Bottom Zone*	▶

For [Setting] tab

*: Not available depending on the side looking setting (see page 1-10).

Color Erase	0%
Clutter	0%
TVG	▶
STC	▶
Pic. Advance	x1
Smoothing	3

For [External fish finder] tab

Interference	Off
Color Erase	0%
Clutter	▶
TVG	▶
STC	▶
Pic. Advance	x1
Smoothing	3

For [Telesounder] tab

[White Edge]: The white edge feature displays the leading edge of the bottom echo in white to help you distinguish bottom fish from the bottom echo.

- 1) Select [Bottom Zone], then push the **ENTER** knob.
- 2) Select the value, then push the **ENTER** knob.

The larger the value the greater the width. To turn off the white edge, select [Off].

White Edge
Off
1
2
3
4
5
6
7
8
9
10

[STC]: Delete unwanted echoes (plankton, air bubbles, etc.) near the surface. This is useful to clear the surface of unwanted echoes to look for surface fish. The larger the value the more surface echoes are erased. In setting 10, STC deletes unwanted echoes from the surface to about 16 ft. Avoid setting the STC too high; fish echoes near the surface may be erased.

STC
HF STC 0
LF STC 0

[Smoothing]: If echoes appear like “patchwork,” turn this feature on to smooth them. The more the setting value, the more this feature works. This feature is effective to reduce screen flickers at night.

[Bottom Zone]: When the auto range mode is active, the range is automatically changed to keep the bottom echo in the specified area. When the auto shift mode is active, the range shift is automatically adjusted to keep the bottom echo in the specified area. This menu item sets the area where to display the bottom echo when the auto range or auto shift mode is active.

Note: This menu item is operative when [Auto Range] or [Auto Shift] is selected on the [Auto] menu.

- 1) Select [Bottom Zone], then push the **ENTER** knob.
- 2) Select [Above] or [Below], then push the **ENTER** knob.
- 3) Adjust the boundary line, then push the **ENTER** knob.

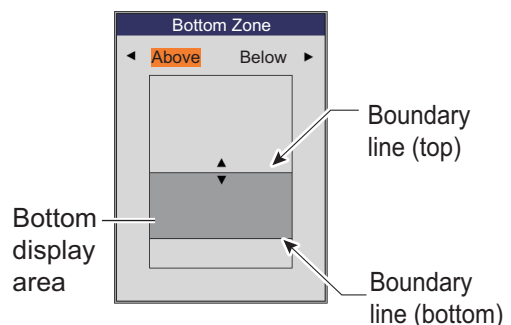

1.27.2 [Display] menu

A-Scope*	Off
Temp Graph	Off
Temp Color	Std
Display Division*	<input type="checkbox"/>
Window Size*	1:1
Zoom Mode	Bottom Lock
Zoom Marker*	On
Colors	64
Hue	Std
Back Ground	Dark Blue
Window Color	Day
Depth Size*	Normal
Depth Scale	Right
Distance Scale	Top
Color Bar	On
Function Display	Key(F1/F2)
Mode&Gain Display	On
Data Position	Upper Left

*: Not available depending on the side looking setting (see page 1-10).

For [Setting] tab

[Temp Graph]: Turn the temperature graph on or off and select graph scale, from [Narrow], [Normal] or [Wide]. [Narrow] is 16 °F, [Normal] is 24 °F and [Wide] is 32 °F.

[Temp Graph Color]: Select water temperature graph color. The default color is light-blue.

[Display Division]: Select display division in dual frequency and combination displays (zoom+normal). The choices are (vertical split) or (horizontal split).

[Window Size]: Select the division ration of the display in the dual frequency and combination displays (zoom+normal).

[Zoom Mode]: Select the zoom mode for the zoom display. For the description of each zoom mode, see section 1.4.3.

[Zoom Marker]: Turn the zoom marker on or off on the zoom displays.

[Colors]: Select the number of colors to display.

[Hue]: Change the color arrangement of the echo image. For how to change the user color setting, see page 2-2.

[Background]: Change the background to suit your current environment. This feature is inoperative when [Hue] is selected to [Custom].

[Window Color]: Select the background color for the menu window. [Day] is white background. [Night] is black background.

[Depth Size]: Change the size of the depth indication. When [Off] is selected, the depth indication is turned off.

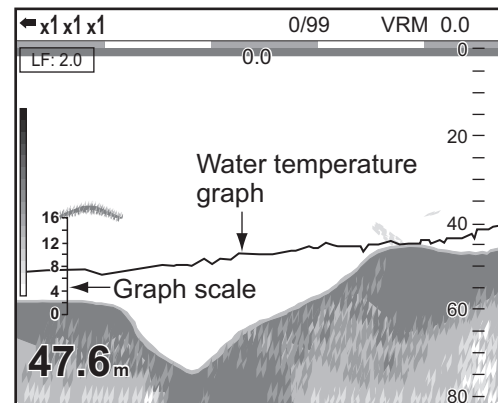

1. OPERATION

[Depth Scale]: Select where to display the depth scale. When [Off] is selected, the depth scale is turned off.

[Color Bar]: Turn the color bar on or off.

[Function Display]: Turn the function name for the function keys on or off.

[Key(F1/F2)]: The function names of the F1 and F2 key appear at the bottom left side of the display.

[Key(1/2/3)]: The function names of the **1**, **2** and **3** key appear at the bottom left side of the display.

[Mode&Gain Display]: Turn the mode and gain indication (example: **HF:2.0**) at the upper left side of the display on or off.

[Data Position]: Select the position for the data display, among [Upper Left], [Lower Left], [Upper Right], and [Lower Right].

1.27.3 [Measurement] menu

ACCU-FISH	Graph
Measure Area	Std
[Graph Display]	
Graph Style	Horizontal
Graph Size	Small
Graph Location	Upper Left
Graph Scale End	39inch
Distributed Scale Start	3%
Distributed Scale End	50%
Number of graph bars	Max.16 bars
Transparency	Off
Updating Cycle	3s
Area Marker	Single Display
[Mark Display]	
Fish Info	Size
Fish Symbols	Fish Mark

For [Setting] tab ([ACCU-FISH] = [Graph])

Note 1: The [Measurement] menu may not be available depending on the side looking setting (see page 1-10).

Note 2: [Measure Area] permits measurement of fish length at other than the seabed.

[Measure Area]: Set whether the fish length measurement is carried out at the seabed or all depths. The choices are [Std] (Standard) and [All Area].

[Graph Size]: Select the size of the fish size histogram window.

[Graph Scale End]: Select the fish size scale for the fish size histogram.

[Distributed Scale Start]: Select the starting value for the graph.

[Distributed Scale End]:Select the end value for the graph.

[Number of graph bars]: Select the number of graph bars on the fish size histogram. For example, [Max. 8 bars] shows eight graph bars in decreasing distribution quantity order.

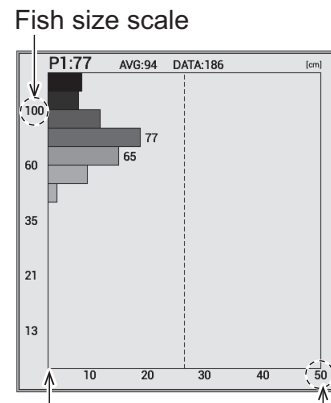

Starting value for the distribution End value for the distribution

Note: For [Max. 4 bars] and [Max. 8 bars], more than four or eight bars appear when the measured distribution quantity is equal between measured fish sizes.

[Transparency]: Select the degree of transparency for the fish size histogram window. The transparency effect is not applied to the graph bar, scale and characters. Alpha blending technology is used for transparency effects.

[Updating Cycle]: Select the updating cycle for the fish size histogram.

[Area Marker]: Select how to display the area marker.

[Single Display]: Single display only.

[Multi Display]. Show on both left and right displays.

1.27.4 [Data] menu

The [Data] menu sets up data received from external equipment.

Position	Off
Date Time	Off
Speed (SOG)	Off
Speed (STW)	Off
Temp	Off
Temp Source	NMEA
[Sonde Mark]	
Sonde Mark Display*	Off
Mark Color	Red
Width of Mark	1
[Sonde Graph]	
Sonde Graph*	Off
Graph Reset	

*: Not available depending on the side looking setting (see page 1-10).

For [Setting] tab

[Position], [Speed (SOG)], [Speed (STW)], [Temp]: Select [On] to show the data fed from the sensor on the display. Requires appropriate sensors.

1. OPERATION

Note: When the data is not being received, the applicable indication is shown with "--".

35°05.7004 N ← Own ship's position
135°45.2787 E
UTC 12:20:20 ← Date and Time
2016/11/01 (When [UTC] is selected)
15.4 kn SOG ← Speed over ground
11.6 kn STW ← Speed through water
32.9 °F ← Water temperature

Display example

[Date Time]: Select the display format for date and time.

[UTC]: Shows the UTC time and date.

[Local]: Shows the local time and date.

The ZDA sentence is required to display date and time. When you select [Local], enter the time difference between UTC and local time (see page 2-13).

Note: When the ZDA sentence is not input, the date and time indication is shown with "--".

[Temp Source]: Select the data source for water temperature data.

[NMEA]: Navigation equipment connected to the processor unit.

[Own Temp Sensor]: Temperature sensor connected to the processor unit.

[Own XDCR]: Transducer connected to the processor unit.

[External Temp Sensor]*: Temperature sensor connected to the external fish finder.

[External XDCR]*: Transducer connected to the external fish finder.

*: Requires external fish finder.

2. SYSTEM MENU

2.1 How to Open the [System] Menu

The [System] menu mainly consists of items which do not require regular adjustment.

1. Press the **MENU/ESC** key, then open the [Setting] or [External fish finder] tab.
2. Select [System], then push the **ENTER** knob.
For details of the [Test] menu, see section 3.6 and section 3.7.

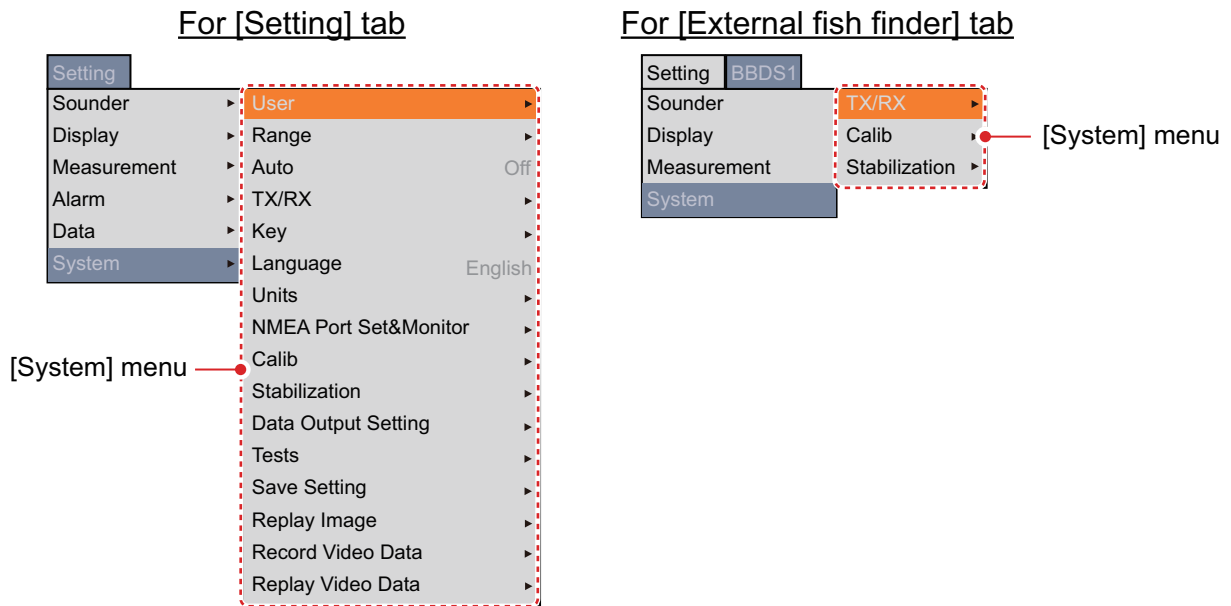

Note: For the [Telesounder] tab, the [System] menu is not shown. However, the [Calib] menu on the [Telesounder] tab is similar to the [Calib] menu in the [System] menu. For details of the [Calib] menu, see section 2.10.

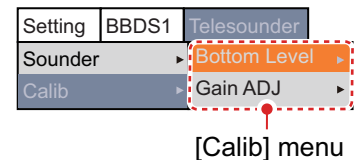

2.2 [User] Menu

The [User] menu mainly provides items for arrangement of the user mode display.

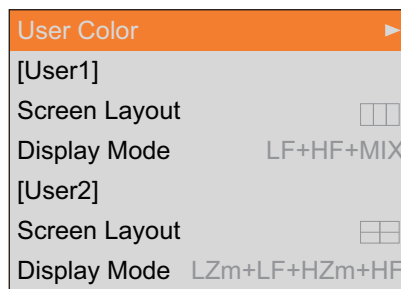

[User Color]: Arrange the display colors to your liking by changing the color arrangement on the color bar. For how to change the setting, see the next page.

2. SYSTEM MENU

How to change the user color

- 1) Select [User Color] and press the **ENTER** knob to show the user color bar.

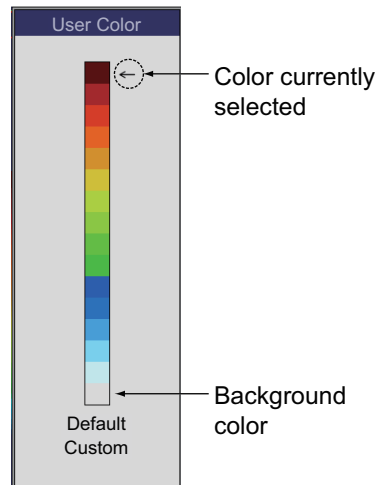

- 2) Rotate the **ENTER** knob to select the color to adjust, then press the knob.

The [RGB] adjustment window appears.

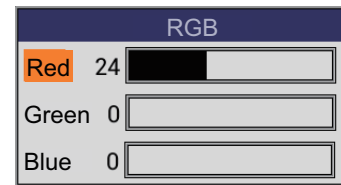

- 3) Rotate the **ENTER** knob to select the color ([Red], [Green], or [Blue]) to adjust, then press the knob.

- 4) Rotate the **ENTER** knob to adjust color, then press the knob.

The color of the color bar on the [User Color] window changes.

- 5) Repeat step 3 and step 4 for the three [Red], [Green] and [Blue] colors.

- 6) Press the **MENU/ESC** key.

- 7) If you want to change other color, repeat step 2 to step 6.

- 8) Select [Custom], then push the **ENTER** knob to apply the customized user color.

- 9) Select [Yes], then push the **ENTER** knob.

The setting for [Hue] on the [Display] menu changes to [Custom]. In this time, [Back Ground] is inoperative.

- 10) Press the **MENU/ESC** key to close the window.

Note: To restore the default user color bar, select [Default] on the [User Color] window, then push the **ENTER** knob. Secondly, select [Yes] and push the **ENTER** knob.

[Screen Layout] (User1/User2): Select the screen layout for the user mode display.

[Display Mode] (User1/User2): Select the displays to show on the user mode display. According to the setting for [Screen Layout], the setting range changes. For details of the layout for each display, see Appendix 2 "SCREEN LAYOUT".

Note: Some menu options for [Screen Layout] and [Display Mode] are grayed out depending on the side looking setting (see page 1-10).

<input type="checkbox"/>	[LE]* ¹ , [HE]* ¹ , [LT]* ¹ , [HT]* ¹
<input type="checkbox"/> <input type="checkbox"/> <input type="checkbox"/>	[LE+HE]* ^{1, *2} , [LT+HT]* ¹ , [LT+LF]* ¹ , [LT+HF]* ¹ , [HT+LF]* ¹ , [HT+HF]* ¹
<input type="checkbox"/> <input type="checkbox"/> <input type="checkbox"/> <input type="checkbox"/>	[LF+HZm+HF], [LZm+LF+HF], [LF+HF+MIX], [HE+LF+HF]* ^{1, *2} , [LE+LF+HF]* ^{1, *2} , [HT+LF+HF]* ¹ , [LT+LF+HF]* ¹

 [LZm+LF+HZm+HF], [LF+HF1+HF2+MIX], [HF+LF1+LF2+MIX],
 [LE+HE+LF+HF]^{*1, *2}, [LT+HT+LF+HF]^{*1}, [LT+LF+HF1+HF2]^{*1},
 [HT+LF+HF1+HF2]^{*1}, [LT+HF+LF1+LF2]^{*1}, [HT+HF+LF1+LF2]^{*1},
 [LT+LF+HF+MIX]^{*1}, [HT+LF+HF+MIX]^{*1}

*1: Requires external fish finder or telesounder.

*2: In side looking mode, the order of the abbreviation may change according to the direction of the transducer.

The meaning for each abbreviation is shown below.

LF:	Low frequency	LE:	Low frequency of external fish finder
HF:	High frequency	HE:	High frequency of external fish finder
LZm:	Low frequency zoom	LT:	Low frequency of telesounder
HZm:	High frequency zoom	HT:	High frequency of telesounder
MIX:	Mix display		

HF1 (LF1) and HF2 (LF2) show the same display. Gain can be adjusted independently for each display. HF1 (LF1) and HF2 (LF2) are unavailable depending on the side looking setting (see page 1-10).

About the mix display:

The mix display compares echo intensity between low and high frequencies, and displays echoes from tiny fish in discriminative colors. This is done by utilizing the fact that tiny fish return a stronger echo against a high frequency rather than a low frequency. It works as follows.

- If a high frequency echo is stronger than the corresponding echo on the low frequency, the high frequency echo is displayed.
- If the low frequency echo is stronger than or equal to the high frequency echo, it is less likely to be a tiny fish and therefore is displayed in blue.
- If the echoes on both frequencies have the intensity corresponding to reddish-brown or red, they are displayed in reddish brown or red. This is necessary to display the zero line and bottom in reddish-brown or red.
- In other words, the echoes displayed in orange to light-blue are considered to be tiny fish such as whitebait.
- The [Color Erase] function is inoperative when the mix display is active.
- To use the mix display, both transducers for HF and LF should face the bottom.

2. SYSTEM MENU

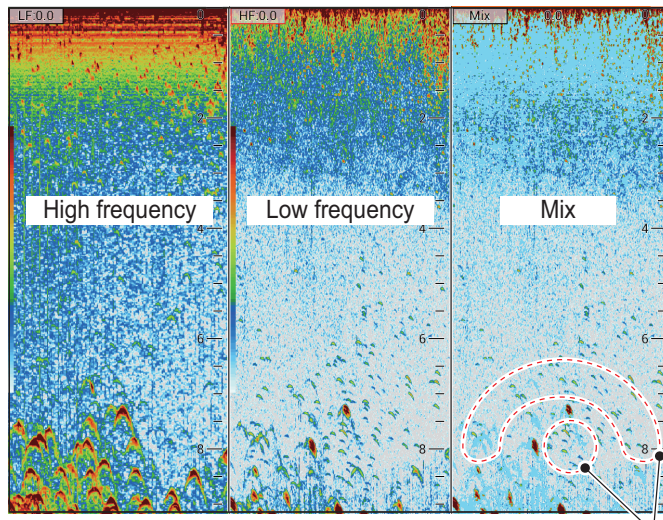

These echoes are likely to be small fish.

2.3 [Range] Menu

The [Range] menu includes the items relevant to the range setting.

Note: When the depth unit is changed all range settings are restored to default. Therefore, it is a good idea to change the depth unit first and then change ranges.

Range1	30ft
Range2	60ft
Range3	120ft
Range4	250ft
Range5	500ft
Range6	1000ft
Range7	1600ft
Range8	3000ft
Zoom Range*	6ft
B/L Range*	16ft
Discrim Zoom*	1/2
Split Range	Off

*: Not available depending on the side looking setting (see page 1-10).

[Range1] - [Range8]: Set the range of each of the eight ranges.

[Zoom Range]: Set the range to zoom in the bottom zoom and marker zoom modes.

[B/L Range]: Set display range for bottom lock and bottom discrimination displays.

[Discrim Zoom]: Select the type for the bottom discrimination display.

- [1/2]: Shows the single picture on the right half of the screen and the bottom discrimination display on the left half of the screen. The bottom discrimination display shows the bottom as a straight line, which is useful for determining bottom hardness.
- [1/3]: This display is similar to the bottom discrimination 1/2 display except the bottom discriminator display occupies the bottom one-third of the left half of the screen.

[Split Range]: Split range enables/disables independent adjustment of range in the dual frequency display. Turn on for independent adjustment. Effective in dual frequency mode only.

2.4 [Auto] Menu

You can activate the auto range or auto shift mode from the [Auto] menu.

Note 1: The [Auto] menu is inoperative when the bottom discrimination display is active.

Note 2: When the side looking mode is active, the auto range and auto shift mode are deactivated.

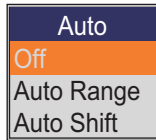

- [Off]: Deactivates the auto range or auto shift mode.
- [Auto Range]: Activates the auto range mode. When the auto range mode is active, the range is automatically changed to keep the bottom echo on the specified area. The **RANGE** and **SHIFT** keys are inoperative and split range mode is deactivated in this mode. Also, "RANGE AUTO" appears at the upper right on the screen.
- [Auto Shift]: Activates the auto shift mode. When the auto shift mode is active, the range shift is automatically adjusted to keep the bottom echo on the specified area. The **SHIFT** key is inoperative and split range mode is deactivated in this mode. Also, "SHIFT AUTO" appears at the upper right on the screen.

2.5 [TX/RX] Menu

The [TX/RX] menu includes the items relevant to the TX and RX settings.

For [Setting] tab

TX Power	
TX Rate	20
Time Lag Tx	Off
Freq. Presets	Freq Control 1
Freq Control 1	▶
200.0kHz/50.0kHz	
Freq Control 2	▶
185.0kHz/50.0kHz	
Freq Control 3	▶
215.0kHz/50.0kHz	
[HF]	
TX Pulse Edge	On
TX Pulse	Std
Pulse Length	1.00msec
RX Band	Std
RX Band Width	0.2kHz
[LF]	
TX Pulse Edge	On
TX Pulse	Std
Pulse Length	0.05msec
RX Band	Std
RX Band Width	0.2kHz

For [External fish finder] tab

TX Power	
TX Rate	20
Freq Control	▶
[HF]	
TX Pulse	Std
Pulse Length	1.00msec
RX Band	Std
RX Band Width	0.2kHz
[LF]	
TX Pulse	Std
Pulse Length	0.05msec
RX Band	Std
RX Band Width	0.2kHz

*: Shown for DFF3.

Note: The [TX/RX] menu for the [External fish finder] tab is inoperative when the ACCU-FISH™ is activated.

[TX Power]: Interference may appear on the screen when an echo sounder having the same frequency as your own is being operated in the vicinity of your vessel. In this case, lower your TX power and contact the vessel to request them to reduce their TX power. The higher the numeric the greater the TX power. For the Setting tab, the TX power for high and low frequency can be set individually. The [Auto] setting automatically adjusts TX power and gain to display the bottom echo optimally. The [Auto] setting is not shown for the [External fish finder] tab and when the transmission mode is [Std] mode. Also, the [Auto] setting is unavailable depending on the side looking setting (see page 1-10).

TX Power	
HF TX Power	9
LF TX Power	10

For [Setting] tab

Note: Use the [Auto] setting with caution, as it also adjusts the gain, which can result in incorrect detection of echoes.

[TX Rate]: Change pulse repetition rate. Normally, the highest rate (20) is used. When in shallow waters second reflection echoes may appear between the surface and actual bottom echo. In this case, lower the TX rate level. A high rate for fast speed; a slow rate for slow speed.

Note: The TX rate may not change when [Pic. Sync] in the [Data Output Setting] menu is set to [On]. This is because of the communications speed limitation between this unit and Shimano's receiver.

[Time Lag]: This equipment can transmit HF and LF signal simultaneously or with time lag. When simultaneous transmission is used, interference may occur depending on the combination of frequencies. If interference occurs, select [HF] or [LF] to transmit HF and LF signals with time lag.

- [Off]: Transmit HF and LF signal simultaneously.
- [HF]: Transmit LF signal after transmitting HF signal.
- [LF]: Transmit HF signal after transmitting LF signal.

Note: When [Echo Setting] is set to [Output] on the [Telesounder] tab, [Time Lag] is inoperative. The [Time Lag] setting is fixed to [Off].

[Freq Control]: Switch the TX mode, and adjust the transducer frequency and sweep width. When change the setting, keep in mind these considerations.

- Set frequency which is suitable for detecting targeted fish.
- Shift frequency so as to reduce interference.
- Lower frequency to increase detection range.
- Raise frequency to improve resolution.

Note: [Freq Control] is operative when the ACCU-FISH™ is deactivated.

1. Open the [System] menu, the select [TX/RX]. The choices [Freq Control 1], [Freq Control 2] and [Freq Control 3] appear in the menu. The currently selected frequency preset appears to the right of [Freq. Presets].

2. SYSTEM MENU

- In the figure below, the high frequency is 200.0kHz, and the low frequency is 50.0kHz.

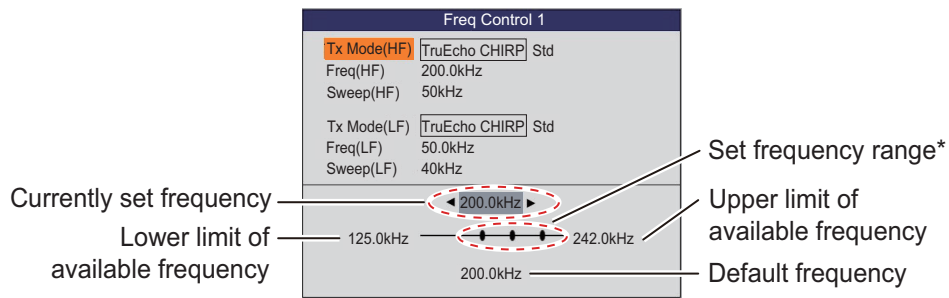

*: Calculated from frequency and sweep.

- Select [Tx Mode(HF)] or [Tx Mode(LF)], then push the **ENTER** knob.
- Select [TruEcho CHIRP] or [Std], then push the **ENTER** knob.
- Select [Freq(HF)] or [Freq(LF)], then push the **ENTER** knob.
- Adjust the frequency at the lower part of the [Freq. Control] window, then push the **ENTER** knob.
- Select [Sweep(HF)] or [Sweep(LF)], then push the **ENTER** knob.
- Adjust the sweep width, then push the **ENTER** knob.
- Press the **MENU/ESC** key to close the [Freq. Control] window.

[TX Pulse Edge] (HF/LF): Turn on to suppress interference to other acoustic equipment (fish finders, scanning sonars, etc.), your own and others.

Note: [TX Pulse Edge] is operative when the ACCU-FISH™ is deactivated or the transmission mode is [Std] mode.

[TX Pulse] (HF/LF): Pulse width changes according to range and shift values. When long range detection is your objective select a long pulse length. For better resolution, select a shorter pulse. [Narrow] raises the detection resolution, however detection range is shorter. [Std] is the standard pulse length, and is suitable for general use. [Wide] increases the detection range but lowers the resolution. [Manual] enables manual setting of pulse length, at [Pulse Length].

Note: [TX Pulse] is operative when the ACCU-FISH™ is deactivated or the transmission mode is [Std] mode.

[Pulse Length] (HF/LF): Operative when [Manual] is selected at [TX Pulse]. A small value gives better detection resolution, however detection range is shorter. On the other hand, a large value gives better detection range but resolution is lower.

[RX Band] (HF/LF): Rx bandwidth is automatically set according to [TX Pulse Length]. Normally the [Std] position provides good performance. If noise is a problem switch to [Narrow]. For better resolution, select [Wide]. [Manual] enables manual setting of Rx band width, at [RX Band Width].

Note: [RX Band] is operative when the ACCU-FISH™ is deactivated or the transmission mode is [Std] mode.

[RX Band Width] (HF/LF): Operative when [Manual] is selected at [RX Band]. A small value decreases the noise. On the other hand, a large value gives better resolution.

2.6 [Key] Menu

The [Key] menu provides operations related to keys.

[Key Beep]: Turns on/off the beep which sounds when a key is operated.

[+/- key]: Adjusts range, shift. Available with FCV-1900/FCV-1900B only.

2.7 [Language] Menu

The [Language] menu selects the language to use. The FCV-1900 series supports the languages shown in the figure below.

English
Français
Español
Dansk
Norsk
中文
日本語
한국어
Русский язык

2.8 [Units] Menu

The [Units] menu lets you select the units of measurement.

Depth	m
Speed	kn
Temp	°F
Fish Size*	inch

*: Not available depending on the side looking setting (see page 1-10).

[Depth]: Select unit of depth measurement.

[Speed]: Select unit of speed measurement. Requires speed sensor.

[Temp]: Select unit of water temperature measurement. Requires water temperature sensor.

[Fish Size]: Select unit of fish size measurement.

2.9 [NMEA Port Set&Monitor] Menu

The [NMEA Port Set&Monitor] menu sets up the NMEA ports and provides information for the input/output data sentences of the NMEA ports.

To set up the NMEA port, select the port that you want to set up and open the [Setting] window.

Port selection

NMEA1	Set up the CN-10 (NMEA1) port.
NMEA2	Set up the CN-11 (NMEA2) port.
SC	Set up the CN-12 (NMEA3) port.
CIF	Set up the CN-6 (SONDE/TRIG) port.



[Setting] window

Communication port monitor display (see chapter 3.)

[MENU/ESC] : Setting
Select Exit menu to exit

[NMEA0183]: Select NMEA0183 version of navigation equipment connected to the NMEA port. This menu item is not available for [SC] and [CIF]. Setting range: [Ver1.5], [Ver2.0], [Ver3.0], [Special]. [Special] is for use with a navigation equipment whose baud rate is 600 bps.

[Output Data]: Select the data to output from the NMEA port to navigation equipment. This menu item is not available for [SC] and [CIF].

- [Depth]: Output the depth data.
- [Water Temp]*: Output the water temperature data. Requires the water temperature sensor.
- [Bottom Discrim]*: Output the bottom discrimination data. Requires BBDS1.
- [Fish Size]*: Output the fish size data. Available with FCV-1900G.

*: Not available when [NMEA0183] is set to [Special].

[TLL Output]: Select the TLL data type to output from the NMEA port to a chart plotter. This menu item is not available for [SC] and [CIF].

- [Off]: Not output TLL data.
- [TLL]: Output latitude/longitude*¹ data only.

- [FURUNO-TLL]: Output latitude/longitude*¹, water temperature*¹, bottom discrimination*², depth, and fish size data*³. This requires FURUNO-TLL enabled device.

*¹: Requires appropriate sensor.

*²: Requires BBDS1.

*³: Available with FCV-1900G.

[Baud Rate]: Set the baud rate of the transmission signal. The setting range is changed according to the port. This menu item is not available for [SC] (setting value is fixed to "38400 bps").

- For [NMEA1] and [NMEA2]: 600, 4800 and 38400 bps
- For [CIF]: 600, 1200, 2400 and 4800 bps

[Start Bit]: Show the character size of the TX data.

[Data Length]: Show the bit length of the TX data.

[Stop Bit]: Show the stop bit size of the TX data.

[Parity]: Show the parity of the TX data.

[Clear Window]: Refresh the information on the communication port monitor display.

[Exit]: Close the [NMEA Port Set&Monitor] menu to return the normal menu.

2.10 [Calib] Menu

The [Calib] menu mainly lets you apply offsets to speed, water temperature, and bottom level.

For [Setting] tab

Sound Speed	1500.0 m/s
Temp	0.0°F
Bottom Level*	▶
Bottom Detect Mode	Level
Color Level Threshold	50
Zero Line Rejection	On
Zero Line Area	4.5ft
Zero Line Fill	On
Draft	▶
Gain ADJ	▶
Fish Size*	0
Time Offset	0:00

For [External fish finder] tab

Bottom Level*	▶
Zero Line Rejection	On
Zero Line Area	4.5ft
Draft	▶
Gain ADJ	▶
Fish Size*	0

*: Not available depending on the side looking setting (see page 1-10).

[Sound Speed]: Adjust the sound velocity of the TX/RX signal if the depth indication is incorrect, because of water temperature or salinity density.

[Temp]: If the water temperature indication is wrong, you can correct it here. For example, if the water temperature indication is 2 °F higher than actual water temperature, enter -2.0 °F.

2. SYSTEM MENU

[Bottom Level]: In the default bottom level setting (+0), the equipment judges consecutive strong echoes to be bottom echoes. If, in that setting, the depth indication is unstable, adjust the bottom level. If vertical lines extend upward from the bottom echo in the bottom lock display, lower the bottom level to erase the vertical lines. If the level is too low, however, it may be difficult to distinguish bottom fish from the bottom echo.

[Bottom Detect Mode]: Select whether the bottom lock display detects the bottom based on the signal level or echo color.

- [Level]: The bottom lock display detects the bottom based on the signal level.
- [Color]: The bottom lock display detects the bottom based on the echo color. When [Color] is selected, adjust [Color Level Threshold].

[Color Level Threshold]: This menu item is available when [Bottom Detect Mode] is set to [Color]. The higher the setting, the strong color echo (reddish brown, red) is recognized as the bottom.

[Zero Line Rejection]: Turn the zero line (transmission line) on or off. When turned on, the transmission line disappears, which allows you to see fish echoes near the surface clearly. The length of the transmission line changes with transducer used and installation characteristics. If the width of the transmission line is 0.4 m (default value) or more, set the transmission line width with [Zero Line Area], as below.

[Zero Line Area]: This feature adjusts the transmission line so that the transmission line disappears when the menu item [Zero Line Rejection] is turned on. For a long tail, increase the value. If the transmission line does not disappear, lower the TX power.

[Zero Line Fill]: Turn off to see fish echoes within 1 m from the surface.

[Draft]: The default depth display shows the distance from the transducer. If you would rather show the distance from the sea surface, set your ship's draft. The draft line for HF and LF can be set respectively.

[Gain ADJ]: If the gain is too high or too low, or the gain for the low and high frequencies appears unbalanced, you can compensate it here.

[Fish Size]: Compensate for wrongful indication of fish size.

Bottom lock display

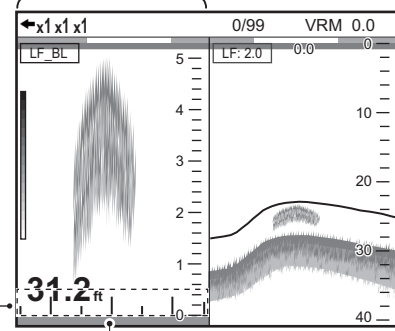

Set the bottom level so that these vertical lines just disappear.

Setting value	Compensation size
+500%	Sextuple
+400%	Quintuple
+300%	Quadruple
+200%	Triple
+100%	Double
+50%	1.5
-50%	1/2
-65%	1/3
-75%	1/4
-80%	1/5

[Time Offset]: Enter the time difference between UTC and local time to display the local date and time. This setting is available when [Date Time] is set to [Local] on the [Data] menu.

2.11 [Stabilization] Menu

The [Stabilization] menu compensates for the effects of heaving, and requires a Satellite Compass™. It is inoperative when there is no data from the Satellite Compass™.

Note: The [Stabilization] menu is unavailable depending on the side looking setting (see page 1-10).

For [Setting] tab		For [External fish finder] tab	
Stabilization	On	Stabilization Sensor	SC-30
Stabilization Sensor	SC-50	Stabilization Area	20m
Stabilization Area	20m	[HF]	
[HF]		TD fore-aft	0.0m
TD fore-aft	0.0m	TD port-stbd	0.0m
TD port-stbd	0.0m	ANT TD height	0.0m
ANT TD height	0.0m	[LF]	
[LF]		TD fore-aft	0.0m
TD fore-aft	0.0m	TD port-stbd	0.0m
TD port-stbd	0.0m	ANT TD height	0.0m
ANT TD height	0.0m		

[Stabilization]: Turn heaving compensation on or off. Turn it on when seas are rough, to get stable echoes, regardless of sea conditions. When turned on, the stabilization icon () shown on the right appears at the upper left of the screen. If the antenna position of the Satellite Compass™ is not set when installing, the message shown to the right appears. Contact your dealer to set the antenna position of the Satellite Compass™.

Antenna to Transducer distances (bow-stern, port-starboard, height) are not set. Have a FURUNO technician adjust your settings.

Yes

[Stabilization Area]: When heaving exceeds the value set here, stabilization is stopped and the stabilization icon at the top of the screen disappears. However, [Stabilization] is kept [On]. When heaving is once again less than the value set here, stabilization is restarted and the stabilization icon reappears.

2.12 [Data Output Setting] Menu (For Japan)

The Tankenmaru system outputs the video signal of FCV-1900/B/G from the main display unit to sub display units on your vessel, via a radio transmitter.

Note 1: The Tankenmaru system is sold only in Japan (as of May 2015).

Note 2: The Tankenmaru system cannot output video from an external fish finder.

Note 3: The [Data Output Setting] menu is unavailable depending on the side looking setting (see page 1-10).

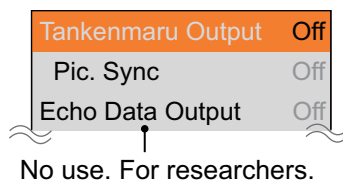

[Tankenmaru Output]: Select [HF] or [LF] to output this unit's video signal to sub display units in the Tankenmaru system.

[Pic. Sync]: Select whether or not to synchronize the picture between the main display and sub displays. The changes made to the main display picture (Picture Advance Speed) are not reflected on the sub displays.

- [On]: Display the same video as the main display for the frequency selected at [Tankenmaru Output]. Note that the TX interval is longer when compared to the [Off] setting.
- [Off]: The display units are independent of one another.

2.13 [Save Setting] Menu

The [Save Setting] menu saves and loads the setting data.

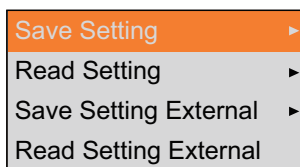

[Save Setting]: Save the current setting data to the internal memory. Six setting data can be saved as [User1] to [User6].

Note: When the setting data for [User1 (or 2, 3, 4, 5, 6)] exists in the internal memory, the confirmation message shown right appears. Select [Yes] to overwrite the setting data.

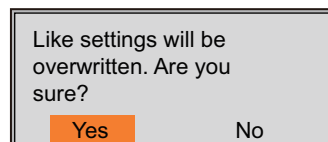

[Read Setting]: Load the setting data from the internal memory.

- [General]: Load the setting data appropriate to the purse seine fishery.
- [Surface]: Load the setting data appropriate to the whitebait fishing.

- [User1] to [User6]: Load the setting data for [User1 (or 2, 3, 4, 5, 6)].

After selecting setting data to load, the confirmation message shown right appears. Select [Yes] to load the setting data.

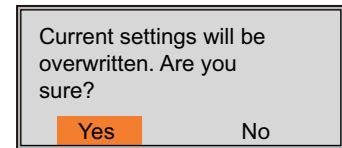

[Save Setting External]: Copy the current setting data saved in the internal memory to a USB flash memory. If a USB flash memory is not connected, the error message shown right appears.

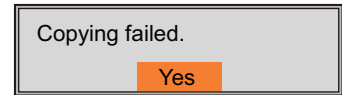

About the USB flash memory:

- Use a USB flash memory formatted to FAT32 whose storage capacity is 32 GB or less.
- Do not use a password-protected USB flash memory.
- Turn off the power to disconnect or connect a USB flash memory. The processor unit may not re-detected a USB flash memory.
- When there is no space in a USB flash memory to save the setting data or screenshots, the message shown right appears.

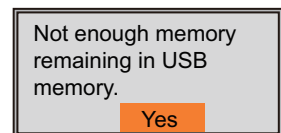

[Read Setting External]: Load the setting data saved in the USB flash memory. After selecting the data file, the confirmation message shown right appears. Select [Yes] to load the setting data.

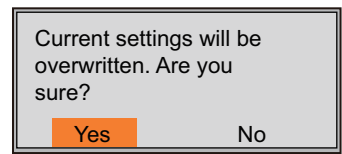

Note: The setting data in the internal memory is overwritten with new setting data. The overwritten data can not be decompressed.

2.14 [Replay Image] Menu

The [Replay Image] menu processes the screenshots saved to the processor unit and USB flash memory.

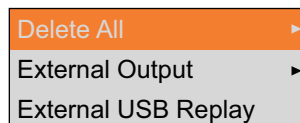

[Delete All]: Delete all screenshots in the internal memory. The confirmation message shown right appears. Select [Yes] to delete all screenshots.

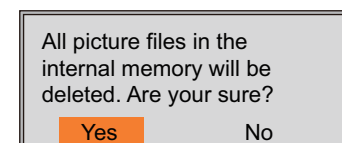

[External Output]: Extract all screenshots in the internal memory to a USB flash memory. After extracting the screenshots, all screenshots in the internal memory are deleted and the indication for the screenshot count at top of the display changes to "0/99". If a USB flash memory is not connected or there are no screenshots in the internal memory, the error message shown below appears.

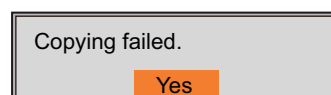

No connection

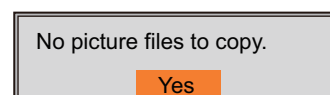

No screenshot data

2. SYSTEM MENU

[External USB Replay]: Replay the screenshot saved to a USB flash memory. The replay window appears after selecting the folder where screenshots are saved.

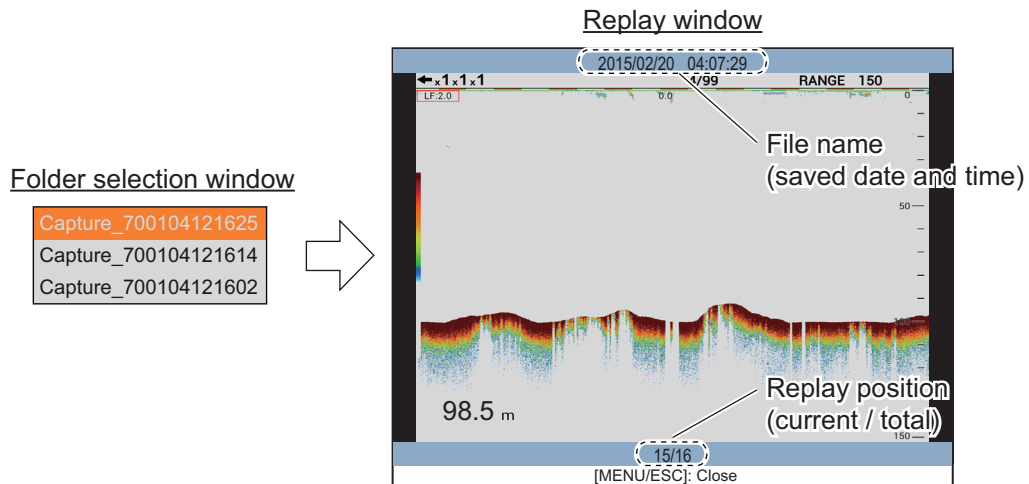

Operation in the replay window

- Rotate the **ENTER** knob to select the replay file.
- Push the **MENU/ESC** key to close the replay window.

If a USB flash memory is not connected or there are no screenshots in the USB flash memory, the error message shown right appears.

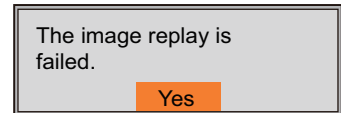

2.15 [Record Video Data] Menu

The [Record Video Data] menu records the video data and saves it to a USB flash memory.

Note 1: A USB flash memory is required for video data recording.

Note 2: The video data may be corrupted when the power supply is interrupted while recording the data.

Note 3: The [Record Video Data] menu is unavailable while replaying video data.

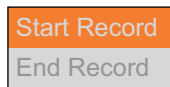

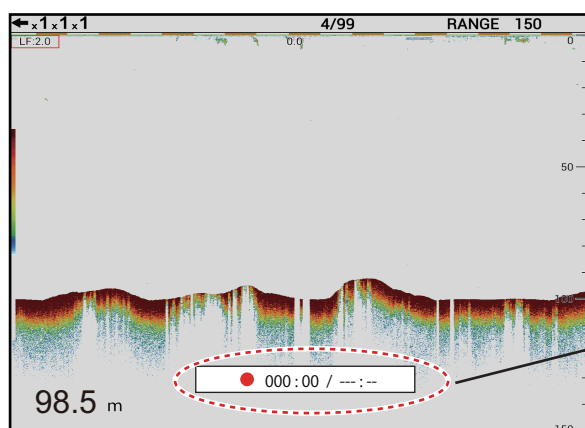

[Start Record]: Start recording video data. A window appears on the bottom of the screen while recording the data and counts the recording time.

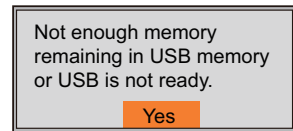

This window indicates that the fish finder is recording data and it shows the recording time.

Note 1: If a USB flash memory is not connected or there is not enough capacity on the USB flash memory, the error message shown to the right appears.



Note 2: When the disk capacity falls below 25 MB while recording the video data, the icon () flashes on the display and recording is automatically stopped.

Note 3: When **MODE** key is pressed while recording, the message shown to the right appears. Select [Yes] to stop recording and switch the display mode.

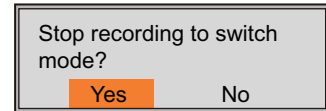

[End Record]: Stop recording video data. This menu item is operative after starting the record. The message shown to the right appears after selecting [End Record]. Select [Yes] to stop recording.

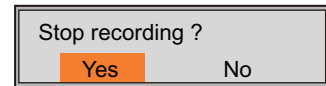

2.16 [Replay Video Data] Menu

The [Replay Video Data] menu processes the video data saved on the USB flash memory.

Note: The [Replay Video Data] menu is unavailable while recording the video data.

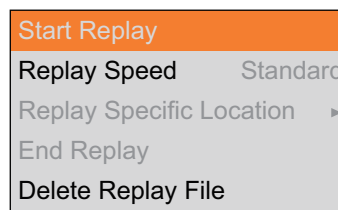

[Start Replay]: Start replaying video data saved on the USB flash memory. The replay starts after selecting the file to replay.

File selection window

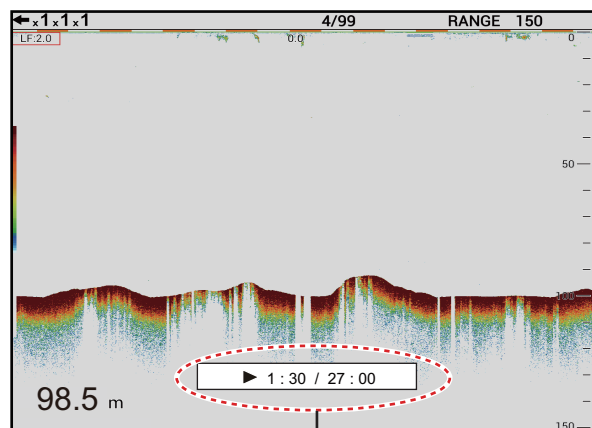
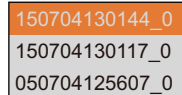

This window appears while replaying video and shows the current and total times.

- ▶ : [Replay Speed] is set to [Standard].
- ▶▶ : [Replay Speed] is set to [Fast].

[Replay Speed]: Select the replay speed ([Standard] or [Fast]).

2. SYSTEM MENU

[Replay Specific Location]: Select the replay location. Rotate the **ENTER** knob to select the replay location, then press the knob. This menu item is operative while replaying the video.

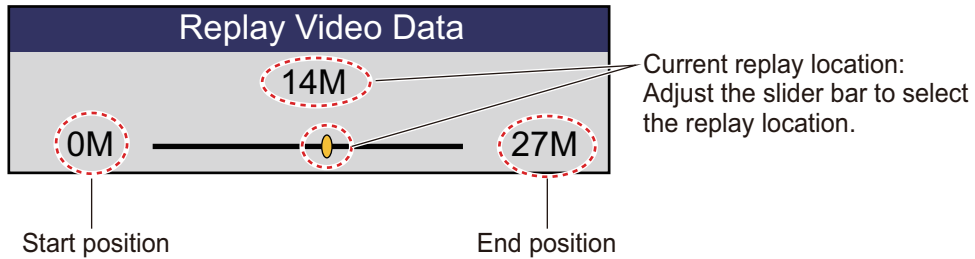

[End Replay]: Stop replaying video data. The message shown to the right appears after selecting [End Replay]. Select [Yes] to stop replaying. This menu item is operative while replaying the video.



[Delete Replay File]: Delete the video data saved on the USB flash memory. Select the file to delete from the file selection window. When you want to delete all video data, select [Delete All]. The message shown below appears after selecting the file, select [Yes] to delete the file(s). This menu item is unavailable while replaying the video.



Delete a file

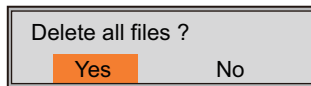

Delete all files

3. MAINTENANCE & TROUBLE-SHOOTING

This chapter provides maintenance and troubleshooting procedures for the operator.

WARNING

ELECTRICAL SHOCK HAZARD
Do not open the equipment.

This equipment uses high voltage that can cause electrical shock. Only qualified persons can work inside the equipment.

NOTICE

Do not apply paint, anti-corrosive sealant or contact spray to plastic parts or equipment coating.

Those items contain products that can damage plastic parts and equipment coating.

3.1 Maintenance

Regular maintenance is essential for good performance. Check the points shown in the table below.

Check Point	Action	Remedy, remarks
Cable	Check that all cabling is firmly connected and is not damaged.	<ul style="list-style-type: none"> • Connect the cable if it has loosened. • Replace damaged cables.
Connectors on units	Check for tight connection.	<ul style="list-style-type: none"> • Reconnect as necessary.
Ground on units	Check for tight connection and rust.	<ul style="list-style-type: none"> • Fasten if loosened. • Remove rust if present.
Dust	Remove the dust or dirt from the units with a soft, dry cloth.	<ul style="list-style-type: none"> • Do not use chemical cleaners to clean the equipment because they can remove paint and markings.
Transducer	Marine life on the transducer face will result in a gradual decrease in sensitivity. Check the transducer face for cleanliness each time the boat is dry-docked.	<ul style="list-style-type: none"> • Carefully remove any marine life to prevent the damage to the transducer. • Do not paint the transducer. • Do not use chemical cleaners to clean the transducer.

3.2 Fuse Replacement

The fuse (Type: FGB01 250V 20A, Code No.: 000-155-775-10) at the rear of the processor unit protects the processor unit from overvoltage and internal fault. If a fuse blows find the cause before replacing it. If it blows again after replacement, contact your dealer for advice.

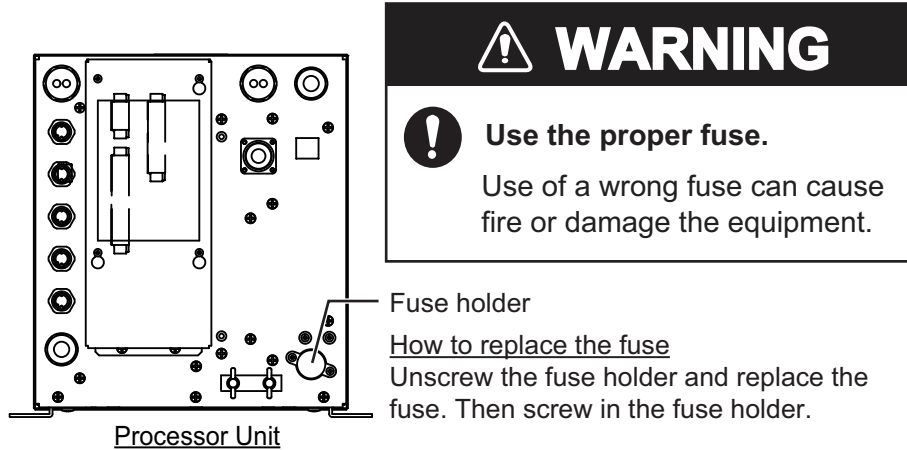

3.3 Troubleshooting









The table below provides basic troubleshooting procedures which the user may follow to restore normal operation. If you can not restore normal operation, do not check inside the unit. Contact your dealer to check the equipment.

Problem	Reason, remedy
Cannot turn on power.	<ul style="list-style-type: none"> The power cable is disconnected or damaged. Check the power cable. If damaged, replace it. The cable connected to the control unit is disconnected or damaged. Check the cable, and reconnect or replace it as necessary. Check ship's mains. Check the fuse on the processor unit. If the fuse has blown, find the cause then replace it.
There is no response when a key is pressed.	<ul style="list-style-type: none"> The cable connected to the control unit is disconnected or damaged. Check the cable, and reconnect or replace it as necessary. Reboot the system. If you do not get a response, the key may be damaged. Contact your dealer for instructions.
No echo appears but fixed range scale appears.	<ul style="list-style-type: none"> Picture advance is stopped. Set [Pic. Advance] on the [Sounder] menu to other than [Stop]. Transducer cable is disconnected or damaged. Check the cable, and reconnect or replace it as necessary.
Echo appears but no zero line.	<ul style="list-style-type: none"> The range shift is set to "0". Set scale to show zero line. The zero line rejection is turned on. Turn it off on the [Calib] menu. The setting of the draft line is improper. Check the setting for [Draft] on the [Calib] menu.

Problem	Reason, remedy
Sensitivity is low.	<ul style="list-style-type: none"> • Gain setting is too low. Raise the gain. • Marine life is adhering to transducer face. Clean the transducer face. • Vessel is in heavily sedimented water. • Bottom is too soft to return an echo.
Extreme interference or noise.	<ul style="list-style-type: none"> • Transducer is located too close to the engine. Relocate the transducer. • Ground wire has loosened or damaged. Check the wire, and reconnect or replace it as necessary. • Same-frequency echo sounder is operating nearby.
No depth indication.	<ul style="list-style-type: none"> • Bottom is off the screen. Change the range setting.
Speed and/or water temperature readout is unrealistic or not shown.	<ul style="list-style-type: none"> • The sensor cable is disconnected or damaged. Check the cable, and reconnect or replace it as necessary. • The sensor is malfunctioning. Check the sensor.
Position readout is unrealistic or not shown.	<ul style="list-style-type: none"> • The cable connected to the navigation equipment is disconnected or damaged. Check the cable, and reconnect or replace it as necessary. • The navigation equipment is malfunctioning. Check the navigation equipment.
The message "License confirmation failed. The equipment will start up with the standard version." appears after turning the turning the FCV-1900/B/G on.	If the FCV-1900B and FCV-1900G fails the license confirmation, this message appears. In this case, select [Yes] to start up with the FCV-1900 and ask your dealer for advise.
The message "The connection is timed out" appears after turning the turning the FCV-1900/B/G on.	Communication error between the MAIN board and CTRL board in the processor unit. Turn the power off, then contact your dealer to check the connection between the MAIN board and CTRL board in the processor unit or the connection between the processor unit and Ethernet HUB (HUB-101).

3.4 Error Icon

The table below shows the error icons which may appear at the top of the display. All error icons are accompanied with an audio alert. To silence the audio alert, press any key. The error icon is displayed until the cause of the error is rectified.

Icon	Reason	Remedy
	Communication error between the control unit and processor unit.	Check the connection between the control unit and processor unit. If this error occurs repeatedly, contact your dealer.
	Communication error between the MAIN board and CTRL board in the processor unit.	Contact your dealer to check the connection between the MAIN board and CTRL board in the processor unit or the connection between the processor unit and Ethernet HUB (HUB-101).
	Overcurrent in the processor unit is detected.	Check the connection between the processor unit and transducer. If the error is not rectified, the internal wiring of the processor unit may be incorrect or the transducer may be malfunctioning. Contact your dealer to check the equipment.
	Overvoltage in the processor unit is detected.	Check the connection between the processor unit and transducer. If the error is not rectified, the internal wiring of the processor unit may be incorrect or the transducer may be malfunctioning. Contact your dealer to check the equipment.
	Abnormal rotation speed of the fan on the MAIN board is detected.	Contact your dealer to check the fan.
	Abnormal rotation speed of the fan on the CTRL board is detected.	Contact your dealer to check the fan.
	The temperature of the CPU on the MAIN board is too high.	Check that the ambient temperature around the processor unit is within -15°C to +55°C. If this error occurs repeatedly, contact your dealer.
	Communication error between the transducer and processor unit.	Check the connection between the transducer and processor unit. If this error occurs repeatedly, contact your dealer.
	Communication error between the external fish finder and processor unit.	Check the connection between the external fish finder and processor unit or the connection between the Ethernet HUB (HUB-101) and external fish finder. If this error occurs repeatedly, contact your dealer.

3.5 Communication Port Monitor

The communication port monitor provides information for the input/output data sentences of the NMEA ports.

1. Press the **MENU/ESC** key, then open the [Setting] tab.
2. Select [System], then push the **ENTER** knob.
3. Select [NMEA Port Set&Monitor], then push the **ENTER** knob.

NMEA1	Shows the information of the CN-10 (NMEA1) port.
NMEA2	Shows the information of the CN-11 (NMEA2) port.
SC	Shows the information of the CN-12 (NMEA3) port.
CIF	Shows the information of the CN-6 (SONDE/TRIG) port.

4. Select the port to display the input/output data, then push the **ENTER** knob.
5. Press the **MENU/ESC** key to close the menu window and show the communication port monitor display.

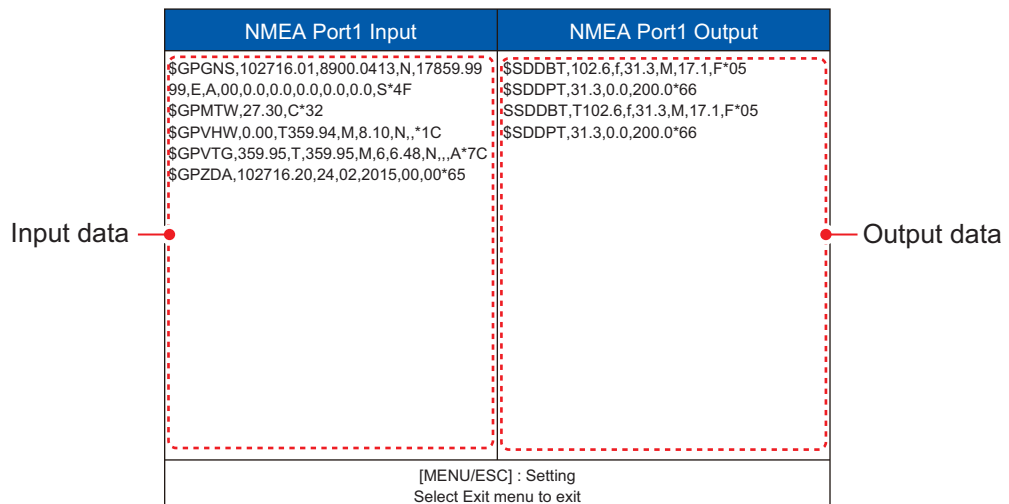

6. Press the **MENU/ESC** and select [Exit], then push the **ENTER** knob.
7. Select [Yes], then push the **ENTER** knob to close the communication port monitor display.
8. Press the **MENU/ESC** key several times to close the menu.

3.6 Diagnostic Test

The diagnostic test checks the equipment for proper operation and displays various information. To perform the diagnostic test, do the following:

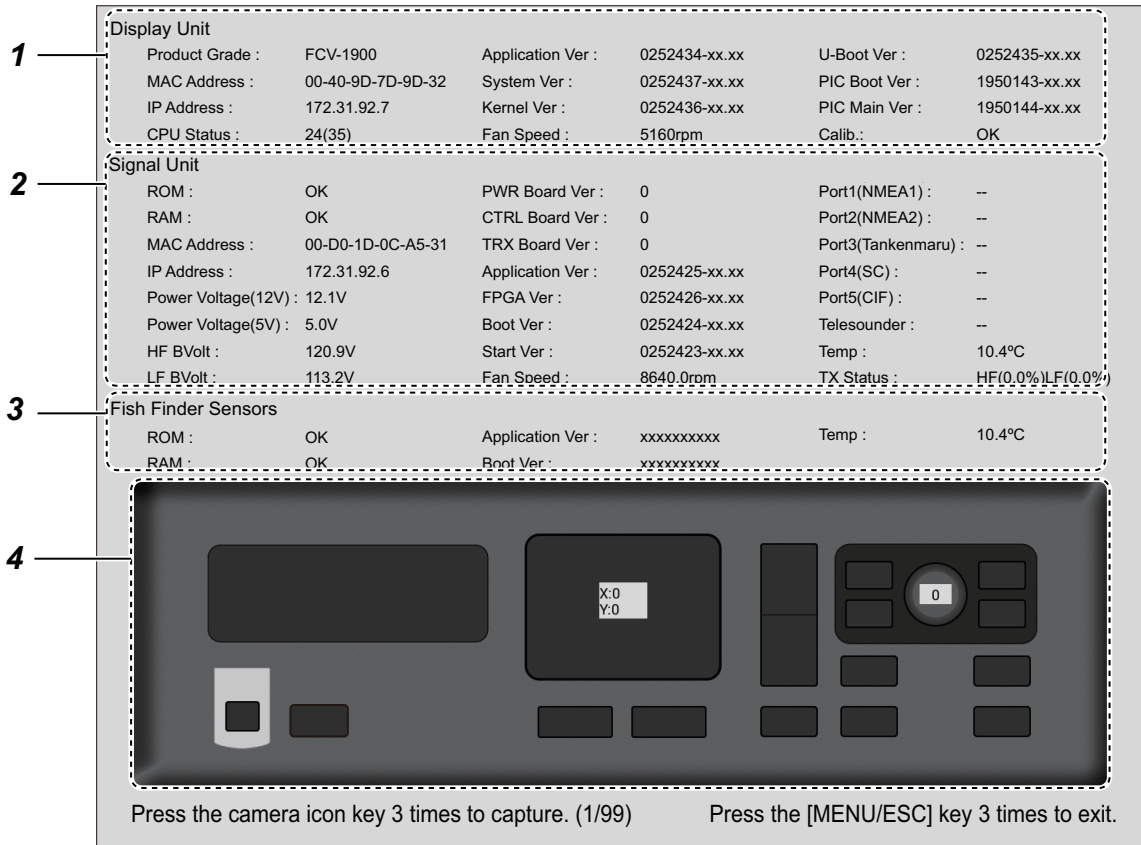

1. Press the **MENU/ESC** key, then open the [Setting] tab.
2. Select [System], then push the **ENTER** knob.
3. Select [Tests], then push the **ENTER** knob.
4. Select [Diagnostic Test], then push the **ENTER** knob.



xx.xx: Program version

No.	Description
1	The check result and information for the MAIN board (19P1084/A). Shows model name, MAC address, IP address, CPU temperature, program no., and fan speed.
2	The check result and information for the CTRL board (02P6392). Shows ROM/RAM check (OK or NG), MAC address, IP address, input voltage, B voltage, connector connection test* ¹ , circuit board version no., program version no., water temperature, fan speed* ² and overcurrent rate. *1: "--" appears normally. This test is used for the check in the factory. *2: When an error occurs, "ERRORx" appears. (x: The number of error)
3	The check result and information for the external fish finder. Shows ROM/RAM check (OK or NG), program no., water temperature.

No.	Description
4	Check controls for proper operation. <ul style="list-style-type: none"> • Keys: Push each key. The key's on-screen location turns gray or light blue alternately and a beep sounds with each push. • ENTER knob: Rotate the knob clockwise or counterclockwise. Clockwise rotation increases the value; counterclockwise rotation decreases it. Next, push the control. Its on-screen location turns black or blue alternately and a beep sounds with each push. • Touchpad: Move your finger across the touchpad. Rightward movement increases the value of [X]; leftward movement decreases the value of [X]; Upward movement decreases the value of [Y]; downward movement increases the value of [Y].

Note: The diagnostic test screen can be captured by pressing the / key three times.

5. Press the **MENU/ESC** key three times to close the self test window.
6. Press the **MENU/ESC** key several times to close the menu.

3.7 LCD Test

The LCD test checks for proper display of all colors. To perform the LCD test, do the following:

1. Press the **MENU/ESC** key, then open the [Setting] tab.
2. Select [System], then push the **ENTER** knob.
3. Select [Tests], then push the **ENTER** knob.
4. Select [LCD Test], then push the **ENTER** knob.
5. Press any key except the **MENU/ESC** key to start the test.
6. Press any key except the **MENU/ESC** key to change the screen, in the sequence shown below.

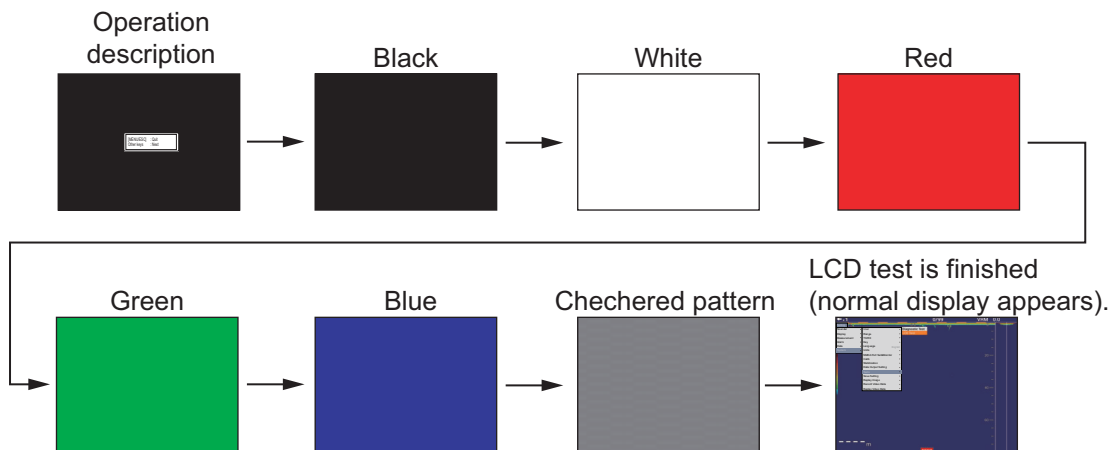

Note: Press the **MENU/ESC** key to quit the test.

7. Press the **MENU/ESC** key several times to close the menu.

3. MAINTENANCE & TROUBLESHOOTING

This page is intentionally left blank.

APPENDIX 1 MENU TREE

[Setting] tab

[Setting]

- Sounder —
 - Interference (Off, Low, **Medium**, High, Auto), F: Yes
 - Color Erase (0 to 50%, **0%**), F: Yes
 - White Edge (**Off**, 1 to 10), F: Yes
 - Clutter, F: Yes
 - HF Clutter (0 to 100%, **40%**)
 - HF Curve (**Std**, Linear)
 - LF Clutter (0 to 100%, **40%**)
 - LF Curve (**Std**, Linear)
 - TVG, F: Yes
 - HF TVG Level (0 to 9, **3**)
 - HF TVG Distance (100 to 3000 ft, **600 ft**)
 - LF TVG Level (0 to 9, **3**)
 - LF TVG Distance (100 to 3000 ft, **600 ft**)
 - STC, F: Yes
 - HF STC (0 to 10, **0**)
 - LF STC (0 to 10, **0**)
 - Pic. Advance (Stop, 1/16, 1/8, 1/4, 1/2, **x1**, x2, x4), F: Yes
 - Smoothing (Off, 1 to 9, **3**), F: Yes
 - Bottom Zone, F: Yes
- Display —
 - A-Scope (**Off**, Normal, Peak), F: Yes
 - Temp Graph (**Off**, Narrow, Normal, Wide), F: Yes
 - Temp Color (**Std**, White, Red, Black, Yellow), F: Yes
 - Display Division (□□, □□), F: Yes
 - Window Size (3:1, 2:1, **1:1**, 1:2, 1:3), F: Yes
 - Zoom Mode (**Bottom Lock**, Bottom Zoom, Marker Zoom, Discrim Zoom), F: Yes
 - Zoom Marker (Off, **On**), F: Yes
 - Colors (8, 16, **64**), F: Yes
 - Hue (**Std**, Hue1 to Hue5, Custom), F: Yes
 - Back Ground (White, Light Blue, Blue, **Dark Blue**, Black), F: Yes
 - Window Color (**Day**, Night), F: Yes
 - Depth Size (Off, **Normal**, Zoom), F: Yes
 - Depth Scale (**Right**, Center, Off), F: Yes
 - Color Bar (Off, **On**), F: Yes
 - Function Display (Off, **Key (F1/F2)**, Key (1/2/3)), F: Yes
 - Mode&Gain Display (Off, **On**), F: Yes
 - Data Position (**Upper Left**, Lower Left, Upper Right, Lower Right), F: Yes
- Measurement —
 - ACCU-FISH (FCV-1900/B: **Off**, Symbol; FCV-1900G: Off, **Graph**, Symbol), F: Yes
 - Measure Area (**Std**, All Area), F: No
 - [Graph Display]
 - Graph Style* (**Horizontal**, Vertical), F: Yes *: Available with FCV-1900G
 - Graph Size* (**Small**, Middle, Large), F: Yes
 - Graph Location* (**Upper Left**, Lower Left, Upper Right, Lower Right), F: Yes
 - Graph Scale End* (16inch, 24inch, 32inch, **39inch**, 47inch, 63inch, 79inch), F: Yes
 - Distributed Scale Start* (0 to 5%, **3%**), F: Yes
 - Distributed Scale End* (10 to 100%, **50%**), F: Yes
 - Number of graph bars* (**Max. 16 bars**, Max. 8 bars, Max. 4 bars), F: Yes
 - Transparency* (**Off**, 1 to 4), F: Yes
 - Updating Cycle* (500 msec, 700 msec, 1 s, 2 s, **3 s**), F: Yes
 - Area Marker (**Std**, All Area) F: Yes
 - [Mark Display]
 - Fish Info (**Fish Size**, Depth), F: Yes
 - Fish Symbols (Off, **Fish Mark**, Point Mark), F: Yes

Bold Italic: Default setting
F: Yes: Items which can be programmed to the **F1** and **F2** key.

①

APPENDIX 1 MENU TREE

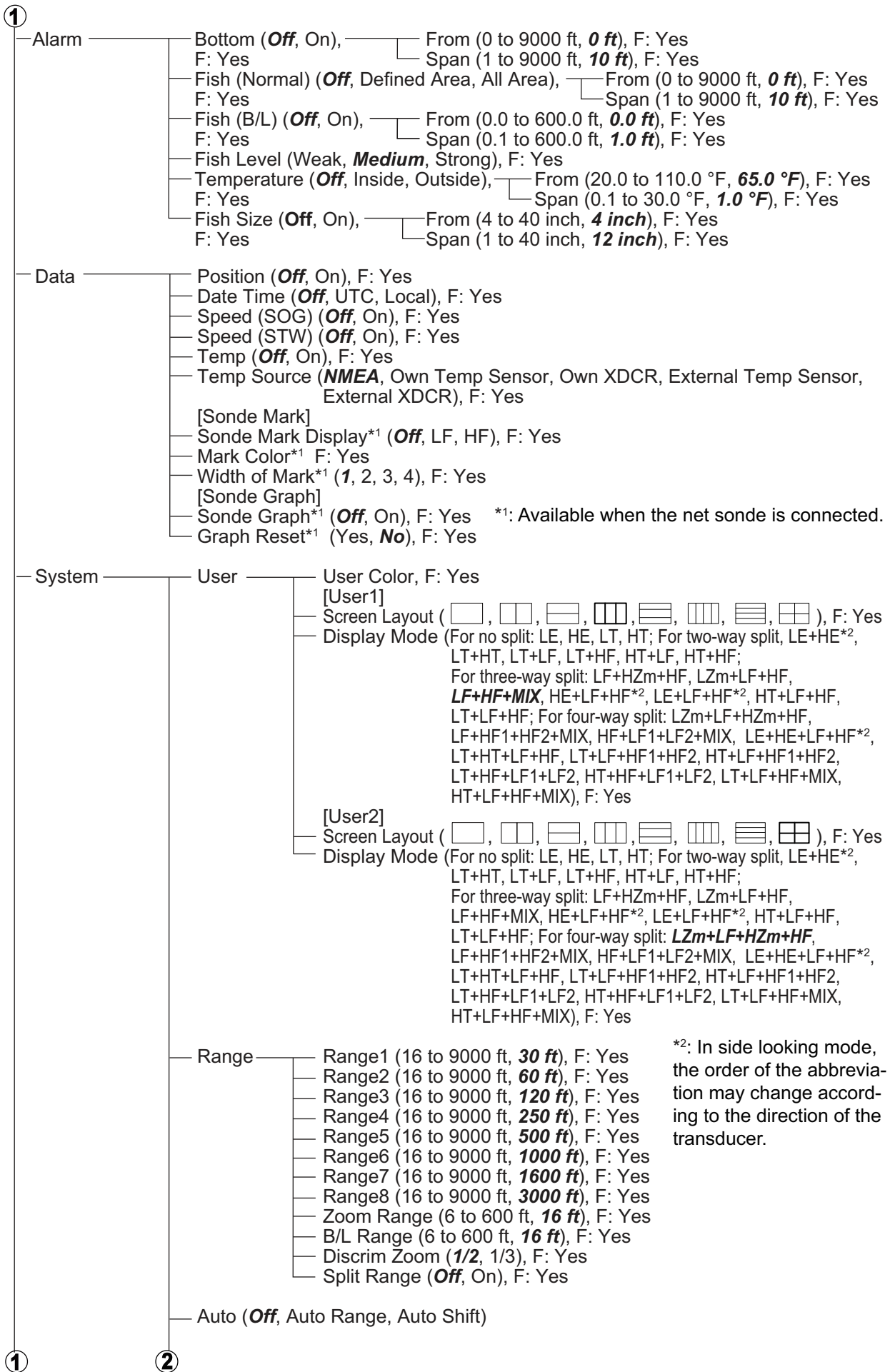

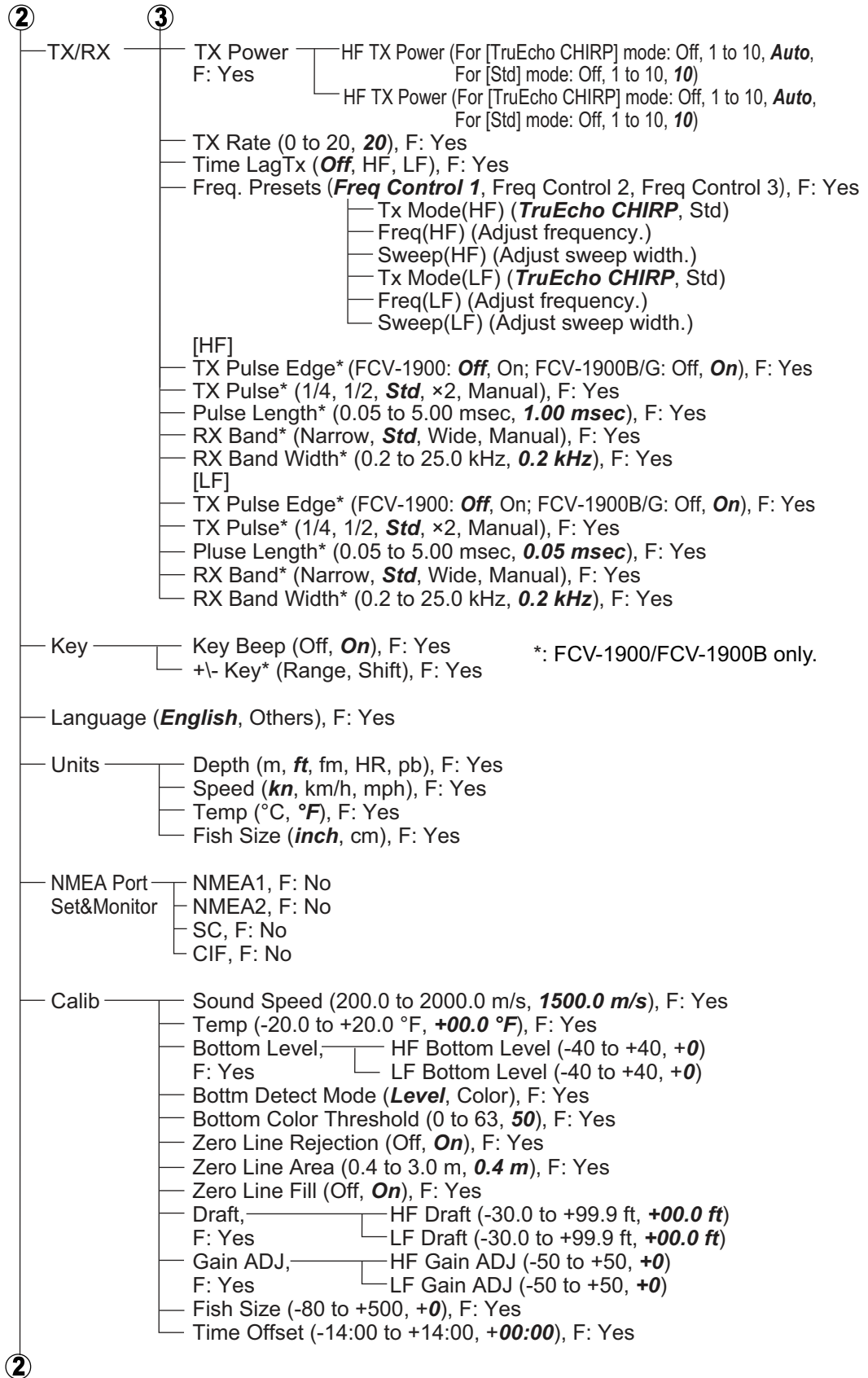

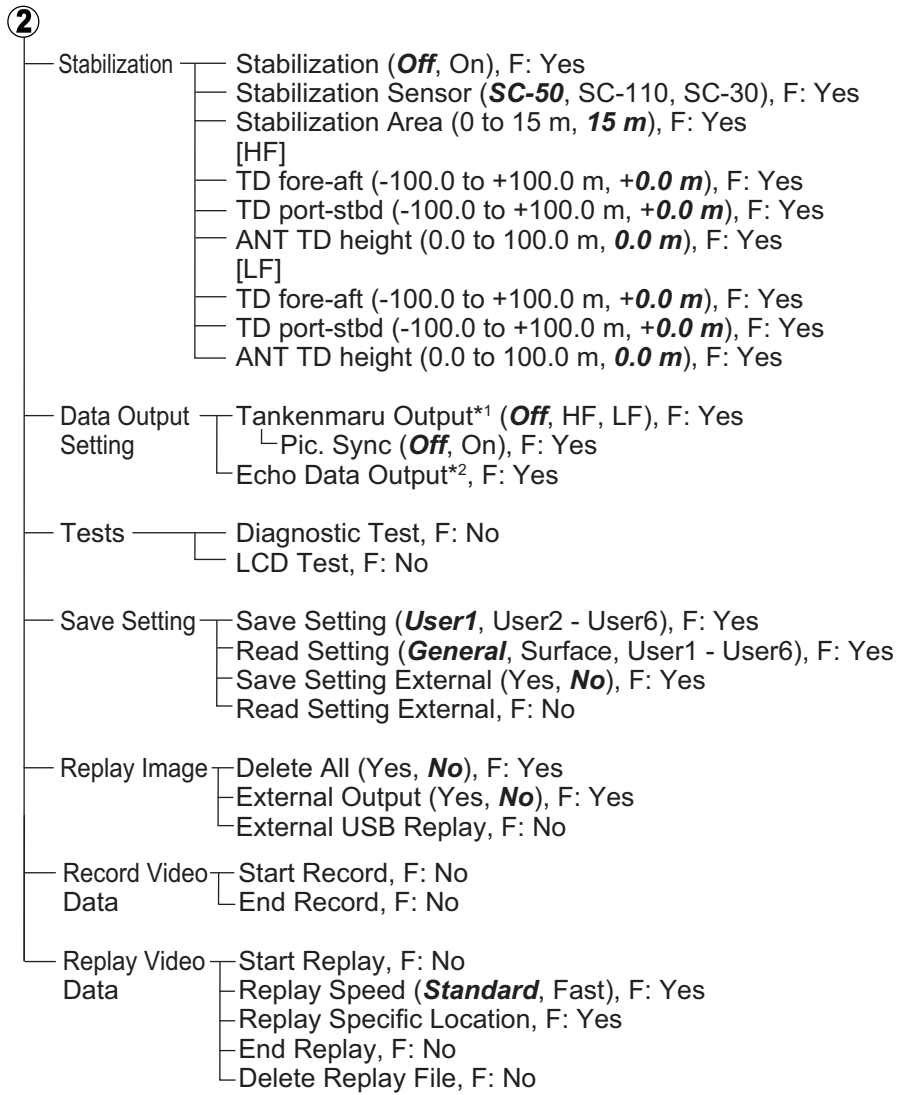

*1: Available when the Tankenmaru system is connected.

*2: No use. For researchers.

[External fish finder] tab

[DFF1], [DFF3] or [BBDS1]

Bold Italic: Default setting

- Sounder
 - Color Erase (0 to 50%, **0%**)
 - Clutter (0 to 100%, For DFF1/BBDS1: **0%**, For DFF3: **40%**)
 - TVG
 - HF TVG Level (0 to 9, For DFF1/BBDS1: **5**, For DFF3: **3**)
 - LF TVG Level (0 to 9, For DFF1/BBDS1: **5**, For DFF3: **3**)
 - STC
 - HF STC (0 to 10, **0**)
 - LF STC (0 to 10, **0**)
 - Pic. Advance (Stop, 1/16, 1/8, 1/4, 1/2, **x1**, x2, x4)
 - Smoothing (Off, 1 to 4, **3**)

- Display*1
 - Bottom Discrim (Off, Graphic, 4 colors, **Probability**)
 - Legend (Off, **On**)

- Measurement — ACCU-FISH (**Off**, On)

*1: Shown for BBDS1.
*2: Shown for DFF3.

- System
 - TX/RX
 - TX Power (Off, 1 to 10, **10**)
 - TX Rate (0 to 20, **20**)
 - [Freq Presets]*1
 - Freq Control 1 (23.0kHz/38.0kHz)
 - Freq Control 2 (23.0kHz/38.0kHz)
 - Freq Control 3 (23.0kHz/38.0kHz)
 - [HF]
 - TX Pulse Edge*3 (FCV-1900: **Off**, On; FCV-1900B/G: Off, **On**), F: Yes
 - TX Pulse*3 (1/4, 1/2, **Std**, x2, Manual), F: Yes
 - Pulse Length*3 (0.01 to 5.00 msec, **1.00 msec**), F: Yes
 - RX Band*3 (Narrow, **Std**, Wide, Manual), F: Yes
 - RX Band Width*3 (0.2 to 25.0 kHz, **0.2 kHz**), F: Yes
 - [LF]
 - TX Pulse Edge*1 (FCV-1900: **Off**, On; FCV-1900B/G: Off, **On**), F: Yes
 - TX Pulse*1 (1/4, 1/2, **Std**, x2, Manual), F: Yes
 - Pulse Length*1 (0.01 to 5.00 msec, **0.05 msec**), F: Yes
 - RX Band*1 (Narrow, **Std**, Wide, Manual), F: Yes
 - RX Band Width*1 (0.2 to 25.0 kHz, **0.2 kHz**), F: Ye

 - Calib
 - Bottom Level
 - HF Bottom Level (-40 to +40, **+0**)
 - LF Bottom Level (-40 to +40, **+0**)
 - Zero Line Rejection (Off, **On**)
 - Zero Line Area (0.4 to 3.0 m, **0.4 m**)
 - Draft
 - HF Draft (-15.0 to +50.0 ft, **+0.0 ft**)
 - LF Draft (-15.0 to +50.0 ft, **+0.0 ft**)
 - Gain ADJ
 - HF Gain ADJ (-50 to +50, **+0**)
 - LF Gain ADJ (-50 to +50, **+0**)
 - Fish Size (-80 to +100, **+0**)

 - Stabilization
 - Stabilization Sensor (SC-50, SC-110, **SC-30**)
 - Stabilization Area (0 to 15 m, **15 m**)
 - [HF]
 - TD fore-aft (-100.0 to +100.0 m, **+0.0 m**)
 - TD port-stbd (-100.0 to +100.0 m, **+0.0 m**)
 - ANT TD height (0.0 to 100.0 m, **0.0 m**)
 - [LF]
 - TD fore-aft (-100.0 to +100.0 m, **+0.0 m**)
 - TD port-stbd (-100.0 to +100.0 m, **+0.0 m**)
 - ANT TD height (0.0 to 100.0 m, **0.0 m**)

[Telesounder] tab

[Telesounder]

Bold Italic: Default setting

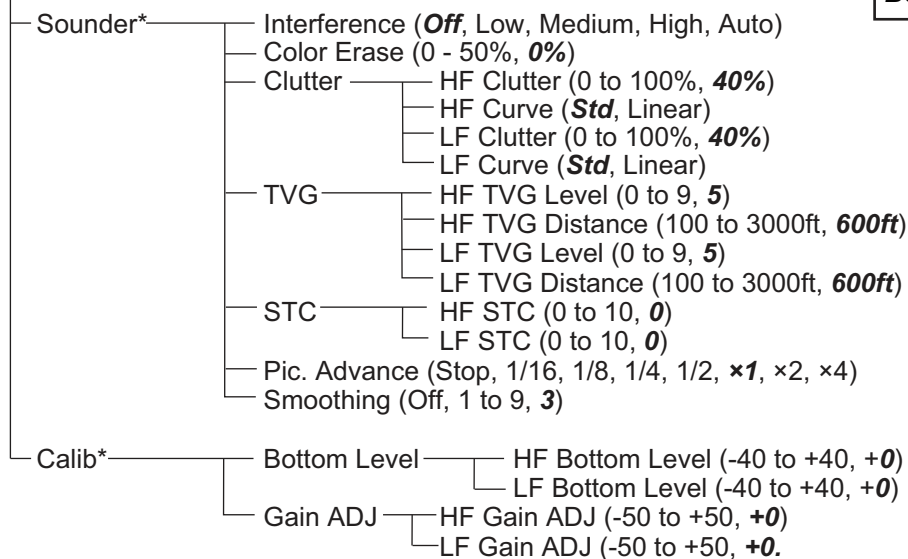

*: Available with the mother ship.

APPENDIX 2 SCREEN LAYOUT

The user display may be divided as desired with [Screen Layout] on the [User] menu.

Note: The screen layouts for normal mode are shown below. In side looking mode, the order of the abbreviation and layout may change according to the direction of the transducer.

No split

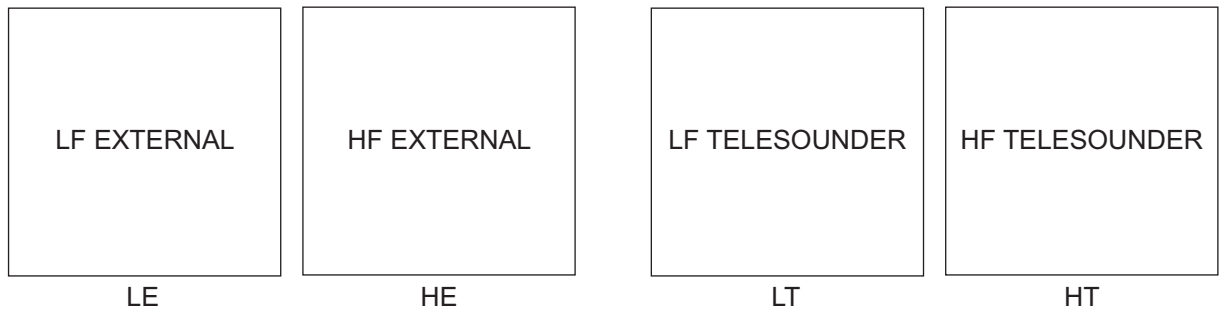

Two-way split

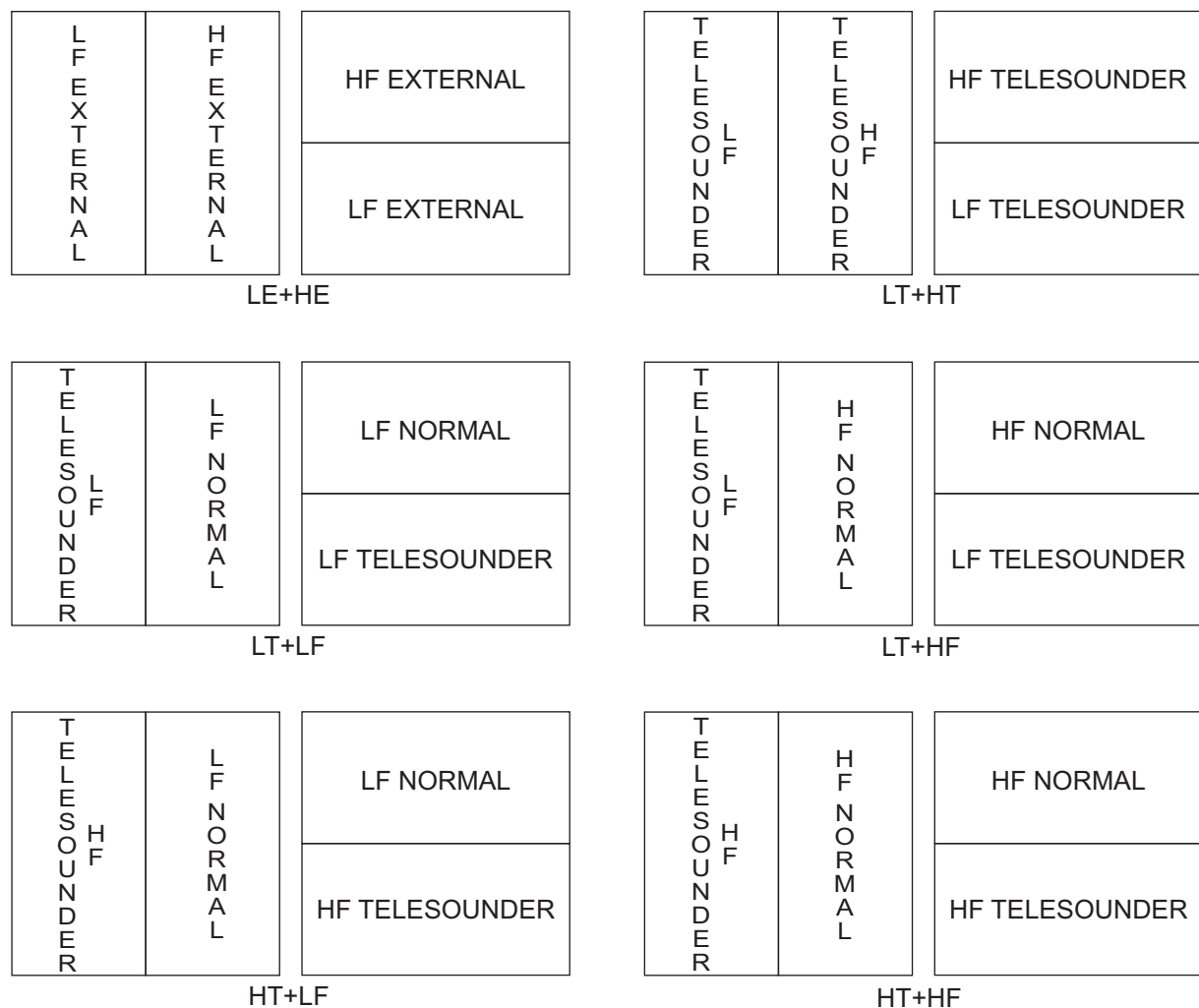

Three-way split

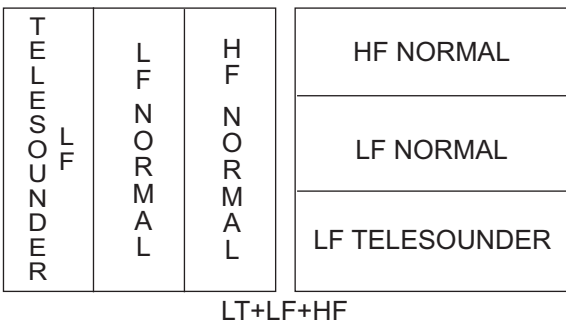
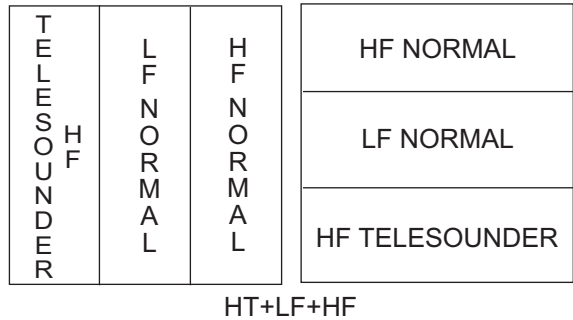
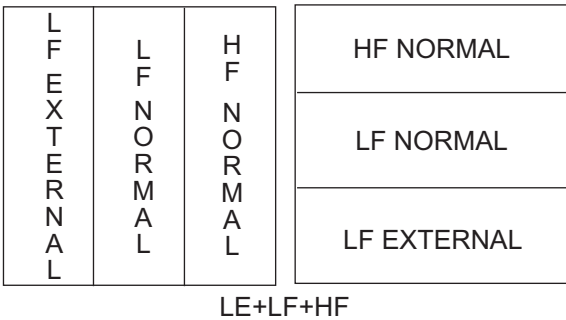
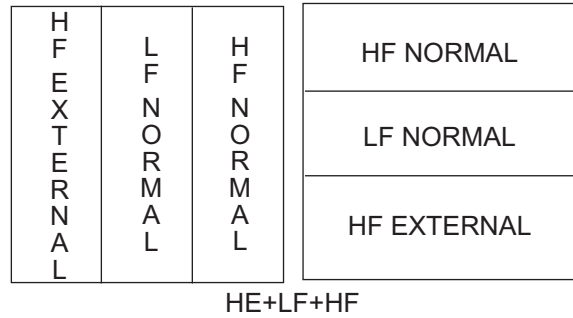
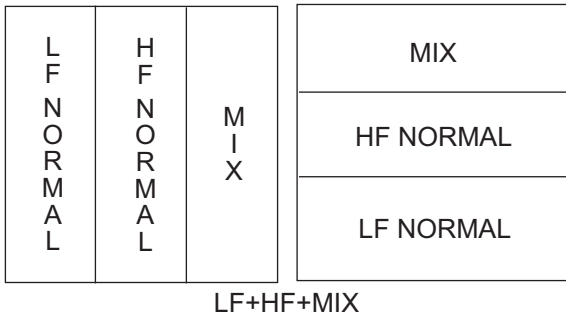
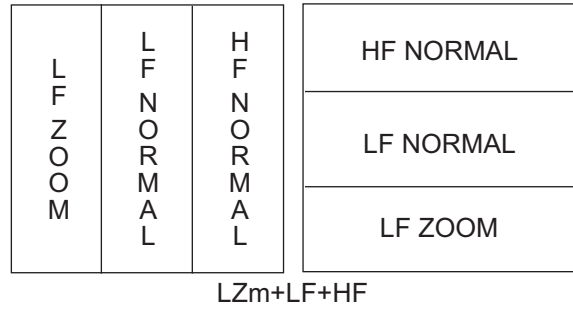
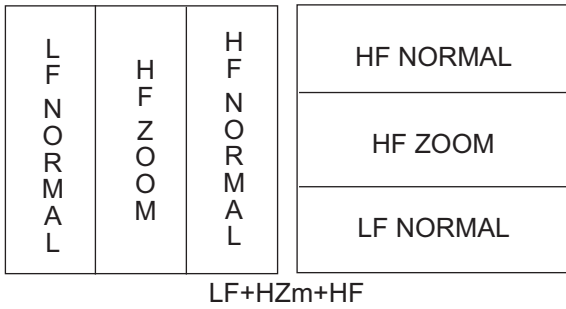

Four-way split

HF1 (LF1) and HF2 (LF2) show the same display. Gain can be adjusted independently for each.

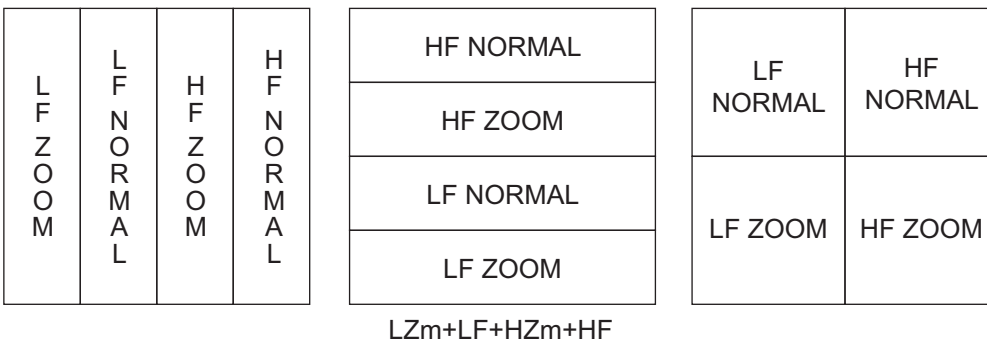

L F N O R M A L
H F N O R M A L 1
H F N O R M A L 2
M I X

MIX
HF NORMAL2
HF NORMAL1
LF NORMAL

HF NORMAL1	MIX
LF NORMAL	HF NORMAL2

LF+HF1+HF2+MIX

H F N O R M A L
L F N O R M A L 1
L F N O R M A L 2
M I X

MIX
LF NORMAL2
LF NORMAL1
HF NORMAL

LF NORMAL1	MIX
HF NORMAL	LF NORMAL2

HF+LF1+LF2+MIX

L F E X T E R N A L
H F E X T E R N A L
L F N O R M A L
H F N O R M A L

HF NORMAL
LF NORMAL
HF EXTERNAL
LF EXTERNAL

HF EXTERNAL	HF NORMAL
LF EXTERNAL	LF NORMAL

LE+HE+LF+HF

T E L E S O U N D E R L F
T E L E S O U N D E R H F
L F N O R M A L
H F N O R M A L

HF NORMAL
LF NORMAL
HF TELESOUNDER
LF TELESOUNDER

HF TELE- SOUNDER	HF NORMAL
LF TELE- SOUNDER	LF NORMAL

LT+HT+LF+HF

T E L E S O U N D E R L F
L F N O R M A L
H F N O R M A L 1
H F N O R M A L 2

HF NORMAL2
HF NORMAL1
LF NORMAL
LF TELESOUNDER

LF NORMAL	HF NORMAL2
LF TELE- SOUNDER	HF NORMAL1

LT+LF+HF1+HF2

APPENDIX 2 SCREEN LAYOUT

TELE SOUNDER	HF	LF NORMAL	HF NORMAL 1	HF NORMAL 2	HF NORMAL2	LF NORMAL	HF NORMAL2
					HF NORMAL1	HF TELE- SOUNDER	HF NORMAL1
					LF NORMAL		
					HF TELESOUNDER		
HT+LF+HF1+HF2							
TELE SOUNDER	LF	HF NORMAL	LF NORMAL 1	LF NORMAL 2	LF NORMAL2	HF NORMAL	LF NORMAL2
					LF NORMAL1	LF TELE- SOUNDER	LF NORMAL1
					HF NORMAL		
					LF TELESOUNDER		
LT+HF+LF1+LF2							
TELE SOUNDER	HF	HF NORMAL	LF NORMAL 1	LF NORMAL 2	LF NORMAL2	HF NORMAL	LF NORMAL2
					LF NORMAL1	HF TELE- SOUNDER	LF NORMAL1
					HF NORMAL		
					HF TELESOUNDER		
HT+HF+LF1+LF2							
TELE SOUNDER	LF	LF NORMAL	HF NORMAL	MIX	MIX	LF NORMAL	MIX
					HF NORMAL	LF TELE- SOUNDER	HF NORMAL
					LF NORMAL		
					LF TELESOUNDER		
LT+LF+HF+MIX							
TELE SOUNDER	HF	LF NORMAL	NOR MAL HF	MIX	MIX	LF NORMAL	MIX
					HF NORMAL	HF TELE- SOUNDER	HF NORMAL
					LF NORMAL		
					HF TELESOUNDER		
HT+LF+HF+MIX							

APPENDIX 3 DISPLAY DIVISION

The dual frequency display may be divided vertically and horizontally with [Display Division] on the [Display] menu.

Note: The screen layouts for normal mode are shown below. In side looking mode, the order of the abbreviation and layout may change according to the direction of the transducer.

Horizontal division

	LF or HF	DUAL	HF-ZOOM/LF-ZOOM										
NORMAL	<div style="border: 1px solid black; padding: 10px; text-align: center;"> LF/HF NORMAL </div>	<div style="border: 1px solid black; padding: 10px;"> <table border="1" style="width: 100%; text-align: center;"> <tr><td>HF NORMAL</td></tr> <tr><td>LF NORMAL</td></tr> </table> </div>	HF NORMAL	LF NORMAL	<div style="border: 1px solid black; padding: 10px;"> <table border="1" style="width: 100%; text-align: center;"> <tr><td>LF/HF NORMAL</td></tr> <tr><td>LF/HF ZOOM</td></tr> </table> </div>	LF/HF NORMAL	LF/HF ZOOM						
HF NORMAL													
LF NORMAL													
LF/HF NORMAL													
LF/HF ZOOM													
A-SCOPE "ON"	<div style="border: 1px solid black; padding: 10px;"> <table border="1" style="width: 100%;"> <tr> <td style="width: 80%; text-align: center;">LF/HF NORMAL</td> <td style="width: 20%; text-align: center;">A I S C O P E</td> </tr> </table> </div>	LF/HF NORMAL	A I S C O P E	<div style="border: 1px solid black; padding: 10px;"> <table border="1" style="width: 100%;"> <tr> <td style="width: 80%; text-align: center;">HF NORMAL</td> <td style="width: 20%; text-align: center;">A I S C P</td> </tr> <tr> <td style="text-align: center;">LF NORMAL</td> <td style="text-align: center;">A I S C P</td> </tr> </table> </div>	HF NORMAL	A I S C P	LF NORMAL	A I S C P	<div style="border: 1px solid black; padding: 10px;"> <table border="1" style="width: 100%;"> <tr> <td style="width: 80%; text-align: center;">LF/HF NORMAL</td> <td style="width: 20%; text-align: center;">A I S C P</td> </tr> <tr> <td style="text-align: center;">LF/HF ZOOM</td> <td style="text-align: center;">A I S C P</td> </tr> </table> </div>	LF/HF NORMAL	A I S C P	LF/HF ZOOM	A I S C P
LF/HF NORMAL	A I S C O P E												
HF NORMAL	A I S C P												
LF NORMAL	A I S C P												
LF/HF NORMAL	A I S C P												
LF/HF ZOOM	A I S C P												

Vertical division

	LF or HF	DUAL	HF-ZOOM/LF-ZOOM								
NORMAL	<div style="border: 1px solid black; padding: 10px; text-align: center;"> LF/HF NORMAL </div>	<div style="border: 1px solid black; padding: 10px;"> <table border="1" style="width: 100%; text-align: center;"> <tr> <td style="width: 50%;">L F N O R M A L</td> <td style="width: 50%;">H F N O R M A L</td> </tr> </table> </div>	L F N O R M A L	H F N O R M A L	<div style="border: 1px solid black; padding: 10px;"> <table border="1" style="width: 100%; text-align: center;"> <tr> <td style="width: 50%;">L F / H F Z O O M</td> <td style="width: 50%;">N O R M A L / H F</td> </tr> </table> </div>	L F / H F Z O O M	N O R M A L / H F				
L F N O R M A L	H F N O R M A L										
L F / H F Z O O M	N O R M A L / H F										
A-SCOPE "ON"	<div style="border: 1px solid black; padding: 10px;"> <table border="1" style="width: 100%;"> <tr> <td style="width: 80%; text-align: center;">LF/HF NORMAL</td> <td style="width: 20%; text-align: center;">A I S C O P E</td> </tr> </table> </div>	LF/HF NORMAL	A I S C O P E	<div style="border: 1px solid black; padding: 10px;"> <table border="1" style="width: 100%;"> <tr> <td style="width: 33%; text-align: center;">L F N O R M A L</td> <td style="width: 33%; text-align: center;">H F N O R M A L</td> <td style="width: 33%; text-align: center;">A I S C O P E</td> </tr> </table> </div>	L F N O R M A L	H F N O R M A L	A I S C O P E	<div style="border: 1px solid black; padding: 10px;"> <table border="1" style="width: 100%;"> <tr> <td style="width: 33%; text-align: center;">L F / H F Z O O M</td> <td style="width: 33%; text-align: center;">N O R M A L / H F</td> <td style="width: 33%; text-align: center;">A I S C O P E</td> </tr> </table> </div>	L F / H F Z O O M	N O R M A L / H F	A I S C O P E
LF/HF NORMAL	A I S C O P E										
L F N O R M A L	H F N O R M A L	A I S C O P E									
L F / H F Z O O M	N O R M A L / H F	A I S C O P E									

**SPECIFICATIONS OF FISH FINDER
FCV-1900/1900B/1900G**

1 GENERAL

- 1.1 Transmitting frequency 15 kHz to 200 kHz, Free-synthesize
- 1.2 Output power 1, 2 or 3 kWrms
- 1.3 Transmitting rate 10 to 2700 pulse/min (5 to 3000 m range, normal mode)
- 1.4 Transmitting mode
 - FCV-1900 Standard mode only
 - FCV-1900B/1900G TruEcho CHIRP™ or standard mode selected either
- 1.5 Pulselength
 - Standard mode 0.05 to 5 ms
 - TruEcho CHIRP™ mode 0.05/0.06 ms
- 1.6 External monitor (required specifications)
 - Display resolution XGA (1024x768), SXGA (1280x1024), SXGA (1024x1280), FHD (1920x1080)
 - Interface HDMI type-D or DVI-D
(Vertical synchronous frequency for XGA: 70 Hz)

2 PROCESSOR UNIT

- 2.1 Color indication
 - Echo color 8, 16 or 64 colors according to echo intensity
 - Back color Select from 5 colors
- 2.2 Hue 7 steps (standard, Hue 1 to 5, customized)
- 2.3 Echo display mode Single mode (high/low frequency), Dual-frequency, Zoom, User 1/2
User 1/2 available to use mixture, multi-gain, telesounder and external sounder display
- 2.4 Zoom display Bottom-lock expansion, Bottom zoom, Marker zoom, Discrimination zoom
- 2.5 Depth range 5 to 3000 m
- 2.6 Range shift 2000 m max.
- 2.7 Expansion range 2 to 200 m
- 2.8 Fish size histogram (FCV-1900G only) 2 m depth or more, specified transducer required
- 2.9 Bottom discrimination Range: 5 to 100 m, Speed: 10 kn or less, BBDS1 required
- 2.10 ACCU-FISH™ 2 m depth or more, specified transducer required
- 2.11 Display advanced speed 6 steps (Lines/TX: Freeze, 1/16, 1/8, 1/4, 1/2, 1/1, 2/1, 4/1)
- 2.12 Data recording (videos and screenshots) Echo display and measured data can be recorded internal memories
- 2.13 Language Chinese, Danish, English, French, Japanese, Korean, Russian, Spanish, Norwegian

3 INTERFACE

3.1	Number of port	
	NMEA	3 ports, NMEA V1.5/2.0/3.0
	LAN	1 port, Ethernet 100Base-TX (HUB required)
	CIF	1 port
	Net sonde	1 port (sonde marker/ sonde KP)
	Video signal	1 port, HDMI type-D
	External KP	1 port
	Temperature sensor	1 port
	Echo data	1 port, for telesounder* connection (optional Interface unit required)
	USB	1 port, USB2.0 (specified monitor brilliance control available)

*: sold in Japan only.

3.2 Data sentences

Input	GGA, GLL, GNS, MTW, VHW, VTG, ZDA
Output	DBS, DBT, DPT, MTW, TLL

3.3 Output proprietary sentences

PFEC	SDbcd, SDflg, SDmrk, pidat
------	----------------------------

4 POWER SUPPLY

4.1	Processor unit	12-24 VDC: 8.3-3.9 A
4.2	Rectifier (option)	
	RU-1746B-2	100/110/115/220/230 VAC, 1 phase, 50/60 Hz
4.3	AC/DC power supply unit (option)	
	PR-240	100-115/200-230 VAC, 1 phase, 50/60 Hz
	PR-241	100-230 VAC, 1 phase, 50-60 Hz

5 ENVIRONMENTAL CONDITIONS

5.1	Ambient temperature	-15°C to +55°C
5.2	Relative humidity	95% or less at +40°C
5.3	Degree of protection	IP22
5.4	Vibration	IEC 60945 Ed.4

6 UNIT COLOR

6.1	Processor/ Control unit	N2.5
-----	-------------------------	------

INDEX

A

ACCU-FISH	1-32
activating/deactivating	1-33
fish info.....	1-34
fish symbols	1-33
Alarm	
activating	1-35
bottom alarm	1-34
bottom lock fish alarm	1-34
fish size alarm	1-34
normal fish alarm.....	1-34
water temperature alarm	1-34
A-scope display.....	1-31
Auto menu.....	2-6
Auto range mode	2-6
Auto shift mode	2-6

B

Background color	1-43
Bottom discrimination display	1-7
4 colors display	1-40
activating	1-41
graphic display	1-40
probability display.....	1-41
Bottom display area	1-42
Bottom lock display	1-5
Bottom zoom display.....	1-6
Brilliance	1-3

C

Calib menu	2-11
Clutter	1-29
Color bar	1-44
Color erase	1-28
Color quantity	1-43

D

Data menu	1-45
Data Output Setting menu	2-14
Depth indication size	1-43
Depth measurement	1-14
Diagnostic test	3-6
Display division	1-43
Display menu	1-43
Display mode	1-3
Distributed scale end	1-45
Distributed scale start	1-45
Dual frequency display.....	1-5

E

Error icon	3-4
External fish finder tab	1-17

F

Fish size histogram	1-18
Frequency control	2-7

Function display	1-44
Function keys	1-25
Fuse replacement	3-2

G

Gain	
adjustment.....	1-14
Graph scale end.....	1-45
Graph size.....	1-44

I

Interference rejector	1-28
-----------------------------	------

K

Key menu	2-9
----------------	-----

L

Language menu	2-9
LCD test	3-7

M

Maintenance	3-1
Measurement menu	1-44
Measuring mode	
bottom trace mode	1-20, 1-22
entire area mode	1-20, 1-21
specific area mode	1-20, 1-22
specific range mode	1-20, 1-21
Menu tree	AP-1
Mix display	2-3

N

NMEA Port Set&Monitor menu	2-10
----------------------------------	------

P

Past echo	1-15
Picture advance speed	1-27
Power on/off	1-2

R

Range menu	2-5
Range selection	1-12
Range shifting	1-13

S

Screenshot	
delete	1-24, 2-15
extract	2-15
replay	1-24, 2-16
save.....	1-23
Scroll back mode.....	1-15
Setting tab	1-16
Smoothing	1-42
Sonde mark.....	1-37
Sounder menu	1-42
Stabilization menu.....	2-13
STC	1-42
System configuration.....	x
System menu	2-1

T	
Telesounder tab	1-17
Time offset	2-13
Transmission mode	
Std mode	vi
TruEcho CHIRP mode	vi
Transparency	1-45
Troubleshooting	3-2
TVG	1-30
TX/RX menu	2-6
U	
Unit menu	2-9
Updating cycle	1-45
User 1 and 2 displays	
description	1-8
User menu	2-1
V	
Video	
deleting replay file(s)	2-18
replay speed	2-17
selecting replay location	2-18
start recording	2-16
start replaying	2-17
stop recording	2-17
stop replaying	2-18
VRM	1-14
V-temperature graph	1-39
W	
Water temperature graph color	1-43
White Edge	1-42
Window color	1-43
Z	
Zoom marker	1-43
Zoom mode	1-43

EC Declaration of Conformity



We **FURUNO ELECTRIC CO., LTD.**

(Manufacturer)

9-52 Ashihara-Cho, Nishinomiya City, 662-8580, Hyogo, Japan

(Address)

declare under our sole responsibility that the product

FISH FINDER FCV-1900, FCV-1900B and FCV-1900G

(Model name, type number)

to which this declaration relates is in conformity with the following standard(s) or other normative document(s)

IEC 60945 Ed.4.0: 2002 incl. Corr. 1: 2008
IEC 60945 Ed.3.0: 1996, clauses 10.2 and 10.3

(title and/or number and date of issue of the standard(s) or other normative document(s))

For assessment, see

- Test Report FLI 12-14-125, FLI 12-14-126, FLI 12-14-132 and FLI 12-14-133, February 25, 2015 prepared by Furuno Labotech International Co., Ltd.

This declaration is issued according to the Directive 2014/30/EU of the European Parliament and of the Council of 26 February 2014 on the harmonisation of the laws of the Member States relating to electromagnetic compatibility.

On behalf of Furuno Electric Co., Ltd.

Nishinomiya City, Japan
April 20, 2016

(Place and date of issue)

Yoshitaka Shogaki
Department General Manager
Quality Assurance Department

(name and signature or equivalent marking of authorized person)