

FURUNO

NAVnet
3D

MULTI FUNCTION DISPLAY

Model **MFD8/MFD12**



Model MFD12

MFD8, MFD12 OPERATOR'S MANUAL

FURUNO ELECTRIC CO., LTD.

ECF

(Elemental Chlorine Free)

The paper used in this manual is elemental chlorine free.

FURUNO ELECTRIC CO., LTD.

9-52 Ashihara-cho,
Nishinomiya, 662-8580, JAPAN

FURUNO Authorized Distributor/Dealer

All rights reserved. Printed in Japan

FIRST EDITION : APR. 2008
J : DEC. 12, 2017



00016780218

Pub. No. OME-44440-J

(YOSH) MFD8/MFD12

 **FURUNO ELECTRIC CO., LTD.**

www.furuno.com

IMPORTANT NOTICES

General

- This manual has been authored with simplified grammar, to meet the needs of international users.
- The operator of this equipment must read and follow the descriptions in this manual. Wrong operation or maintenance can cancel the warranty or cause injury.
- Do not copy any part of this manual without written permission from FURUNO.
- If this manual is lost or worn, contact your dealer about replacement.
- The contents of this manual and equipment specifications can change without notice.
- The example screens (or illustrations) shown in this manual can be different from the screens you see on your display. The screens you see depend on your system configuration and equipment settings.
- Save this manual for future reference.
- Any modification of the equipment (including software) by persons not authorized by FURUNO will cancel the warranty.
- The following concern acts as our importer in Europe, as defined in DECISION No 768/2008/EC.
 - Name: FURUNO EUROPE B.V.
 - Address: Ridderhaven 19B, 2984 BT Ridderkerk, The Netherlands
- All brand and product names are trademarks, registered trademarks or service marks of their respective holders.
- SD, SDHC Logos are trademarks of SD-3C, LLC.
- RotoKey is a registered trademark or trademark of FURUNO Electric Co., Ltd.

How to discard this product

Discard this product according to local regulations for the disposal of industrial waste. For disposal in the USA, see the homepage of the Electronics Industries Alliance (<http://www.eiae.org/>) for the correct method of disposal.

How to discard a used battery

Some FURUNO products have a battery(ies). To see if your product has a battery, see the chapter on Maintenance. Follow the instructions below if a battery is used. Tape the + and - terminals of battery before disposal to prevent fire, heat generation caused by short circuit.

In the European Union

The crossed-out trash can symbol indicates that all types of batteries must not be discarded in standard trash, or at a trash site. Take the used batteries to a battery collection site according to your national legislation and the Batteries Directive 2006/66/EU.

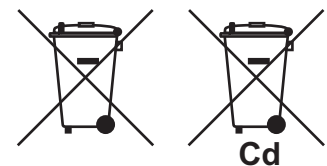

In the USA

The Mobius loop symbol (three chasing arrows) indicates that Ni-Cd and lead-acid rechargeable batteries must be recycled. Take the used batteries to a battery collection site according to local laws.

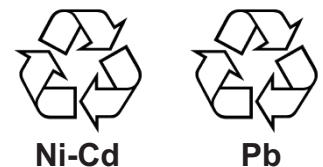



In the other countries

There are no international standards for the battery recycle symbol. The number of symbols can increase when the other countries make their own recycle symbols in the future.



SAFETY INSTRUCTIONS

Read these safety instructions before you operate the equipment.

 WARNING	Indicates a condition that can cause death or serious injury if not avoided.
 CAUTION	Indicates a condition that can cause minor or moderate injury if not avoided.

 Warning, Caution	 Prohibitive Action	 Mandatory Action
--	--	--

WARNING

 The radar antenna sends the electromagnetic radio frequency (RF) energy. This energy can be dangerous to you, especially your eyes. Do not look at the radiator or near the antenna when the antenna is rotating.

The distances at which RF radiation levels of 100 W/m² and 10 W/m² exist are shown in the table.

Antenna Model	Distance to 100 W/m ² point	Distance to 10 W/m ² point
DRS2D	-	0.4
DRS4D	0.1	1.4
DRS4A	-	1.2
DRS6A	-	1.2
DRS12A w/XN12A	0.2	2.4
DRS12A w/XN13A	0.2	1.9
DRS25A w/XN12A	0.5	5.3
DRS25A w/XN13A	0.4	4.4

WARNING

 **Check that no person is near the radar antenna before you turn on the radar.**





Serious injury or death can occur if a person is hit by a rotating radar antenna.







 **Turn off the power immediately at the switchboard if water leaks into the equipment or smoke or fire is coming from the equipment.**

Failure to turn off the equipment can cause fire or electrical shock.

 **Do not open the equipment.**

Only qualified persons can work inside the equipment.

 WARNING	
	<p>Keep units other than the radar antenna away from the rain and water.</p> <p>Fire or electrical shock can occur if water gets inside the equipment.</p>
	<p>Do not disassemble or modify the equipment.</p> <p>Fire or electrical shock can occur if the equipment is disassembled or modified.</p>
	<p>Do not operate the equipment with wet hands.</p> <p>Electrical shock can occur.</p>

 WARNING	
	<p>Do not depend on one navigation device for the navigation of the vessel.</p> <p>Always check your position against all available aids to navigation, for the safety of vessel and crew.</p>
	<p>A radar is an excellent anti-collision aid, but remember to keep watch for possible collision conditions.</p> <p>Always keep a watch while underway.</p>
	<p>Do not leave any objects near the radar antenna.</p> <p>Fire, electrical shock or injury can occur if something gets caught in the radar antenna.</p>
	<p>Use the correct fuse.</p> <p>A wrong fuse can cause fire or serious damage to the equipment.</p>
	<p>Do not maneuver the vessel only from the depth indication.</p> <p>Grounding can occur.</p>

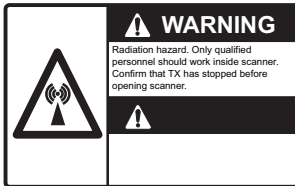

Name: Warning Sticker
 Type: 3-142-3201-0
 Code No.: 100-266-890

TABLE OF CONTENTS

FOREWORD	xi
SYSTEM CONFIGURATION	xiii
1. SYSTEM INTRODUCTION	1-1
1.1 The NavNet 3D System	1-1
1.1.1 How to sleep the equipment.....	1-2
1.2 Controls.....	1-2
1.2.1 Control Description.....	1-3
1.3 Power ON and OFF	1-5
1.4 Panel Dimmer, Display Brilliance	1-5
1.5 How to Select a Display	1-6
1.6 SD Cards.....	1-7
1.7 Chart Plotter Introduction	1-8
1.8 Radar Introduction.....	1-9
1.9 Fish Finder Introduction	1-10
1.10 The Cursor	1-11
1.11 Status Bar	1-12
1.12 RotoKey™ and Soft Controls.....	1-13
1.13 Pop-up Menus.....	1-14
1.14 Data Boxes.....	1-15
1.15 Menu Introduction	1-16
1.16 Language	1-19
1.17 Boat Icon.....	1-20
1.18 Man Overboard (MOB).....	1-21
1.19 Facsimile Receiver FAX-30.....	1-23
1.20 AIS Transponder FA-30, FA-50	1-24
1.21 DSC Message Information	1-25
1.21.1 How to Show, Hide DSC Message Information	1-25
1.21.2 How to Find DSC Information	1-25
1.21.3 Operations Available with the DSC Marker.....	1-26
1.21.4 The DSC List.....	1-26
2. CHART PLOTTER	2-1
2.1 Charts.....	2-1
2.1.1 Chart Description	2-1
2.1.2 How to Select a Chart Type	2-1
2.2 Chart Scale	2-4
2.3 Orientation Mode.....	2-5
2.4 How to Move the Chart	2-5
2.5 The Boat Icon.....	2-6
2.6 How to Find the Range and Bearing to a Location	2-8
2.7 Chart Object Information	2-8
2.8 Multiple Chart Plotter Displays	2-9
2.9 Cartographic Text and Objects on Vector Charts	2-10
2.9.1 Control Visibility of Text and Object Information	2-10
2.9.2 Control Visibility of Cartographic Objects.....	2-11
2.10 Alarms.....	2-13
2.10.1 XTE Alarm.....	2-13
2.10.2 Anchor Watch Alarm	2-13
2.10.3 Proximity Alarm	2-14
2.10.4 Depth Alarm	2-14
2.10.5 SST Alarm.....	2-14

2.10.6	Speed	2-14
2.10.7	Trip Log Alarm	2-14
2.10.8	Countdown Timer	2-14
2.10.9	Alarm Clock	2-14
2.10.10	How to Set an Alarm	2-15
2.10.11	Internal/External Alarm	2-16
2.10.12	Alarm Audio Options	2-16
2.10.13	Alarm Log	2-17
2.11	Track.....	2-18
2.11.1	How to Show or Hide the Track Display	2-18
2.11.2	Track Recording Method, Interval	2-18
2.11.3	Track Thickness	2-19
2.11.4	Track Color	2-20
2.11.5	How to Clear the Active Track	2-22
2.11.6	How to Save Active Track	2-22
2.11.7	How to Replay a Saved Track	2-23
2.11.8	How to Remove a Replayed Track.....	2-23
2.11.9	How to Find Information About a Track.....	2-24
2.11.10	Track Pop-up Menu	2-24
3.	3D DISPLAY, OVERLAYS	3-1
3.1	3D Display	3-1
3.1.1	Aerial View	3-1
3.1.2	Underwater Display	3-3
3.1.3	Highway Display	3-3
3.1.4	How to Make the 3D View Clearer	3-4
3.2	Overlays	3-5
3.2.1	Depth Shading Overlay	3-5
3.2.2	Weather Overlays.....	3-6
3.2.3	Satellite Photo Overlay	3-10
3.2.4	Animation Overlay	3-10
3.2.5	Radar Overlay	3-11
3.2.6	Tidal Information Overlay	3-12
3.2.7	Tidal Current Overlay	3-14
4.	POINTS	4-1
4.1	About Points	4-1
4.2	How to Mark a Point	4-2
4.2.1	How to Mark a Point at Current Position	4-2
4.2.2	How to Mark a Point at Cursor Position	4-2
4.2.3	How to Mark a Point from the Points List	4-3
4.3	How to Find Information About an On-screen Point.....	4-4
4.4	Default Point Settings	4-5
4.5	How to Move a Point	4-6
4.5.1	How to Move an On-screen Point	4-6
4.5.2	How to Move a Point from the Points List	4-6
4.6	How to Delete a Point.....	4-7
4.6.1	How to Delete a Point on the Screen	4-7
4.6.2	How to Delete a Point from the Points List.....	4-7
4.6.3	How to Delete All Points.....	4-7
4.7	How to Edit a Point from the Points List	4-8
4.8	How to Find a Point	4-10
4.8.1	How to Show a Point at the Center of the Screen.....	4-10
4.8.2	How to Find the Location of a Point from the Points Menu	4-10
4.9	Point Groups.....	4-10
4.10	How to Show or Hide All Points.....	4-11

TABLE OF CONTENTS

4.11	How to Go to a Point.....	4-12
4.11.1	How to go to an On-screen Point.....	4-12
4.11.2	How to go to Cursor Position.....	4-13
4.11.3	How to go to a Point Selected from the Points List.....	4-15
4.11.4	How to Extend a Route Made with a Single Point.....	4-15
4.12	How to Restart and Cancel Navigation to a Point.....	4-16
4.12.1	Restart Navigation.....	4-16
4.12.2	How to Cancel Navigation to a Point.....	4-16
5.	ROUTES.....	5-1
5.1	What is a Route?.....	5-1
5.2	How to Create a Route.....	5-2
5.2.1	How to Create a New Route.....	5-2
5.2.2	How to Insert a Point on a Route.....	5-3
5.2.3	How to Delete a Point.....	5-3
5.2.4	How to Extend a Route.....	5-4
5.2.5	How to Split a Route.....	5-4
5.2.6	How to Join Two Routes.....	5-5
5.3	Routes List.....	5-6
5.4	How to Find Information About a Route on the Screen.....	5-7
5.5	How to Find a Route on the Chart.....	5-7
5.6	How to Change the Name of a Route.....	5-8
5.7	How to Delete a Route.....	5-8
5.7.1	How to Delete an Individual Route.....	5-8
5.7.2	How to Delete All Routes.....	5-8
5.8	How to Show or Hide All Routes.....	5-9
5.9	How to Follow a Route.....	5-9
5.9.1	How to Follow an On-screen Route.....	5-9
5.9.2	How to Follow a Route Selected from the Routes List.....	5-10
5.9.3	How to Start Navigation from a Point.....	5-10
5.9.4	How to Show Information About a Route.....	5-11
5.9.5	Flyover.....	5-11
5.10	Operations When You Follow a Route.....	5-12
5.10.1	Restart Navigation.....	5-12
5.10.2	Follow a Route in the Reverse Direction.....	5-12
5.10.3	Stop Following a Route.....	5-13
5.10.4	Skip a Leg on a Route.....	5-13
5.10.5	Waypoint Switching Mode.....	5-14
5.10.6	Route Auto Zoom.....	5-15
5.10.7	XTE Alarm Lines.....	5-15
5.10.8	Waypoint Arrival Notification.....	5-16
5.11	Navigation Calculator.....	5-16
6.	RADAR.....	6-1
6.1	How to Transmit, Set the Radar in Stand-by.....	6-1
6.2	How to Adjust the Gain.....	6-2
6.3	How to Reduce Sea Clutter.....	6-3
6.4	How to Reduce Rain Clutter.....	6-4
6.5	Range Scale.....	6-5
6.6	Orientation Mode.....	6-6
6.6.1	Description of Orientation Modes.....	6-6
6.7	How to Measure the Range to a Target.....	6-8
6.7.1	How to Display the Range Rings.....	6-8
6.7.2	How to Measure the Range with a VRM.....	6-8
6.7.3	How to Deactivate a VRM.....	6-9
6.8	How to Measure the Bearing to a Target.....	6-10

6.8.1	How to Measure the Bearing with an EBL.....	6-10
6.8.2	How to Erase an EBL	6-11
6.8.3	How to Select True or Relative Bearing	6-11
6.9	How to Off-center the Picture	6-12
6.10	Heading Line	6-13
6.11	How to Reduce Radar Interference	6-14
6.12	Guard Alarm	6-15
6.12.1	How to Set a Guard Zone.....	6-15
6.12.2	How to Activate or Deactivate a Guard Zone	6-16
6.12.3	How to Erase a Guard Zone.....	6-16
6.13	Watchman	6-16
6.14	Echo Trails.....	6-17
6.14.1	How to Hide or Show Echo Trails.....	6-17
6.14.2	How to Clear Echo Trails to Start New Trails	6-17
6.14.3	Echo Trail Time	6-17
6.14.4	Echo Trail Reference.....	6-18
6.14.5	Echo Trail Color.....	6-18
6.14.6	Echo Trail Style	6-18
6.15	Echo Stretch	6-19
6.16	Echo Average	6-19
6.17	Automatic Shift	6-20
6.17.1	How to Set Auto Shift Speed.....	6-20
6.17.2	How to Activate or Deactivate Auto Shift.....	6-20
6.18	Sweep Fade	6-20
6.19	How to Show, Hide, Cancel an Active Route	6-21
6.20	How to Show or Hide the Boat Icon.....	6-21
6.21	Echo Color.....	6-22
6.22	Background Color.....	6-22
6.23	Radar Overlay Range Link	6-22
6.24	Dual-Range Display.....	6-23
6.25	FAR-2107 Radar Series and NavNet 3D.....	6-24
6.26	How to Understand the Radar Display	6-25
6.26.1	False Echoes.....	6-25
6.26.2	Search and Rescue Transponder (SART)	6-27
6.27	ARPA Operation	6-29
6.27.1	How to Show or Hide the ARPA Display	6-29
6.27.2	How to Manually Acquire a Target	6-30
6.27.3	How to Display Target Data	6-31
6.27.4	How to Stop Tracking Targets.....	6-31
6.27.5	How to Clear a Lost Target	6-31
6.27.6	CPA/TCPA Alarm	6-32
6.27.7	How to Set an ARPA Acquisition Area	6-33
6.27.8	Track History Display	6-34
7.	FISH FINDER.....	7-1
7.1	How the Fish Finder Operates.....	7-1
7.2	How to Select a Display.....	7-2
7.2.1	Single Frequency Display.....	7-2
7.2.2	Dual Frequency Display	7-3
7.2.3	Zoom Displays.....	7-4
7.2.4	A-scope Display (display only)	7-6
7.2.5	Bottom Discrimination Display.....	7-7
7.3	Automatic Fish Finder Operation.....	7-9
7.3.1	How the Automatic Fish Finder Operates	7-9
7.3.2	How to Select an Automatic Fish Finder Mode	7-9
7.4	Manual Fish Finder Operation.....	7-10

TABLE OF CONTENTS

7.4.1	How to Select the Manual Mode	7-10
7.4.2	How to Select a Display Range	7-10
7.4.3	How to Shift the Range	7-10
7.4.4	How to Adjust the Gain	7-11
7.4.5	How to Reduce Clutter	7-11
7.5	Picture Advance Speed	7-12
7.6	How to Reduce Interference	7-13
7.7	How to Measure Depth, Time Between Locations	7-14
7.8	How to Erase Weak Echoes	7-15
7.9	How to Balance Echo Strength	7-16
7.10	White Marker	7-17
7.11	Fish Finder Alarms	7-17
7.11.1	How to Set an Alarm	7-17
7.11.2	How to Activate or Deactivate an Alarm	7-18
7.11.3	Alarm Sensitivity	7-18
7.12	ACCU-FISH™	7-19
7.12.1	How to Set ACCU-FISH™	7-20
7.12.2	Fish Size Correction	7-21
7.13	Water Temperature Graph	7-21
7.14	Fish Finder Menu Operation	7-22
7.14.1	Fish Finder-General Menu	7-22
7.14.2	Fish Finder-DFF1/BBDS1/DFF1-UHD, -DFF3/FCV, -ETR-6/10N and -ETR-30N Menus	7-23
7.15	NavNet 3D and LCD Color Sounder FCV-1150	7-25
7.16	Interpreting the Display	7-27
8.	FILE OPERATIONS	8-1
8.1	How to Format SD Cards	8-1
8.2	Files Menu Operation	8-1
8.2.1	Files Menu Description	8-2
8.3	How to Export Tracks, Points and Routes, User Setup	8-3
8.4	How to Import Tracks, Points and Routes, User Setup	8-4
8.5	How to Delete Files	8-4
9.	CAMERA/VIDEO	9-1
9.1	How to Display a Video Image	9-1
9.2	How to Set the Video Display	9-2
9.2.1	How to Select the Input Source	9-2
9.2.2	How to Cycle Your Video Inputs	9-2
9.2.3	How to Set the Cycle Period	9-3
9.3	How to Show Video ID	9-3
9.4	How to Adjust the Video Image	9-4
9.5	How to Control an Axis IP Camera	9-4
10.	INSTRUMENT DISPLAY	10-1
10.1	How to Prepare the Hot Page	10-2
10.2	How to Show the Instrument Display	10-2
10.3	How to Select an Instrument Display	10-3
10.4	Instrument Displays	10-3
10.4.1	Steering Display	10-3
10.4.2	Engine Display	10-4
10.4.3	Wind and Weather Display	10-5
10.4.4	True Wind Display	10-6
10.4.5	Apparent Wind Display	10-6
11.	SIRIUS WEATHER RECEIVER	11-1

11.1	Weather Display Introduction	11-1
11.2	Weather Icons	11-2
11.3	Weather Menu	11-3
11.3.1	How to Display the Weather Menu	11-3
11.3.2	Weather Menu Description	11-4
11.4	Weather Reports	11-12
11.4.1	Marine Zone Forecast	11-12
11.4.2	Marine Warning	11-13
11.4.3	Tropical Weather Statement.....	11-13
11.4.4	Marine WatchBox	11-14
11.5	Sirius Satellite Radio	11-15
12.	AUTOMATIC IDENTIFICATION SYSTEM (AIS)	12-1
12.1	AIS Introduction	12-1
12.2	How to Show or Hide the AIS Display	12-1
12.3	AIS Target Symbols.....	12-2
12.4	Proximity AIS Target Alarm	12-2
12.5	How to Ignore AIS Targets	12-3
12.6	How to Display Target Data.....	12-4
12.7	Track History Display.....	12-4
12.8	How to Show and Hide Target IDs	12-4
13.	HOW TO ADJUST SETTINGS	13-1
13.1	RotoKey.....	13-2
13.1.1	How to Select the RotoKey Set to Use.....	13-5
13.1.2	How to Set the RotoKey	13-6
13.2	Data Boxes	13-7
13.2.1	How to Set the Data Boxes	13-7
13.2.2	How to Show or Hide all Data Boxes	13-9
13.2.3	How to Adjust Transparency of Data Boxes.....	13-9
13.3	How to Set the Display Selection Window.....	13-9
13.3.1	How to Set the Number of Hotpages to Show.....	13-9
13.3.2	How to Set a Hotpage	13-10
13.4	Global Menu	13-12
13.4.1	Global-General Menu	13-12
13.4.2	Global-Units Menu.....	13-14
13.5	System Menu.....	13-15
13.5.1	System-General Menu	13-15
13.5.2	System-Calibration Menu	13-16
13.5.3	System-Radar Menu	13-17
13.5.4	System-DFF1/BBDS1/DFF1-UHD, -DFF3/FCV Menu	13-18
13.5.5	System-ETR-6/10N Menu	13-19
13.5.6	System-ETR-30N Menu	13-20
13.6	My NavNet-General Menu.....	13-21
13.7	How to Control Charts	13-23
13.7.1	How to View Your Charts	13-23
13.7.2	How to Update Charts	13-24
13.7.3	How to Add a Chart	13-25
13.7.4	How to Delete a Chart	13-25
14.	MAINTENANCE, TROUBLESHOOTING	14-1
14.1	Maintenance	14-1
14.2	Fuses.....	14-2
14.3	The Magnetron	14-2
14.4	Troubleshooting.....	14-3
14.4.1	General Troubleshooting.....	14-3

TABLE OF CONTENTS

14.4.2 Radar Troubleshooting.....	14-3
14.4.3 Chart Plotter Troubleshooting	14-4
14.4.4 Fish Finder Troubleshooting	14-4
14.5 GPS Status Display.....	14-5
APPENDIX 1 MENU TREE	AP-1
SPECIFICATIONS	SP-1
INDEX.....	IN-1

FOREWORD

A Word to the Owner of the MFD8, MFD12

Congratulations on your choice of the MFD8, MFD12 Multi Function Display, an integral part of our new NavNet 3D series of multi-function displays. We are confident you will see why the FURUNO name has become synonymous with quality and reliability.

Since 1948, FURUNO Electric Company has enjoyed an enviable reputation for innovative and dependable marine electronics equipment. This dedication to excellence is furthered by our extensive global network of agents and dealers.

Your equipment is designed and constructed to meet the rigorous demands of the marine environment. However, no machine can perform its intended function unless properly installed and maintained. Please carefully read and follow the operation and maintenance procedures set forth in this manual.

We would appreciate feedback from you, the end-user, about whether we are achieving our purposes.

Thank you for considering and purchasing FURUNO.

Features

The NavNet 3D series is a networked navigation system that gives you radar, chart plotter, fish finder, AIS receiver, etc. Information is transferred between NavNet 3D units through a lightning fast Ethernet. The plug and play format allows expansion and you can connect a maximum of 10 NavNet devices.

The RotoKey™, a rotary knob that controls an on-screen, turning menu of soft controls, gives you fast access to full control of NavNet 3D.

Chart plotter

- TimeZero™ technology displays charts immediately with no load time.
- Loaded with full scale, complete Mapmedia NOAA raster and vector charts for all the United States.
- 3D display with controls for pitch and orientation.
- Way points, routes, tracks, etc. are transferred between NavNet 3D units through the Ethernet.
- Large memory stores 10,000 track points, 2,000 way points, and 200 routes.
- The overlay displays show depth shading, tide, tidal current, and satellite photo (North America only).

Radar sensor (option)

- The radar antenna are in radome or open-array type.
- The radar echoes appear in color or monochrome.
- Automatic control of sea clutter, tuning and gain for easier operation.
- Guard zone checks for targets within the area you indicate.
- ARPA provided standard.
- Dual-range display for watch on short and long distances at the same time.

FOREWORD

- Compliant with IEC 62252 Ed.1:2004 (Clauses 4.33, 5.33, Annex D)

Fish finder (option)

- Measures the depth to the bottom and displays underwater conditions in multi-colors according to echo strength. A monochrome presentation shows the echoes in shades of gray.
(*Number of colors depends on network sounder, color sounder.)
- The zoom mode enlarges the targets.
- Automatic and manual operation. Auto mode automatically adjusts range, gain and clutter according to purpose, fishing or cruising.
- ACCU-FISH™ estimates length and depth of individual fish.
(Requires appropriate transducer and Bottom Discrimination Sounder BBDS1, Network Sounder DFF series, or LCD Color Sounder FCV-1150.)
- The bottom discrimination display helps identify probable bottom composition. (Requires Bottom Discrimination Sounder BBDS1.)

Other

- The AIS function receives AIS data from other vessels, shore stations and navigational aids and displays this data.
- The DSC (Digital Selective Calling) message information feature provides the MMSI no. and position of ships that have transmitted a DSC message to you. (Requires DSC capable radiotelephone.)
- USB port connects the plug and play USB devices (mouse, etc.).
- Instrument displays (steering, engine, weather, and wind) with connection of the correct sensors:
- The weather information display available with connection of Sirius weather receiver.
- The Sensor data is transferred to units through the Ethernet.
- IP camera (local supply) monitors activity on the vessel.
- NMEA 2000 interface for the connection of GPS receiver, Weather Station, FI-50 (instrument series), SATELLITE COMPASS™, etc.
- 100 Megabit per second transfer rate.

Program No.

1950055-02.**

** denotes minor modifications.

CE declaration

With regards to CE declarations, please refer to our website (www.furuno.com), for further information about RoHS conformity declarations.

SYSTEM CONFIGURATION

MFD8

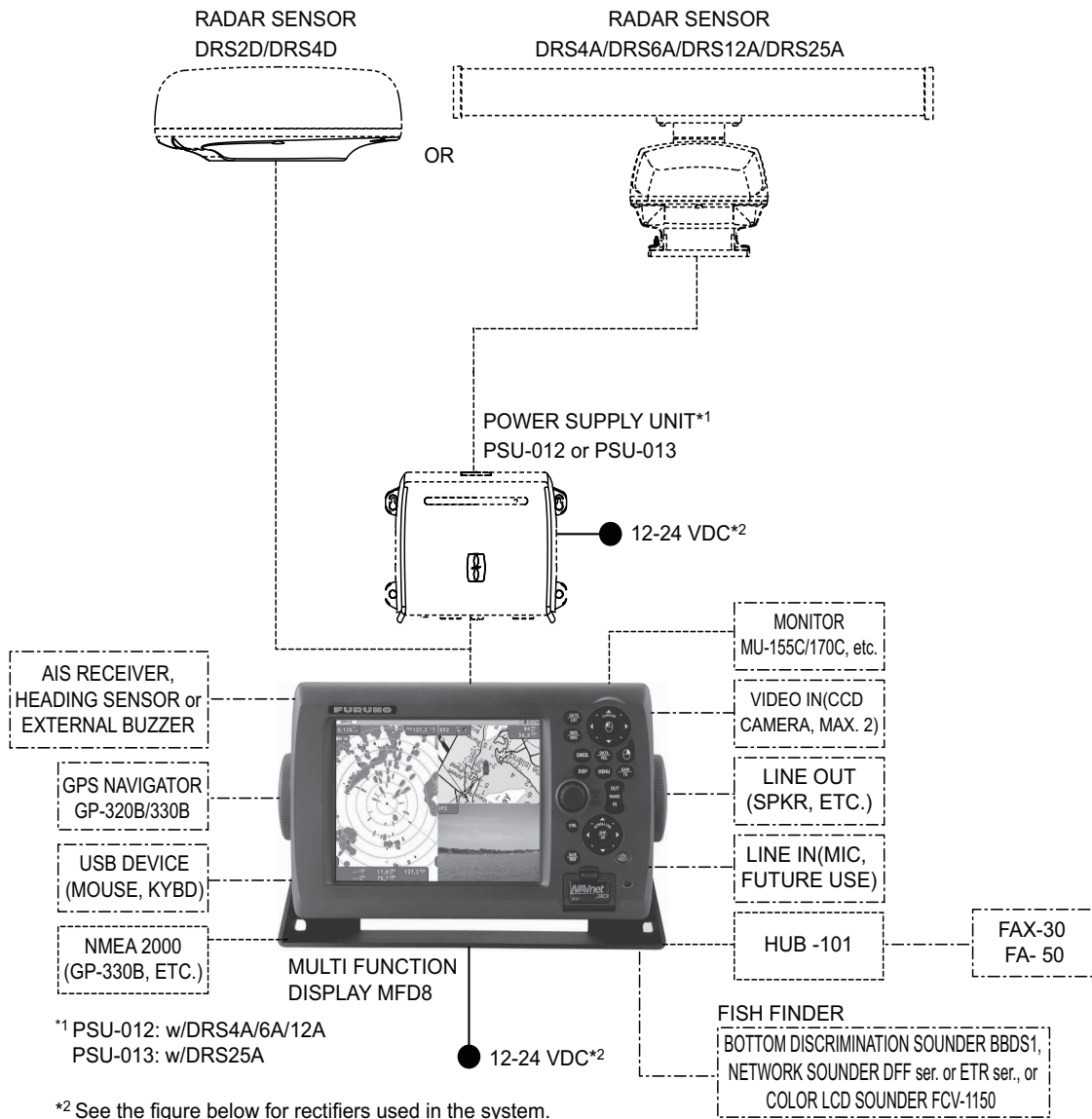

Rectifiers used in the system

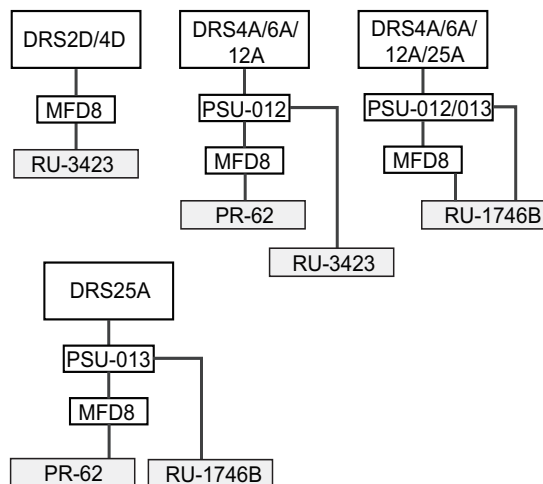

SYSTEM CONFIGURATION

MFD12

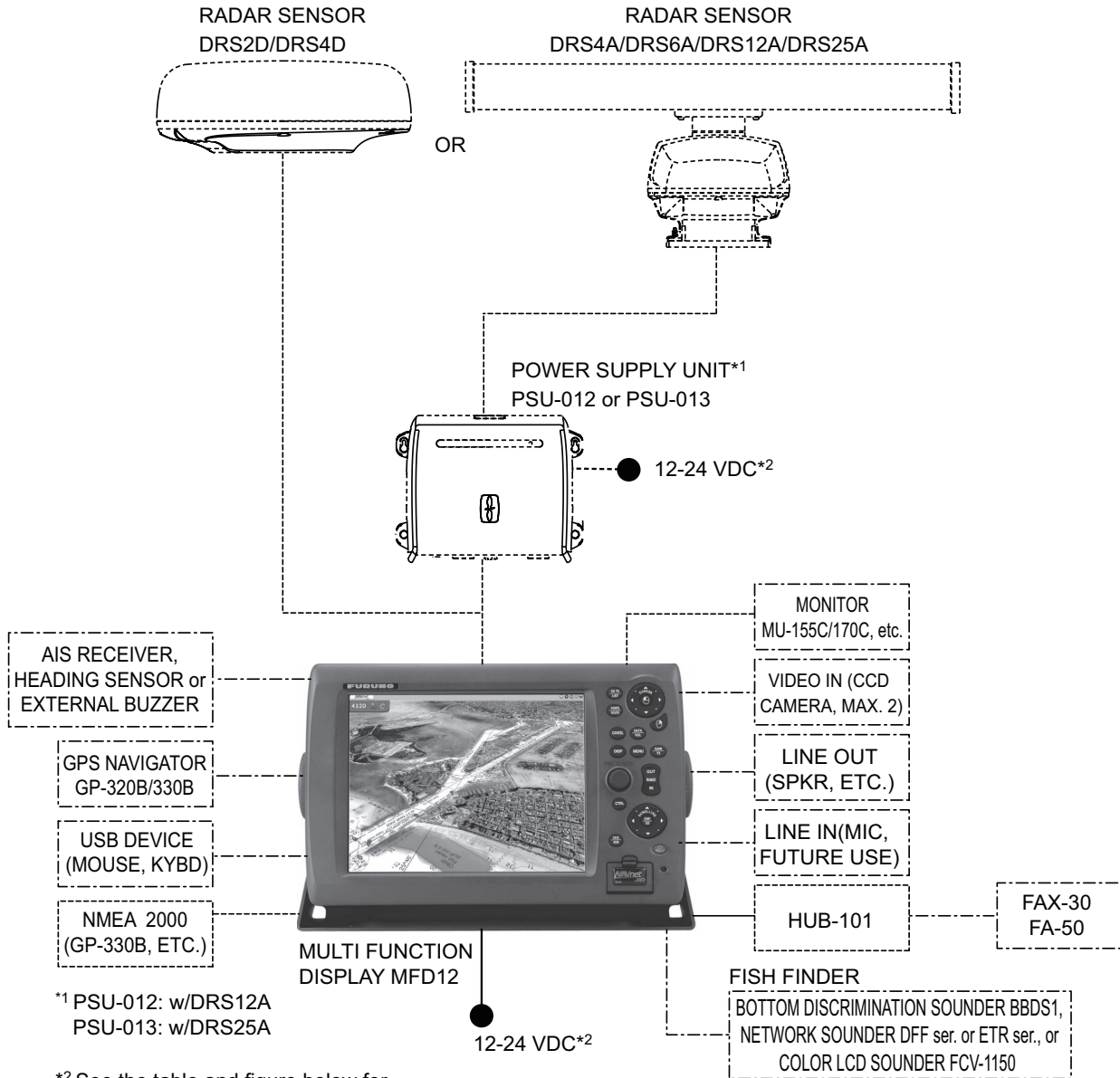

*1 PSU-012: w/DRS12A
PSU-013: w/DRS25A

*2 See the table and figure below for rectifiers used in the system.

—— : Standard Supply
 - - - - : Optional Supply
 - · - · - : Local Supply

Rectifiers used in the system

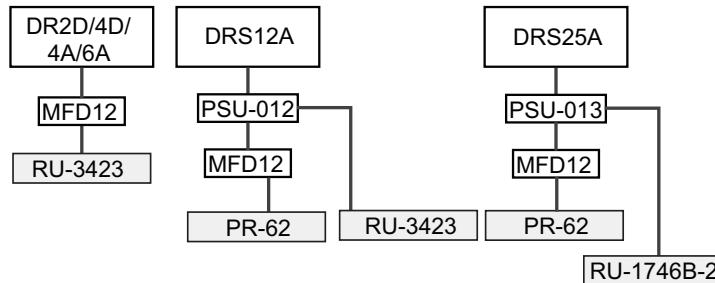

1. SYSTEM INTRODUCTION

This chapter provides the information necessary to get you started using your system. Some of the topics are how to turn on the equipment and an introduction to the main displays.

Standards used in this manual

- The keys and controls on the control panel are shown in bold face, for example the **DISP** key. Other items that have a label, for example, the soft controls related to the **RotoKey**, are shown in brackets in normal typeface. For example, [Head Up].
- The **RotoKey** controls the "soft controls", a revolving set of soft controls that gives you access to full control of the NavNet 3D system. You rotate the **RotoKey** to select a soft control then push the **RotoKey** to do the function marked on the soft control. This manual states this operation procedure as "Use the **RotoKey** to select [menu item name or soft control name]."
Note: RotoKey is a registered trademark or trademark of FURUNO Electric Co., Ltd.
- The menu system has a maximum of 15 menus and related sub menus. When you are asked to open a menu, the name of the menu and sub menu are given, separated by a hyphen. For example, "Open the [Routes-General] menu".
- There is more than one method to do a function, Key operation, pop-up menu and **RotoKey**.

1.1 The NavNet 3D System

The NavNet 3D network is a system where all parts use the same information (navigation data, settings, points, routes, etc.). Each unit in the system displays information from other units and NMEA devices, like GPS navigator. Information is transferred between MFDs through a high-speed Ethernet.

Each MFD has a special "sleep mode" that allows each MFD to operate while using low power. The MFDs can be in three states:

- **ON:** Normal mode of operation. The screen is on and the user can operate the MFD. The MFD operates and transfers information across the network.
- **Sleep Mode:** The screen is turned OFF and only the power switch operates (to turn the power OFF). The MFD in this state can process controls and transfer information with other MFDs on the network. The MFD uses low current in this state.
- **OFF:** The MFD is turned OFF and does not control information. The MFD does not use any current in this state.

When power is applied to an MFD (with the power switch), all the other MFDs start in the sleep mode. If you operate the power switch on an MFD that is in the sleep mode, the MFD turns on. If you press the power switch on an MFD more than three seconds, all MFDs in the network are turned OFF.

Note: If you press a power switch more than 5-7 seconds, all MFDs turn OFF and power synchronization is lost. To restore power synchronization, first turn off all MFDs.

1. SYSTEM INTRODUCTION

Then, hold down the power switch of the MFD that was responsible for loss of power synchronization for three seconds.

1.1.1 How to sleep the equipment

You can sleep the equipment when its use is not required continuously. With the Standard or Full RotoKey set active, push the **RotoKey**, rotate the key to select [Sleep] then push the key. To un-sleep the equipment, push the power key until the picture appears.

1.2 Controls

The controller for this system is either the MFD8 or MFD12.

A key that has two text labels separated by a line has two functions. The top label is the main function and the bottom label, the secondary function. Short-push to access the main function and long-push (approximately three seconds) to access the secondary function.

You operate the chart plotter, radar, fish finder, etc. with

- Keys
- CursorPad
- ScrollingPad
- **RotoKey**
- Menus, where you select options
- Pop-up menus, where you select options
- Lists, where you can edit items

When you operate a key, a single beep sounds to tell you correct operation. For wrong operation, three beeps sound. If you do not need the key beep, deactivate the beep sound from the [Global-General] menu.

1.2.1 Control Description

The controls of your system are in the figure shown below. Controls are illuminated for nighttime use.



Model MFD8





Model MFD12

Control description

No.	Label	Function	Mouse operation
1	 BRILL	Short-push: Turn ON the power. Adjust the panel dimmer. Long-push: Turn the power OFF.	-
2	Card drive	Card drive for memory cards.	-
3	SAVE/MOB	SAVE: Save the current position as a point. MOB: Save the current position as a MOB position.	-
4	CTRL	Select the active display in combination displays.	-

1. SYSTEM INTRODUCTION

No.	Label	Function	Mouse operation
5	RotoKey	<ul style="list-style-type: none"> • Rotate to display soft controls, the quantity (basic, standard, full or custom) of which you select from the menu, or select the menu item. • Short-push to display soft controls, the quantity (basic, standard, full or custom) of which is indicated on the menu, or validate a selection. • Long-push to display all available soft controls for the current mode. 	Scrollwheel. Spin to display soft controls or select item. Push to validate selection.
6	DISP	Select a display.	-
7	CANCEL	Undo or cancel last operation.	-
8	POINTS/ ROUTE	POINTS: Save the cursor position as a point. ROUTE: Activate the route building tool.	-
9	GO TO/LIST	GO TO: Set the cursor position as the destination. LIST: Open the Points menu.	-
10	CursorPad	<ul style="list-style-type: none"> • Pad: Move the cursor. •  Functions like the "left-click" button on a PC mouse. This button has the name "left-click" button in this manual. 	<ul style="list-style-type: none"> • Move the cursor. • Left mouse button
11	 (right-click button)	Show a pop-up menu. This button has the name " right-click " button in this manual.	Right mouse button
12	DATA/VOL	DATA: Show and hide the data boxes. VOL: Change audio level. If you have the Sirius weather receiver, the Sirius satellite radio screen appears.	-
13	MENU	Open and close the menu.	-
14	GAIN/TX	GAIN: Adjust the gain for the radar and the fish finder. TX: Change between stand-by and transmit on the radar and fish finder.	-
15	RANGE OUT, IN	<ul style="list-style-type: none"> • Select range on the chart, radar and fish finder. • Zoom in and zoom out the Axis IP camera image. 	-
16	ScrollingPad	<ul style="list-style-type: none"> • Pad: Scroll the chart, radar picture and AXIS IP camera image. • SHIP/3D button: Short-push to put your vessel at the center of the screen. Long-push to change between the 3D and 2D displays alternately. 	-
17	Power lamp	Lights when the power is applied to the system.	-

1.3 Power ON and OFF

Press  to turn the power ON. To turn the power OFF, press and hold the same key. The message "All Network Devices will shut down in Xm XXs" displays the amount of time remaining until power off.

When you turn on the power, two or three beeps sound and the lamp near the power switch lights. The start-up screen appears with the progress bar (at the bottom of the screen). The progress bar moves to the right as the procedure continues. Approximately 90 seconds after you apply the power, the Navigation Warning message appears. Read the message then push the **RotoKey** to begin operation. (There is an additional message if your NavNet has the Sirius weather feature.)

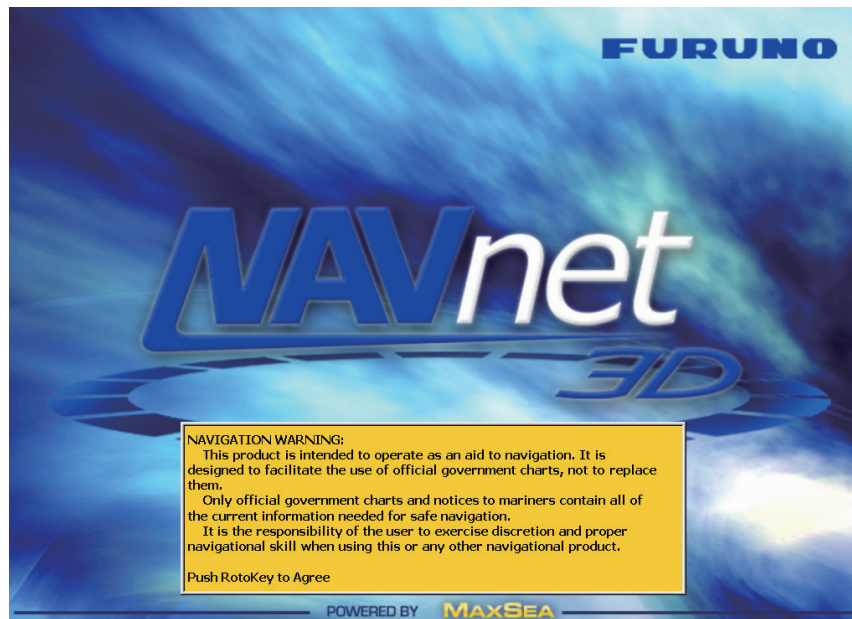

Note: Do not turn off the power during the start-up. Wait until the start-up is completed before you turn the power OFF.

1.4 Panel Dimmer, Display Brilliance

Adjust the illumination of the panel dimmer and the brilliance of the display as shown below.

- 1) Push the  key to display the [Brill/Dimmer] adjustment window.

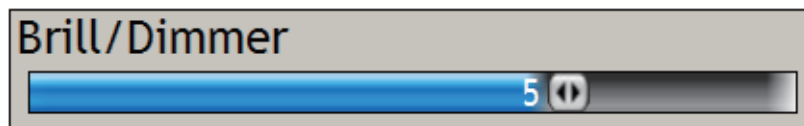

- 2) Rotate the **RotoKey** to adjust the panel dimmer and display brilliance. The current level is shown on the bar.
- 3) Push the **RotoKey** to validate the setting and close the window.

1.5 How to Select a Display

Use the **DISP** key and the **RotoKey** to select a display, from the display selection window. The displays available depend on your system configuration and the HotPage settings on the [My NavNet] menu. (You can change the display selection window according to your needs and system configuration.)

- 1) Press the **DISP** key to show the display selection window. (The labels in the illustration below do not appear on the display.)



Display selection window (example)

- 2) Rotate the **RotoKey** to put the required display in the "monitor" at the bottom of the screen.
- 3) Push the **RotoKey** to validate your selection.

How to select the active display in combination displays

Use the **CTRL** key to change the active display in combination displays. A thick red line is around the active display.



1.6 SD Cards

The SD card stores the tracks, routes, points, settings, etc. Set and remove SD cards as shown below. The recommended capacity for the cards is 128 MB to 2 GB. The Secure Digital High Capacity (SDHC) cards can also be used, and the maximum capacity is 32 GB.



How to format an SD card

You do not normally need to format an SD card for use with the system. If the card becomes damaged, format the card with a formatting program that is compatible with the specifications of the SD card. The SD Memory Card Formatting Software made by Panasonic is an example.

How to set an SD card

- 1) Pull the tab on the card drive cover to open the card drive.
- 2) As shown in the right-hand figure, put the SD card in either card drive with the label up. If the card does not set easily, do not use force.
- 3) Push the card until the card is in position.

How to remove an SD card

- 1) Pull the tab on the card drive cover to open the card drive.
- 2) Push the card to release the card from the card drive.
- 3) Remove the card with your fingers then close the cover.

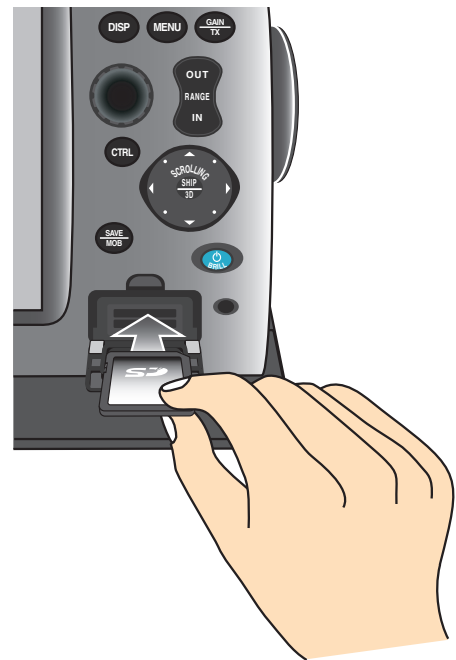

About the SD cards

- Use SD cards carefully. Wrong use can damage the card and destroy its contents.
- ***Make sure the cover is closed at all times.***
- Remove a card with only your fingers. Do not use metal instruments (like tweezers) to remove the card.
- Do not remove a card during the reading of the card or writing to the card. The power LED flashes when the system accesses an SD card.
- **If there is water at the bottom of the card cover, DO NOT open the cover. Remove the water with a dry cloth completely and then open the cover.**

1.7 Chart Plotter Introduction

The chart plotter provides a small world map in raster format. A vector chart for the US coastline (with Alaska and Hawaii) is provided also. The plotter section has functions to enter waypoints, and create and plan routes.

The chart plotter receives position information supplied from the position-fixing equipment like GPS or DGPS. Your position is marked on the screen with the boat icon. You can change the shape of the icon to match that of your vessel.

Waypoints and routes you have entered are shown on the display. You can move, delete and edit the waypoints and routes from a pop-up menu.

The chart plotter also

- Plots the track of your vessel
- Measures distances and bearings
- Marks man overboard (MOB) position
- Controls alarm functions
- Follows routes

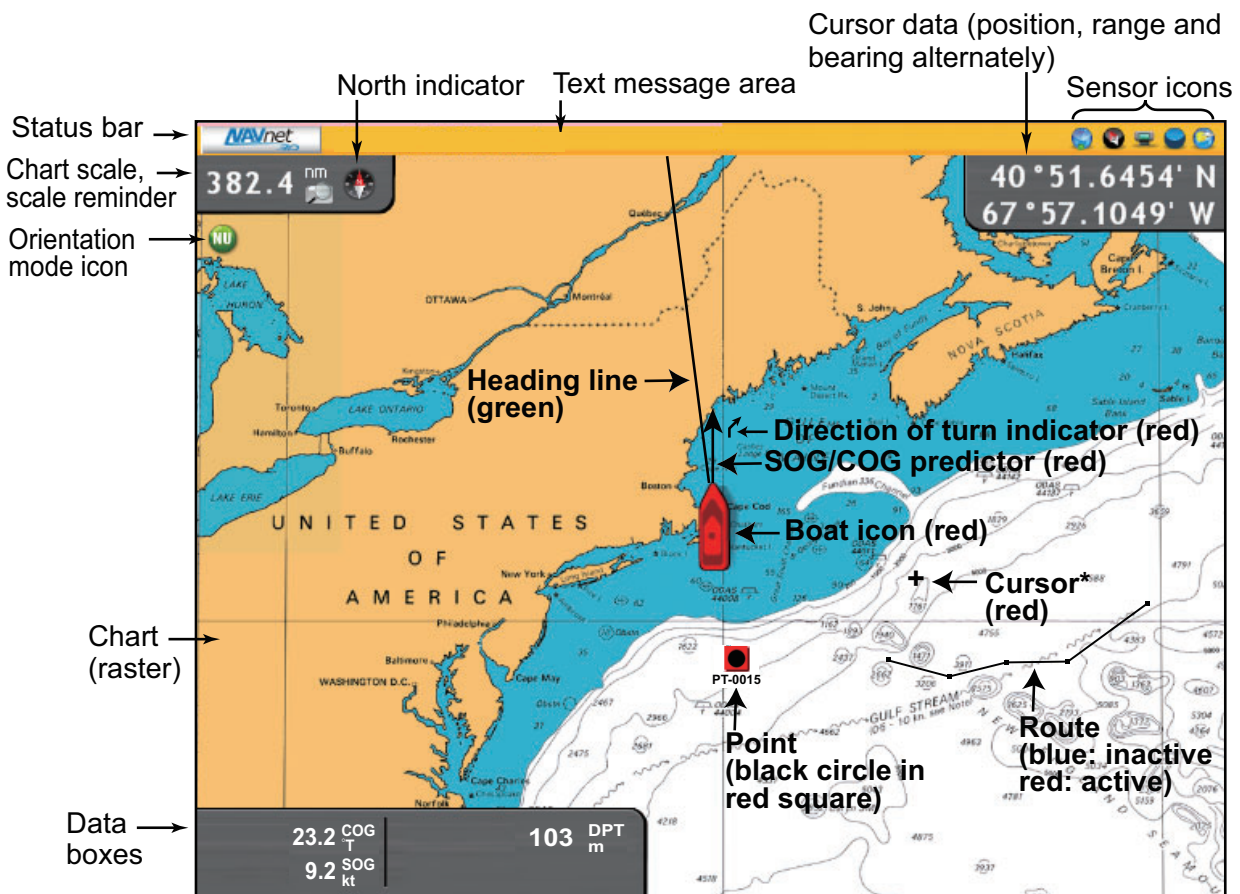

* Inactive cursor. Active cursor looks like this .

1.8 Radar Introduction

A radar system operates in the microwave part of the radio-frequency (RF) range. The radar detects the position and movement of objects. Objects are shown on the radar display at their measured distances and bearings in intensities according to echo strength.

The radar display is available in head-up, course-up and north-up modes and orientation in true and relative motion. The relative motion display shows other vessels movement relative to your vessel. The true motion display shows your vessel and other objects in motion according to their true courses and speeds.

Two VRMs measure the range to targets, and two EBLs measure the bearing to targets. A guard zone tells you when the radar targets are in the area you indicate. The trail of targets can be shown in afterglow to monitor their movements.

The dual-range display scans and displays two different radar ranges at the same time. This display lets you watch on both short and long ranges at the same time.

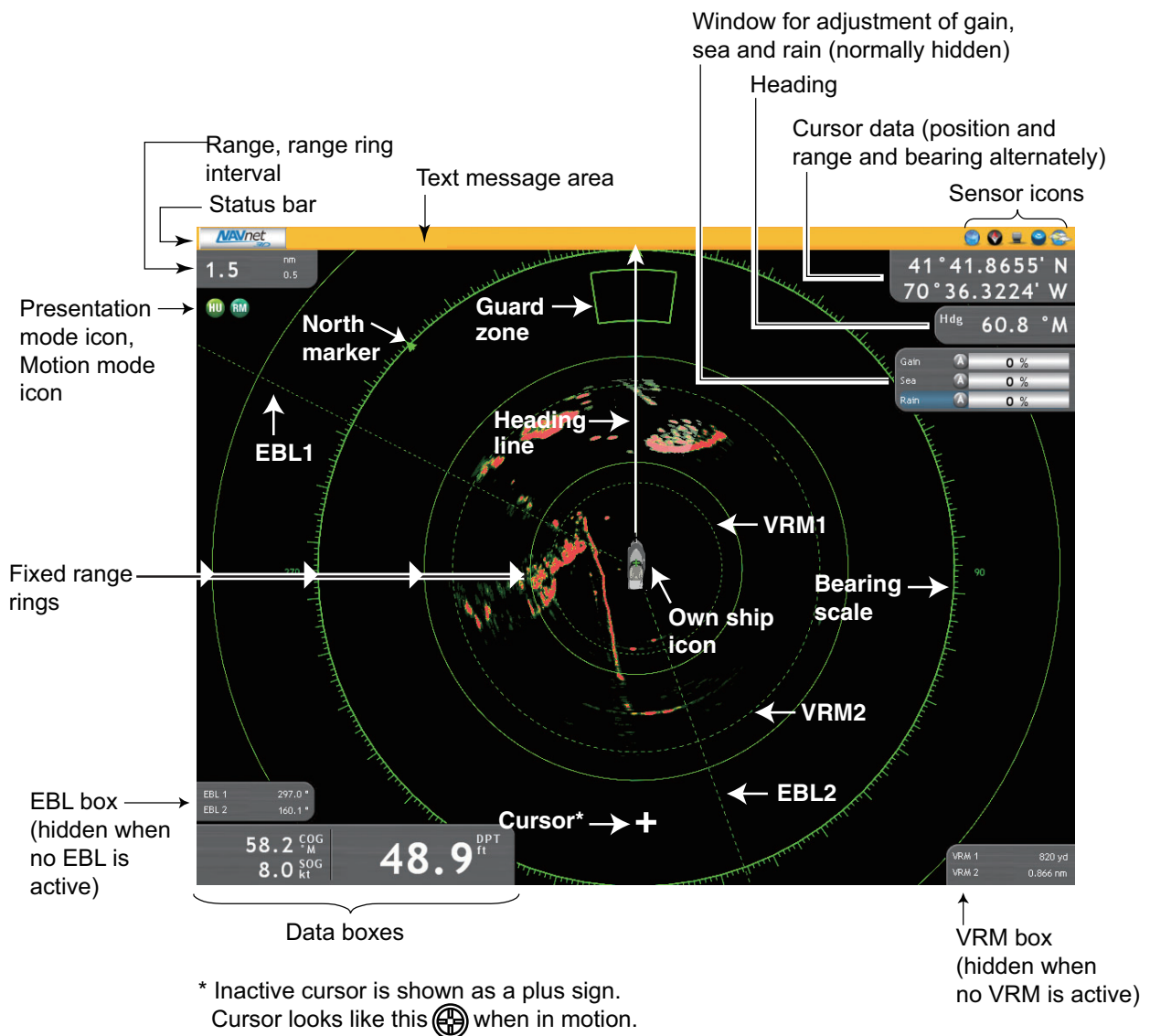

1.9 Fish Finder Introduction

The fish finder screen provides a “picture” of the echoes found by the fish finder. Echoes are scrolled across the screen from the right position to the left position. The number of minutes an echo is displayed on the screen is controlled by the picture advance speed.

The echoes at the right position are the current echoes. These echoes can be from separate fish, a school of fish, or the bottom. Depth to the bottom is indicated always, provided the gain is set correctly.

Both low and high-frequency TX frequencies are provided. (Frequencies depend on the transducer connected.) The low frequency has a wide detection area, which is for general detection and understanding bottom conditions. The high frequency has a narrow beam that helps you inspect fish.

The range, gain, clutter and TVG can be adjusted automatically according to your purpose (cruising or fishing) to let you do other tasks.

The color bar at the left edge of the display shows the range of colors used to display different echo strengths. Weaker echoes appear in colors near the bottom of the scale, and stronger echoes appear in colors near the top.

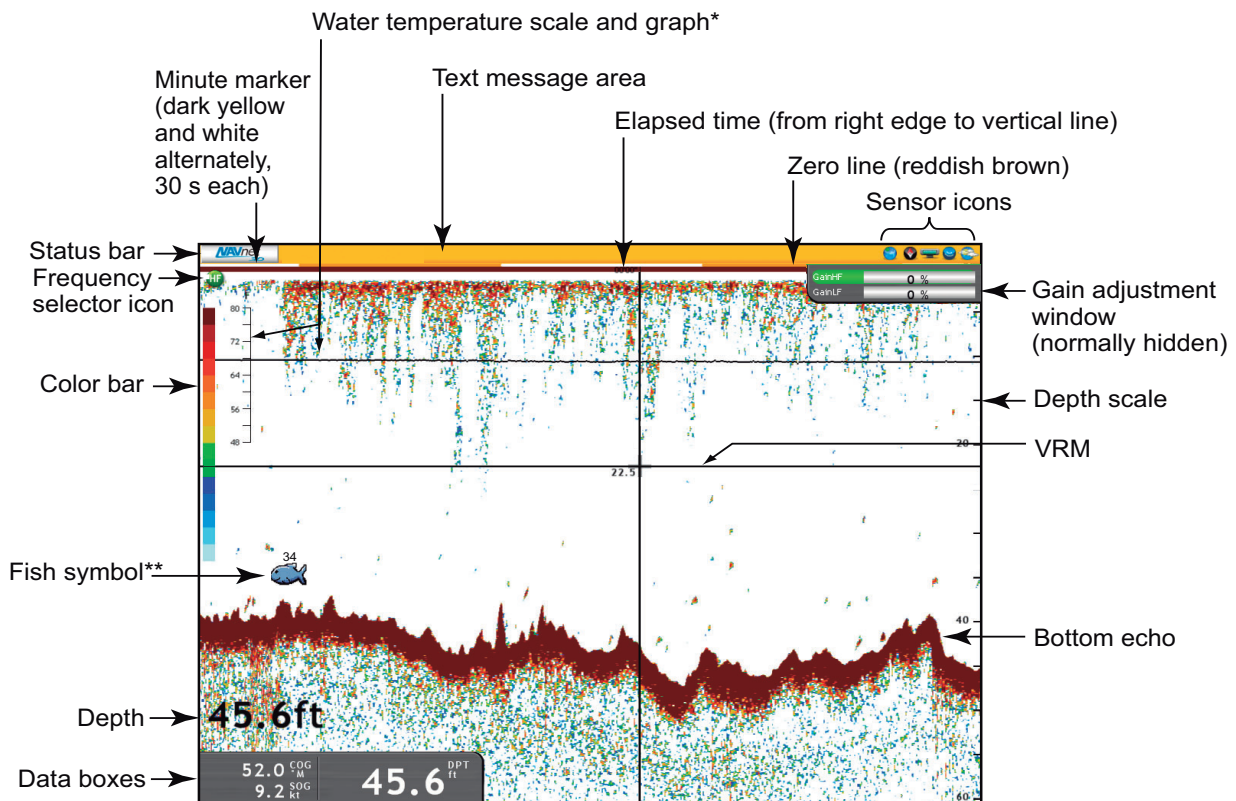

* Requires water temperature sensor.

**ACCU-FISH™ feature estimates length of individual fish.

(Requires appropriate transducer and Bottom Discrimination Sounder BBDS1, Network Sounder DFF series, or Color LCD Sounder FCV-1150.)

1.10 The Cursor

The cursor is always displayed on the radar, chart plotter and fish finder displays and has the functions shown below.

- Find the position, range and bearing to an object on the chart plotter and radar displays
- Find the depth to an object on the fish finder display.
- Select a position for a waypoint on the chart plotter display.
- Select an item. For example, a waypoint on the chart plotter display.

✚ : Inactive

⊕ : In motion

To move the cursor, press any of the four arrows on the CursorPad to the cursor the direction indicated on the arrow pressed. You can also move the cursor from one corner to the opposite corner when you press any two locations together on the Cursor-Pad. The cursor position and range and bearing from your vessel to the cursor position are alternately shown in the cursor data box at the upper right corner of the screen. (The chart plotter and radar displays only).

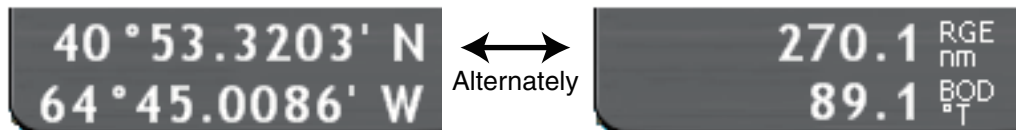

Cursor position and range and bearing to cursor

On the radar and chart plotter displays the cursor also provides a pop-up menu. For additional information, see section 1.13 "Pop-up Menus".

1.11 Status Bar

The status bar is the horizontal bar at the top of any display. This bar shows operation information with messages, and sensor state with the icons. The color of the bar changes according to the types of messages as shown below.

Bar color	Type of message
Red	Alarm messages
Green	Operation instructions
Yellow	Message of low value, or no message



The sensor icons at the far right position on the status bar show the state of the sensors connected. An icon is in “motion” if the related sensor is active. An icon is not moving and has an X if a sensor is not active or the sensor is not operating correctly. (The radar and fish finder icons are not in motion when the radar or fish finder is in stand-by.) The GPS, radar and fish finder icons have a “shortcut” function, Click those icons to get the shortcuts shown in the table.

Icon	Sensor	Right-or left-click
	GPS	Show the GPS status display. (See the section 14.5.)
	Compass	
	Radar	Change between stand-by and TX.
	Fish Finder	Change between stand-by and TX.
	Weather	

1.12 RotoKey™ and Soft Controls

The main function of the **RotoKey** is to display the [soft controls], a revolving menu of soft controls which change with operating mode. A short-push or rotation of the key accesses a set of the functions that you select at the [My NavNet] menu. The selections are [Basic], [Standard], [Full] and [Custom]. A long-push displays all of the soft controls for the current mode.

The soft controls automatically disappear from the screen if not operated within approximately six seconds. To erase the soft controls manually, press the **CANCEL** key.

The icon at the end of a soft control indicates soft control category:

- A left arrow within an icon indicates a multi-function soft control. Push the **RotoKey** to access the functions.
- An icon without an arrow indicates the ON/OFF status of the item shown on the soft control. The icon is green when the item is ON and gray when the item is OFF.
- There is no icon on a soft control if the control hides or shows a special display, for example, the tide graph.



Pictured: MFD12

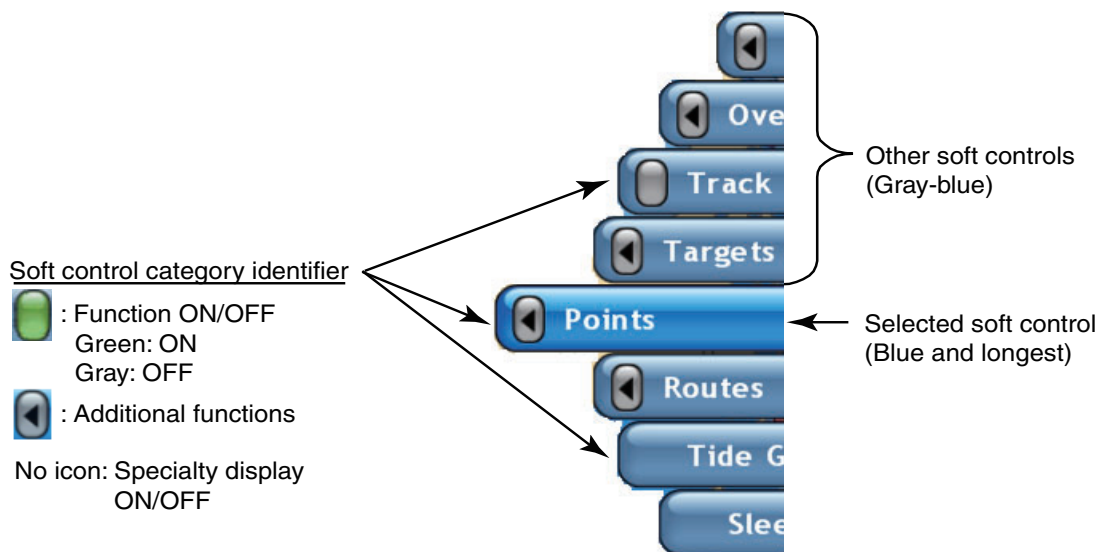

Example of soft controls for the chart plotter

To operate the soft controls:

Push or rotate the **RotoKey** to show the soft controls. Rotate the **RotoKey** to select a soft control. When you search through the soft control "menu", the now-selected soft control is blue and all other soft controls are gray. Push the **RotoKey** to do the function shown on the selected soft control.

1.13 Pop-up Menus

The pop-up menus let you quickly access the commands according to the selected object or active display. To display a pop-up menu, select an object and hit the **right-click** button. A pop-up can also be shown if you push the same button in any position on the active display. The illustration below shows the Radar pop-up menu.

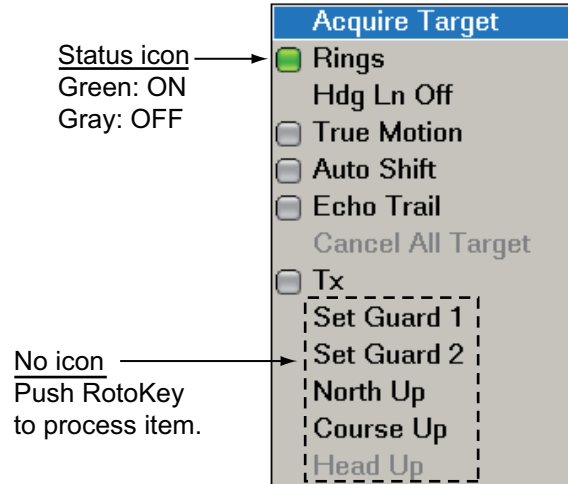

Radar pop-up menu

How to operate a pop-up menu:

Rotate the **RotoKey** to select an item. For a status icon, push the **RotoKey** to show the status icon in green to activate the function, or gray to deactivate the function. For items that do not have a status icon, push the **RotoKey** to go to the next level.

1.14 Data Boxes

The data boxes show the navigation data. You can select the data to display in the boxes, and show or hide the boxes as necessary. A box can show one or more data. Multiple data are scrolled according to the scrolling time set on the [DataBox] menu. The data that you can show depends on your system configuration. You can show a maximum of five boxes, four at the bottom-left corner and the cursor data box at the top-right corner. The no. 4 data box only appears if a destination is set.

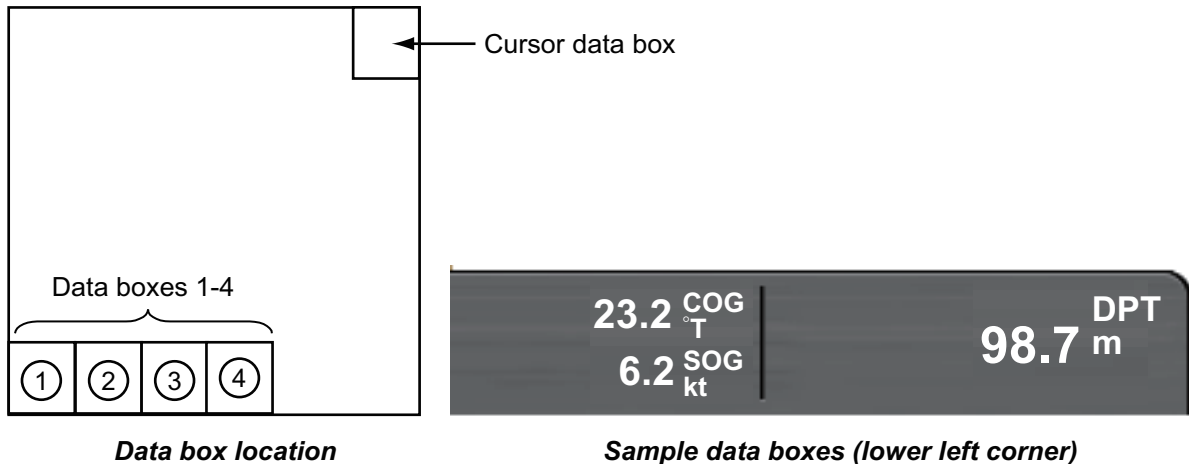

Data box location

Sample data boxes (lower left corner)

To alternately hide and show the boxes, use the **DATA/VOL** key.

You can select the data to display in the boxes on the screen, or from the [Data Box] menu. For additional information, see the section 13.2 "Data Boxes".

To change the contents of a data box:

1. Put the cursor in a data box (the box is blue if correctly selected). Hit the **right-click** button to show the Data Box pop-up menu.
2. Rotate the **RotoKey** to select the data item to show or hide.
3. Push the **RotoKey** to hide or show the item and close the pop-up menu.

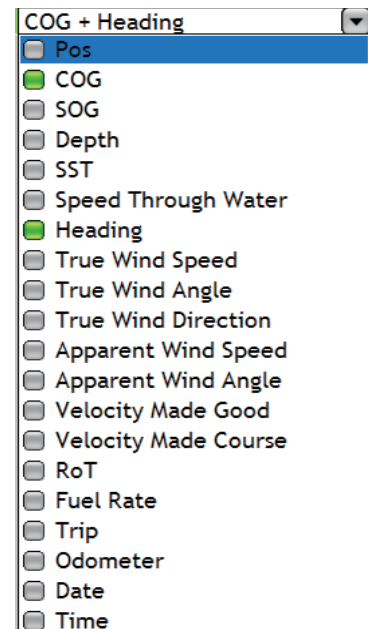

1.15 Menu Introduction

The menu system has a maximum of 15 main menus and related sub menus. The number of menus depends on equipment connected. To show the menu, press the **MENU** key.

How to use the menu

1. Press the **MENU** key to open the menu.
 The last-used menu appears. The Alarm log automatically appears if an alarm condition is broken.
 The icons in the rectangle on the left show all the available menus.

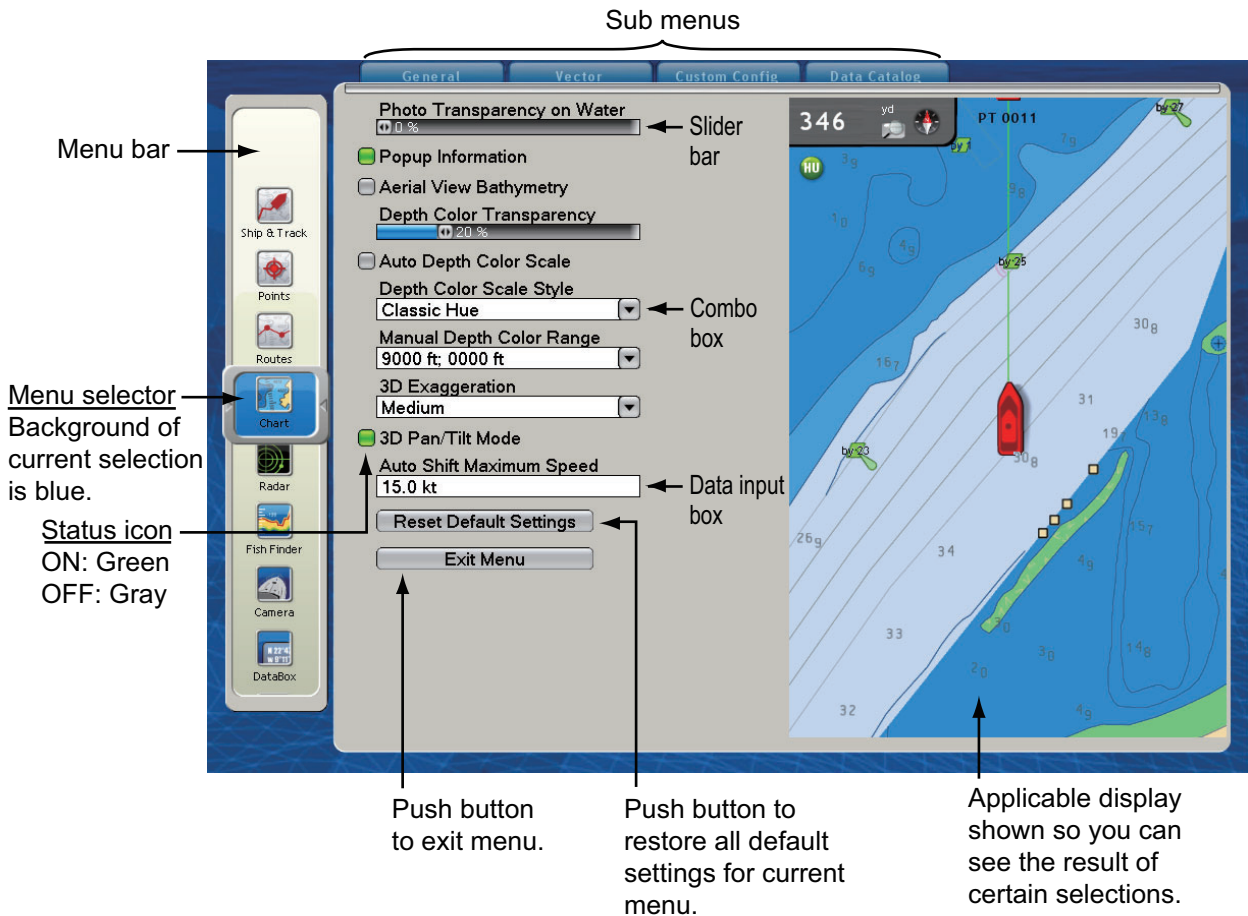

Menu description

Menu icon	Function	Menu icon	Function
 Ship & Track	Select the shape for the boat icon, and control the track of your vessel.	 Targets	Set the ARPA and AIS targets, and manage the DSC message information feature.
 Points	Set points.	 Weather	Set the weather display.
 Routes	Set routes.	 Alarms	Set the alarms.
 Chart	Set the chart plotter display.	 Global	Set the items common to all modes, for example, key beep and the size of the font.
 Radar	Set the radar display.	 Files	File operations which you use a SD card.
 Fish Finder	Set the fish finder display.	 System	System-wide settings like menu language.
 Camera	Set the camera display.	 My NavNet	Set items like the RotoKey and the boat icon.
 DataBox	Set the data boxes.		

2. Rotate the **RotoKey** to select a menu with the menu selector at the left of the screen. Rotate the **RotoKey** to the right to move the menu bar toward the bottom. Rotate the **RotoKey** to the left to move the menu bar toward the top. The back-

1. SYSTEM INTRODUCTION

ground color of the selector is blue, which indicates the menu is selected, but not active.

3. Do one of the following according to menu type:
 - **Single sub menu**, push the **RotoKey** to start the menu operation.
 - **More than one sub menu**, push the **RotoKey**. Rotate the **RotoKey** to select a sub menu then push the key to validate selection. Rotate the key right for selection in the left-to-right direction. Rotate the key left for selection in the opposite direction. The active tab is larger than other tabs.

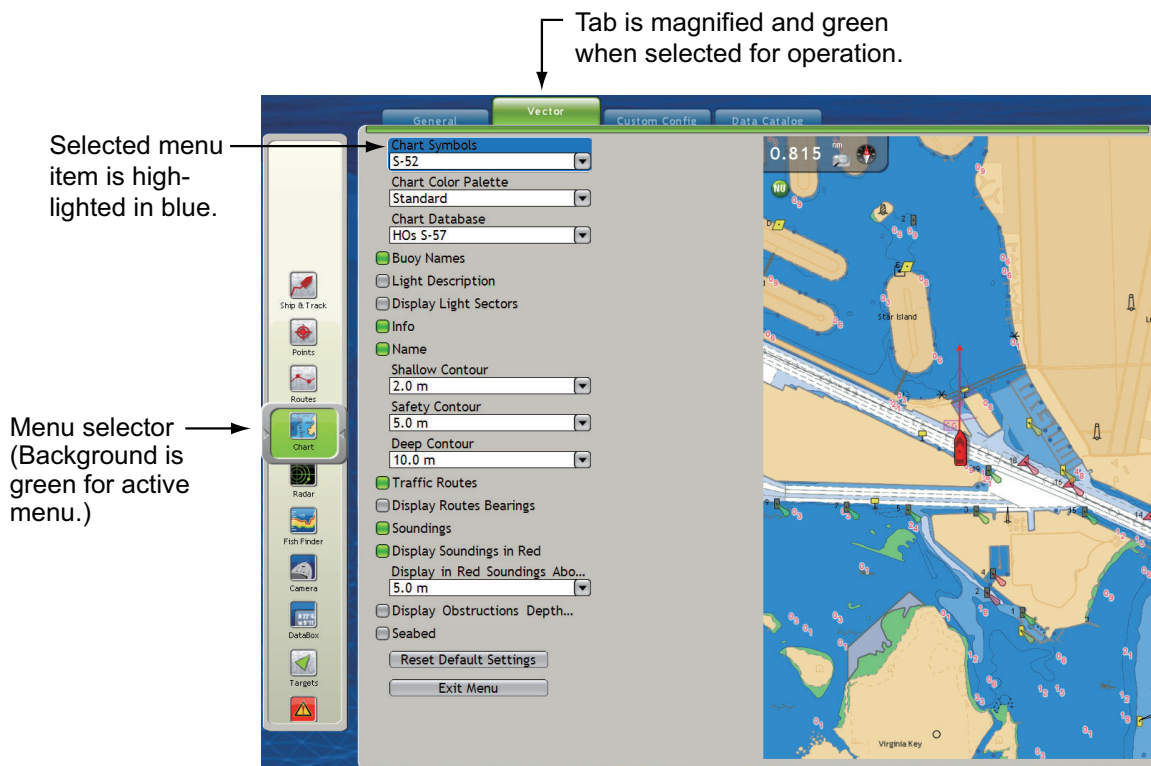

After you push the **RotoKey** to validate the menu selection, the following occurs:

- The tab selected, the bar below the tabs and the background for the menu selector change from blue to green. This occurrence indicates that you can operate the menu selected.
- The top menu item is blue.

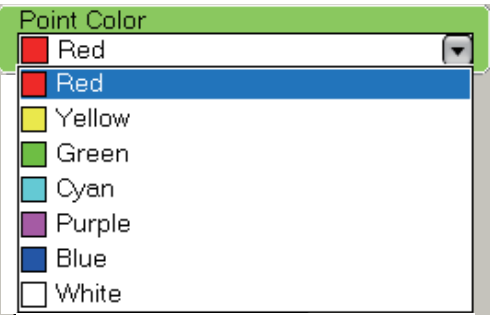

4. Rotate the **RotoKey** to select a menu item then push the key to validate selection. Do one of the following according to the type of menu item selected.

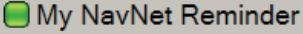
Menu item type	Procedure
<p>Combo box</p> 	<p>Rotate the RotoKey to select an option then push the key to save the setting and close the box. When you turn the key to the right the cursor moves toward the bottom.</p>

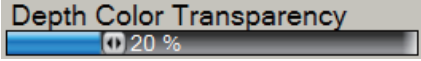
Menu item type	Procedure
Status icon Status icon → 	Items which you can activate or deactivate have a status icon. Push the RotoKey to show the icon in green to activate the item, or gray to deactivate.
Alphanumeric data input box 	Rotate the RotoKey to select alphanumeric character (A-Z, 0-9) then push the key to validate selection. Rotate the key right for forward alphanumeric order. Rotate the key left for reverse alphanumeric order. To set the cursor in a specific location, use ◀ or ▶ on the CursorPad.
Slider bar 	Rotate the RotoKey to set level then push the key to validate the setting.

- To select a different sub menu or a different menu, rotate the **RotoKey** to the left to return control to the menu selector. (You can also return the control to the menu selector when you press the **CANCEL** key continuously.)
- To close the menu, press the **MENU** key, or use the **RotoKey** to click the [Exit Menu] button at the bottom of the menu.

1.16 Language

The default interface language is American English. You can select a language to use as follows:

1. Press the **MENU** key to open the menu.
2. Select the [System-General] menu.
3. Use the **RotoKey** to select [Language].
4. Use the **RotoKey** to select your language.
5. Push the **RotoKey**. You are asked to make sure you are ready restart. Use the **RotoKey** to select Yes.

1.17 Boat Icon

The boat icon marks current position, and the default shape is "simplified icon." If your vessel is different, you can change the shape of the boat icon to match your vessel.



Simplified icon (default boat icon)

1. Press the **MENU** key to open the menu.
2. Open the [My NavNet-General] menu.
3. Use the **RotoKey** to select [Boat Icon].

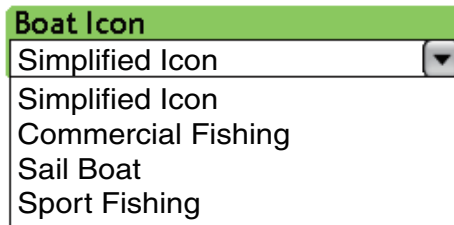

4. Use the **RotoKey** to select the boat icon which best matches your vessel.
5. Press the **MENU** key to close the menu.

1.18 Man Overboard (MOB)

Use the MOB function if a person or object falls overboard. You need either position data from a navigation device, or heading and speed data to calculate position by dead reckoning. You activate the MOB from the chart plotter display and MOB position is marked on both the chart plotter and radar displays.

To mark the MOB position, long-push the **SAVE/MOB** key on the chart plotter display. Then, the following occurs:

- The MOB mark is put on the chart plotter and radar, at the position when the **SAVE/MOB** key is pressed.



MOB mark on
radar display



MOB

MOB mark on
chart plotter display

- The chart scale is automatically set to 0.250 nm.
- The distance and the time to go to the MOB position appear in the far right-hand side data box. (Chart plotter and radar displays only).

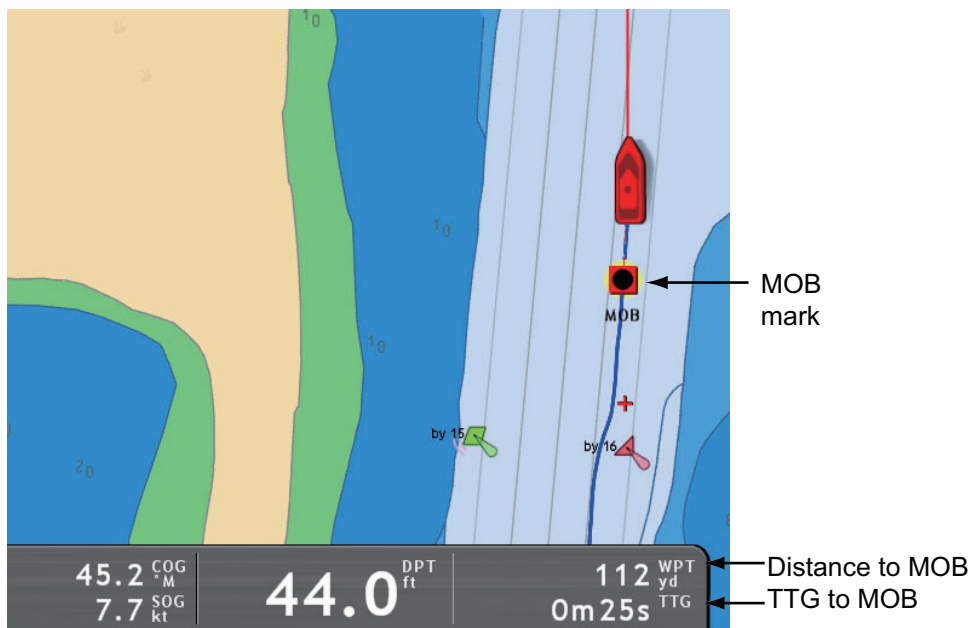

- A red dashed line runs between the MOB position and your vessel on the chart plotter and radar displays. This line is the course to take to go to the MOB position.

MOB information

There are two types of MOB information, simple and detailed. Simple information includes point name (MOB), and range and bearing to the MOB position. Detailed information includes simple information plus the information shown below.

- Comment (default comment is “time of MOB”)
- Depth at MOB position (requires depth sensor)
- Water temperature at MOB position (requires temperature sensor)
- Group name (if any)
- Avoidance circle radius

To get simple information, put the cursor on the MOB mark on the chart plotter display. For detailed information, put the cursor on the MOB mark and hit the **left-click** button.

Name	MOB
Range	244 yd
Bearing	229.1 °M

Simple MOB information

Object Detail	
Name	MOB
Comment	Oct0307 015918 PM
Range	244 yd
Bearing	229.1°M
Depth	0.0 ft
Temp	32.00 °F
Group	
Avoidance Circle Area	0 yd

Detailed MOB information

How to erase a MOB mark

You can erase a MOB mark on the chart plotter display, or at the [Points] list in the [Points] menu.

Not active MOB mark: Put the cursor on the MOB mark and press the **right-click** button to show the Points pop-up menu. Use the **RotoKey** to select [Delete].

Active MOB mark: Before you can erase an active MOB mark, you must cancel navigation. Put the cursor on the MOB mark and press the **right-click** button to show the Points pop-up menu. Rotate the **RotoKey** to select [Cancel Route] then push the **RotoKey**. Select again the MOB mark, show the Points pop-up menu, and use the **RotoKey** to select [Delete].

Move
Go To
Edit
Rename
Delete

Points popup menu
(No route active)

Move
Cancel Route
Restart
Extend Route
Edit
Rename

Points popup menu
(Route active)

1.19 Facsimile Receiver FAX-30

The FURUNO Facsimile Receiver FAX-30 installs in the NavNet network and can be controlled from a NavNet display. Below are the steps to start fax operation.

1. At installation of this equipment, connect the FAX-30 to the NavNet and check that the equipment identifies the FAX-30, through the Installation Wizard.
2. Select the "full screen" FAX display. For the procedure, refer to the section 13.3 "How to Set the Display Selection Window". The fax display is available only in the full-screen display.



3. To operate the FAX-30, use the **DISP** key to select the fax display icon to show the fax display. A sample display is shown below. Refer to the Operator's Manual of the FAX-30 for operation information.

Use the CursorPad or a PC mouse to operate the fax screens.

The FAX-30 display can be accessed only by one NavNet display. When another NavNet display accesses the FAX-30, control of the FAX-30 is given to that display after the picture is stopped completely. This sequence takes approximately one minute.

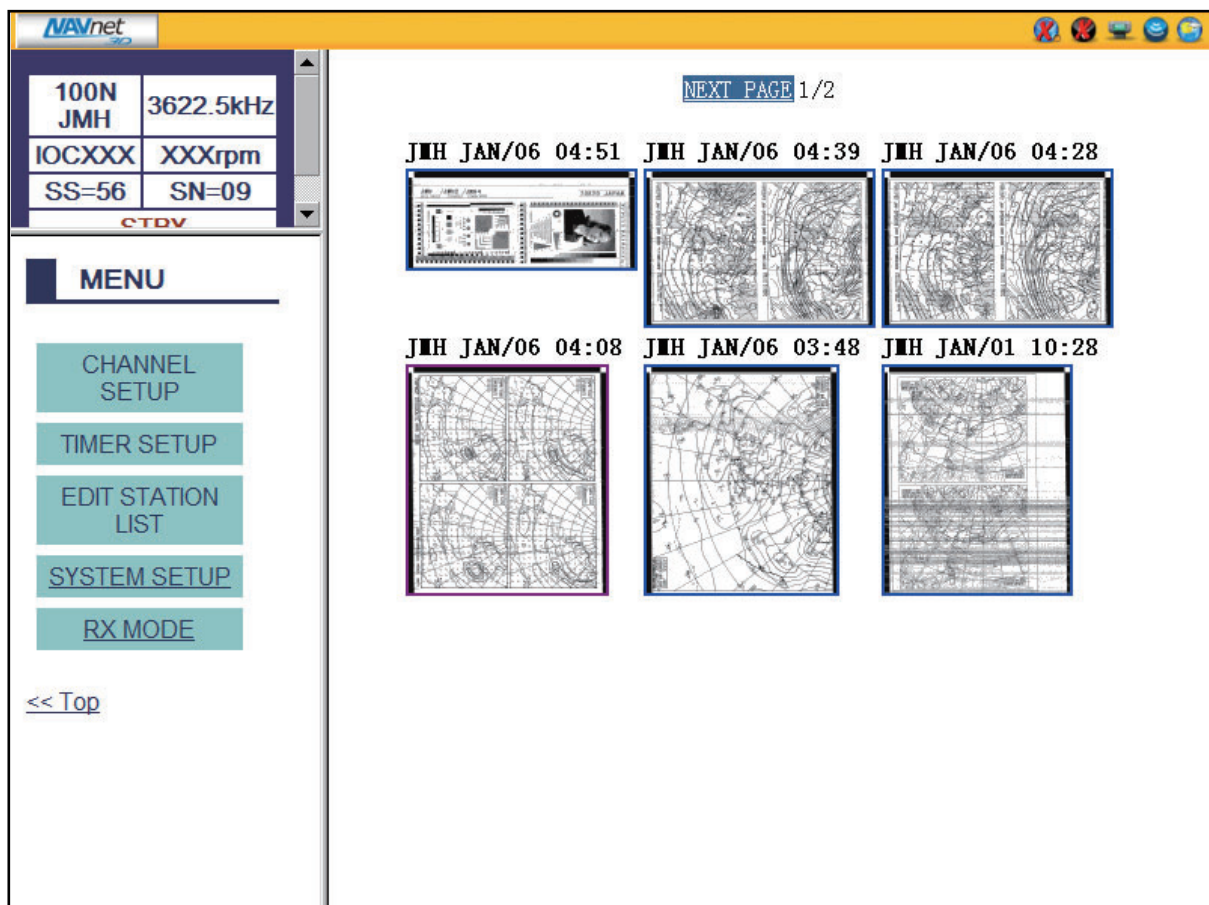

1.20 AIS Transponder FA-30, FA-50

The FURUNO AIS Transponder FA-30 (FA-50) installs in the NavNet network and can be controlled from a NavNet display. To access the main menu of the transponder, do the following:

1. Open the main menu and select the [System] menu.
2. Open the [Other Sensors] sub menu.
3. Use the **RotoKey** to click the FA-30 (FA-50) button to show the main menu of the transponder.

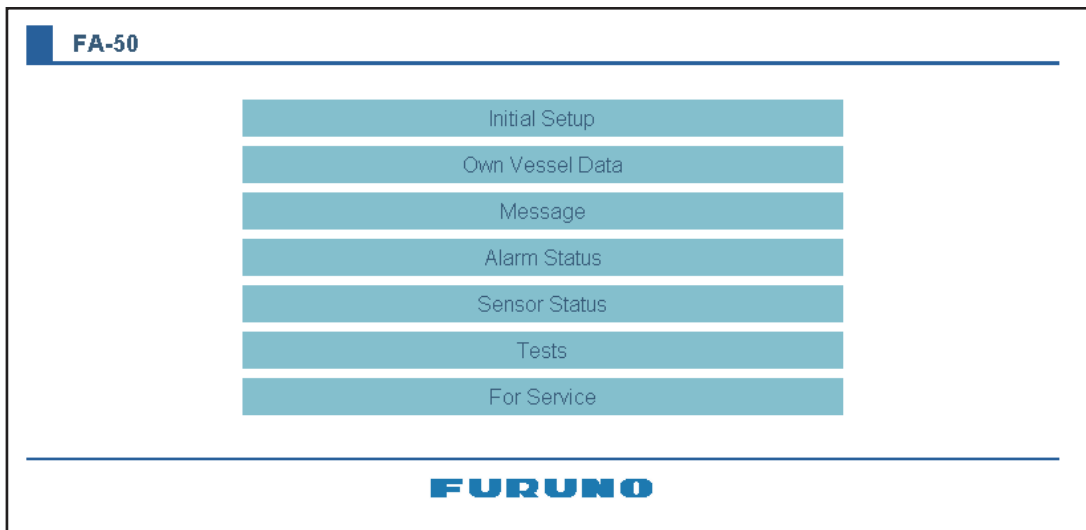
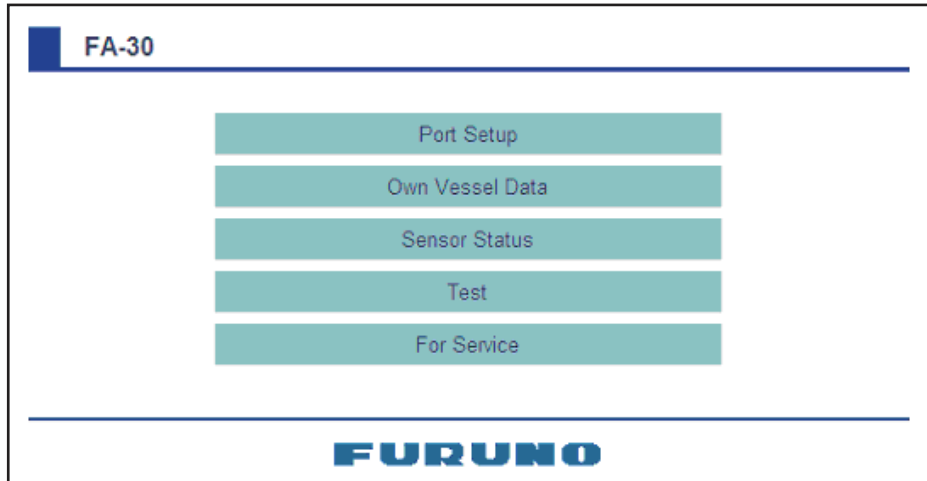

4. Use the CursorPad to operate the menu, referring to the operator's manual of the AIS transponder.

1.21 DSC Message Information

The DSC (Digital Selective Calling) message information feature provides, on the chart plotter and radar displays, the MMSI no. and position* of the ships that have transmitted a DSC message to you. A hexagon-shaped marker marks a ship's position. The marker is color-coded according to the type of DSC message sent, red for distress and dark-blue for non-distress.

* Position at the time of message transmission. Position information is not updated.

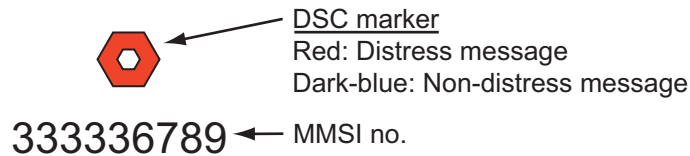

This feature requires connection of a DSC capable radiotelephone that outputs the DSC sentence in NMEA 0183 format.

1.21.1 How to Show, Hide DSC Message Information

On the chart plotter or radar display, long-push the **RotoKey**. Rotate the **RotoKey** to select [Target] then [DSC]. Push the **RotoKey** to show or hide the DSC message information.

When you receive a DSC message, the appropriate DSC marker and the MMSI no. of the transmitting ship appear on the chart plotter and radar displays.

1.21.2 How to Find DSC Information

Put the cursor on a DSC marker to find the position and MMSI no. of the ship that transmitted a DSC message. For MMSI no., position, and type of DSC message, push the **left-click** button.



Simple DSC information

Object Detail	
MMSI	333336789
Position	34° 50.0782' N; 135° 20.7833' W
Type	Distress

Detailed DSC information

1.21.3 Operations Available with the DSC Marker

With the DSC marker pop-up you can

- Delete the selected DSC marker (and its data from the DSC list).
 - Set the position of the DSC marker as your destination. (See section 4.11.)
 - Save the position of the DSC marker as a point. (See section 4.2.)
1. Put the cursor on a DSC marker then push the **right-click** button to show the DSC marker pop-up.

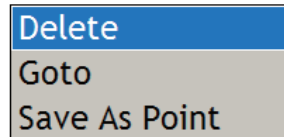

2. Rotate the **RotoKey** to select desired item then push the **RotoKey**.
3. For [Goto] and [Save as Point], refer to the appropriate section indicated above.

1.21.4 The DSC List

The DSC list, found in the [Targets] menu, lets you list the MMSI no. of 10 ships from which you have received a DSC message. To help you identify a ship quickly on the chart plotter and radar displays, you can replace the MMSI no. indication with the name of your choice; for example, ship's name.

To show the DSC list, open the [Targets] menu and select the [DSC] tab.

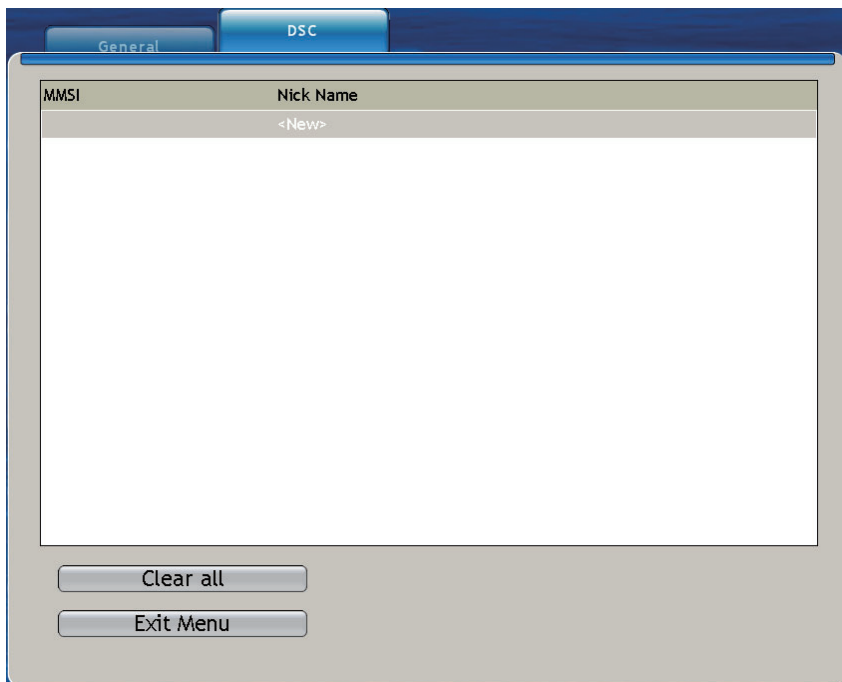

How to add an MMSI no. to the DSC list

1. Show the DSC list then push the **RotoKey** twice to select [<New>].
2. Push the **RotoKey** to show the DSC list pop-up.

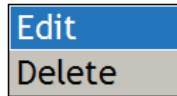

3. The cursor is selecting [Edit]; push the **RotoKey** to show the MMSI and Nick Name input window.

4. The cursor is selecting [MMSI]; push the **RotoKey**.
5. Use the **RotoKey** to enter MMSI no. (See the instructions on page 1-19 for how to enter data.)
6. Use the **RotoKey** to select [Nick Name] then push the **RotoKey**.
7. Use the **RotoKey** to enter a nickname. Up to 20 alphanumeric characters can be used.
8. Use the **RotoKey** to select the **OK** button then push the **RotoKey**.
9. Press the **MENU** key to close the menu.

How to edit an MMSI no. on the DSC list

Show the DSC list then push the **RotoKey** twice. Rotate the **RotoKey** to select the MMSI no. Continue from step 2 in "How to add an MMSI no. to the DSC list".

How to delete an MMSI no.

The DSC list stores 10 MMSI nos. When the list becomes full, no new MMSI no. can be entered. To enter a new MMSI no., delete unnecessary MMSI nos. as follows:

1. Show the DSC list.
2. Use the **RotoKey** to select the MMSI no. to delete then push the **RotoKey**.
3. Use the **RotoKey** to select [Delete] then push the **RotoKey**.
4. Press the **MENU** key to close the menu.

The MMSI no. is deleted from the DSC list and the DSC marker and MMSI no. (or nickname) are deleted from the chart plotter and radar displays.

How to delete all MMSI nos.

Use the **RotoKey** to "click" the **Clear all** button on the DSC list. These MMSI nos. and DSC markers are deleted:

- MMSI nos. on the DSC list
- MMSI nos. (or nicknames) and DSC markers on the chart plotter and radar displays

1. SYSTEM INTRODUCTION

This page is intentionally left blank.

2. CHART PLOTTER

This chapter shows you how to do the following:

- Use and prepare the chart plotter
- Set chart plotter related alarms
- Control the track

2.1 Charts

2.1.1 Chart Description

A world map in raster chart format is included in your unit. A vector chart for the US coastline (Alaska and Hawaii included) is provided also. To use this chart plotter as a navigational aid, have electronic charts (stored in the hard disk) for the area you navigate. Contact your dealer about charts for your area. To control the charts stored in your system, see the section 13.7 "How to Control Charts".

Raster charts are digitized scans of NOAA paper charts. Raster charts have information like notes, source diagrams, tidal diamonds, horizontal and vertical datum, etc.

Vector charts are digital files that contain marine features and information created for marine navigation. These charts are made according to the International Hydrographic Organization (IHO).

Fishing charts are vector charts that show only detailed depth contours. These are available for US waters.

See the next two pages for sample charts.

2.1.2 How to Select a Chart Type

Push the **RotoKey**, rotate the key to select [Chart] followed by [Raster], [Vector] or [Fishing] then push the key.

2. CHART PLOTTER

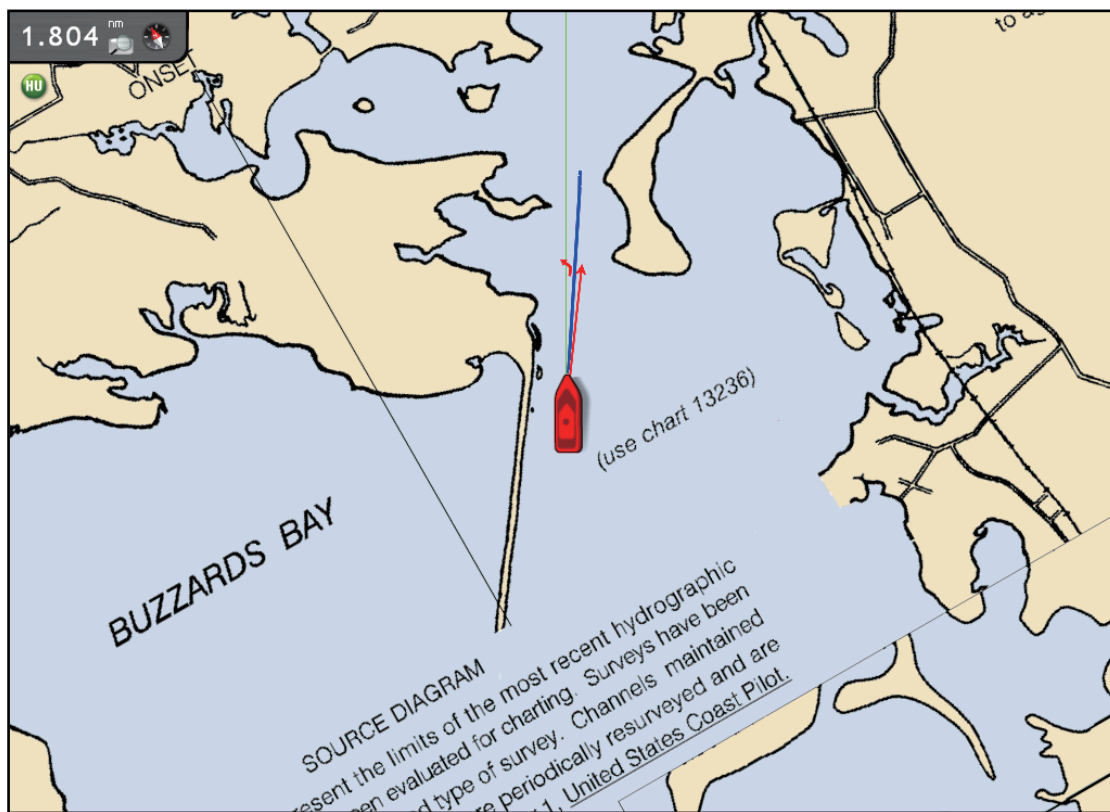

Raster chart

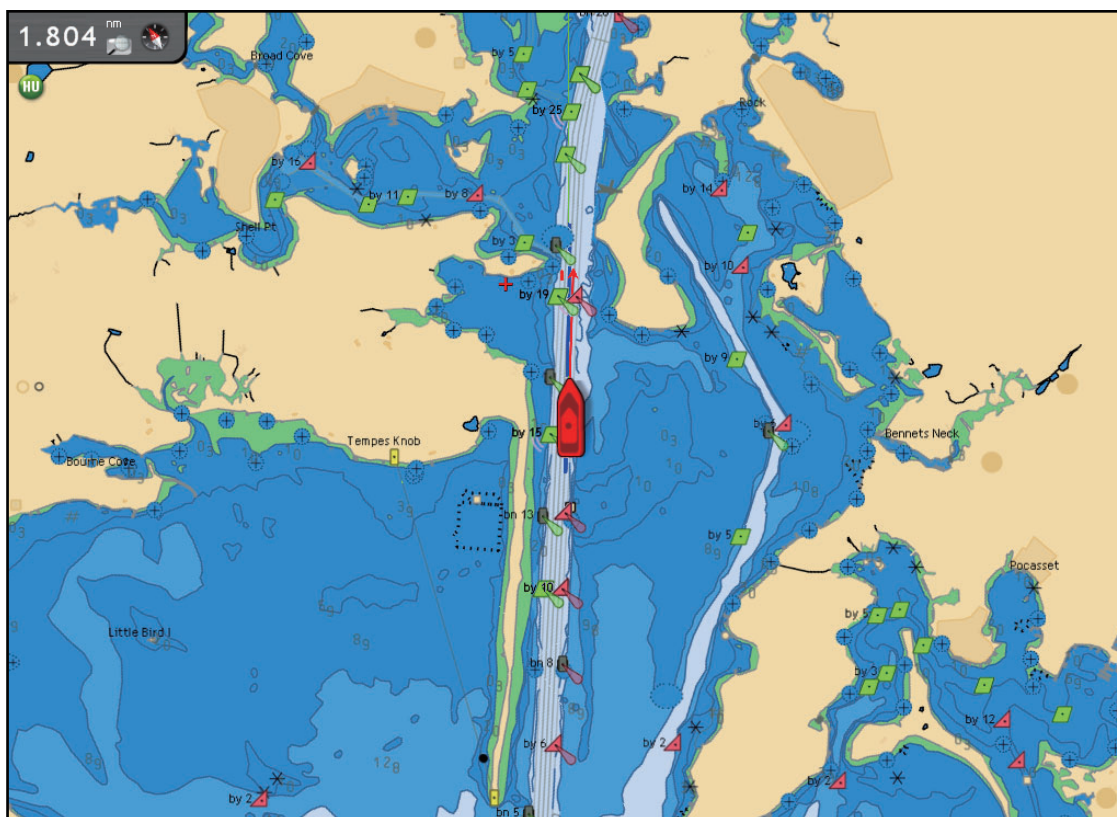

Vector chart

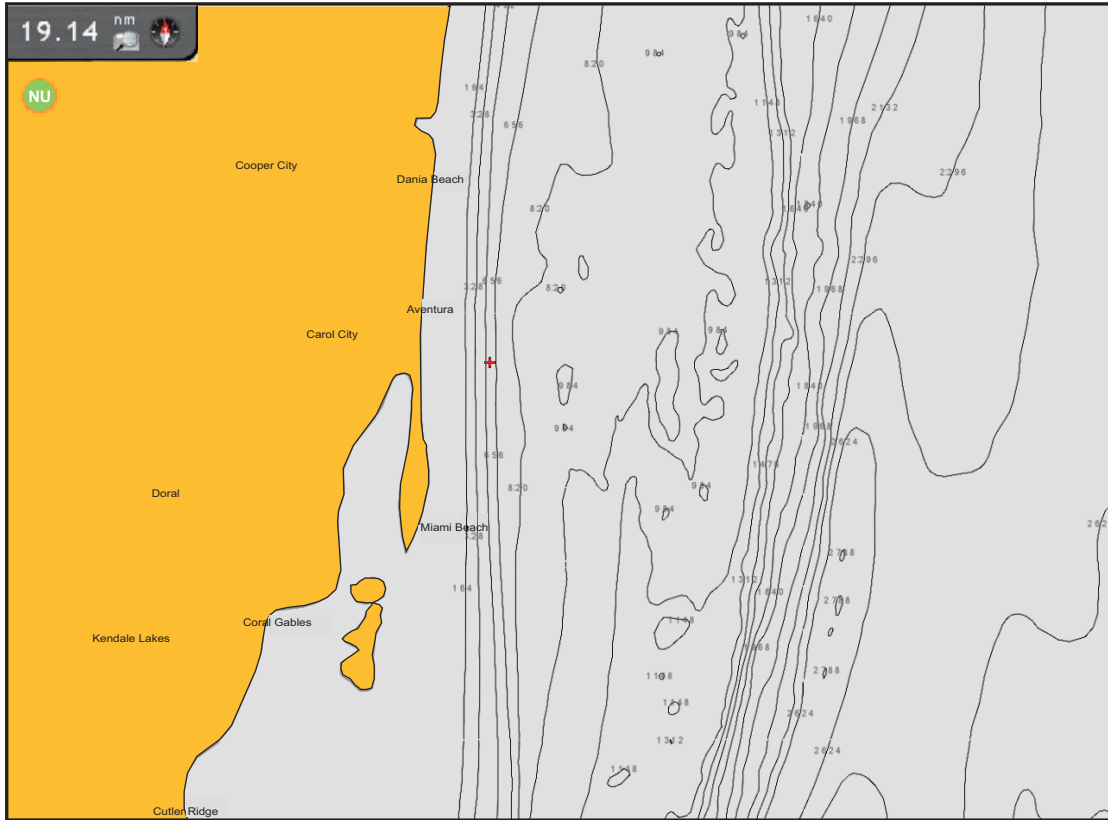

Fishing chart

2.2 Chart Scale

You can change the chart scale to change the amount of information shown, or zoom in or out at the location you select. The selected chart scale appears at the top left-hand position on the screen. In the full screen display, the value shown is 1/2 the distance from the top of the screen to the bottom of the screen.

There are two methods to change the chart scale, the **RANGE** key, and the cursor with the **RotoKey**.

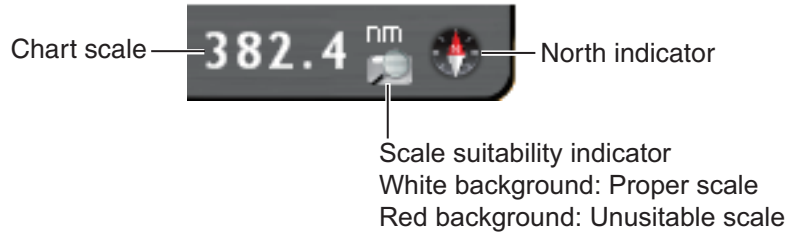

Method 1: RANGE key

Use the **RANGE** key to select a chart scale. When you operate a **RANGE** key, the chart scale changes to the next available setting. Push **RANGE IN** to decrease chart distance, then push **RANGE OUT** to increase the chart distance. The current chart scale is shown in the chart scale indication at the top-left corner. The scale suitability indicator helps you select an acceptable chart scale. The background of the indicator is white if the scale is acceptable, and red if the scale is unacceptable.

Method 2: CursorPad and RotoKey

This method lets you select ranges between 0.0625 and 120 nm. Use the CursorPad to put the cursor on the chart scale indication. Press the **right-click** button to show the Range pop-up menu, shown below. Rotate the **RotoKey** to select a range then push the key to validate your selection.

0.0625 nm
0.125 nm
0.25 nm
0.5 nm
0.75 nm
1 nm
1.5 nm
2 nm
3 nm
4 nm
6 nm
8 nm
12 nm
16 nm
24 nm
32 nm
36 nm
48 nm
64 nm
72 nm
96 nm
120 nm

2.3 Orientation Mode

The chart can be shown in head-up, course-up or north-up orientation. To select an orientation mode, use the **RotoKey** to select the [Head Up], [North Up] or [Course Up] soft control. Another method is to put the cursor on the orientation mode icon at the top-left position then push the **left-click** button.

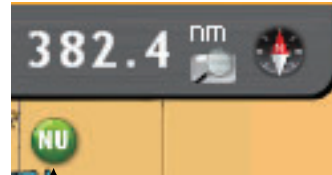

Orientation mode icon

Description of orientation modes

Head-up: Displays the chart with the current compass heading of your vessel at the top of the screen. The heading data from a compass is required. When the heading changes, the boat icon remains fixed, and the chart picture rotates according to heading.

North-up: North is at the top of the screen. When your heading changes, the boat icon moves according to heading. This mode is for long-range navigation.

Course-up: The chart picture is stabilized, and shown with your current course (over ground) at the top of the screen. The boat icon moves with the heading. If you select a new course, the picture resets to display the new course at the top of the screen.

2.4 How to Move the Chart

Move the chart in the following conditions.

- Your vessel is not in the current area
- Take a look at another area
- Enter a waypoint at another location

Do the following to move the chart:

- Change the chart scale with zoom in or zoom out at cursor position.
- Use the ScrollingPad to pan the chart.
- Return your vessel to the center of the screen. Use the **SHIP/3D** button to return manually, or use the [Auto Shift] soft control to return automatically.
- Activate the 3D display. Long-push the **SHIP/3D** button to get a simple aerial view 3D display. Use the RotoKey to get an aerial view or underwater view 3D display.

2.5 The Boat Icon

The boat icon appears at current position. The default shape is “simplified icon”. Other shapes are available, from the menu, like yacht and sailboat. The boat icon has the functions indicated below also.

- The **Heading line** is a straight line that runs from your position and this line shows the current heading.
- The **COG/SOG predictor** is a vector line that runs from the boat icon. This predictor shows estimated course and speed of your vessel. The top of the predictor is the estimated position of your vessel at the end of the selected predictor time (set on the menu). You can increase the length of the predictor to find the estimated position of your vessel in the future on the current course and speed.
- The **Direction of turn indicator** points in the direction in which your vessel is now turning.
- The **Track** plots the movement of your vessel.

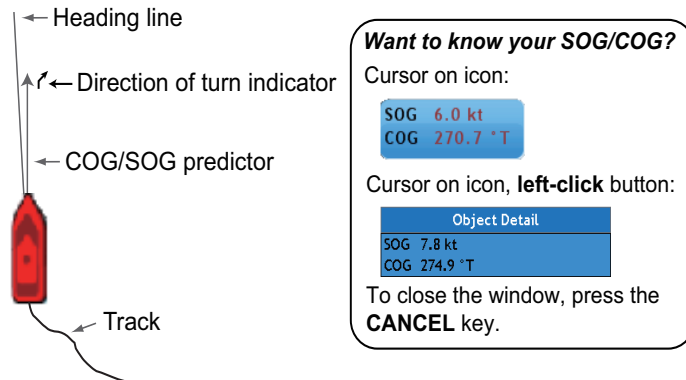

Orientation of boat icon

The orientation of the boat icon can be selected to COG or heading. When the heading data becomes lost, the orientation is automatically set to COG.

To select the orientation, do as follows:

1. Press the **MENU** key to open the menu.
2. Use the **RotoKey** to select the [Ship & Track] menu, followed by the [General] menu.
3. Use the **RotoKey** to select [Boat Icon Orientation].

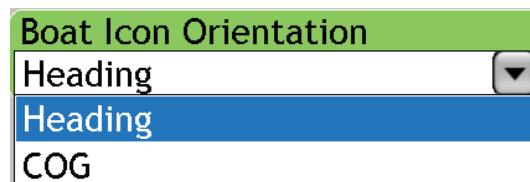

4. Select [Heading] or [COG] then push the **RotoKey**.
5. Press the **MENU** key to close the menu.

Boat icon pop-up menu

The Boat Icon pop-up menu controls the COG/SOG predictor, heading line and track. To display this pop-up, put the cursor on the boat icon then push the **right-click** button.

Boat icon pop-up menu

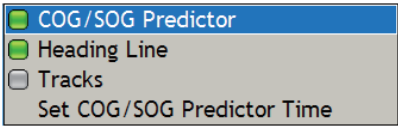
Turn on or off as appropriate. 

To set COG/SOG predictor time, select Set COG/SOG Predictor Time and hit **left-click** button to show the Ship & Track menu.

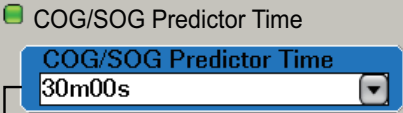

Select COG/SOG Predictor Time and push RotoKey.

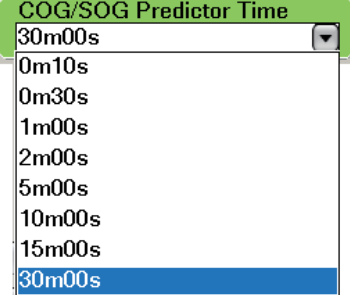

Rotate RotoKey to select a time.
Push RotoKey to confirm setting.
The greater the time the longer the COG/SOG predictor.

2.6 How to Find the Range and Bearing to a Location

The "ruler" feature measures the range and bearing between any two points on your chart. Range and bearing between the two points are digitally indicated on the screen.

1. Use the CursorPad to put the cursor on the start point.
2. Long-push the **RotoKey**.
3. Use the **RotoKey** to select [Ruler].
4. Use the CursorPad to move the cursor to the 2nd point. A dashed line runs between the start point and the 2nd point. The range and bearing to the cursor position are shown next to the cursor.
5. Push the **RotoKey** to erase the ruler and the indication.

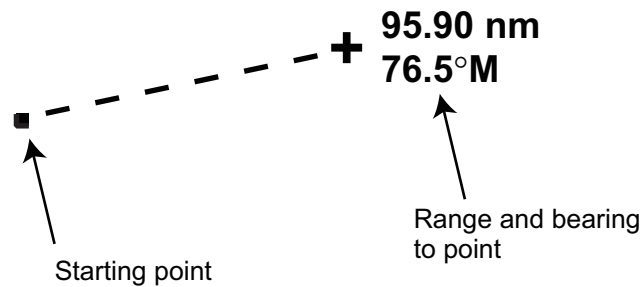

2.7 Chart Object Information

Vector charts show many objects, like buoys and lighthouses, for which you can find information. Port, tide and current information are available if the chart contains this information.

Put the cursor on any chart object to find object type. For additional information, push the **left-click** button.

Object Detail	
Buoy, lateral	
Buoy shape	conical (nun, ogival)
Category of	starboard-hand lateral mark
Colour	red
Object name	Phinneys Harbor Buoy 14
Scale minimum	1:150000
Source date	Mar/07/98
Source indic	US,US,graph,chart 13236
Status	permanent

Buoy, lateral Phinneys Harbor Buoy 6

Simple chart object information *Detailed chart object information*

2.8 Multiple Chart Plotter Displays

A maximum of two chart plotter displays can be shown on one screen. The multiple chart plotter display lets you see the conditions around your vessel on both short and long ranges. Also, you can see how your vessel moves toward your destination from more than one angle. For example, you can show one display in 2D and another in 3D.

The following features can be adjusted individually.

- AIS
- ARPA
- Chart scale
- Chart orientation
- Chart type
- Countdown timer
- Create routes
- Overlays (sat photo, depth shading, tide icon, tidal current, weather)
- Scroll the chart
- 2D and 3D (The 3D displays are adjusted together, but different orientations are possible.)

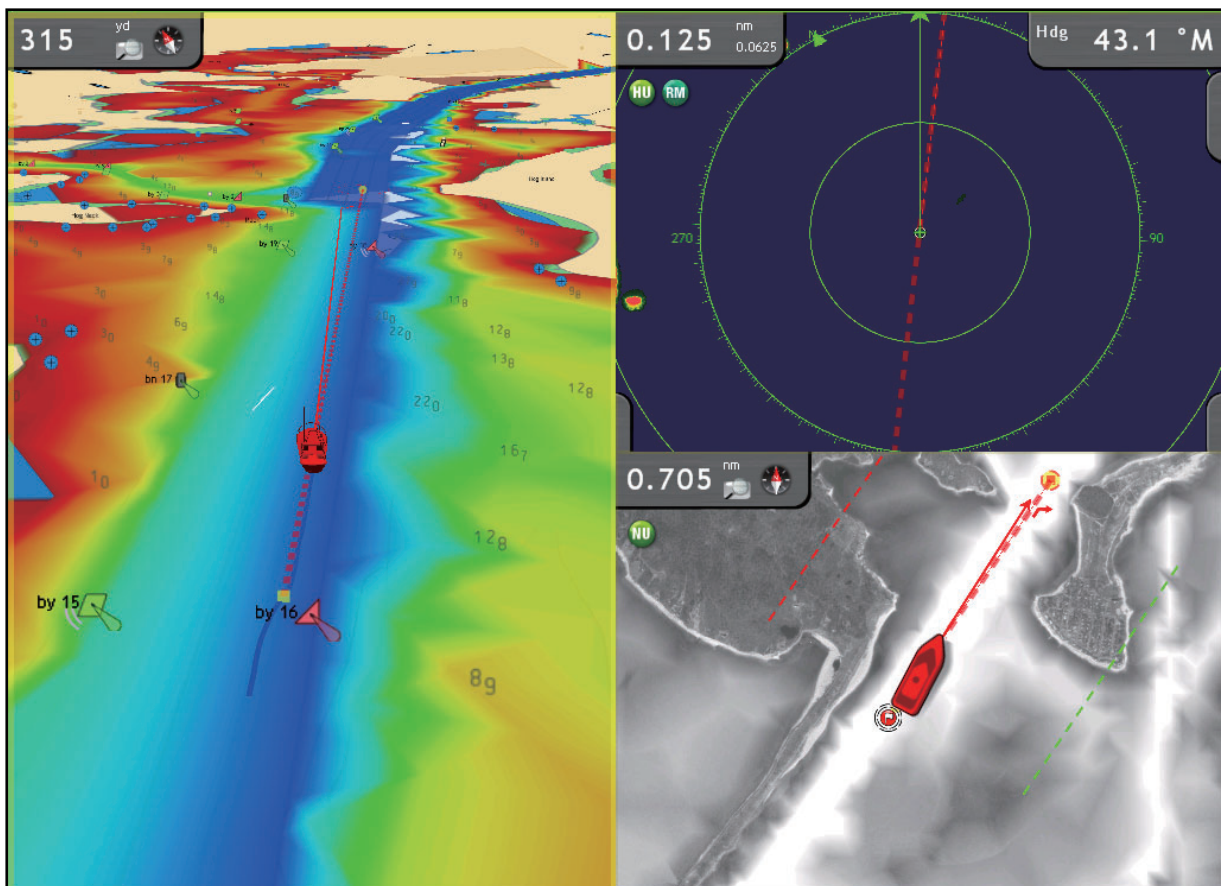

Chart plotter display 1

Chart type: Vector
 Chart scale: 315 yd
 Orientation: Head-up
 Perspective: 3D
 Overlay: Depth shading

Chart plotter display 2

Chart type: Raster
 Chart scale: 0.705 nm
 Orientation: North-up
 Perspective: 2D
 Overlay: Satellite photo

2.9 Cartographic Text and Objects on Vector Charts

This section shows you how to show or hide the cartographic objects and text information that appear on vector charts.

2.9.1 Control Visibility of Text and Object Information

The [Chart-Vector] menu controls the visibility of text and object information, for example, buoy names and light description.

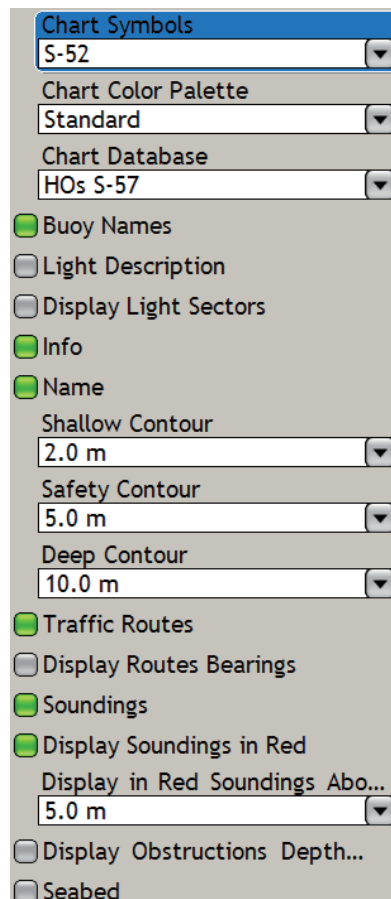

Chart-vector menu items

Chart Symbols: Select the chart symbol type. [S-52] are the official IMO symbols (also referred to as simplified symbols) library for ECDIS. [International] symbols are the copy of paper chart symbols of IALA symbols library (US symbols library).

Chart Color Palette: Set the chart color pattern. [Standard] is the NAVNet 3D original color palette, [S-52] complies with the official S-52 charts, and [Sunlight] provides a high contrast palette.

Chart Database: Select the chart database to use among [HOs S-57], [Jeppesen], and [Navionics].

Buoy Names: Show or hide the buoy names.

Light Description: Show or hide the light descriptions.

Display Light Sectors: Show or hide lights sectors for fixed beacons.

Info: Show or hide text information.

Name: Show or hide geographic names.

Shallow Contour: Show shallow depth contours in dark blue.

Safety Contour: Show safety depth contours in medium blue.

Deep Contour: Show deep depth contours in light blue. Depths greater than 1800 feet are shown in white.

Traffic Routes: Show or hide traffic routes.

Display Routes Bearings: Show or hide route bearings.

Soundings: Show or hide depth soundings.

Display Soundings in Red: Spot soundings whose depths are lower than the value set here are shown in red.

Display Obstructions Depth Below Safety: Show or hide obstruction depths under the safety depths.

Seabed: Show or hide seabed composition indication, for example, mud, sand, rock.

2.9.2 Control Visibility of Cartographic Objects

The [Chart-Custom Config] menu controls the visibility of cartographic objects, for example, lights, fog signals, etc.

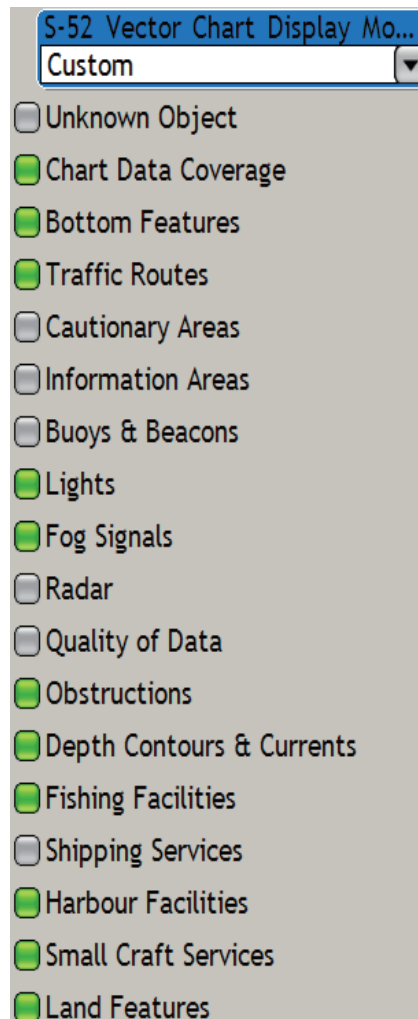

Chart-config menu description

S-52 Vector Chart Display Mode: Set the level of information to show on the chart. The selections are [Basic], [Standard], [Other], [Fishing], [Custom], and [Default]. The chart features are turned on or off according to setting.

Unknown Object: Unknown objects that appear on the chart.

Chart Data Coverage: Geographic names and geographic objects.

Bottom Features: Improved seabed presentation.

Traffic Routes: Marine traffic routes.

Cautionary Areas: Cautionary areas that appear on the chart.

Information Areas: Information areas that appear the chart.

Buoys & Beacons: Buoys and beacons.

Lights: The sector of light that a fixed beacon shines.

Fog Signals: A structure that sends a fog signal.

Radar: Radar buoy

Quality of Data: Quality of data indicator.

Obstructions: Obstructions (wrecks, etc.)

Depth Contours & Currents: Lines that indicate depth contours and currents.

Fishing Facilities: Show location of fishing facilities.

Shipping Facilities: Show location of shipping facilities.

Harbour Facilities: Show location of harbour facilities.

Small Craft Services: Services for small craft.

Land Features: Cartographic features that are shown on land.

2.10 Alarms

This section describes the alarms available with the chart plotter:

- XTE alarm
- Anchor watch alarm
- Proximity alarm
- Depth alarm
- Sea surface temperature alarm
- Sea surface temperature shear
- Speed alarm
- Trip log alarm
- Countdown timer
- Alarm clock

2.10.1 XTE Alarm

The XTE alarm tells you when your vessel is not on course by more than the set value. When the XTE alarm is active, two dashed lines mark the XTE alarm boundaries, red for starboard, green for port.

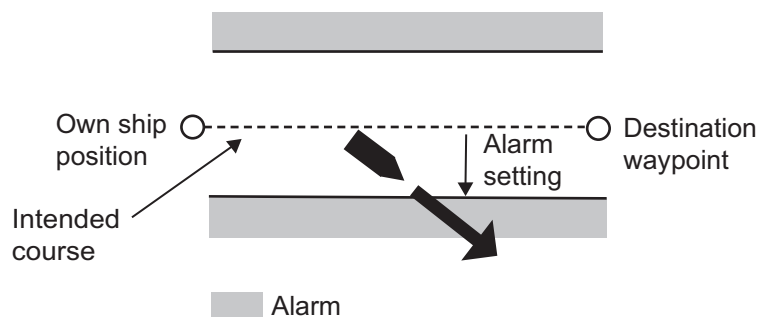

2.10.2 Anchor Watch Alarm

The anchor watch alarm tells you that your vessel has moved a distance greater than the set value when the vessel must not be moving.

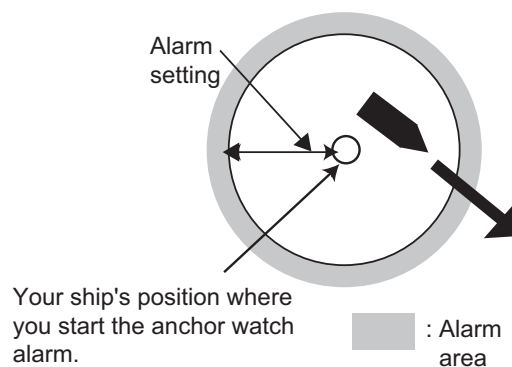

2.10.3 Proximity Alarm

The proximity alarm tells you when your vessel is near a point for which an avoidance circle, set on the [Points] list, is active. When your vessel is within the set value, audio and visual alarms are released.

2.10.4 Depth Alarm

The depth alarm tells you when the depth to the bottom is over or under the value you set. Requires depth data.

2.10.5 SST Alarm

The SST (Sea Surface Temperature) alarms tells you when the sea surface temperature is over, under, within range, or out of range of the temperature you set. “[Shear]” tells you when the temperature goes higher or lower than the set value within one minute.

Set the [Over] and [Under] alarm value with “[SST Alarm Value]”, and shear with “[Shear]”. For [Within Range] and [Out of Range], set the alarm value with [SST Alarm Range].

Requires temperature sensor.

2.10.6 Speed

The speed alarm tells you when the speed of your vessel is within range, out of range, over or under the set value. Set the value at [Speed Alarm Value]. Requires a GPS navigator or speed sensor.

2.10.7 Trip Log Alarm

The trip log alarm tells you when your vessel has moved some distance. Requires a GPS navigator.

2.10.8 Countdown Timer

The countdown timer measures the remaining time from a set time, and is available on the chart plotter display. Set the alarm time on the [Alarm] menu. Start and stop the timer from the chart plotter display. Long-push the **RotoKey** to select [Countdown] then push the **RotoKey** to start or stop the timer. The timer appears at the center of the plotter chart display. When the set time is reached, some beeps sound and the countdown indication is erased from the screen.



4m51s

2.10.9 Alarm Clock

The alarm clock operates like an standard alarm clock, releasing audio and visual alarms when the set time comes.

2.10.10 How to Set an Alarm

1. Press the **MENU** key to open the menu.
2. Open the [Alarms-General] menu.

The screenshot shows the 'Alarms-General' menu with the following settings:

- Alarm: Off
- Speaker Alarm Output
- Speed-Based Output
 - Speed-Based Output Value: 10.0 kt
- External Alarm Input: MOB
- XTE Alarm
 - XTE Alarm Value: 100 yd
- Anchor Watch Alarm
 - Anchor Watch Alarm Value: 100 yd
- Proximity Alarm
 - Depth Alarm: Off
 - Depth Alarm Value: 030 ft
 - SST Alarm: Off
 - SST Alarm Value or Shear: +009.00 °F
 - SST Alarm Range: +059.00 °F +068.00 °F
 - Speed Alarm: Off
 - Speed Alarm Value: 010.0 kt
 - Speed Alarm Range: 010.0 kt 015.0 kt
- Trip Log Alarm

Additional settings on the right side:

- Trip Log Alarm Value: 001 nm
- Countdown Timer Value: 06m
- Alarm Clock
 - Alarm Clock Time: 15:03
 - Alarm Clock Date: 01/Jan/03
- Sirius Marine WatchBox

Buttons: Reset Default Settings, Exit Menu

3. Use the **RotoKey** to select an alarm item then do one of the following:
 - a) **For the alarms which have a status icon**, push the **RotoKey** to activate or deactivate the alarm. Show the icon in green to activate the alarm, or gray to deactivate the alarm.
 - b) **For the depth, speed and SST alarms**, select the combo box of the item then push the **RotoKey** to show the alarm options. Use the **RotoKey** to select an option.

Depth Alarm dropdown menu options: Off, Over, Under

Speed Alarm dropdown menu options: Off, Within Range, Out Of Range, Over, Under

SST Alarm dropdown menu options: Off, Over, Under, Shear, Within range, Out of range

4. Use the **RotoKey** to select the [Alarm Value] box for the alarm.

2. CHART PLOTTER

5. Use the **RotoKey** to set a value. Rotate the key to select a value then push the key to validate the setting.
6. Press the **MENU** key to close the menu.

2.10.11 Internal/External Alarm

The audio alarm is output from this equipment in the default setting. The alarm can be output from this equipment, from external equipment or from both this equipment and external equipment.

1. Press the **MENU** key to open the menu.
2. Open the [Alarms-General] menu.
3. Use the **RotoKey** to select and set [Alarm] to select how to output alarms.
[Internal]: Output the audio alarm from this equipment.
[External]: Output the audio alarm from external equipment.
[Internal/External]: Output the audio alarm from both this equipment and external equipment.
[Off]: No alarm output.
4. Use the **RotoKey** to select [External Alarm Input]. Select the item to output when you operate the **SAVE/MOB** key.
[OFF]: No output
[Save]*: The point saved with the **SAVE/MOB** key is output.
[MOB]*: The MOB point saved with the **SAVE/MOB** key is output.
* Do not select when [Alarm] is set for [External] or [Internal/External].
5. Press the **MENU** key to close the menu.

2.10.12 Alarm Audio Options

When an alarm setting is broken, the equipment releases audio and visual alarms in the default condition. You can activate or deactivate the audio alarm or release the alarm according to the speed of your vessel.

1. Press the **MENU** key to open the menu.
2. Open the [Alarms-General] menu.
3. Use the **RotoKey** to activate or deactivate the functions shown below.
[Speaker Alarm Output]: Activate or deactivate alarm output (from external speaker).
[Speed-Based Output]: Activate or deactivate alarm output according to the speed of your vessel.
[Speed-Based Output Value]: Set the speed at which alarms are output.
4. Press the **MENU** key to close the menu.

2.10.13 Alarm Log

The [Alarm-Log] menu shows the names, date and time that current and past alarms were broken.

Active alarms	
Date	Description
Oct/17/02 01:25:56 ...	Speed Alarm
↑	
Active alarm	

Alarms Log	
Date	Description
Oct/17/02 01:25:56 ...	Speed Alarm
Oct/17/02 01:20:42 ...	Speed Alarm
Oct/17/02 01:12:18 ...	Speed Alarm

} Past alarms

2.11 Track

The track (or movement) of your vessel is plotted on the screen with position data. Your track lets you see how your vessel has moved.

The track is saved to the hard disk if the track is active. A line runs between each track point. The hard disk stores a maximum 10,000 points. When the memory for track points becomes full, the oldest track points are deleted to get space for new track points.

Your track remains on the screen when the power is removed. You can delete the track that you do not need from the menu.

The saved track can be shown on the screen, and you can make a route with the saved track.

2.11.1 How to Show or Hide the Track Display

1. Push the **RotoKey** to show the soft controls.
2. Use the **RotoKey** to select [Track] then push the key to hide or show the track as necessary.

2.11.2 Track Recording Method, Interval

In drawing the track, the position of your ship is stored into the memory of this unit at an interval of time or distance. A shorter interval provides better reconstruction of the track, but the storage time of the track is reduced. When the track memory becomes full, the oldest track is erased to make room for the latest.

1. Press the **MENU** key to open the menu.
2. Open the [Ship & Track] menu.
3. Use the **RotoKey** to select [Track Interval].

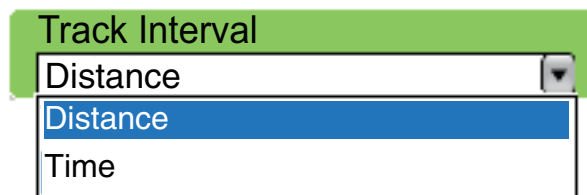

4. Use the **RotoKey** to select Distance or Time.
5. Use the **RotoKey** to select [Distance Interval] or [Time Interval], depending on your selection at step 4.

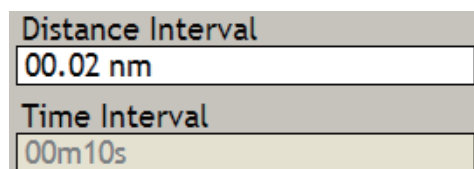

6. Use the **RotoKey** to enter a distance or time.
7. Press the **MENU** key to close the menu.

2.11.3 Track Thickness

You can set the thickness of the track to thin, medium or thick. If you are following the same track many times, you can show the track in the thinnest width to keep the screen clear.

1. Press the **MENU** key to open the menu.
2. Open the [Ship & Track] menu.

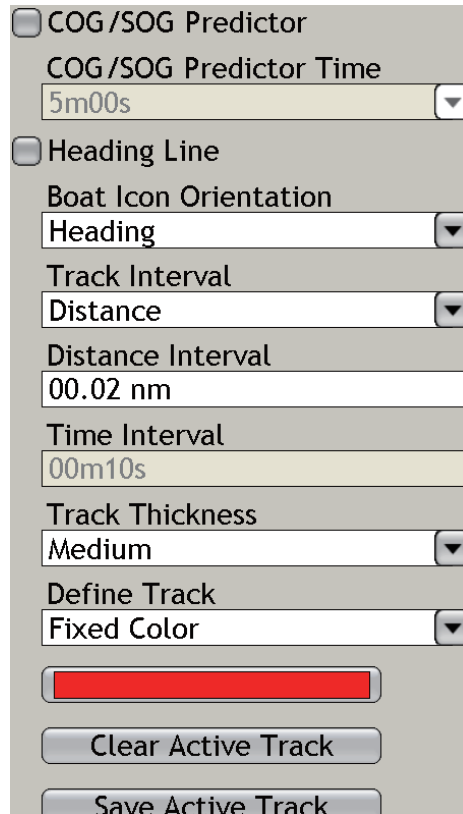

3. Use the **RotoKey** to select [Track Thickness].

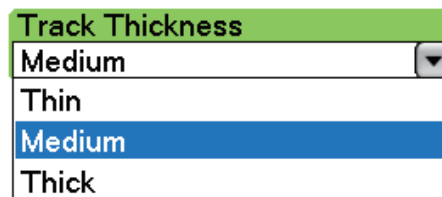

4. Use the **RotoKey** to select a thickness.
5. Press the **MENU** key to close the menu.

2.11.4 Track Color

Track can be displayed in a single color or multiple colors. For multiple colors, you can display the track according to the conditions shown below.

- Depth range
- Depth difference
- Sea surface temperature range
- Sea surface temperature difference
- Speed
- Date

To select the track color:

1. Press the **MENU** key to open the menu.
2. Open the [Ship & Track] menu.
3. Use the **RotoKey** both to select [Define Track] and open the options menu.

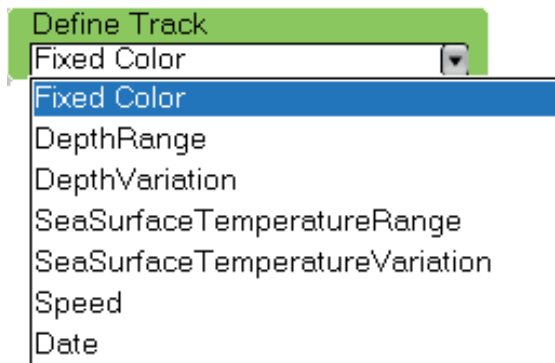

4. Use the **RotoKey** to select an option.
5. To change the settings, use the **RotoKey** to select the "color" box below [Define Track]. One of the menus shown on the next page appears.

6. Use the **RotoKey** to set values. Refer to the description below and on the next page.

White
Value: 033 ft
Blue
Value: 164 ft
Purple
Value: 328 ft
Cyan
Value: 656 ft
Green
Value: 984 ft
Yellow
Value: 999 ft
Red
OK

Depth range

White
Value: 41.00 °F
Blue
Value: 50.00 °F
Purple
Value: 54.50 °F
Cyan
Value: 59.00 °F
Green
Value: 63.50 °F
Yellow
Value: 68.00 °F
Red
OK

Sea surface temperature range

White
Value: 005.00 kt
Blue
Value: 010.00 kt
Purple
Value: 015.00 kt
Cyan
Value: 020.00 kt
Green
Value: 025.00 kt
Yellow
Value: 030.00 kt
Red
OK

Speed

White
Blue
Purple
Cyan
Green
Yellow
Red

Fixed color

Sunday
Monday
Tuesday
Wednesday
Thursday
Friday
Saturday

Date

Step: 002 ft
OK

Depth variation

Step: +00.20 °F
OK

Sea surface temperature variation

Fixed color: Single-color track in white, blue, purple, cyan, green, yellow and red.

Depth range: Change the color of the track with depth. Set the a depth limit for each color. For example, the default setting for white is 33 ft. For this setting, the track is white for depths to a maximum of 33 ft.

Depth variation: Paint the track in a different color when the depth changes by the figure set here. For example, the setting of 20 ft changes the color of the track as shown in the illustration when the depth changes by 20 ft.

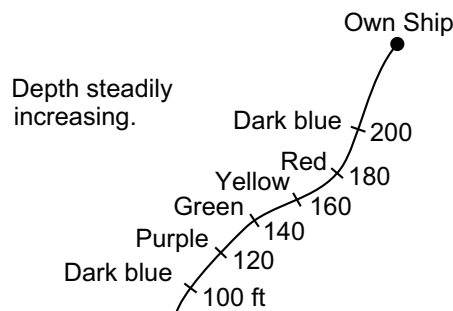

2. CHART PLOTTER

Sea surface temperature range: Change the color of the track with change in sea surface temperature. Set a limit for each color. For example, if the default setting for white is 41.0°F, the track is white for temperatures up to 41.0°F.

Sea surface temperature variation: Paint the track in a different color when the sea surface temperature changes by the figure set here. If the setting is +00.20°F, for example, the color of the track changes when the temperature of the sea surface changes by +00.20°F.

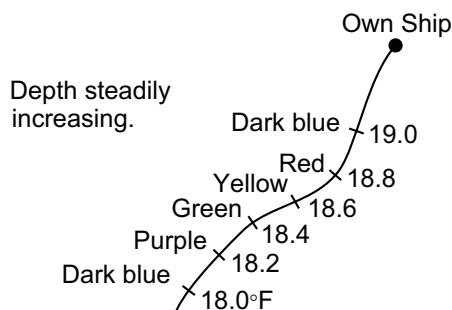

Date: The track color changes at the turn of a new day.

7. Press the **MENU** key to close the menu.

Note: For [Depth range], [Sea surface temperature range] and [Speed], track is shown in red for values higher than their largest setting.

2.11.5 How to Clear the Active Track

If the screen becomes full of track you can not know which is the newer track. Clear the track you do not need.

1. Press the **MENU** key to open the menu.
2. Open the [Ship & Track] menu.
3. Use the **RotoKey** to select [Clear Active Track] then push the key. You are asked if you are sure to reset the track.
4. Rotate the **RotoKey** to select [Yes] then push the key to erase the track.
5. Press the **MENU** key to close the menu.

2.11.6 How to Save Active Track

Your equipment saves a maximum of 10,000 track points. When the capacity for track points is reached, the oldest track is erased to clear space for the newest track. For that reason you can save your track, to the Track list. You can replay saved tracks to use the tracks to create a route.

1. Press the **MENU** key to open the menu.
2. Open the [Ship & Track] menu.
3. Use the **RotoKey** to select [Save Active Track]. You are asked to enter a name for the track.
You can select a name you have used, but the data saved under that name is erased.

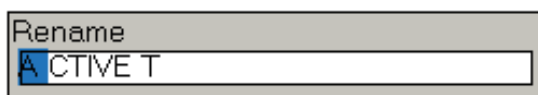

4. Use the **RotoKey** to enter name. Rotate the key to select a character then push the key to validate your selection. You can use a maximum of eight characters for the name. (To save the track under the name shown in the [Rename] box, push the **RotoKey** continuously until the box closes. Use the **RotoKey** to push the **OK** button.)
5. Press the **MENU** key to close the menu.

2.11.7 How to Replay a Saved Track

You can replay saved track on the display to use the track to create a route. The saved track appears with the current track. If the screen is full of active track, clear the active track before you replay the saved track to prevent clutter.

1. Press the **MENU** key to open the menu.
2. Open the [Ship & Track] menu.
3. Use the **RotoKey** to select [Open Saved Track]. The saved track list appears, an example of which is shown below.

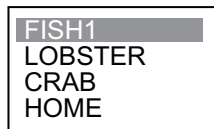

4. Use the **RotoKey** to select the track to replay.
5. Press the **MENU** key to close the menu and replay the track.

2.11.8 How to Remove a Replayed Track

After you have used a replayed track, you can remove the track from the screen as follows:

1. Press the **MENU** key to open the menu.
2. Open the [Ship & Track] menu.
3. Use the **RotoKey** to select [Close Saved Track].
4. Press the **MENU** key to close the menu.

2.11.9 How to Find Information About a Track

Simple track information provides the depth and temperature for the location selected on a track. (Depth and temperature sensors are required.) Put the cursor on any part of a track to get this information.

Detailed track information includes simple track information plus the information shown below. Press the **left-click** button to show detailed track information.

- Name of the track
- The time the track was started
- The time the selected point on the track was made
- Position at the selected location
- Depth and temperature at the position selected

Depth	40.7 ft
Temp	66.96 °F

Simple track information

Object Detail	
Name	ACTIVETRACK
Start Time	Oct/03/07 02:25:23 PM
Point Date	Oct/03/07 02:34:05 PM
Position	41° 42.8378' N; 70° 38.9505' W
Depth	47.6 ft
Temp	66.72 °F

Detailed track information

2.11.10 Track Pop-up Menu

The Track pop-up menu provides access to the track functions shown below. To show the Track pop-up menu, put the cursor on a track and press the **right-click** button.

Go to most recent track point. →	Trackback
Save track. →	Save Track
Clear track. →	Clear Track
Open Ship & Track menu. →	Parameters

Trackback

The trackback feature creates a route with your current track, and saves the track as a route, under the youngest empty route number. This feature helps you return along a previous track to get lobster pots, crab pots, and the like.

To use the trackback feature, put the cursor on a track and press the **right-click** button to open the Track pop-up menu. Trackback is selected then push the **RotoKey**. The trackback starts as shown below.

- A red dashed line runs between your vessel and the destination.
- A blue solid line connects between route points (automatically created) and your vessel.

- Arrows on the track point in the direction to follow the route.

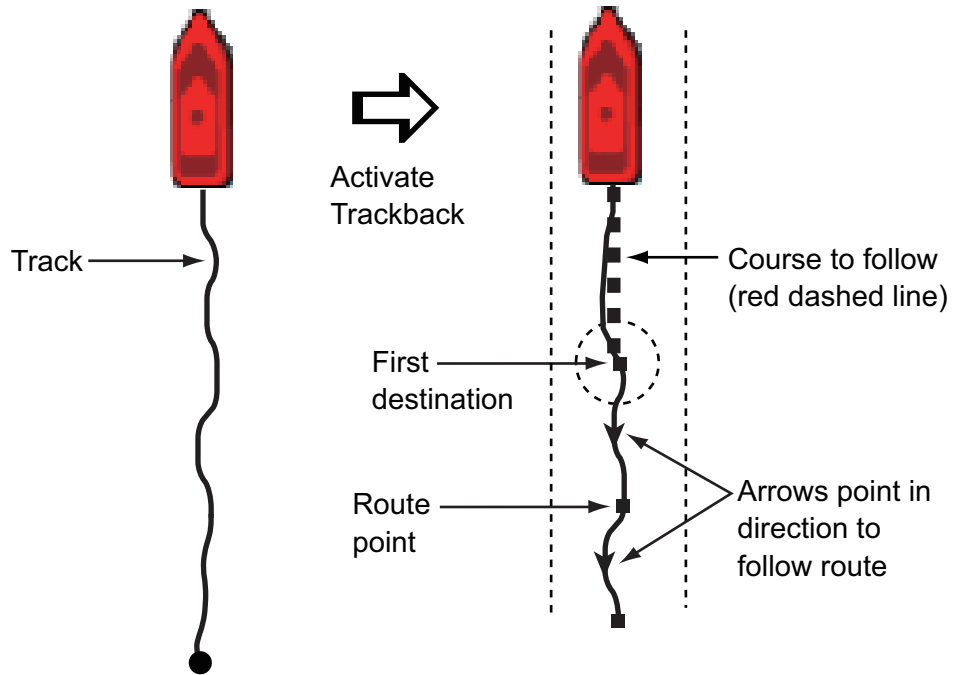

Trackback route following options

When you are following a route, you can do the following from the Route pop-up menu.

- Cancel the route.
- Restart following the route.
- Reverse the following direction.
- Put a point on the route.
- Change the position of the last point on the route.
- Find route information.

Push the **right-click** button to show the Route pop-up menu. For additional information, see the chapter 5.

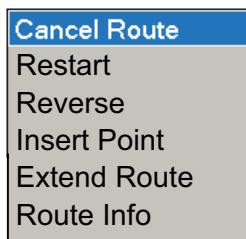

2. CHART PLOTTER

This page is intentionally left blank.

3. 3D DISPLAY, OVERLAYS

3.1 3D Display

The 3D display has native 3D chart design that allows full time 3D presentation. This true 3D environment gives you all of the information you require with no restrictions on the information you can see. You can plan your routes, enter points, etc. like on the 2D chart.

The 3D display provides a 3D view of land and sea around your vessel. Land is shown in different shades of light-brown according to height above the sea level. Water is shown in different shades of blue according to depth. The 3D display has most of the same information as the 2D display. With both presentations available you can see the conditions around your vessel from different angles. The 3D display helps you navigate when you are in waters that you do not know. Also, most functions of the 2D display, for example, destination setting, are available in the 3D display.

For best results make sure you have accurate position and heading data.

3.1.1 Aerial View

The aerial view is the view you get when you activate the 3D display. Your position is above and behind your vessel, and your view is in the forward direction. The illustration shown below provides an example of how you can change the orientation of the aerial view display. This illustration shows the view from port side of the vessel.

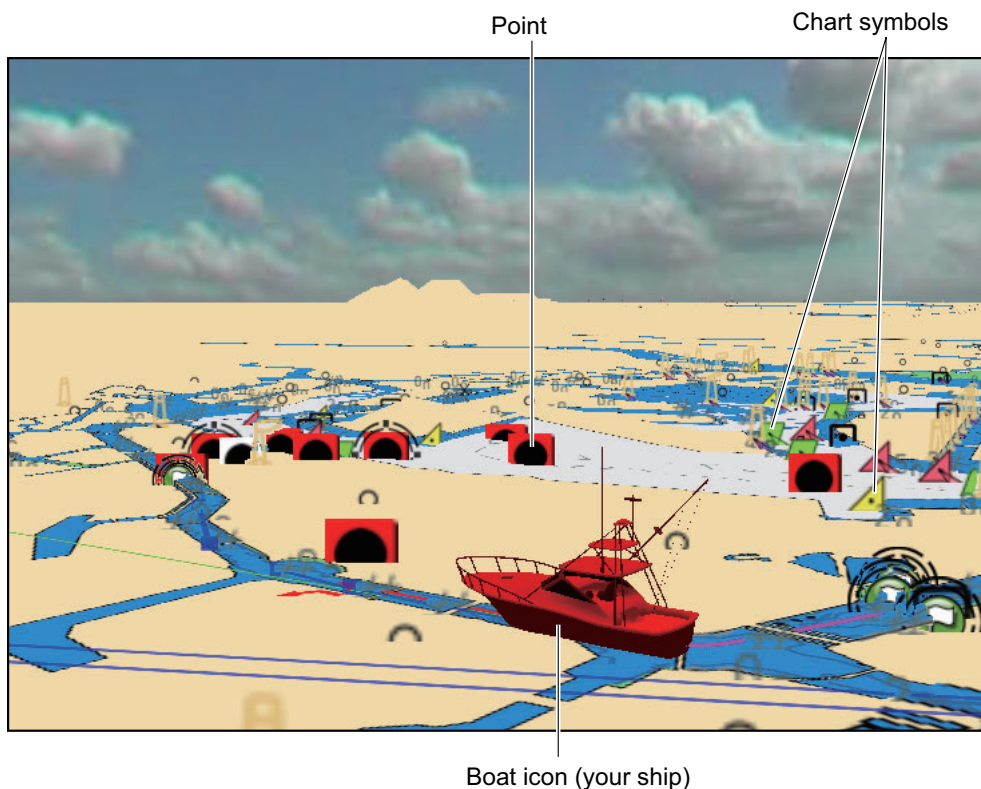

3D display, aerial view

How to activate and deactivate the aerial view by the SHIP/3D button

Before you do this procedure, open the [Chart-General] menu and activate [3D Pan/Tilt Mode]. This sequence allows you to adjust the pitch and orientation.

1. Long-push the **SHIP/3D** button to start the 3D display.
2. Rotate the **RotoKey** to adjust the pitch, i.e., the vertical angle of view. The range of adjustment is 1-90°.
3. Push the **RotoKey** to validate the setting.
4. Rotate the **RotoKey** to rotate the picture, from 0-360°.
5. Push the **RotoKey** to validate the setting.

Another method is to use the CursorPad to adjust the display. Use ▲ and ▼ to adjust the pitch and ◀ and ▶ to set the orientation. After you set the pitch and orientation, press the **left-click** button or push the **RotoKey**.

To readjust the display, first long-push the **RotoKey** and select the [3D] and [3D Pan/Tilt] soft controls. Readjust the display as shown in the above procedure.

To return to the 2D display, long-push the **SHIP/3D** button.

How to activate and deactivate the aerial view with the soft controls

1. Long-push the **RotoKey**.
2. Select the [3D] and [3D Pan/Tilt] soft controls. (You can also activate the display if you select the [Aerial View] soft control. Push the **RotoKey** to select the [3D Pan/Tilt] soft control.)
3. Adjust the display with the **RotoKey**, following steps 2-5 in the above procedure.

To readjust the display, long-push the **RotoKey** then select the [3D] and [3D Pan/Tilt] soft controls.

To restore the 2D display, push the **RotoKey** and select the [3D] and [2D View] soft controls.

3.1.2 Underwater Display

The underwater display provides a look into the water from above the water. This display is available between 7 yards and 1.003 nm.

To activate the underwater display, use the **RotoKey** to select the [3D] and [Underwater] soft controls. You can rotate the picture with ◀ and ▶ on the ScrollingPad.

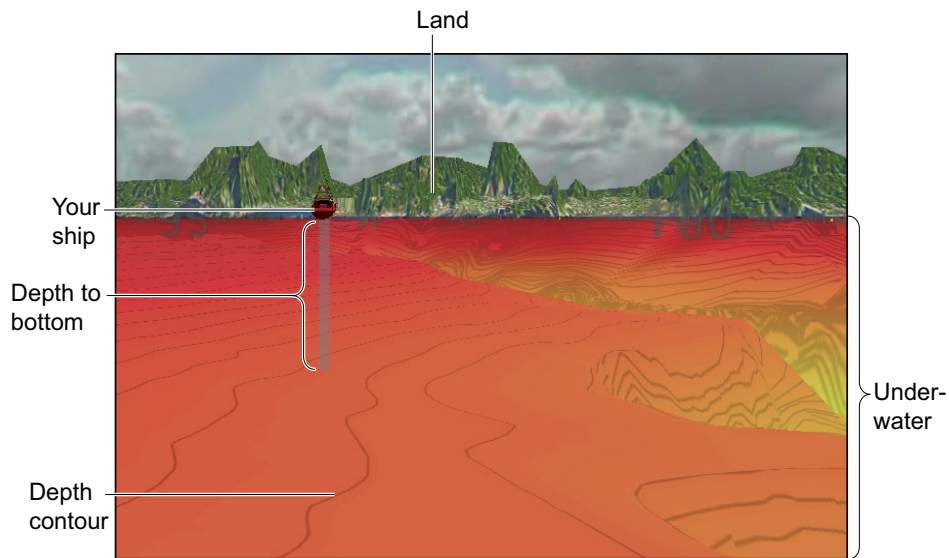

Underwater display

3.1.3 Highway Display

The highway display provides a 3-D view of own boat's progress toward destination. The range is automatically set to twice the value of the current XTE alarm setting. For example, if the XTE alarm setting is 100 m, the display range for the highway display is 200 m. To show the highway display, use the **RotoKey** to select [3D] and [Highway].

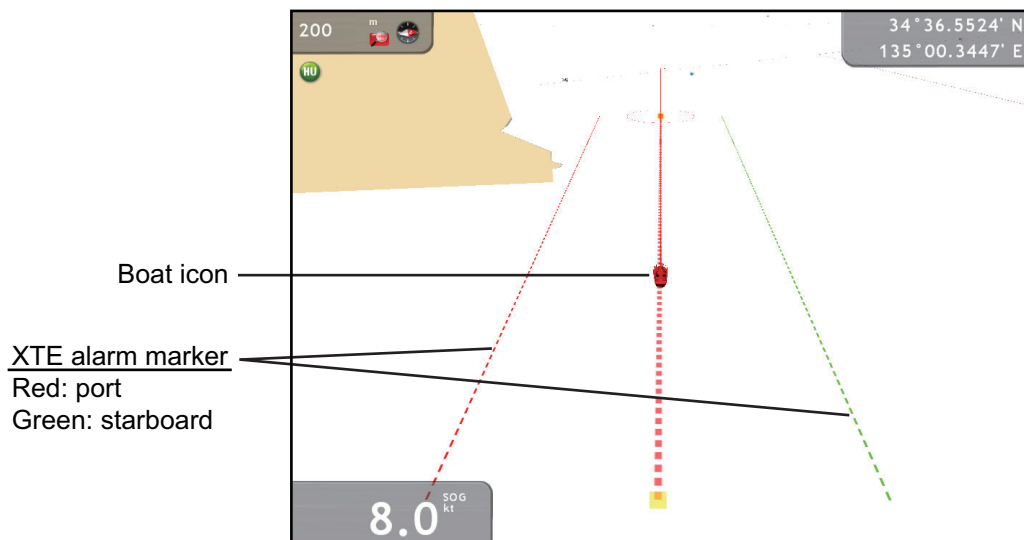

3.1.4 How to Make the 3D View Clearer

In the 3D display, some topographical features are easier to see if you use the “3D Exaggeration” feature. This feature expands both objects on the chart and the under-water vertically so that you can easily see the shape of the objects and position. To adjust the exaggeration feature, open the [Chart-General] menu and set the level with [3D Exaggeration]. See the available options in the figure shown below. High gives the highest level of exaggeration. The example below compares the same picture in low and high exaggerations.

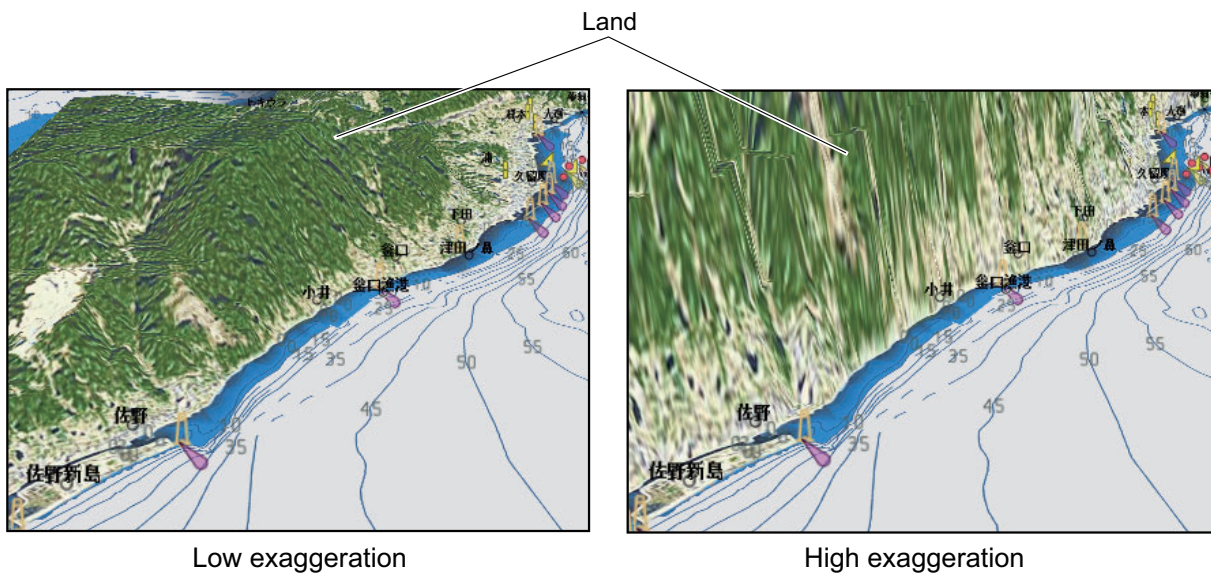
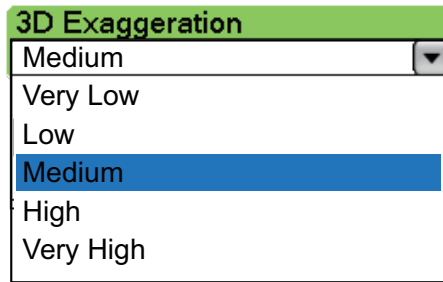

3.2 Overlays

Four chart overlays are available on the chart plotter display. These overlays are depth shading, weather, satellite photo, and animation.

3.2.1 Depth Shading Overlay

The depth shading overlay shows the depths in red (shallow), yellow (medium) and green (deep). This overlay is available in both 2D and 3D presentations. Use this overlay to find depths. Transparency levels can be adjusted so that the chart data is visible under the color shading. To show the depth shading overlay, first use the **RotoKey** to select [Overlay] and [Depth Shade]. Push the **RotoKey** to show or hide the depth shading overlay.

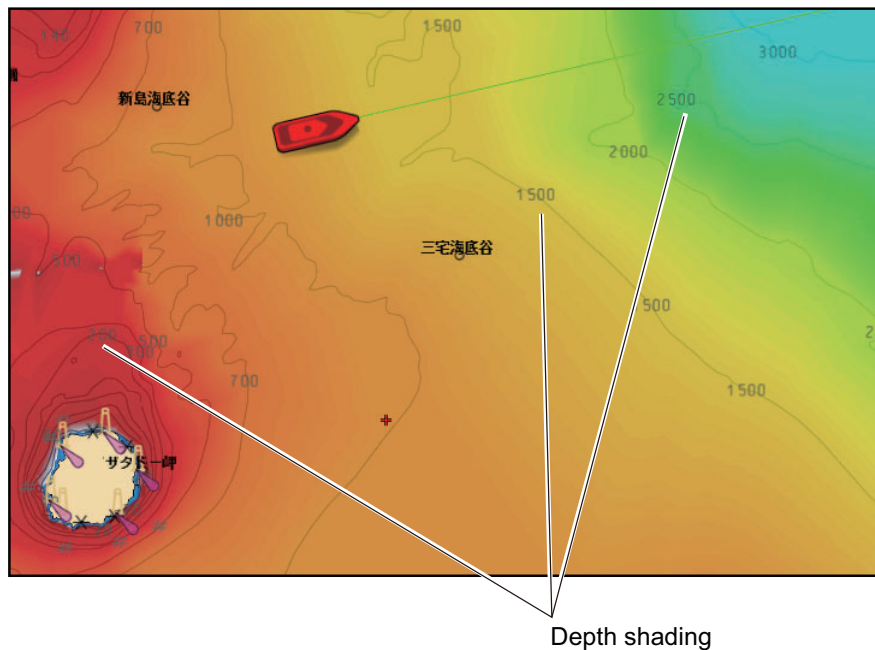

Depth shading settings

The depth shading settings are on the [Chart-General] menu. Set this menu by following the description shown below.

<input type="checkbox"/> Aerial View Bathymetry	—	Show/hide below-the-surface depth shading in the aerial view.
Depth Color Transparency	—	Adjust the transparency of depth color. The higher the figure the greater the transparency
<input type="checkbox"/> Auto Depth Color Scale	—	Turn automatic depth color scale selection on/off.
Depth Color Scale Style	—	Select how to display the depth colors.
Classic Hue	—	Classic Hue: Colors of the rainbow
Manual Depth Color Range	—	Blue Hue: Shades of blue
0000 ft; 0049 ft	—	Set the depth range for which to show depth shading.

*Chart menu, general sub menu
depth shading related items*

3.2.2 Weather Overlays

The weather overlays put weather information on the 2D and 3D displays. These displays are available only in North America and with connection of a Sirius weather receiver. Four types are available: Wx Radar, Wx Data, and Adv Wx Data, and Marine Zone. Use the **RotoKey** to select [Weather] and a weather soft control then push the **RotoKey** to hide or show the selected weather display. For detailed information about weather overlays, see chapter 11.

Weather radar overlay

NOWRAD and Canadian weather radar information are put on your chart. This overlay lets you see possible storm fronts to help you identify the clouds from possible sea clutter.

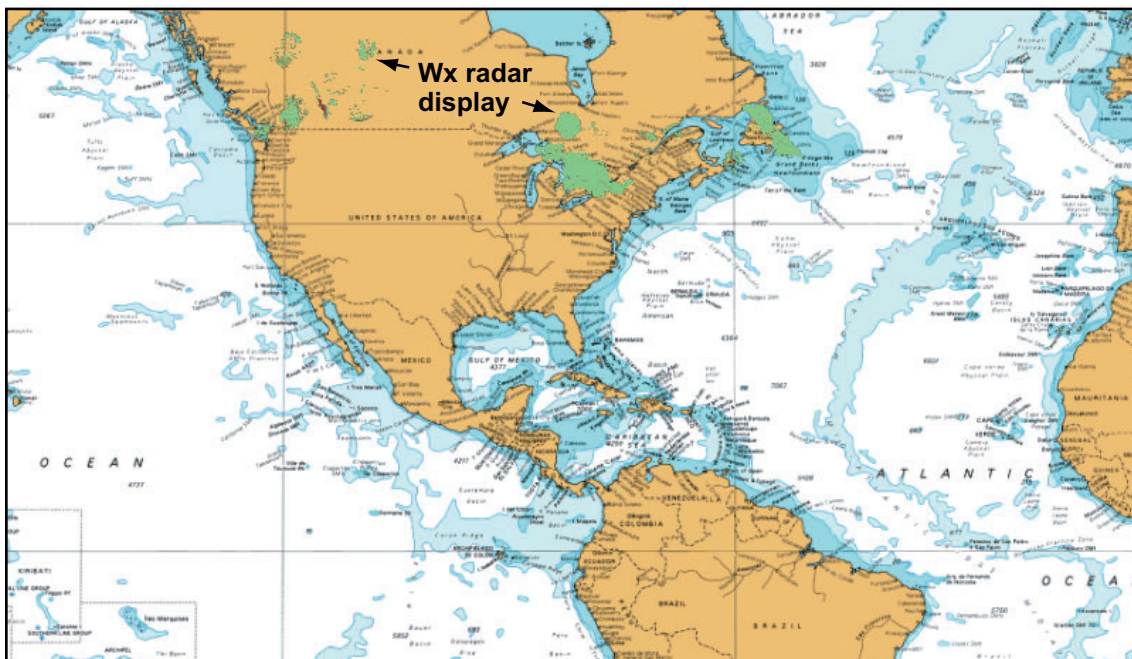

Weather data overlay

The weather data overlay provides forecast data that includes weather radar, sea surface temperature, storm tracks, pop-up weather alerts, etc.

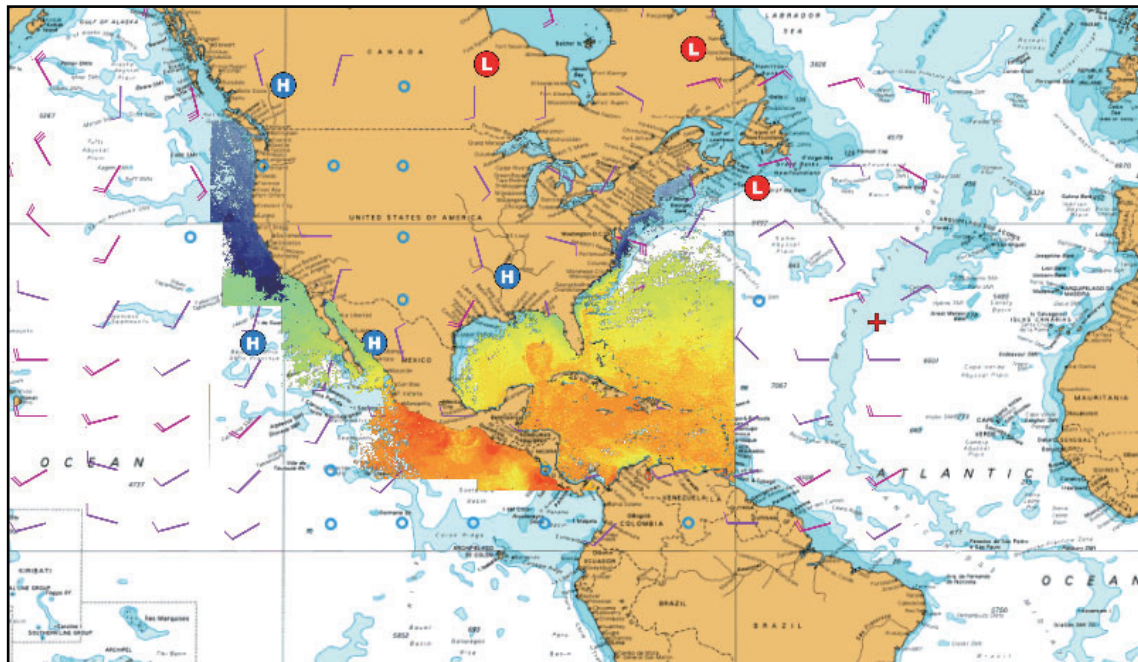

3. 3D DISPLAY, OVERLAYS

Advanced weather overlay

The advanced weather overlay provides the weather data not included in the standard weather data overlay, like buoys,

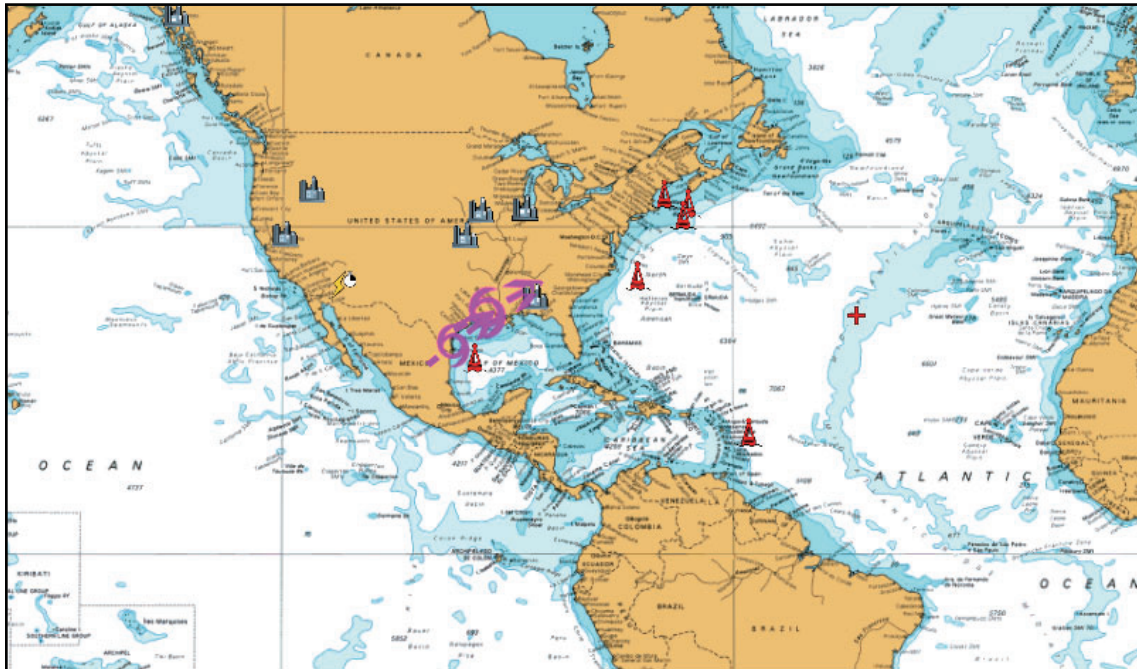

Marine zone overlay

The coastal waters are divided into zones for forecasts. These zones can be displayed on the screen with lines, like in the illustration shown below



3.2.3 Satellite Photo Overlay

You can put the satellite photo for your area on the 2D and 3D displays. Use the **RotoKey** to select [Overlay] and [Sat Photo] then push the **RotoKey** to show or hide the satellite photo.

High-resolution satellite images for the USA coastline are not provided standard, but are available at no cost (except shipping and handling). Users can install multiple satellite photos on the hard drive of the NavNet 3D. The illustration below shows the vector chart with the satellite photo overlay.

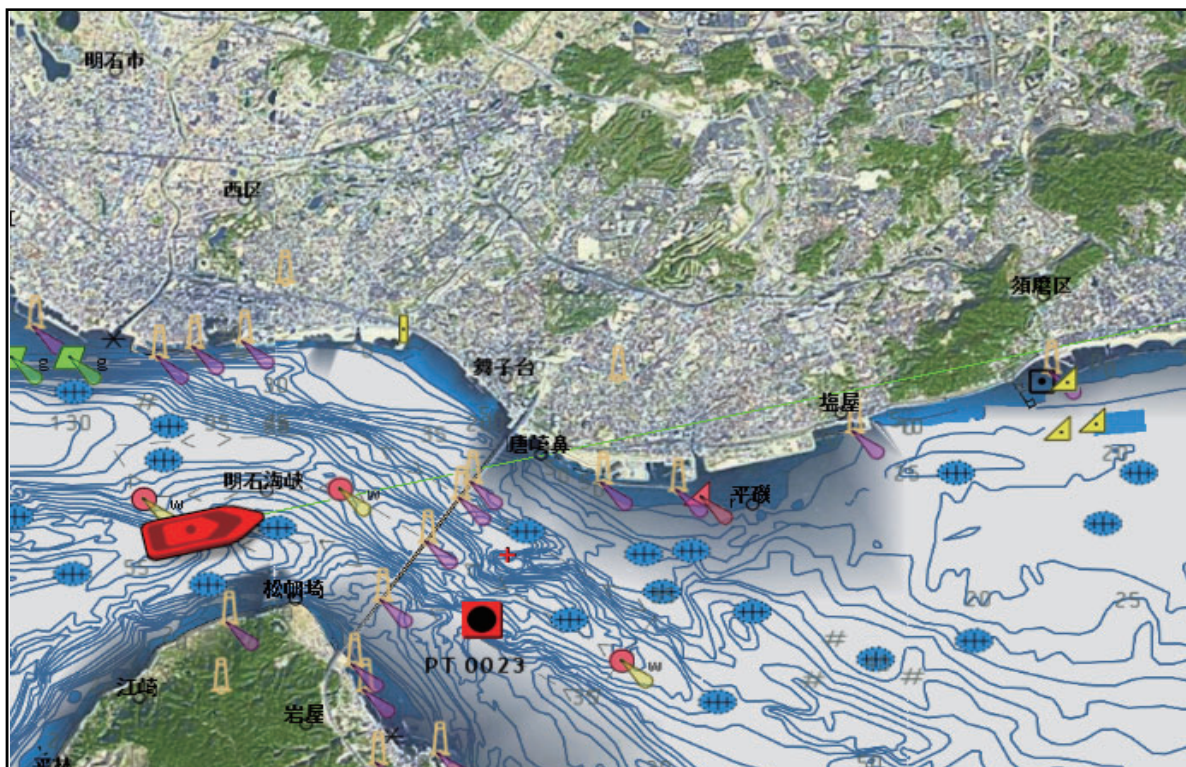

How to set photo transparency on water

You can set the level of transparency for the satellite photo on the water. Open the [Chart-General] menu. Use the **RotoKey** to select [Photo Transparency on Water] then push the **RotoKey**. Rotate the **RotoKey** to set the transparency level with the slider bar then push the key to validate the setting. You can see the results of the setting on the screen.



3.2.4 Animation Overlay

This overlay displays predicted wind, waves, or barometer information for a three-day period in three-hour intervals. The source for this overlay can be US NOWRAD or CAN NOWRAD. Select the source with [Weather Radar] on the [Weather-Sirius] menu. Long-push the **RotoKey**, select [Animate] then push the **RotoKey** to activate or deactivate the animation overlay.

3.2.5 Radar Overlay

The radar overlay display puts the radar picture on the top of the navigation chart. To display the radar overlay, use the **RotoKey** to select [Overlay] followed by [Radar]. Push the **RotoKey** to show or hide the radar overlay.

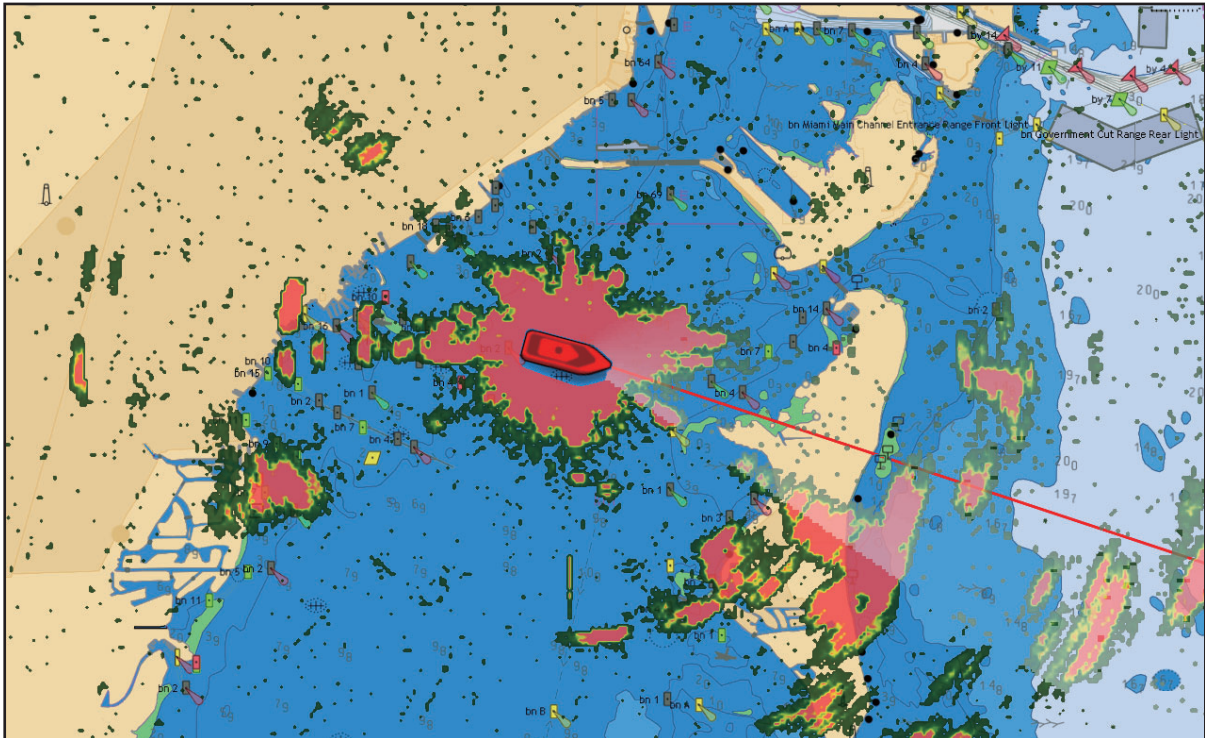

How to set the level of the radar echo transparency

Open the [Radar] menu and use the **RotoKey** to select [Echo Transparency for Overlay]. Rotate the **RotoKey** to set the level of transparency then push the **RotoKey**. You can see the result of the setting on the right half of the screen.



How to match the overlay and radar ranges

Open the [Radar] menu, and use the **RotoKey** to set [Overlay Range Link] for On or Off.

How to adjust radar gain, sea, rain

The gain and sea and rain clutters can be adjusted from the radar overlay. See section 6.2, section 6.3 or section 6.4 for the appropriate procedure.

How to control stand-by, TX

Push the **RotoKey**. Select [Tx] and push the **RotoKey** to get stand-by and TX alternately.

How to acquire a target for ARPA

A target can be acquired for ARPA. See paragraph 6.27.2 "How to Manually Acquire a Target" for the procedure.

3.2.6 Tidal Information Overlay

The NavNet 3D has worldwide tidal and tidal current information. You can overlay this information on the chart plotter display.

The tidal information symbol () appears at the locations of tidal recording stations. When you select a symbol, you get a graph of predicted maximum and minimum tide heights, and times for sunrise and sunset.

How to display the tidal information overlay

1. Push the **RotoKey** to show the soft controls.
2. Use the **RotoKey** to select [Overlay] followed by [Tide Icons].
3. Push the **RotoKey** to hide or show the tidal information overlay.

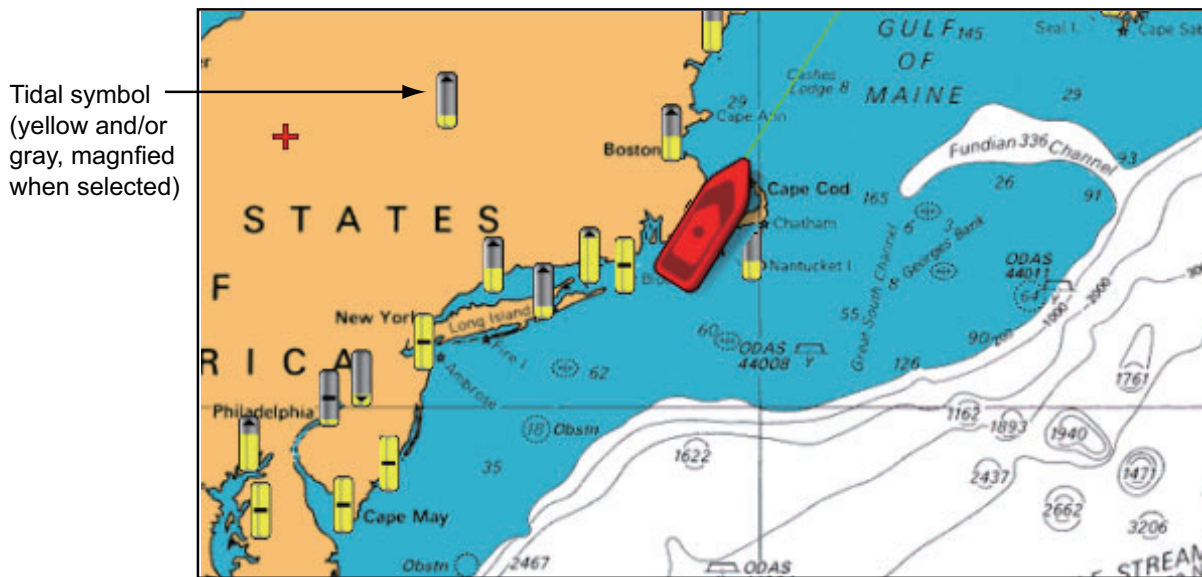

The arrow on the symbol is up when the tide is high, or is down when the tide is low. The symbol is gray and yellow according to tide state. The symbol is all yellow when the tide is high completely and all grey when the tide is low completely.

 : Up arrow indicates the tide is going high.

 : Down arrow indicates the tide is going low.

 : No arrow indicates no change in tide.

How to show simple tidal information

You can display simple information (name, local time and tide height) about a tide by when you put the cursor on a tide icon.

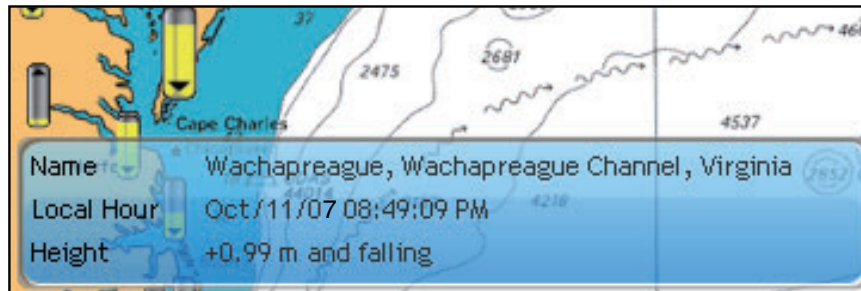

How to display the tide graph

The NavNet 3D has worldwide tide and current information. You can show the tide graph by three methods.

- Use the CursorPad to a tidal symbol then push the **left-click** button to show the tide graph.
- Use the CursorPad to select a tidal symbol, push the **right-click** button then select [Tide Graph] from the pop-up menu.
- Select the [Tide Graph] soft control to show the tide graph and get tidal information for the 10 closest tidal stations to current position.
- To return to the chart plotter display, use the RotoKey to select the **Exit** button on the tide graph, or press the **CANCEL** key twice.

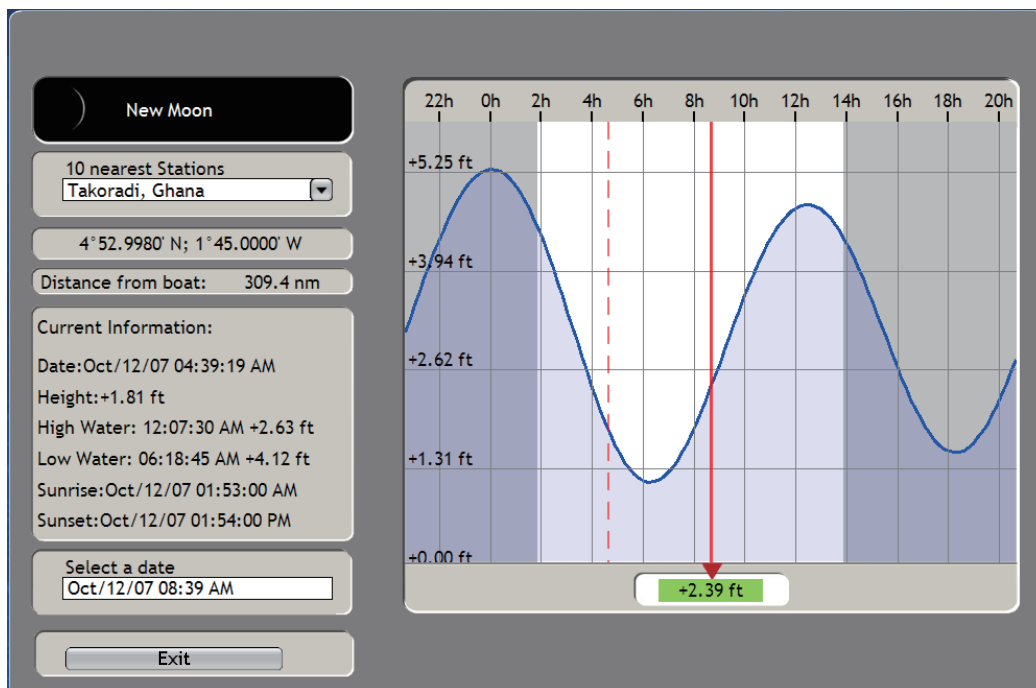

How to understand the tide graph display

- The information is mostly accurate under moderate weather conditions. However, storms and weather fronts can influence forecasted tide times and heights.
- The dotted vertical line on the graph functions to select a time for which the tide height is displayed. To change the time, rotate the **RotoKey**.
- To find the tide for 10 nearest stations, use the [10 Nearest Stations] combo box.
- To change the date, select [Select a date] and enter a date.
- To erase the tide graph and return to the chart plotter display, press the **CANCEL** key twice.

3.2.7 Tidal Current Overlay

The tidal current overlay is made from the tidal current data received from NOAA satellites, available in North America.

1. Push the **RotoKey** to show the soft controls.
2. Use the **RotoKey** to select [Overlay] followed by [Currents].
3. Push the **RotoKey** to show or hide the tidal current display.
Arrows of more than one color and size appear on the screen and are pointing in different directions.



The arrow indicates the movement of the tidal current. The size and color of the arrow indicate tidal current speed, Yellow, slow; orange, medium, and red, fast.

Simple and detailed NOAA-created tidal current information is available. For simple information put the cursor on a tidal current marker. Press the **left-click** button to get detailed information.

Name	Abiels Ledge , 0.4 mile south of
Local Hour	03/Oct/07 13:54:45
Speed	1.0 kt increasing

Simple tidal current information

Object Detail	
Name	Abiels Ledge, 0.4 mile south of
Local Hour	03/Oct/07 13:53:55
Speed	0.9 kt
Source	NOAA

Detailed tidal current information

4. POINTS

4.1 About Points

In navigation terminology, a point is any location you mark on the chart plotter display. A point can be a fishing spot, reference point and other important locations. You can use a point you have entered to set a destination.

This unit has 2,000 points into which you can enter position information. There are three methods that you can use to mark a point:

- At your current position
- At cursor position
- From a Points list

When you enter a point, the point is put on the screen with the default point symbol and the youngest empty point number. The position of the point, symbol and navigation information (range, bearing, etc.) are saved to the Points list. You can show or hide the points, and the default setting shows all points.

Default point symbol → 
(black circle in red square)

Point number → PT 0001
(black)

You can edit a point on the screen or the Points list. At the Points list you can change the symbol and its color, change position, etc.

4.2 How to Mark a Point

You can mark a point

- At current position
- At cursor position
- From the Points list

4.2.1 How to Mark a Point at Current Position

Press the **SAVE/MOB** key to mark a point at current position. The following occurs.

- The default point symbol is put at current position.
- The point is saved to the Points list under the youngest empty point number

4.2.2 How to Mark a Point at Cursor Position

POINTS/ROUTES key

Use the CursorPad to put the cursor on a location. Press the **POINTS/ROUTE** key. The default point symbol is put at the cursor position. The point is saved to the Points list and marked with the youngest empty point number.

Pop-up menu

You can also put a point at the cursor position with the Cursor Position pop-up menu, shown below. Use the **RotoKey** to select [New Point] then push the key to put a point at the cursor position.

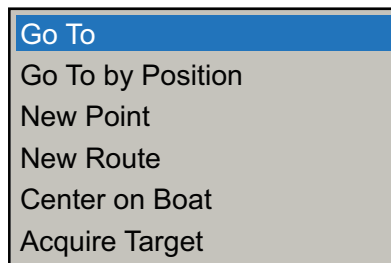

4.2.3 How to Mark a Point from the Points List

A point marked from the Points list is put at the current position. To put the point at a different location, edit the point data (position, symbol, etc.) before marking a point.

1. Long-push the **GO TO/LIST** key to show the [Points] menu.
2. Use the **RotoKey** to select any tab at the top of the menu. (You can select any tab when you mark a point.)

Sub menus (sort points according to name on tab)

Alpha: Points sorted in alphanumeric order

Local: Points sorted in distance from own ship, from near to far

Group: Points sorted in group alphabetical order

Icon: Points sorted by icon shape number order

Color: Points sorted by color in order of red, yellow, green, cyan, purple, blue, white

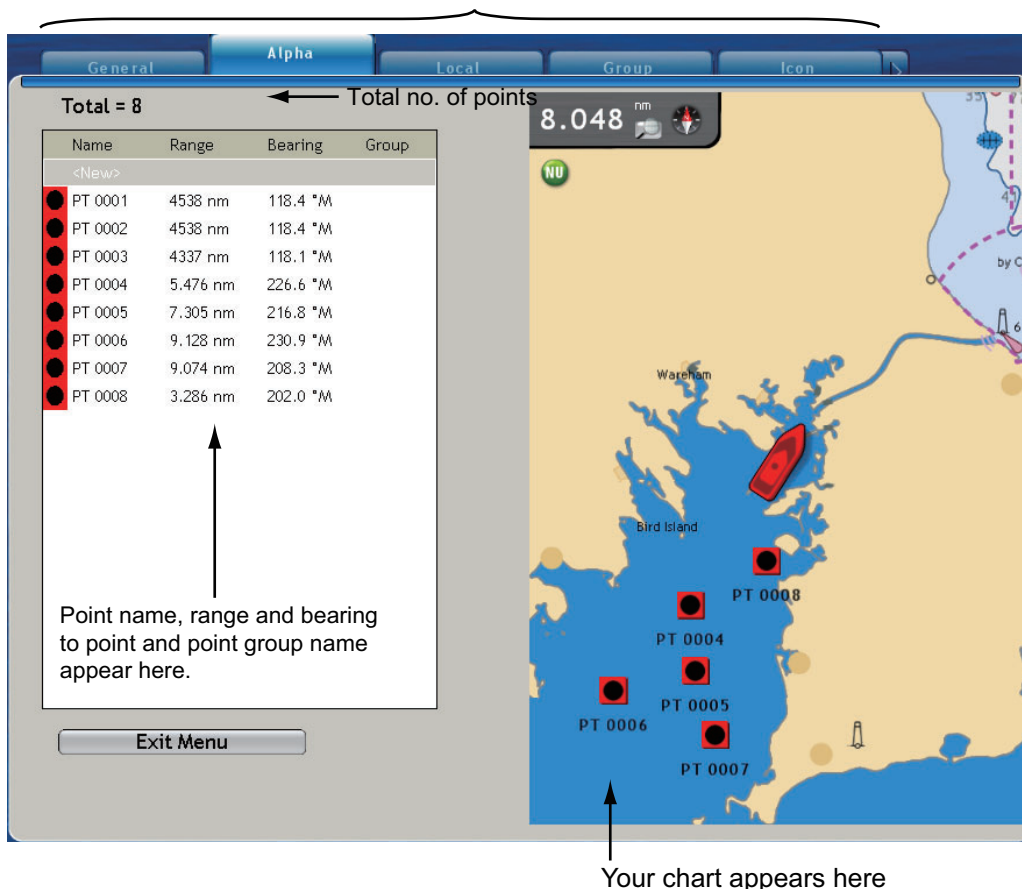

4. POINTS

- The cursor is selecting [Total]. Push the **RotoKey** twice then the right side of the display shows the point information like in the illustration shown below.

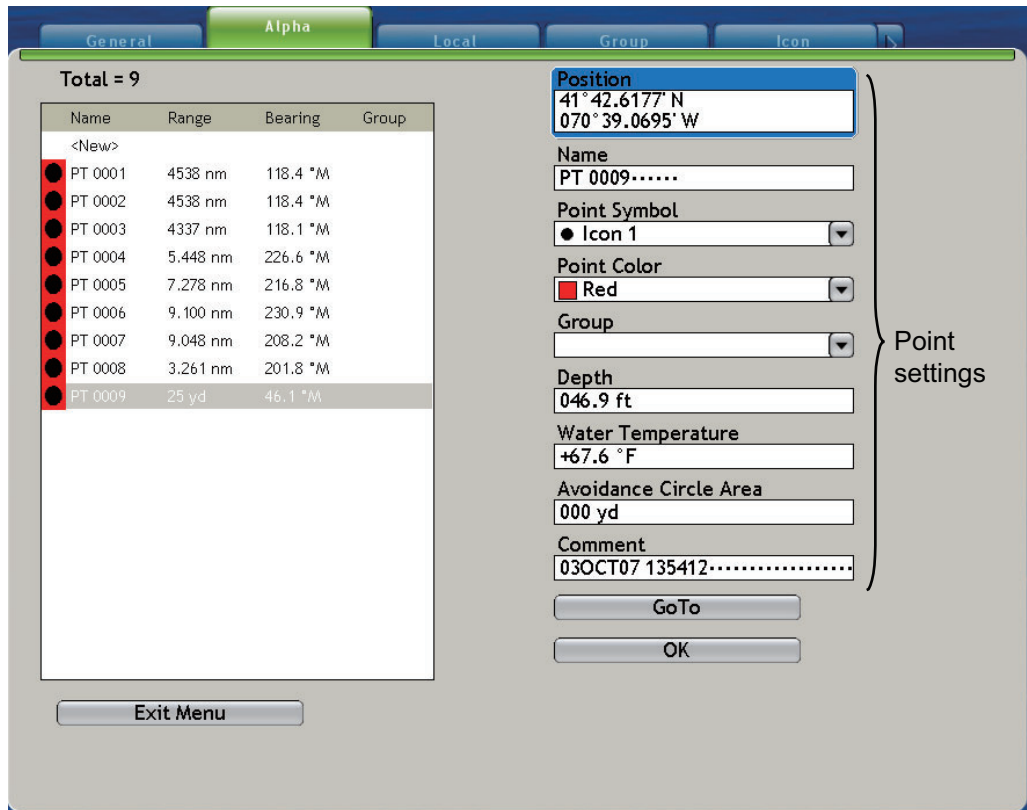

- If necessary, change the point settings. See section 4.7 "How to Edit a Point from the Points List".
- Use the **RotoKey** to click the **OK** button.
- Press the **MENU** key to close the menu.

4.3 How to Find Information About an On-screen Point

Put the cursor on a point. Simple point information (name, and range and bearing from your vessel) appears. To find detailed information, hit the **left-click** button. Detailed information includes simple information plus comment, depth and temperature at time of entry, group name and avoidance circle area.

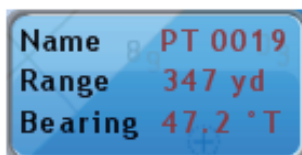

Simple point information

Object Detail	
Name	PT 0019
Comment	Oct0307 021603 PM
Range	347 yd
Bearing	47.2 °T
Depth	0.0 ft
Temp	32.00 °F
Group	
Avoidance Circle Area	0 yd

Detailed point information

4.4 Default Point Settings

When you save a point, the equipment saves the point according to the shape, color and group name set on the [Points-General] menu. If those settings do not meet your requirements, you can the settings as shown below.

1. Long-push the **GO TO/LIST** key to show the [Points] menu.
2. Select the [General] sub menu, shown below.

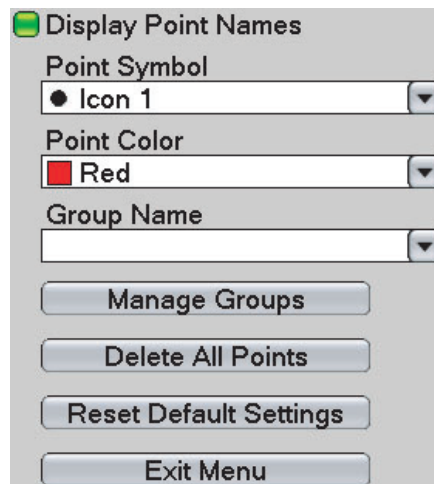

3. Use the **RotoKey** to select [Point Symbol], [Point Color] or [Group Name].

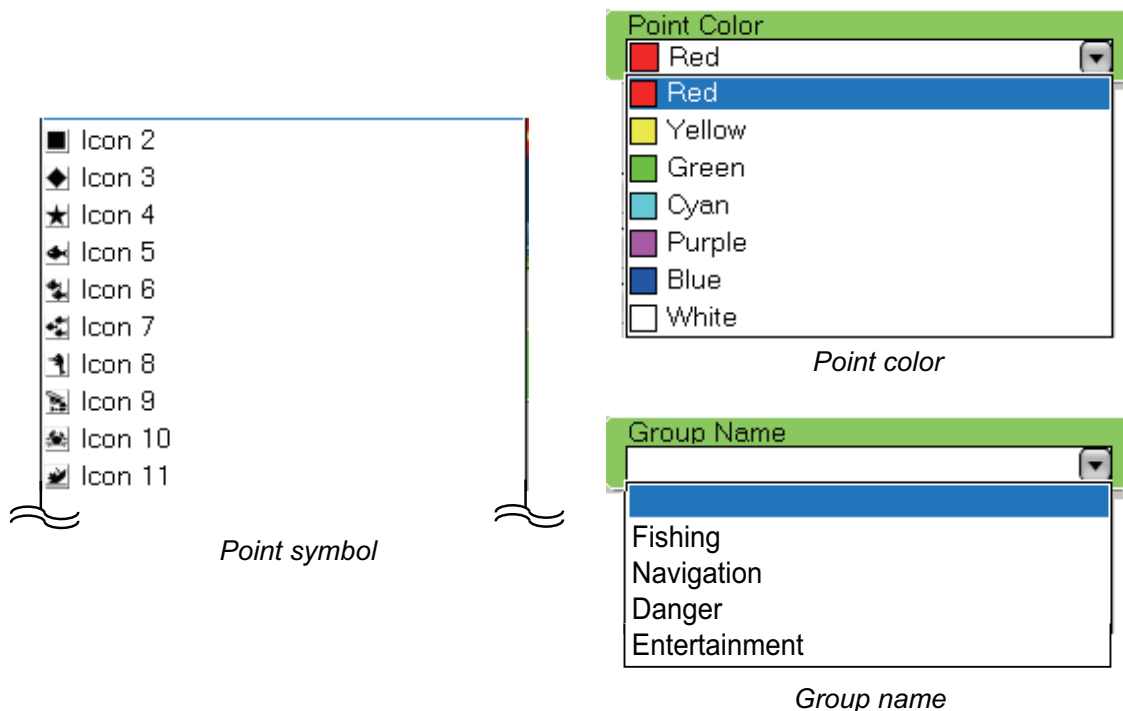

4. Use the **RotoKey** to select an option.
5. Press the **MENU** key to close the menu.

4.5 How to Move a Point

You can move a point by two methods:

- Move the symbol to a new location.
- Enter new position manually on the [Points] list.

4.5.1 How to Move an On-screen Point

1. Set the cursor on the point to move. The point becomes larger if the point is selected correctly.
2. Hit the **right-click** button to show the Point pop-up menu.

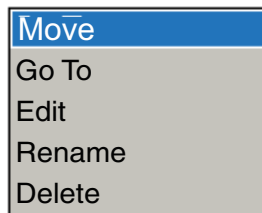

3. [Move] is selected. Push the **RotoKey**.
4. Use the CursorPad to move the symbol to the new location. Push the **RotoKey** to put the symbol at the new location.

4.5.2 How to Move a Point from the Points List

1. Long-push the **GO TO/LIST** key to open the [Points] menu then open the Alpha list.
2. Use the **RotoKey** to select the point to edit.
3. Push the **right-click** button or the **RotoKey** to show the Point Edit pop-up menu.

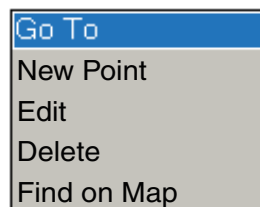

4. Rotate the **RotoKey** to select [Edit] then push the **RotoKey**. The point information replaces the chart.
5. The [Position] combo box is selected. Push the **RotoKey**.

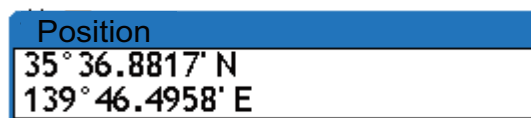

6. Enter position with the **RotoKey**. Push the **RotoKey** to select the location. Rotate the **RotoKey** to select a digit then push the **RotoKey** to validate your selection.
7. Rotate the **RotoKey** to select the **OK** button at the bottom of the display then push the **RotoKey**.

4.6 How to Delete a Point

You can delete points by two methods, on the screen and from a Points list.

4.6.1 How to Delete a Point on the Screen

Method 1: CANCEL key

Put the cursor on the point to delete and press the **CANCEL** key.

Method 2: Pop-up menu

1. Put the cursor on the point to delete.
2. Push the **right-click** button to show the Points pop-up menu.
3. Rotate the **RotoKey** to select [Delete].
4. Push the **RotoKey** to delete the point from both the screen and the Points list.

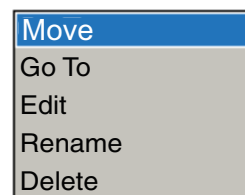

Note: An icon something like the shown below appears when two or more points are near one another and cannot be show separately on the current range. Zoom in to separate the points then select the point to delete.



4.6.2 How to Delete a Point from the Points List

1. Long-push the **GO TO/LIST** key to show the [Points] menu then open a Points list.
2. Use the **RotoKey** to select the point to delete then push the **RotoKey**. The Points List pop-up menu appears.
3. Rotate the **RotoKey** to select [Delete].
4. Push the **RotoKey** to delete the point from both the screen and the Points list.

4.6.3 How to Delete All Points

You can delete all points from the [Points] menu. A point currently used in navigation cannot be deleted.

1. Press the **MENU** key to open the menu.
2. Open the [Points-General] menu.
3. Use the **RotoKey** to select [Delete All Points].
4. Rotate the **RotoKey** to select [Yes] then push the **RotoKey**.

4.7 How to Edit a Point from the Points List

You can edit the points you have entered from the [Points] menu. You can select the point to edit on-screen, or from a Points list.

1. On the screen, use the CursorPad to select the point to edit, push the **right-click** button and select [Edit] from the pop-up menu. (You can also select the point if you long-push the **GOTO/LIST** key.) Settings for the point selected appear on the right-half of the screen.

The screenshot shows a vertical menu for editing a point. The 'Position' field is highlighted with a blue border and contains the coordinates 12°40.5548' N and 023°46.1584' W. Below it are fields for Name (PT 0001), Point Symbol (Icon 1), Point Color (Red), Group, Depth (000.0 m), Water Temperature (+00.0 °C), Avoidance Circle Area (000 m), and Comment (DEC1207 125248 AM). A bracket on the right side of the menu is labeled 'Point attributes'.

2. The [Position] combo box is selected. If necessary, change position.
3. To change the name of the point, select the [Name] box. Change the name as follows:
 - 1) Push the **RotoKey** to select the character to edit then push the **RotoKey**.
 - 2) Rotate the **RotoKey** to select an alphanumeric character then push the **RotoKey**.
 - 3) Repeat steps 1 and 2 to complete the name. A name can include a maximum of 13 alphanumeric characters.
4. Select [Point Symbol] to change the point symbol. 32 symbols are available.

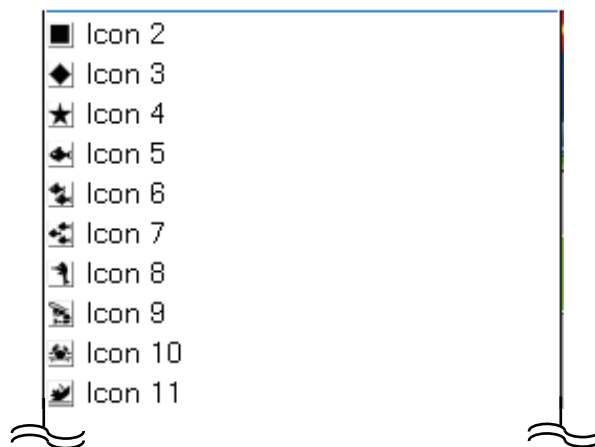

5. Select [Point Color] to change the color of the square part of the point symbol. Seven colors are available: red, yellow, green, cyan, purple, blue, and white.

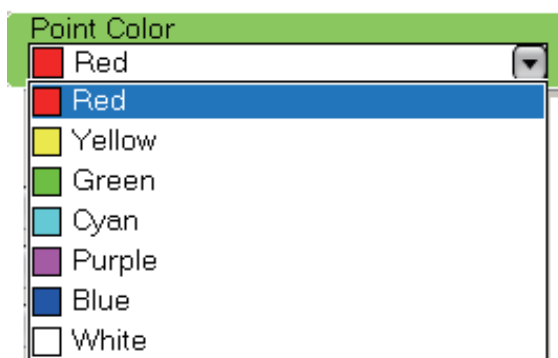

6. Select [Group] to put the point in a point group. [Fishing], [Navigation], [Danger] and [Entertainment] are the default groups.

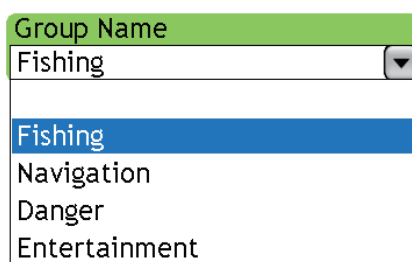

7. [Depth] and [Water Temperature] are the depth and water temperature at the point location. (You need depth and water temperature data to show this data.) If necessary you can change this data.
8. [Avoidance Circle Area] sets the distance for the proximity alarm, which tells you when your vessel is near a point by the distance set here. For additional information about the proximity alarm, see the section on the chart plotter alarms.
9. Use [Comment] to enter a comment about a point. You enter a comment like you do a Name. A comment can include a maximum of 64 alphanumeric characters.
10. The **GoTo** button functions to set a point as the GoTo point. Select this button then push the **RotoKey** to go to the point.
11. To finish, select the **OK** button then push the **RotoKey**.

4.8 How to Find a Point

4.8.1 How to Show a Point at the Center of the Screen

You can easily move a point to the center of the screen if you select it on the [Points] menu.

1. In the chart plotter mode, long-push the **GO TO/LIST** key to open the [Points] menu then open a Points list.
2. Select a point then push the **RotoKey**. The Points List pop-up menu appears.
3. Use the **RotoKey** to select [Find on Map].
4. The menu is closed and the point selected is put at the center of the screen on the active chart plotter display.

4.8.2 How to Find the Location of a Point from the Points Menu

Select a point from a Points list. The point is put at the center of the chart to the right of the menu.

4.9 Point Groups

You can put points in point groups according to their purpose. The default point groups are danger, fishing, navigation, and entertainment. You can delete these groups, or add new groups. A maximum of 10 groups is available, which includes the default groups.

1. Press the **MENU** key to open the menu.
2. Open the [Points-General] menu.
3. Use the **RotoKey** to select the [Manage Groups] button.

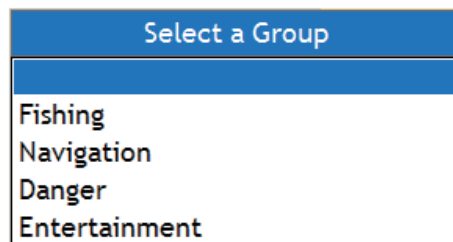

4. Use the **RotoKey** to select a group name then push the **RotoKey**.

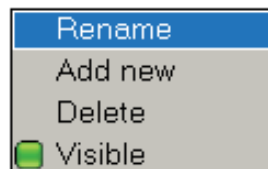

5. Select the item related to your purpose then push the **RotoKey**.
 - **Rename.** Rename the selected group. Use the **RotoKey** to change the name. Push the **RotoKey** to select a location, rotate it to select character then push the key to validate your selection.



- **Add new.** Add new group. The default group name is GROUP XXX (XXX=next three-digit group number).
 - **Delete.** Delete selected group name. Points in the group are not deleted.
 - **Visible.** Control visibility of points in a group.
6. Press the **MENU** key to close the menu.

4.10 How to Show or Hide All Points

You can show or hide all points. A point which is currently used in navigation cannot be removed from the screen until the navigation is stopped.

1. Long-push the **RotoKey** to show the soft controls.
2. Use the **RotoKey** to select [Points].
3. Select [Show] then push the **RotoKey** to show or hide all points.

4.11 How to Go to a Point

Select the point to go to from the three methods shown below.

- Select the point on the screen
- Select the point from a Points list
- Select the point with the cursor

After you have selected a point, you can do the following.

- Restart the cross-track error (XTE) indication.
- Stop and restart Go To.

Before you try to go to a point, make sure that the path to the point is clear. Make sure to zoom your chart to check for hazards which appear on a smaller scale.

4.11.1 How to go to an On-screen Point

1. Use the CursorPad to select the point.
2. Push the **right-click** button to show the Points pop-up menu.
3. Use the **RotoKey** to select [Go To].

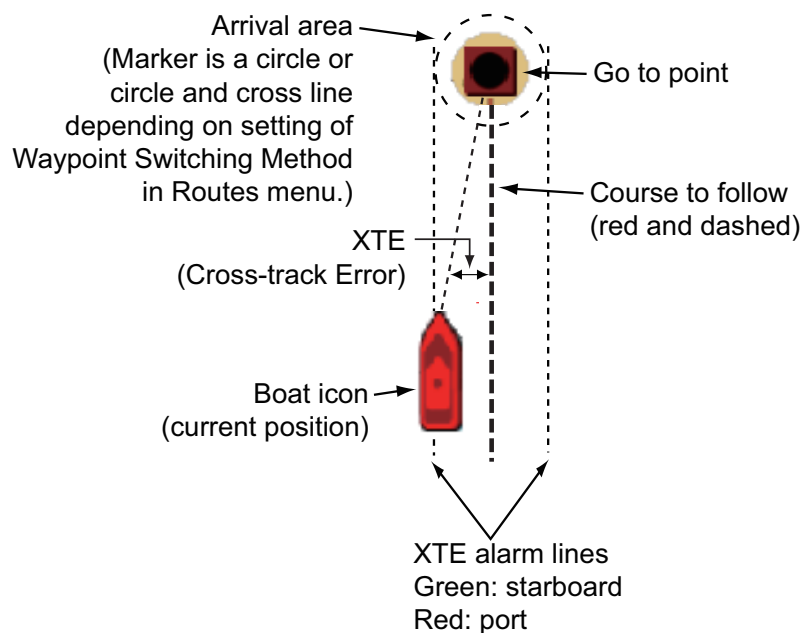
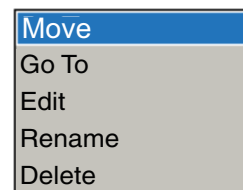

A red dashed line runs between current position and the point. This line is the course to follow to get to the point. The point arrival area is indicated with a circle, or both circle and line. You can select the arrival area indication method with [Waypoint Switching Mode] in the [Routes-General] menu. To receive an aural alarm when you are within a preset distance, turn on [Waypoint Notification] and set [Switching Circle Radius] on the [Routes-General] menu. The XTE alarm lines, red for port side, green for starboard side, show the XTE alarm range. You can show or hide these lines with [XTE Alarm Lines] in the [Routes-General] menu.

The route is saved to the Routes list under the next route number, but is deleted when you turn off the system.

4.11.2 How to go to Cursor Position

The benefit of using the cursor position as a point to go to is you do not have to save the point. The point is erased when the navigation is cancelled.

GO TO/LIST key

Put the cursor on the location then push the **GO TO/LIST** key. Use the **RotoKey** to select [Go To] or [Go To by Position]. To set the position accurately, use [Go To by Position]. Set the position in the [Validate position] box with the **RotoKey**. Push the key to select the location in the box, rotate the key to set value, then push the key to validate the position.

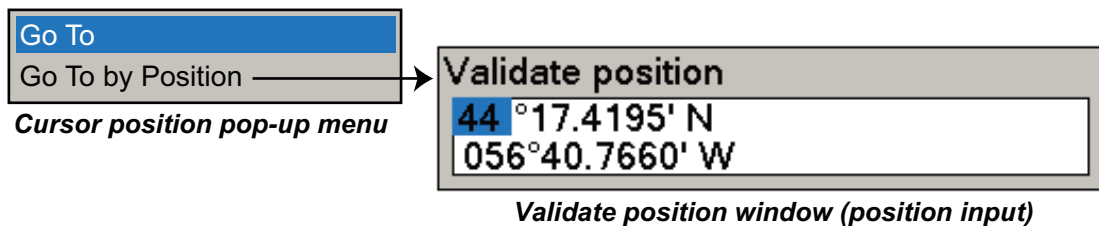

Pop-up menu

Put the cursor on the location then push the **right-click** button to show the Cursor Position pop-up menu. Use the **RotoKey** to select [Go To] or [Go To by Position]. To set the position accurately, use [Go To by Position]. Set the position in the [Validate position] box with the **RotoKey**. Push the key to select the location in the box, rotate the key to set value, then push the key to validate the position.

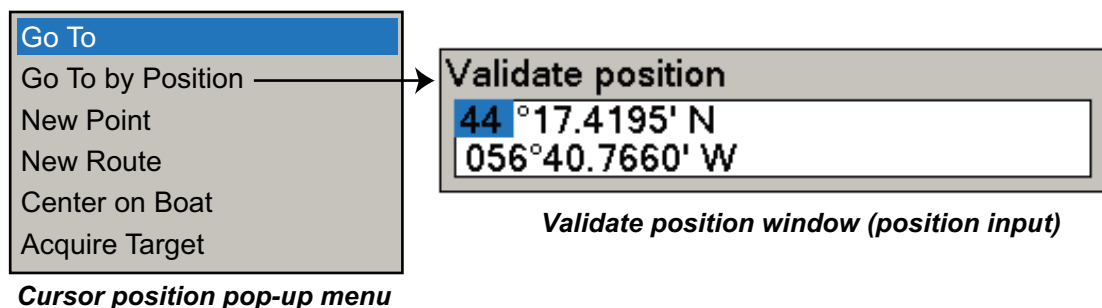

4. POINTS

A red dashed line runs between current position and the point. This line is the course to follow to get to the point. The point arrival area is indicated with a circle, or both circle and line. You can select the arrival area indication method with [Waypoint Switching Mode] in the [Routes-General] menu. To receive an aural alarm when you are within a preset distance, turn on [Waypoint Notification] and set [Switching Circle Radius] on the [Routes-General] menu. The XTE alarm lines, red for port side, green for starboard side, show the XTE alarm range. You can show or hide these lines with [XTE Alarm Lines] in the [Routes-General] menu.

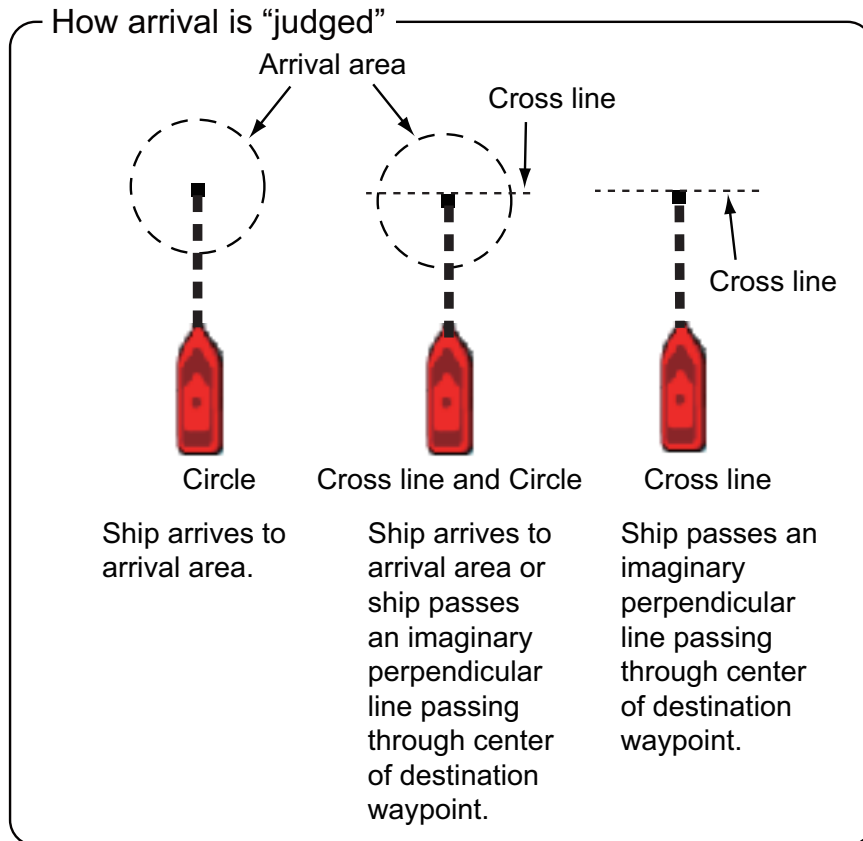
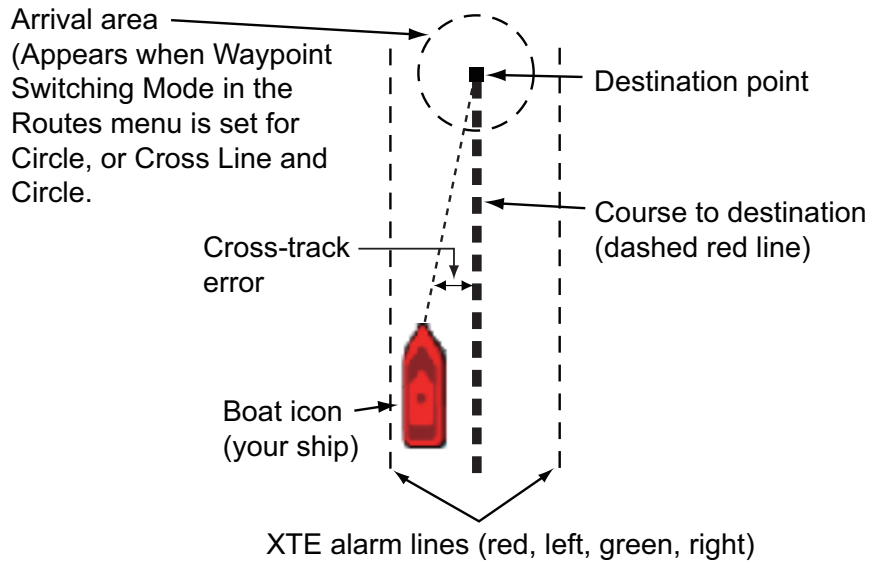

4.11.3 How to go to a Point Selected from the Points List

1. Long-push the **GO TO/LIST** key to open the [Points] menu then open the Alpha list.
2. Use the **RotoKey** to select a point.
3. Push the **RotoKey** to show the [Points] Menu pop-up. The cursor selects [Go To]. Push the **RotoKey**.

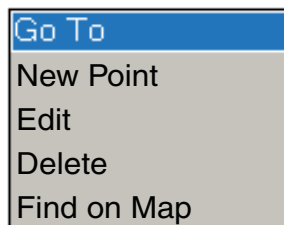

The menu is erased and the chart plotter display appears. A red dashed line runs between current position and the point. This line is the course to follow to get to the point. The point arrival area is indicated with a circle, or both circle and line. You can select the arrival area indication method with [Waypoint Switching Mode] in the [Routes-General] menu. To receive an aural alarm when you are within a preset distance, turn on [Waypoint Notification] and set [Switching Circle Radius] on the [Routes-General] menu. The XTE alarm lines, red for port side, green for starboard side, show the XTE alarm range. You can show or hide these lines with [XTE Alarm Lines] in the [Routes-General] menu.

4.11.4 How to Extend a Route Made with a Single Point

If you have made a route with a single point and you need to go other locations, you can easily extend the route as follows.

1. Use the CursorPad to put the cursor on the dashed line of the route.
2. Push the **right-click** button to show the Route Follow pop-up menu.
3. Use the **RotoKey** to select [Extend Route].
4. Set the cursor on a new location and push the **left-click** button.
5. Repeat step 4 to add additional points.
6. Push the **RotoKey** to finish.

4.12 How to Restart and Cancel Navigation to a Point

4.12.1 Restart Navigation

When you go to a point, you can restart the navigation to the point from current location.

When you steer to keep away from an obstruction or the vessel drifts, you go off course as shown in Line 1 in the figure. If you do not need to return to the original course, you can go to the point from the current position as shown in Line 2 in the figure.

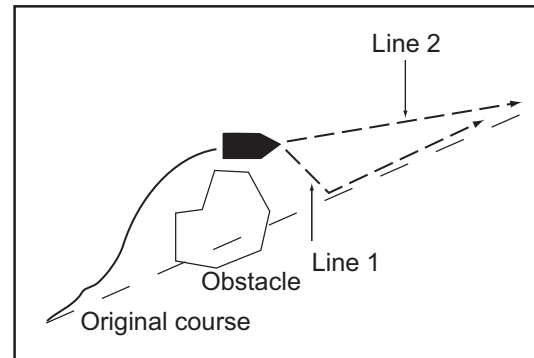

1. Use the CursorPad to put the cursor on the dashed line of the route.
2. Push the **right-click** button to show the Route Follow pop-up menu.

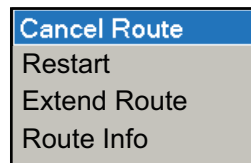

3. Use the **RotoKey** to select [Restart].
The route start position for the route moves to the current position and the XTE becomes zero.

4.12.2 How to Cancel Navigation to a Point

1. Use the CursorPad to put the cursor on the dashed line of the route.
2. Push the **right-click** button to show the Route Follow pop-up menu.
3. Use the **RotoKey** to select [Cancel Route].

The dotted line from your vessel to the point is erased from the screen. To again go to the point:

- 1) Select the point on the screen.
- 2) Open the Points pop-up menu.
- 3) Select [Go To] then push the **RotoKey**.

Navigation is then restarted from the point at which the navigation was stopped.

5. ROUTES

5.1 What is a Route?

A route is a series of points entered in the order to use for navigation. A route can contain up to a maximum of 100 points, and this equipment stores 200 routes.

You create a route by pointing and clicking geographical positions on the screen. These positions are marked with blue solid circles.

You can follow a route that you have created if you use the GOTO feature. When you follow a route, the current leg is shown as a dotted line and previous legs are erased from the screen.

On-screen routes can be edited from the Routes pop-up menu. With this pop-up menu, you can

- Enter points in a route
- Move points in a route
- Delete points from a route
- Extend a route a route
- Split routes
- Find information about a route
- Set a route as destination
- Delete a route
- Follow a route in reverse direction
- Ignore a route point when following a route

5.2 How to Create a Route

5.2.1 How to Create a New Route

The route points of an inactive route are marked on the display with a blue square and a blue line runs between points.

1. Put the cursor on the 1st point for the route.
2. Push the **right-click** button to show the Cursor Position pop-up menu.

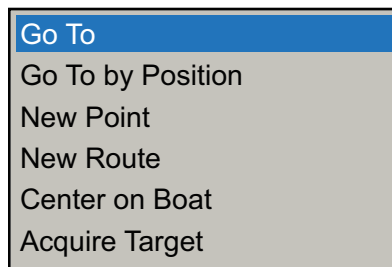

3. Use the **RotoKey** to select [New Route].
4. Use the CursorPad to move the cursor to the next point in the route. When you move the cursor, a blue dashed line runs between the previous point and the cursor location. See the figure shown below.

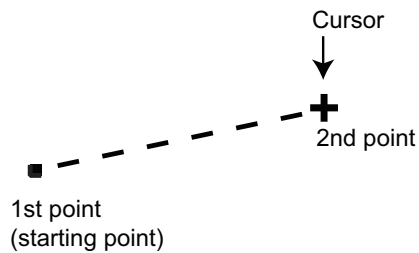

5. Press the **left-click** button to save the point. The line between the first point and second point changes from dashed to solid.
6. Move the cursor to the next point in the route then press the **left-click** button. Repeat this step to enter all route points.
7. At the last route point, push the **RotoKey** to complete the route and save the route to the Routes list.

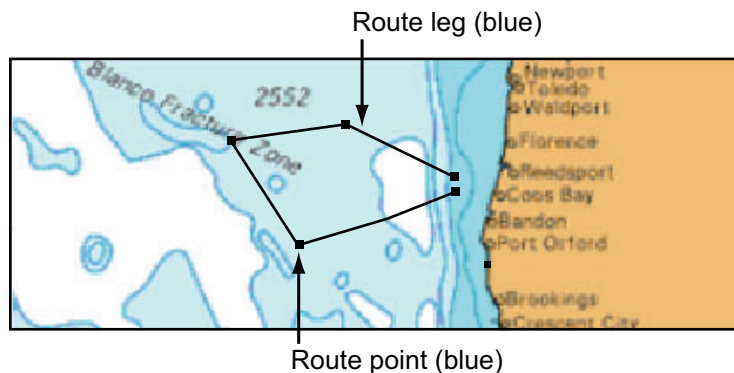

The route is saved to the Routes list under the youngest empty route number with "RTE" before the route number. A solid blue line runs between route points (blue squares).

5.2.2 How to Insert a Point on a Route

You can put a point between route legs when you need an additional point along a route.

1. Put the cursor on a leg of the route.
2. Push the **right-click** button to show the Routes pop-up menu.

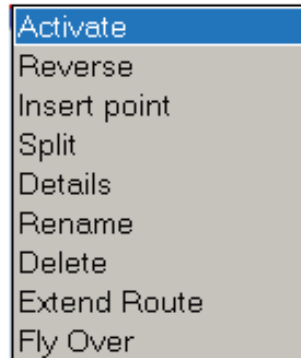

3. Use the **RotoKey** to select [Insert point]. A dashed line runs between the two points on the selected leg.



4. Move the cursor where to put a point then press the **left-click** button. A solid line replaces the dashed line.

5.2.3 How to Delete a Point

1. Place the cursor on the point to delete.
2. Push the **right-click** button to show the pop-up menu.
3. Use the RotoKey to select [Delete].

5. ROUTES

5.2.4 How to Extend a Route

You can extend a route from the last point on the route.

1. Place the cursor on a leg of the route.
2. Push the **right-click** button to show the pop-up menu.
3. Use the RotoKey to select [Extend Route]. A dashed line runs from the last point to the cursor.
4. Use the cursor to select a location then push the **left-click** button.
5. Repeat step 4 to enter more points, if necessary.
6. Push the **RotoKey** to finish.

5.2.5 How to Split a Route

You can divide a route in two to make two routes.

1. Put the cursor on the route leg where to divide the route.
2. **Right-click** to show the Routes pop-up menu.
3. Rotate the **RotoKey** to select [Split] then push the key.

When you divide a route, the new route is given the next route number. For example, you can divide route 001 (see below) to make a new route, route 002.

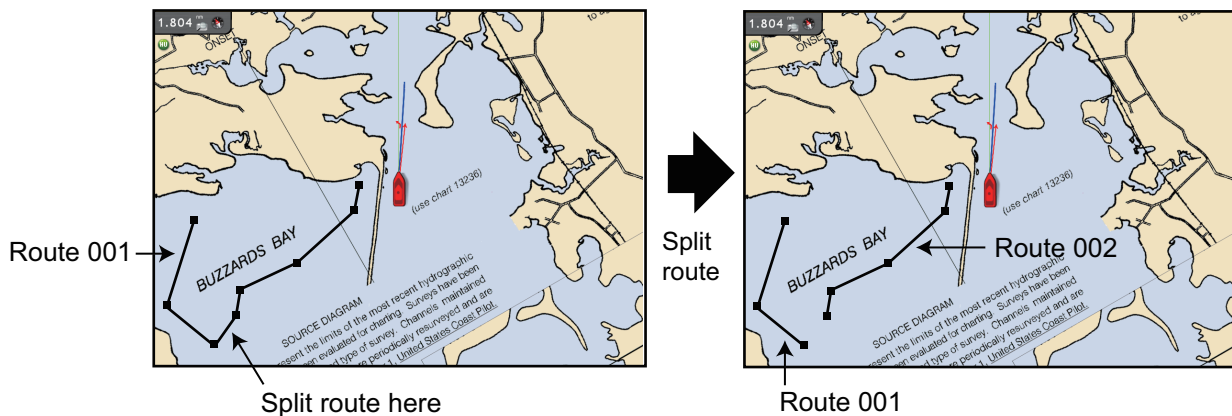

5.2.6 How to Join Two Routes

You can join two routes to create a new route. The new route takes the name of the 1st route selected and the 2nd route selected is deleted. All route data is updated.

How the routes are joined depends on route selection order. The last point of the 1st route selected is joined to the 1st point of the 2nd route selected. The example below shows how two routes are joined according to selection order.

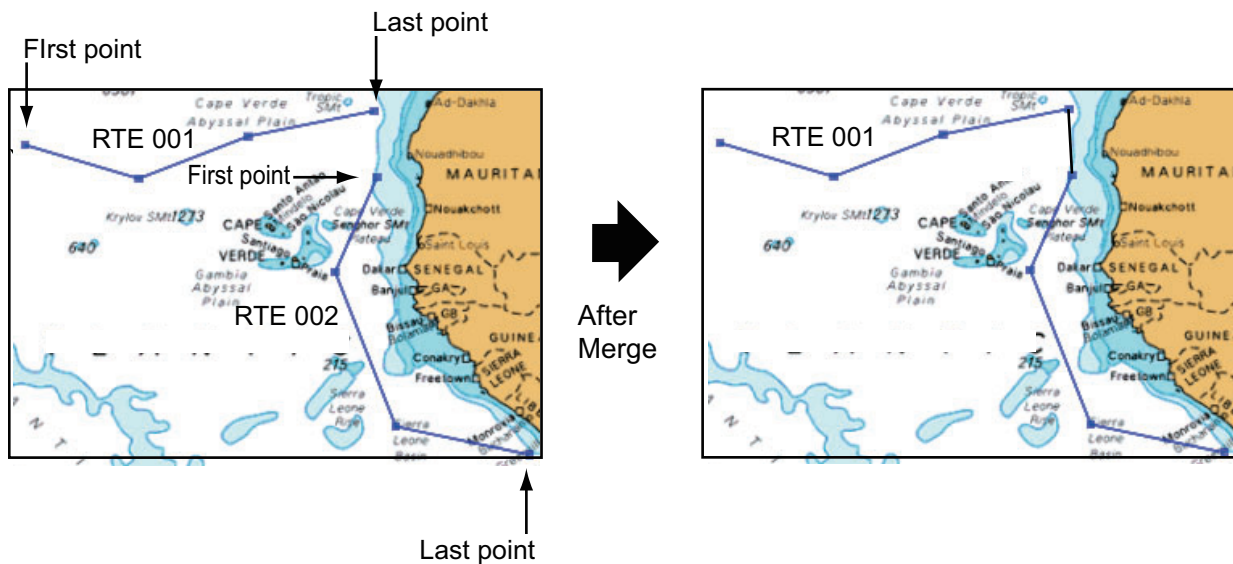

1. Press the **MENU** key to open the menu.
2. Select the [Routes-Routes] menu.
3. Use the **RotoKey** to select the 1st route. The Routes pop-up menu appears.



4. Use the **RotoKey** to select [Merge]. A small pop-up shows all saved routes, like the one below.

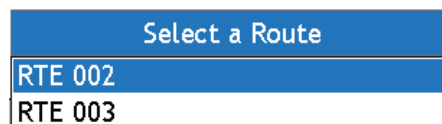

5. Use the **RotoKey** to select the 2nd route to join the two routes.
6. Press the **MENU** key to close the menu.

5.3 Routes List

The saved routes are stored in the Routes list. The list stores the following route data for each route:

- Name of route
- Length of route
- Number of route points
- Distance between legs and total distance
- Bearing between legs
- TTG between legs and total TTG

To show the routes list:

1. Press the **MENU** key to open the menu.
2. Open the [Routes] list.
3. Use the **RotoKey** to select the route to view.

Total = 4

Name	Length	Number...
RTE 011	340.2 nm	4
RTE 012	204 m	3
RTE 013	289 m	4
RTE 005	1569 nm	5

↑ Route name ↑ Route length ↑ No. of pts.

575.8 nm

Location of route

Name	Distance	Bearing	TTG
0 0	84.68 nm	52.9 °M	4h14m
1 1	99.08 nm	95.1 °M	4h57m
2 2	119.5 nm	128.3 °M	5h58m
3 3	191.7 nm	267.0 °M	9h35m
4 4	110.2 nm	347.0 °M	5h30m
Total	605.1 nm	285.6 °M	1d06h

- Name of point
- Dist. between points
- Bearing to point
- TTG to point

Exit Menu

The name of the route, the route's total length and its number of points are shown in the route box at the upper left 1/4 of the screen. The location of the route is shown on the map at the upper right 1/4 of the screen. The route information appears on the lower half of the screen.

4. Press the **MENU** key to close the menu.

5.4 How to Find Information About a Route on the Screen

Put the cursor on a route to get simple route information (name and length of route). Push the **left-click** button to get detailed information. This information includes name of route, length of route, no. of points, range and bearing to next point, and total time to go.

Name	RTE 001
Length	251.6 nm

Simple route information

Object Detail	
Name	RTE 001
Length	251.6 nm
Number of Pts	6
Range	3.104 nm
Bearing	173.5 °M
Tot route TTG	1d12h

Detailed route information

5.5 How to Find a Route on the Chart

You can easily find the location of a route if you select the route from the [Routes List]. The route selected is put at the center of the active chart plotter display.

1. Press the **MENU** key to open the menu then select the [Routes] tab in the [Routes] menu.
2. Use the **RotoKey** to select a route then push the key to show the Routes List pop-up menu.

Go To
Rename
Detail
Est Speed
Delete
Merge
Find/Edit on Chart

3. Use the **RotoKey** to select [Find/Edit on Chart].

5.6 How to Change the Name of a Route

The default route name is “RTE” plus the number of the youngest empty route number (RTE-001 - RTE-200). To change the name, follow the procedure shown below.

1. Press the **MENU** key to open the menu then select the [Routes] tab in the [Routes] menu.
2. Use the **RotoKey** to select a route. Push the key to show the Routes List pop-up menu.
3. Use the **RotoKey** to select [Rename] to show the [Rename] box.

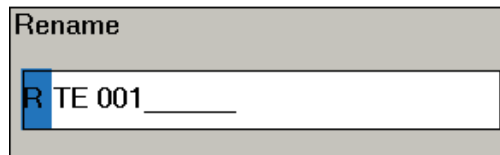

4. Use the **RotoKey** to enter a new name. Rotate the **RotoKey** to select a character then push the key to validate your selection.
5. Press the **MENU** key to close the menu.

5.7 How to Delete a Route

You can delete routes separately or together. An active route cannot be deleted.

5.7.1 How to Delete an Individual Route

CANCEL key

Put the cursor on the route to delete then press the **CANCEL** key.

Route list

Follow the procedure below to delete a route by using the Route list.

1. Press the **MENU** key to open the menu then select the [Routes] tab in the [Routes] menu.
2. Use the **RotoKey** to select the route then push the key to show the Routes List pop-up menu.
3. Use the **RotoKey** to select [Delete].
4. Press the **MENU** key to close the menu.

5.7.2 How to Delete All Routes

1. Press the **MENU** key to open the menu then select the [Routes] tab in the [Routes] menu.
2. Use the **RotoKey** to select the route then push the key to show the Routes List pop-up menu.
3. Use the **RotoKey** to select [Delete].
4. Press the **MENU** key to close the menu.

5.8 How to Show or Hide All Routes

All routes can be shown or hidden. An active route cannot be removed from the screen unless route following is stopped.

1. Long-push the **RotoKey** to show the soft controls.
2. Use the **RotoKey** to select [Routes].
3. Use the **RotoKey** to select [Show] then push the key to show or hide all routes.

5.9 How to Follow a Route

Before you follow a route, make sure that the path to the route is clear. Make sure to zoom your chart to check for hazards that do not appear on a smaller scale.

5.9.1 How to Follow an On-screen Route

1. Put the cursor on a leg of the route to follow then push the **right-click** button to show the Routes pop-up menu.
 2. Use the **RotoKey** to select [Activate].
- Note:** You can also activate a route by putting the cursor on the route then press the **GOTO/LIST** key.

When you select a route to follow, the following occurs.

- The color of all route legs changes from blue to red and a dashed line runs between the current position and 1st route point.
- The arrows on the route legs point in the direction to follow the route.

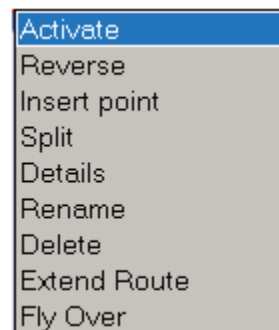

Arrow points in direction to follow route
Route leg (red line)

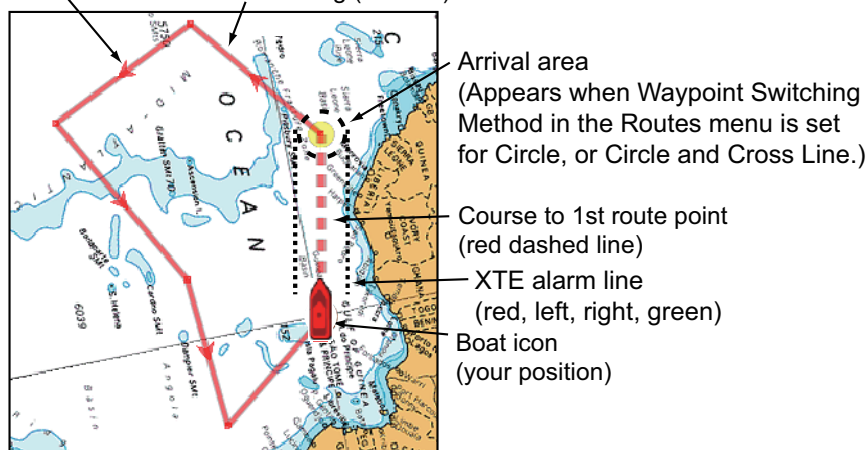

A red dashed line runs between current position and the point. This line is the course to follow to get to the point. The point arrival area is indicated with a circle, or both circle and line. You can select the arrival area indication method with [Waypoint Switching Mode] in the [Routes-General] menu. To receive an aural alarm when you are within a preset distance, turn on [Waypoint Notification] and set [Switching Circle Radius] on the [Routes-General] menu. The XTE alarm lines, red for port side, green for starboard side, show the XTE alarm range. You can show or hide these lines with [XTE Alarm Lines] in the [Routes-General] menu.

5.9.2 How to Follow a Route Selected from the Routes List

1. Press the **MENU** key to open the menu.
2. Open the [Routes-Routes] menu.
3. Use the **RotoKey** to select a route then push the key to show the Routes pop-up menu.

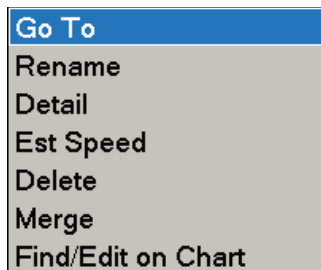

4. [Go To] is selected. Push the **RotoKey**.

A red dashed line runs between current position and the point. This line is the course to follow to get to the point. The point arrival area is indicated with a circle, or both circle and line. You can select the arrival area indication method with [Waypoint Switching Mode] in the [Routes-General] menu. To receive an aural alarm when you are within a preset distance, turn on [Waypoint Notification] and set [Switching Circle Radius] on the [Routes-General] menu. The XTE alarm lines, red for port side, green for starboard side, show the XTE alarm range. You can show or hide these lines with [XTE Alarm Lines] in the [Routes-General] menu.

5.9.3 How to Start Navigation from a Point

1. Place the cursor on the point of the route from where to start navigation.
2. Push the **right-click** button to show the pop-up menu.

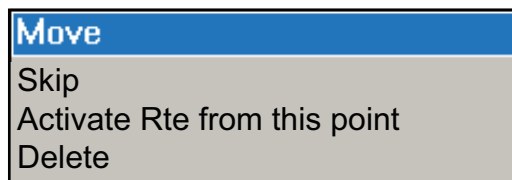

3. Select [Activate Rte from this Point] and push the **RotoKey**.

A red line runs between current position and the point. This line is the course to follow to get to the point. The point arrival area is indicated with a circle, or both circle and line. You can select the arrival area indication method with [Waypoint Switching Mode] in the [Routes-General] menu. To receive an aural alarm when you are within a preset distance, turn on [Waypoint Notification] and set [Switching Circle Radius] on the [Routes-General] menu. The XTE alarm lines, red for port side, green for starboard side, show the XTE alarm range. You can show or hide these lines with [XTE Alarm Lines] in the [Routes-General] menu.

5.9.4 How to Show Information About a Route

1. Put the cursor on a route leg of the active route then push the **right-click** button to show the Routes pop-up menu.
2. Use the **RotoKey** to select [Route Info].

The display shows route information for the route selected.

- Each route point name
- Distances between points
- Bearings between points
- Time-to-go between points
- Total distance
- Bearing from the first to the last route points
- Total time-to-go

Name	Distance	Bearing	TTG
0 0	84.80 nm	52.9 °M	4h14m
1 1	99.08 nm	95.1 °M	4h57m
2 2	119.5 nm	128.3 °M	5h58m
3 3	191.7 nm	267.0 °M	9h35m
4 4	110.2 nm	347.0 °M	5h30m
Total	605.3 nm	285.6 °M	1d06h

5.9.5 Flyover

The flyover feature lets you view an entire route from overhead, with the screen automatically scrolled as the flyover progresses. Select the route, push the **right-click** button to show the Routes pop-up menu and the choose [Flyover].

5.10 Operations When You Follow a Route

5.10.1 Restart Navigation

When you follow a route, you can restart the navigation to the next point on the route from current location.

When you steer to keep away from an obstruction or the vessel drifts, you go off course as shown in Line 1 in the figure. If you do not need to return to the original course, you can go to the point from the current position as shown in Line 2 in the figure.

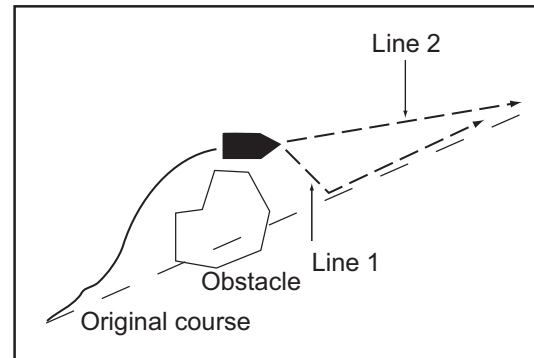

1. Use the CursorPad to put the cursor on the dashed line of the route.
2. Push the **right-click** button to show the Route Follow pop-up menu.

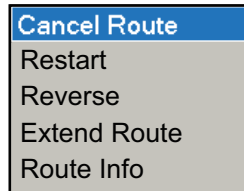

3. Use the **RotoKey** to select [Restart].
The route start position for the route moves to the current position and the XTE becomes zero.

5.10.2 Follow a Route in the Reverse Direction

You can follow a route in reverse order. This helps you return along the same path.

1. Use the CursorPad to put the cursor on the dashed line of the route.
2. Push the **right-click** button to show the Route Follow pop-up menu.

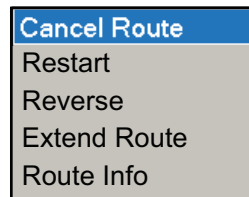

3. Use the **RotoKey** to select [Reverse].
The arrows on the route point in reverse direction.

5.10.3 Stop Following a Route

1. Use the CursorPad to put the cursor on the dashed line of the route.
2. Push the **right-click** button to show the Route Follow pop-up menu.

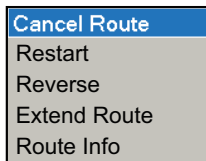

3. Use the **RotoKey** to select [Cancel Route].

The arrival area, XTE alarm lines and set course are erased from the screen. The red lines turn blue.

5.10.4 Skip a Leg on a Route

There are times when you do not need to follow all legs in an active route. You can skip a leg as shown in the procedure below. After you select the point to skip, the route is re-drawn, with that point removed.

1. Put the cursor on the route point to skip.
2. Push the **right-click** button to show the Routes pop-up menu.
3. Use the **RotoKey** to select [Skip].

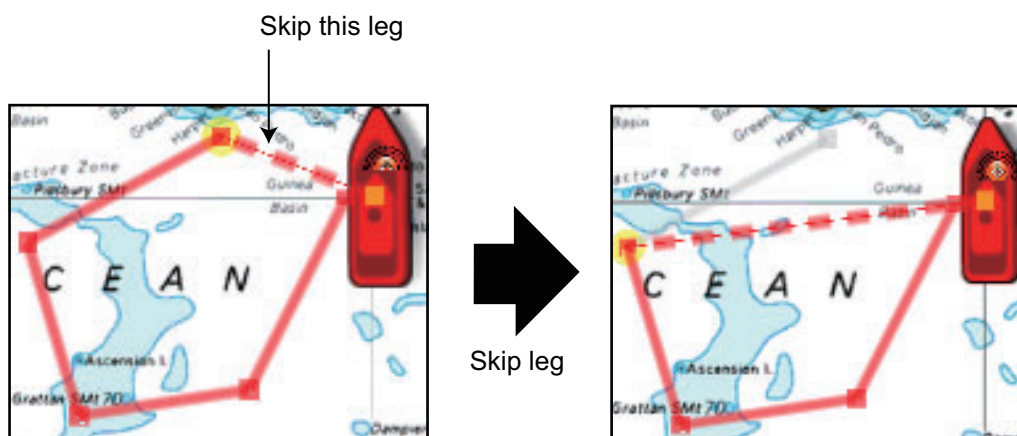

5.10.5 Waypoint Switching Mode

When you reach a route point, your unit automatically changes to the next route point according to the waypoint switching mode selected on the menu.

Cross Line: Change the waypoint when the vessel moves through an imaginary cross line (vertical line) that moves through the center of the destination point.

Circle: Change the waypoint when the vessel comes within the circle.

Cross Line & Circle: Change the waypoint when one of the above two conditions is met.

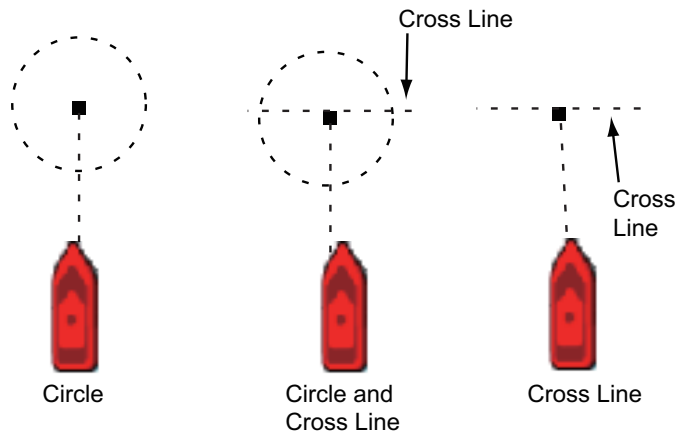

1. Press the **MENU** key to open the menu.
2. Open the [Routes-General] menu.
3. Use the **RotoKey** to select [Waypoint Switching Mode].

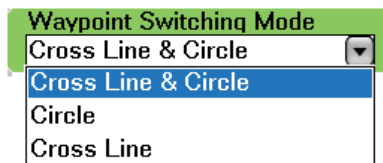

4. Use the **RotoKey** to select an option.
5. Use the **RotoKey** to select [Switching Mode Circle Radius].
6. Use the **RotoKey** to enter the distance from a route point at which to change to next point.
7. Press the **MENU** key to close the menu.

5.10.6 Route Auto Zoom

You can get automatic range change after you have moved past a route point. Use this feature to find the next point in a route when the point is not within the current display range.

1. Press the **MENU** key to open the menu.
2. Open the [Routes-General] menu.
3. Use the **RotoKey** to select [Route Auto Zoom] then push the key to activate or deactivate the zoom.
4. Press the **MENU** key to close the menu.

5.10.7 XTE Alarm Lines

The XTE alarm lines mark the XTE alarm range set on the [Alarm] menu. You can show or hide these lines.

1. Press the **MENU** key to open the menu.
2. Open the [Routes-General] menu.
3. Use the **RotoKey** to select [Display XTE Alarm Lines] then push the key to show or hide the lines.
4. Press the **MENU** key to close the menu.

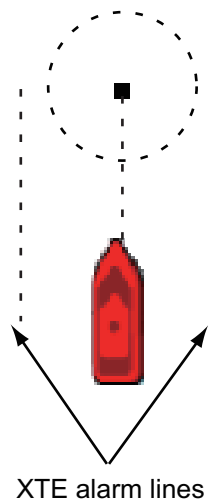

5.10.8 Waypoint Arrival Notification

The waypoint notification feature releases audio and visual alarms when you are near a route point by some distance. You set the distance with [Switching Mode Circle Radius] on the [Routes] menu. Activate or deactivate this feature as follows.

1. Press the **MENU** key to open the menu.
2. Open the [Routes-General] menu.
3. Use the **RotoKey** to select [Waypoint Notification] then push the key to activate or deactivate this feature.
4. Press the **MENU** key to close the menu.

When you near a route point, the buzzer sounds and the message "Switching to next waypoint." appears in the status bar. The message is erased after your vessel goes by the point. You can stop the buzzer with the **CANCEL** key.

5.11 Navigation Calculator

The navigation calculator helps you plan navigation (by speed). Enter a speed then the calculator calculates the TTG between legs and the total TTG.

1. Press the **MENU** key to open the menu.
2. Open the [Routes list] on the [Routes] menu.
3. Use the **RotoKey** both to select a route then push the key to show the Routes List pop-up menu.

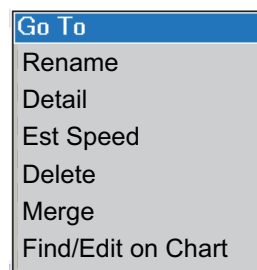

4. Use the **RotoKey** to select [Est Speed].

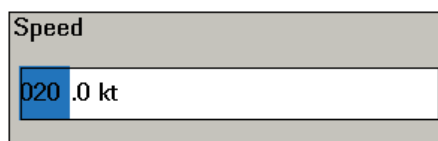

5. Rotate the **RotoKey** to select a value then push the key to set the value.
6. Press the **MENU** key to close the menu.

The results of the calculation appear at the bottom of the display.

6. RADAR

This chapter provides the information necessary for radar operation. The topics include how to do the following.

- Adjust the gain
- Reduce sea and rain clutter
- Measure the range and bearing to a target
- Reduce radar interference
- Expand echoes
- Set a guard zone
- Understand the radar display

Your radar can be tuned automatically or manually, and automatic is the default method. For manual tuning, see paragraph 13.5.3.

6.1 How to Transmit, Set the Radar in Stand-by

When the power switch is turned on, the radar begins to warm the magnetron. The magnetron is the device in the antenna unit which transmits the radar pulses. The radar takes approximately 1:30 (3:00 for DRS25A) to warm the magnetron. The timer at the center of the display shows the time left. When the countdown reaches zero (0:00), "Standby" appears at the center of the screen, which indicates the radar can now transmit pulses. Long-push the **GAIN/TX** key to transmit. You can also use the Tx soft control and Tx in the Radar pop-up menu.)

If you do not require the radar for some time, set the radar in stand-by to save the magnetron from unnecessary use. Long-push the **GAIN/TX** key to switch between transmit and stand-by.

6.2 How to Adjust the Gain

The **GAIN/TX** key adjusts the gain (sensitivity) of the radar receiver. This key operates like the volume control of a broadcast receiver, which amplifies received signals.

The correct setting shows some background noise on the screen. If you do not use enough gain, weak echoes are erased. If you use more gain than necessary, the background noise hides both weak and strong targets.

Automatic gain adjustment

1. Press the **GAIN/TX** key to show the Gain-Sea-Rain adjustment window. (You can also show the window if you put the cursor near the site of the window.)



2. [Gain] is selected. Rotate the **RotoKey** to the left until "Auto" appears in the bar. The Gain "A" icon is green when the automatic gain is active.

Note: The Gain-Sea-Rain pop-up allows you to switch between automatic and manual gain adjustment as shown in the procedure which follows.

1. Show the Gain-Sea-Rain adjustment window.
2. Push the **right-click** button to show the Gain-Sea-Rain pop-up menu.

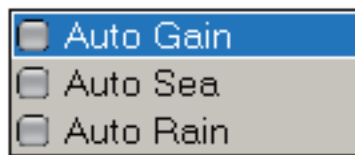

3. Rotate the **RotoKey** to select [Auto Gain] then push the key to activate or deactivate the Auto Gain.

Manual gain adjustment

1. Press the **GAIN/TX** key to show the Gain-Sea-Rain adjustment window. (You can also show the window if you put the cursor near the site of the window.)
2. [Gain] is selected. Rotate the **RotoKey** to adjust the gain level. The length of the bar increases or decreases when you rotate the key.
3. Push the **RotoKey** to validate the setting and close the window.

6.3 How to Reduce Sea Clutter

The reflected echoes from waves appear at the central part of the display and have the name "sea clutter". The sea clutter increases in width as the height of waves and the height of the antenna above the water increase. If the sea clutter is strong, targets can be hidden inside the clutter, like in the left-hand figure shown below.

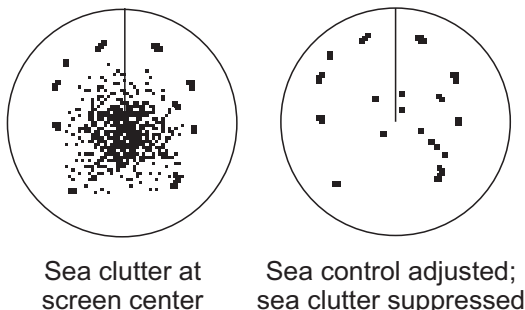

When the sea clutter hides targets, adjust the Sea control (automatically or manually) to reduce the clutter. After the sea clutter is gone, turn off the Sea control to prevent the loss of targets.

There are two methods of sea clutter suppression; Advanced and Coastal. Advanced provides for standard suppression of sea clutter and is intended for normal use. When you are cruising along a coastline with Advanced, if Advanced does not reduce sea clutter very well, use Coastal. To use Coastal, long-push the **RotoKey** to select [Auto Sea] followed by [Advanced] or [Coastal].

Automatic sea clutter adjustment

1. Press the **GAIN/TX** key to show the Gain-Sea-Rain adjustment window. (You can also show the window if you put the cursor near the site of the window.)



2. Press the **GAIN/TX** key again to select [Sea].

The Sea "A" icon is green when the automatic Sea is active.

Note: The Gain-Sea-Rain pop-up allows you to switch between automatic and manual sea clutter adjustment as shown in the procedure which follows.

1. Show the Gain-Sea-Rain adjustment window.
2. Push the **right-click** button to show the Gain-Sea-Rain pop-up menu.

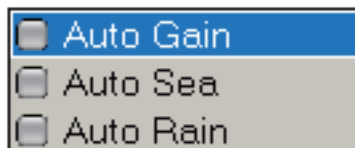

3. Rotate the **RotoKey** to select [Auto Sea] then push the key to activate or deactivate the Auto Sea.

Manual sea clutter adjustment

1. Press the **GAIN/TX** key to show the Gain-Sea-Rain adjustment window. (You can also show the window if you put the cursor near the site of the window.)
2. Press the **GAIN/TX** key again to select [Sea].
3. Rotate the **RotoKey** to adjust the sea clutter level.
4. Push the **RotoKey** to validate the setting and close the window.

6.4 How to Reduce Rain Clutter

When your vessel is in or near rain or snow, the reflections from the rain or snow appear on the screen. These reflections have the name “rain clutter.” When the rain clutter is strong, targets in or near the rain clutter are hidden in the clutter. Reflections from the rain clutter are easily identified from true targets by their wool-like appearance.

The Rain control breaks the continuous display of rain or snow reflections into a random pattern. The Rain control also helps to reduce the target clutter in good weather in busy harbors.

When the rain clutter hides targets, adjust the Rain control (automatic or manual) to reduce the clutter. After the rain clutter is gone, turn off the Rain control to prevent the loss of targets.

Automatic rain clutter adjustment

1. Press the **GAIN/TX** key to show the Gain-Sea-Rain adjustment window. (You can also show the window if you put the cursor near the site of the window.)



2. Press the **GAIN/TX** key again to select [Rain].
3. Rotate the **RotoKey** to adjust the rain clutter level.
4. Push the **RotoKey** to validate the setting and close the window.

The Rain "A" icon is green when the automatic rain is active.

Note: The Gain-Sea-Rain pop-up allows you to switch between automatic and manual rain clutter adjustment.

1. Show the Gain-Sea-Rain adjustment window.
2. Push the **right-click** button to show the Gain-Sea-Rain pop-up menu.

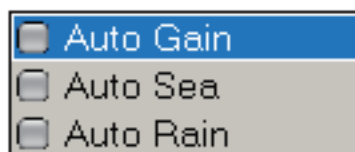

3. Rotate the **RotoKey** to select [Auto Rain] then push the key to activate or deactivate the Auto Rain.

Manual rain clutter adjustment

1. Press the **GAIN/TX** key to show the Gain-Sea-Rain adjustment window. (You can also show the window if you put the cursor near the site of the window.)
2. Press the **GAIN/TX** key again to select [Rain].
3. Rotate the **RotoKey** to adjust the rain clutter level.
4. Push the **RotoKey** to validate the setting and close the window.

6.5 Range Scale

The range setting controls the size of the area (in nautical miles, kilometers or statute miles) that appears on your display. The range ring interval is set automatically according to the range scale. This automatic selection allows for accurate range measurements on any range setting. The range and range ring interval appear at the top left-hand corner of the display.

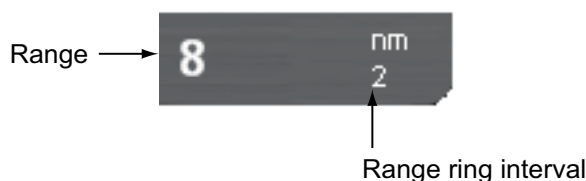

There are three methods to select a range scale:

- **RANGE key:** Hit **RANGE OUT** to increase the range, or **RANGE IN** to decrease the range.
- **Left-click button:** Put the cursor on the range indication. Push the **left-click** button, and the range box turns green. Rotate the **RotoKey** to select a range then push the key to validate your selection.
- **Right-click button:** Put the cursor on the range indication. Push the **right-click** button to show the Range pop-up menu, shown below. Rotate the **RotoKey** to select a range then push the key to validate your selection.

Note: If the software version for the DRS2D/4D/4A/6A/12A/25A is 0359235-01.19 or higher, you cannot use [120 nm].

0.0625 nm
0.125 nm
0.25 nm
0.5 nm
0.75 nm
1 nm
1.5 nm
2 nm
3 nm
4 nm
6 nm
8 nm
12 nm
16 nm
24 nm
32 nm
36 nm
48 nm
64 nm
72 nm
96 nm
120 nm

6.6 Orientation Mode

The orientation mode controls the relationship between your vessel and all the other targets.

The heading data is required in modes except the head-up mode. When the heading data is lost, the orientation mode automatically goes to head-up. A red "X" is also put on the compass icon on the status bar. Restore the compass signal to show the heading indication. Select the orientation mode again if necessary.

To select an orientation mode, use the **RotoKey** to select Head Up, Course Up or North Up. (You can also select an orientation mode with the orientation mode icon (top-left corner) and the Radar pop-up menu.)

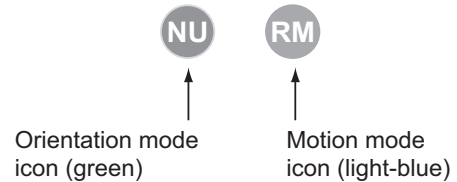

To select a motion mode, click the motion mode icon with the **left-click** button.

6.6.1 Description of Orientation Modes

Relative motion displays

The relative motion display is fixed. The movement of all targets is shown with reference to your vessel, which is normally at the center of the screen.

Head-up

A display without azimuth stabilization in which the line that connects the center with the top of the display indicates your heading. Targets are shown at their measured distances and in their directions relative to your heading. The arrow on the bearing scale is the north marker.

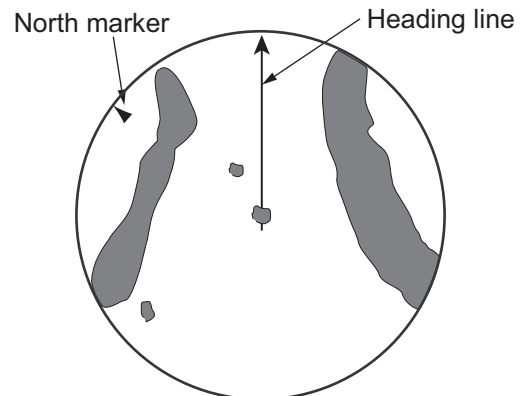

Course-up

The radar picture is stabilized and displayed with the currently selected course at the top of the screen. When you change the heading, the heading line moves with the course selected. If you select a new course, the picture resets to display the new course at the top of the display.

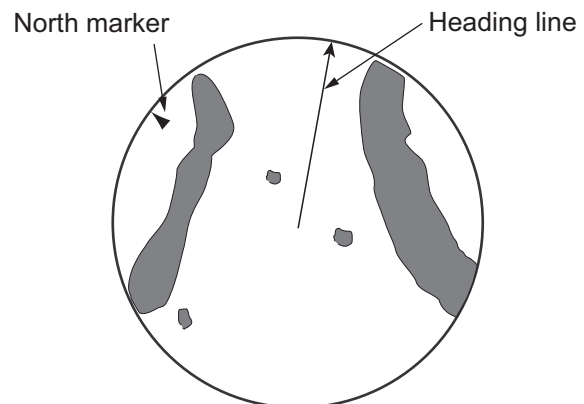

Targets are shown at their measured distances and their directions relative to the set course, which is at the 0-degree position. The heading line moves according to the yawing and any course change.

North-up

Targets are shown at their measured distances and their true (compass) directions from your vessel. North is at the top of the screen. The heading line changes its direction according to your heading.

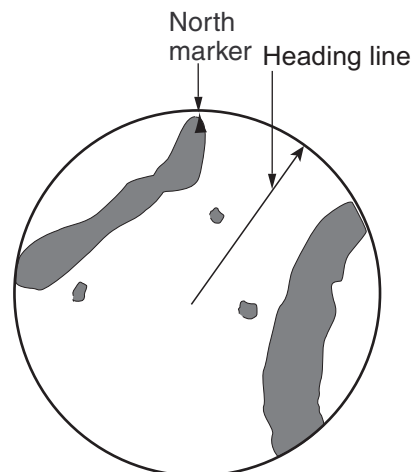

True motion display

Your vessel and vessels in motion move across the radar image at their correct speeds and positions (L/L). When your vessel gets near the edge of the screen, the vessel is automatically returned to the center of the screen. You can manually return your position to the center of the screen if you press the **SHIP/3D** button.

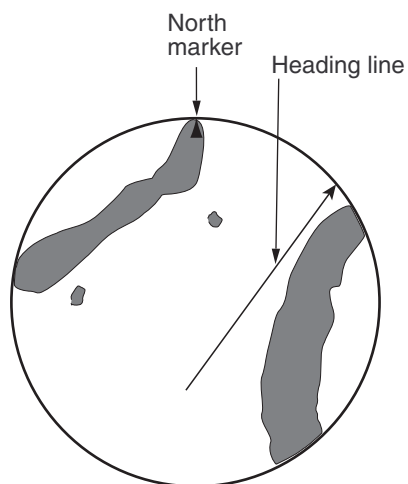

6.7 How to Measure the Range to a Target

You can measure the range to a target three methods:

- By the range rings
- By the cursor (see section 1.10)
- By the Variable Range Marker (VRM)

Use the fixed range rings to get a rough estimate of the range to a target. These rings are the concentric solid circles about your vessel. The number of rings is automatically controlled by the selected range scale. The interval is displayed at the upper-left position of the screen. To measure the range with the range rings, count the number of rings between the center of the display and the target. Check the range ring interval and estimate the distance of the echo from the inner edge of the nearest ring.

6.7.1 How to Display the Range Rings

If the rings are not displayed, push the **right-click** button to show the Radar pop-up menu. Use the **RotoKey** to select [Rings] then push the key to show or hide the range rings.

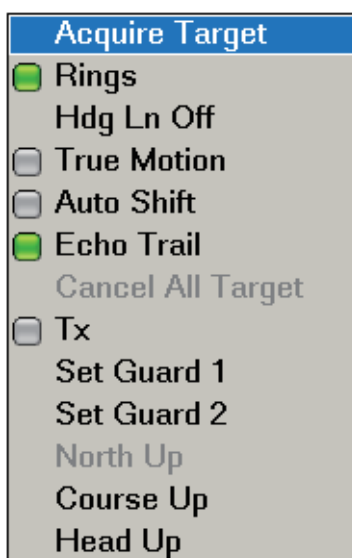

6.7.2 How to Measure the Range with a VRM

There are two VRMs, No. 1 and No. 2. The VRMs are dashed rings so that you can identify the rings from the fixed range rings. The length of the dashes on each VRM is different so that you can identify the rings. The dashes of the No. 1 VRM are shorter than those of the No. 2 VRM.

To measure the range to a target with a VRM:

1. Push the **RotoKey** to show the soft controls. (In the default arrangement, a short-push activates VRM1 and a long-push activates VRM1 and VRM2.)
2. Use the **RotoKey** to select VRM followed by VRM1 or VRM2 to show the VRM box. The indication of the selected VRM is shown in green in the box.
3. Rotate the **RotoKey** (or use the CursorPad) to put the VRM on the inner edge of the target. Read the range to the target at the VRM box. Distances shorter than 0.500 nm are shown in yards (default arrangement).

4. Push the **RotoKey** to finish. The VRM is then fixed at the range selected.

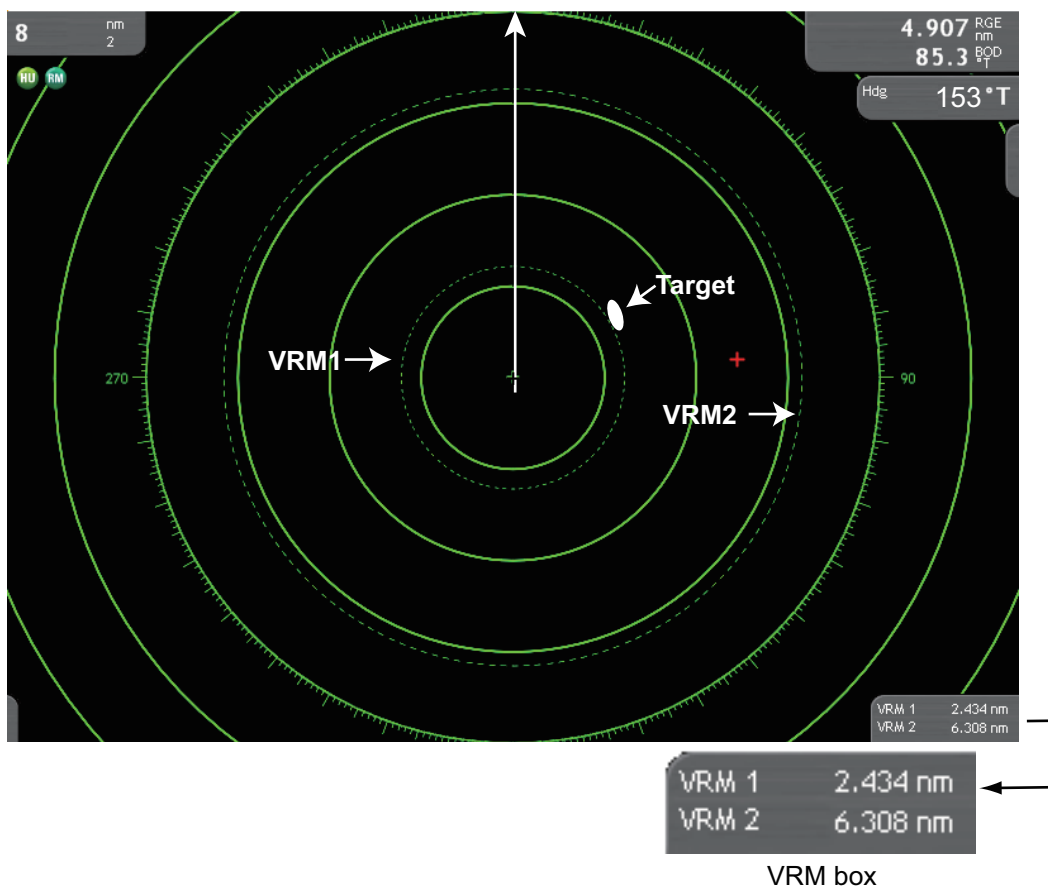

6.7.3 How to Deactivate a VRM

1. Push the **RotoKey** to show the soft controls. (In the default arrangement, a short-push activates VRM1 and a long-push activates VRM1 and VRM2.)
2. Select [VRM] and [Clear 1] or [Clear 2].

The selected VRM and the related VRM indication are erased.

You can also erase a VRM with the EBL/VRM pop-up menu. Put the cursor in the VRM box then push the **right-click** button to show the EBL/VRM pop-up menu. Rotate the **RotoKey** to select the VRM then push the key to erase.

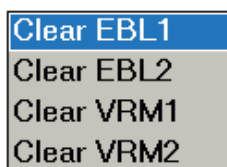

6.8 How to Measure the Bearing to a Target

The Electronic Bearing Line (EBL) measures the bearing to targets.

6.8.1 How to Measure the Bearing with an EBL

There are two EBLs, No. 1 and No. 2. Each EBL is a straight dashed line from the center of the screen to the edge. The dashes of the No. 1 EBL are shorter than those of the No. 2 EBL.

To measure the bearing to a target with an EBL:

1. Push the **RotoKey** to show the soft controls. (In the default arrangement, a short-push activates EBL1 and a long-push activates EBL1 and EBL2.)
2. Select EBL followed by EBL1 or EBL2 to show the EBL box. The indication of the selected EBL is shown in green in the box.
3. Rotate the **RotoKey** (or use the CursorPad) to divide the target with the EBL. Read the bearing to the target at the EBL box.
4. Push the **RotoKey** to finish. The EBL is then fixed at the bearing selected.

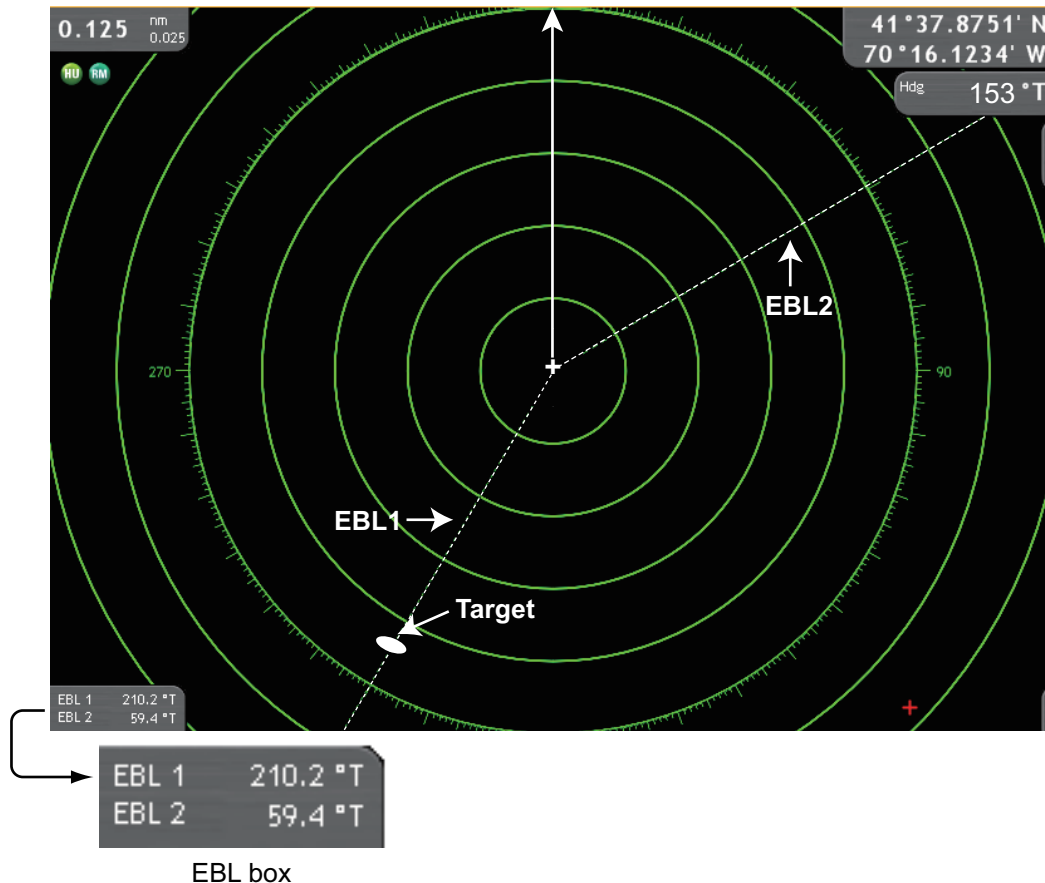

6.8.2 How to Erase an EBL

1. Push the **RotoKey** to show the soft controls. (In the default arrangement, a short-push activates EBL1 and a long-push activates EBL1 and EBL2.)
2. Select [EBL] and [Clear1] or [Clear2].

The selected EBL and the related EBL indication are erased.

You can also erase an EBL with the EBL/VRM pop-up menu. Put the cursor in the EBL box then push the **right-click** button to show the EBL/VRM pop-up menu. Rotate the **RotoKey** to select the EBL then push the key to erase.

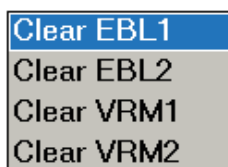

6.8.3 How to Select True or Relative Bearing

A "T" (true) follows the EBL indication if the bearing is in reference to the north, or "M" when [Bearing Display] in the [Global-General] menu is set for [Magnetic]. (There is no indication for relative bearing.) You can select relative or true bearing indication in the head-up mode as follows:

1. Press the **MENU** key to open the menu.
2. Open the [Radar] menu.
3. Use the RotoKey to select [EBL Reference].

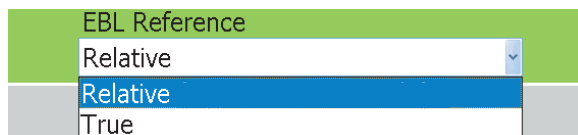

4. Use the RotoKey to select [Relative] or [True].
5. Press the **MENU** key to close the menu.

6.9 How to Off-center the Picture

You can off-center your position to expand the view field without selecting a larger range scale. The position can be off-centered in the bow, stern, port or starboard direction, but not more than 75% of the range in use.

To off-center the radar picture, operate the ScrollingPad. To return your vessel to the center of the screen, press the **SHIP/3D** button.

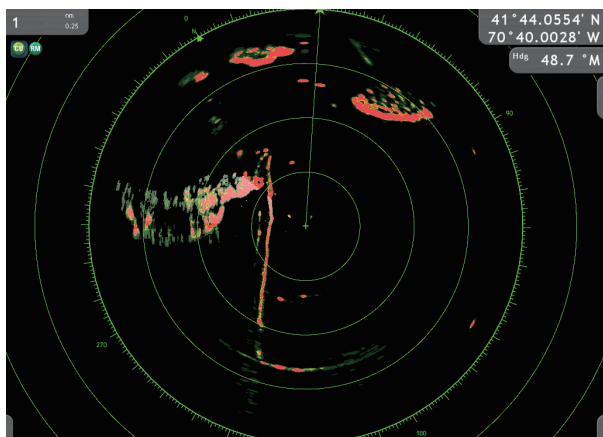

Normal picture

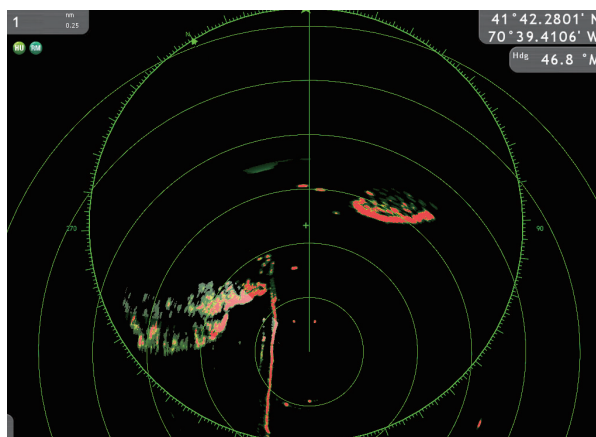

Picture off-centered in stern direction

6.10 Heading Line

The heading line indicates your heading in all orientation modes. This line connects between your position to the outer edge of the radar display. The line is at zero degrees on the bearing scale in the head-up mode. The orientation of the line changes in the north-up, course-up and true motion modes with the movement of your vessel.

To show or hide the heading line:

1. Put the cursor where there is no symbol then push the **right-click** button. The Radar pop-up menu appears.

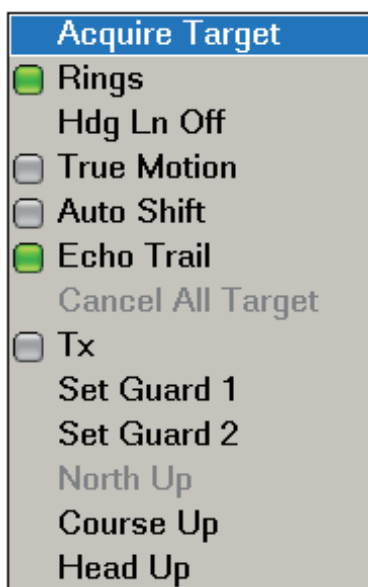

2. Use the **RotoKey** to select [Hdg Ln Off] then push the key to hide the heading line. The heading line remains hidden until you release the key.

6.11 How to Reduce Radar Interference

Radar interference can occur when your vessel is near the radar of another vessel that operates on the same frequency band with your radar. The interference shows on the screen in many bright dots. The dots can be random or in the shape of dotted lines that run from the center to the edge of the display. You can identify the interference from the normal echoes, because the interference does not appear in the same location at the next rotation of the antenna.

Turn off the interference rejector when there is no interference to prevent the loss of weak targets.

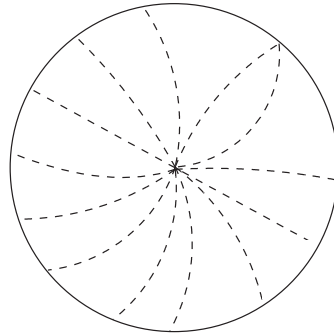

To use the interference rejector

1. Long-push the **RotoKey**.
2. Use the **RotoKey** to select [Filters] followed by [Int Reject].
3. Push the **RotoKey** to activate or deactivate the interference rejector.

6.12 Guard Alarm

The purpose of the guard alarm is to provide audio and visual warnings against targets (vessels, islands, landmasses, etc.) when a radar target enters the area you select.

6.12.1 How to Set a Guard Zone

You can set a guard zone by two methods. Use the Radar pop-up menu or the soft controls ([Guard Zone]→[Zone] 1(2)). The procedure shown below shows how to set a zone with the pop-up menu.

1. Push the **right-click** button to show the Radar pop-up menu.

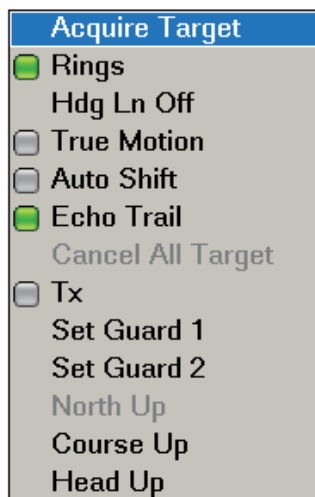

2. Use the **RotoKey** to select [Set Guard 1] or [Set Guard 2].
3. Use the CursorPad to put the cursor at point A for the guard zone then push the **left-click** button.
4. Use the CursorPad to move the cursor to point B for the guard zone then push the **left-click** button.



Note 1: To set a 360-degree guard zone, set the same bearing for both the position A and position B.

Note 2: The location of points A and B control the shape of the guard zone. Below are three examples.

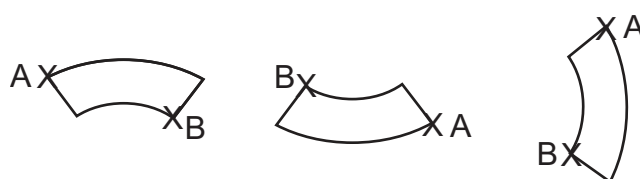

6.12.2 How to Activate or Deactivate a Guard Zone

Put the cursor on a line of the guard zone. Push the **right-click** button to show the Guard Alarm pop-up menu. Use the **RotoKey** to activate or deactivate the alarm.

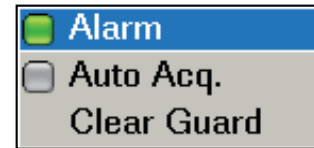

If a target enters the zone, the buzzer sounds and the message "Target enters Guard Zone 1 (or 2), Press Menu Button." appears in the text area. The audio alarm stops when you press the **CANCEL** key or **MENU** key. The visual alarm continues until the target leaves the guard zone or the guard alarm is deactivated or cancelled.

6.12.3 How to Erase a Guard Zone

1. Put the cursor on a line of the guard zone. Push the **right-click** button to show the Guard Alarm pop-up menu.
2. Use the **RotoKey** to select [Clear Guard] then push the key to erase the guard zone from the screen.

You can also use the soft controls to erase a guard zone - [Guard Zone]→[Clear] 1(2)).

6.13 Watchman

The watchman function transmits every 5, 10 or 20 minutes (selectable on menu) for one minute to check for targets in a guard zone. If a target is found in the zone, the watchman is cancelled and the radar continues to transmit. If there are no targets in the zone, the radar goes into stand-by for the number of minutes set on the menu. This feature helps you watch for targets in the area you set when you do not continuously require the radar.

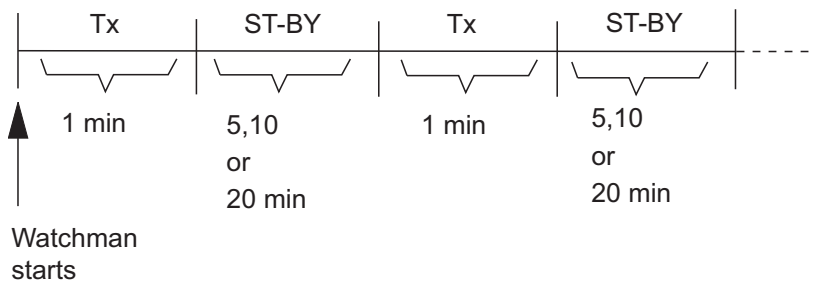

1. Set a guard zone. See paragraph 6.12.1 "How to Set a Guard Zone". (Watchman does not operate unless a guard zone is active. You can set Watchman when the radar is in transmit state.)
2. Press the **MENU** key to open the menu.
3. Open the [Radar-General] menu.
4. Use the **RotoKey** to select [Watchman] and set watchman rest interval.
5. Press the **MENU** key to close the menu.

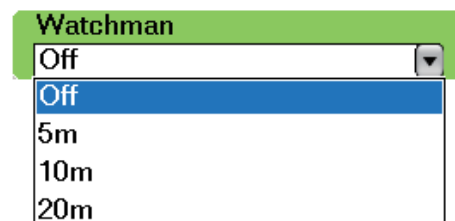

To cancel Watchman, select [Off] at step 4 in this procedure, or set the radar in transmit or stand-by.

6.14 Echo Trails

Echo trails show the movements of radar targets relative or true to your vessel in imitation afterglow. This function helps alert you to possible collision conditions.



(a) True target trails
(No smearing of
stationary targets)

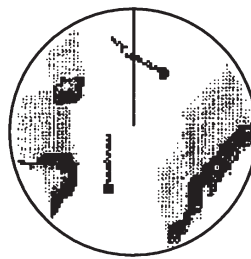

(b) Relative target trails
Targets moving relative
to own ship

6.14.1 How to Hide or Show Echo Trails

Long-push the **RotoKey** to show the soft controls. Use the **RotoKey** to select [Echo Trail] then push the key to hide or show trails.

6.14.2 How to Clear Echo Trails to Start New Trails

Use the **RotoKey** to select [Clr Trail] to clear trails and restart with new trails. Trails are restarted when the range or trail reference is changed.

6.14.3 Echo Trail Time

Set the trail time on the [Radar] menu. Trails are shown on the display until the end of the selected trail time then the trails are erased and restarted.

1. Press the **MENU** key to open the menu.
2. Open the [Radar-General] menu.
3. Use the **RotoKey** to select [Echo Trail Time] and set time interval.

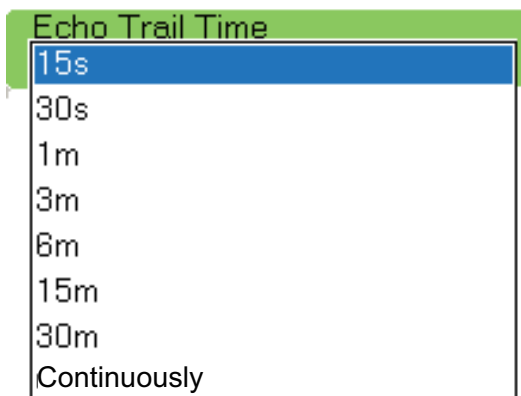

4. Press the **MENU** key to close the menu.

6.14.4 Echo Trail Reference

Trail movement can be set for relative or true. The relative trails show the relative movements between targets and your vessel. True motion trails show the movements of targets according to the targets over-the-ground speeds and courses. True trails require position and heading information.

1. Press the **MENU** key to open the menu.
2. Open the [Radar-General] menu.
3. Use the **RotoKey** to select [Echo Trails] and trail reference.
4. Press the **MENU** key to close the menu.

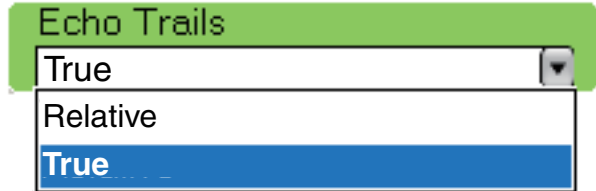

6.14.5 Echo Trail Color

Trail color can be selected to blue, yellow or green.

1. Press the **MENU** key to open the menu.
2. Open the [Radar-General] menu.
3. Use the **RotoKey** to select [Echo Trail Color] and color.
4. Press the **MENU** key to close the menu.

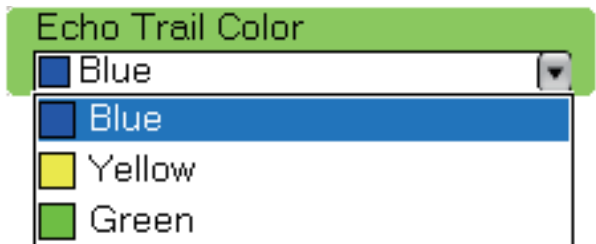

6.14.6 Echo Trail Style

The echo trail can be shown in gradual shading or single shade, like in the figure shown below.

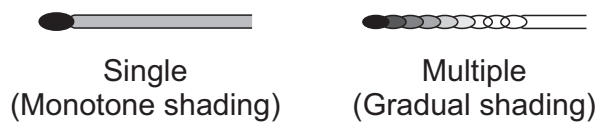

1. Press the **MENU** key to open the menu.
2. Open the [Radar-General] menu.
3. Use the **RotoKey** to select [Echo Trail Style] and multi color or single color.

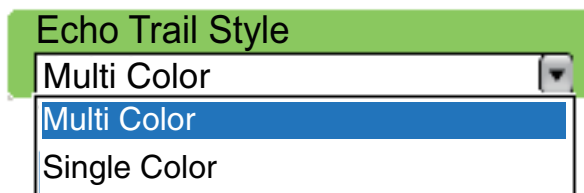

4. Press the **MENU** key to close the menu.

6.15 Echo Stretch

The radar adjusts the reflected echoes from long-range targets, but the echoes are normally displayed weak and small. If you have a weak, long-range target that requires closer inspection, use the echo stretch to magnify the target.

This function magnifies the targets and sea clutter and radar interference. For this reason, correctly adjust the sea clutter and radar interference before you activate the echo stretch.

To activate or deactivate the echo stretch:

1. Long-push the **RotoKey**.
2. Use the **RotoKey** to select [Filters].
3. Use the **RotoKey** to select [Stretch] then push the key to activate or deactivate the echo stretch.

6.16 Echo Average

The echo average feature effectively suppresses sea clutter. Echoes received from stable targets such as ships appear on the screen at almost the same position during every rotation of the antenna. On the other hand, unstable echoes such as sea clutter appear at random positions.

To distinguish real target echoes from sea clutter, echo average performs scan-to-scan correlation. Correlation is made by storing and averaging echo signals over successive picture frames. If an echo is solid and stable, it is presented in its normal intensity. Sea clutter is averaged over successive scans resulting in the reduced brilliance, making it easier to discriminate real targets from sea clutter.

To properly use the echo average function, first suppress sea clutter with the A/C SEA control. Then, with the full RotoKey set active, use the **RotoKey** to select [Filters] followed by [Average].

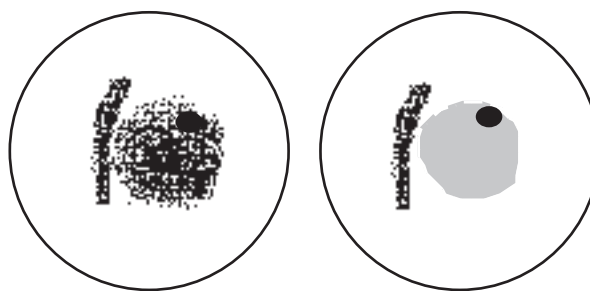

(a) Echo average OFF

(b) Echo average ON

6.17 Automatic Shift

The position of your vessel, or sweep origin, can be automatically moved to expand the view field without selecting a larger scale.

The amount of automatic shift is calculated according to the speed of your vessel. The amount of shift is limited to 50% of the range in use. For example, the auto shift speed is 15 knots and the speed of your vessel is 10 knots. The amount of shift is then approximately 33%. The formula to calculate the amount of automatic shift is shown below. Automatic shift is available only in the head-up mode.

$$\frac{\text{Ship's speed}}{\text{Auto shift speed setting}} \times 0.5 = \text{Amount of offcenter(\%)}$$

6.17.1 How to Set Auto Shift Speed

1. Press the **MENU** key to open the menu.
2. Open the [Radar-General] menu.
3. Use the **RotoKey** to select [Auto Shift Maximum Speed].
4. Use the **RotoKey** to set the speed that activates the auto shift.
5. Press the **MENU** key to close the menu.

6.17.2 How to Activate or Deactivate Auto Shift

Method 1: SHIP/3D button

Press the **SHIP/3D** button.

Method 2: RotoKey

1. Long-push the **RotoKey**.
2. Use the **RotoKey** to select [Auto Shift] then push the key to activate or deactivate the automatic shift.

6.18 Sweep Fade

The sweep fade feature automatically reduces the brilliance of weak signals (noise, sea clutter, rain clutter, etc.) and unnecessary echoes like radar interference to clear the picture. Use the sweep fade when unnecessary echoes cannot be reduced by other methods.

1. Press the **MENU** key to open the menu.
2. Open the [Radar-General] menu.
3. Use the **RotoKey** to select [Sweep Fade] then push the key to activate or deactivate the sweep fade.
4. Press the **MENU** key to close the menu.

6.19 How to Show, Hide, Cancel an Active Route

You can show, hide or cancel the active route from the radar display. To hide or show the active route, long-push the **RotoKey**, then select [Active Rte]. Push the **RotoKey** to show or hide the active route.

To cancel route navigation, set the cursor on the line that connects between the boat icon and the destination then push the **right-click** button. The "Cancel Route" pop-up appears. Push the **RotoKey** to cancel the route.

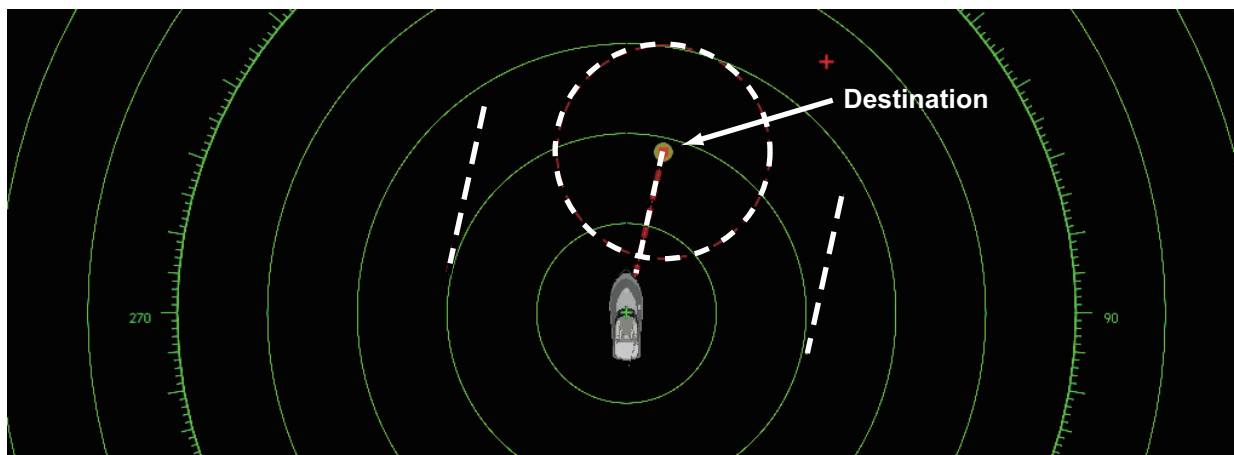

6.20 How to Show or Hide the Boat Icon

You can show or hide the boat icon on the radar display. The icon is shown when the range is shorter than 0.25 nm/0.5 km.

1. Press the **MENU** key to open the menu.
2. Open the [Radar-General] menu.
3. Use the **RotoKey** to select [Own Ship Icon].
4. Push the **RotoKey** to show or hide the icon.
5. Press the **MENU** key to close the menu.

6.21 Echo Color

Echo color is available in single colors of yellow or green or “True.” True paints echoes in colors from red, green and yellow in the order of increasing echo strength.

1. Press the **MENU** key to open the menu.
2. Open the [Radar-General] menu.
3. Use the **RotoKey** to select [Echo Color].



4. Use the **RotoKey** to select a color.
5. Press the **MENU** key to close the menu.

6.22 Background Color

Select the background color for daytime and nighttime operations.

1. Press the **MENU** key to open the menu.
2. Open the [Radar-General] menu.
3. Use the **RotoKey** to select [Day Background Color] or [Night Background Color]. Below are the options for the day background color. (The options for night background color are the same.)

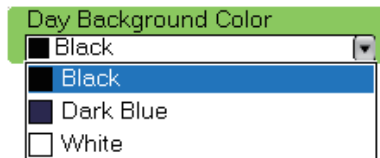

4. Use the **RotoKey** to select a color.
5. Press the **MENU** key to close the menu.

6.23 Radar Overlay Range Link

The radar overlay range link automatically keeps the chart scale and radar range in sync. This feature helps you understand the relation between the radar and the chart. You can activate or deactivate this feature as follows:

1. Press the **MENU** key to open the menu.
2. Open the [Radar-General] menu.
3. Use the **RotoKey** to select [Overlay Range Link].
4. Push the **RotoKey** to activate or deactivate synchronization.
5. Press the **MENU** key to close the menu.

Note: The radar picture can look “out of focus” on long ranges when the range link is active. This out of focus appearance does not indicate a problem, because it is a characteristic of the digital zoom.

6.24 Dual-Range Display

The dual-range display scans and displays two different radar ranges at the same time, with a single antenna. There is no time delay between the two pictures and you have separate control of each picture. This feature lets you keep a close watch on close-range targets and far targets.

The radar functions that are adjusted separately are as follows:

- Active route (show or hide)
- Auto shift
- Echo stretch
- Echo average
- Echo trail (activate or deactivate)
- Gain
- Heading line (show or hide)
- Motion mode (true, relative)
- Orientation mode (course-up, head-up, north-up)
- Rain (rain clutter)
- Range
- Range rings (show or hide)
- Sea (sea clutter)
- Tuning (manual)

To get the dual-range display, set dual-range displays in the display selection window. See section 13.3 for the procedure. You can put the dual-range displays in the two-way, three-way or four-way split screens.

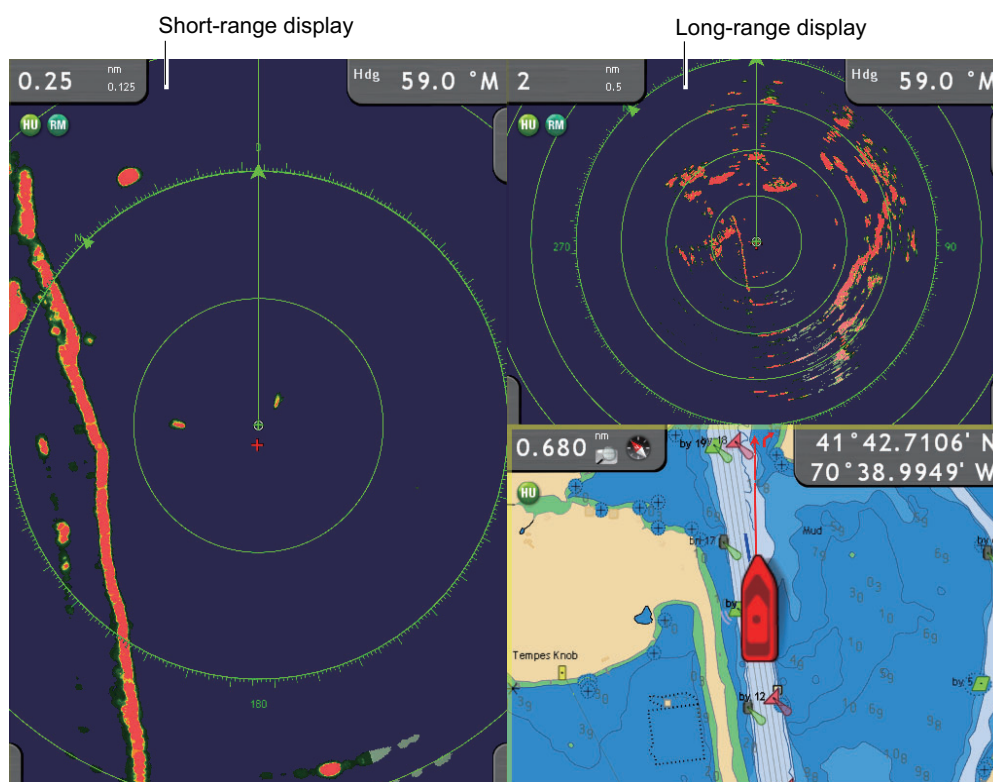

6.25 FAR-2107 Radar Series and NavNet 3D

The FAR-2107 radar series (program no. 02.50 or earlier, C specification) can be connected to your NavNet 3D, and some functions can be controlled from the NavNet 3D. The table shown below shows which features can be controlled from the NavNet 3D. Note that you should turn off Guard Polygon at the radar to control the radar from the NavNet 3D.

Function	Controllable from NavNet	Remarks
AIS data (LAN)	No	
AIS data (NMEA 0183)	No	
AIS data display	Yes	
ARPA acquisition, cancellation	Yes	
Auto Gain	No	
Auto Rain	No	
Auto Sea	Yes	Value of Auto Sea is "0".
Automatic ARPA target acquisition	No	
Dual range mode	No	
Gain	Yes	Manual only
Installation setting (tuning, antenna rotation speed, etc.)	No	
Manual ARPA target acquisition, cancel	Yes	Max. no. of targets is 100.
Position, time data	Yes	Shared via LAN
Range scale	Yes	0.0625, 1, 2, 4, 8, 16, 32, 36, 64, 72, 120 not available with IMO specification. 72 nm not available with C specification.
Selection of range unit	No	Fixed at "NM"
Source selection, picture display	Yes	
TX/STBY	Yes	
Watchman	No	

6.26 How to Understand the Radar Display

6.26.1 False Echoes

Echo signals can appear on the screen at positions where there is no target or disappear where there are targets. You can identify false targets when you understand why the false echoes appear. A description of false echoes follows.

Multiple echoes

Multiple echoes occur when a transmitted pulse returns from a solid object like a large vessel, bridge, or breakwater. A second, a third or more echoes can be seen on the display at two, three or more times the true range of the target as shown below. You can reduce and sometimes remove these multiple echoes if you decrease the gain, or correctly adjust the Sea control.

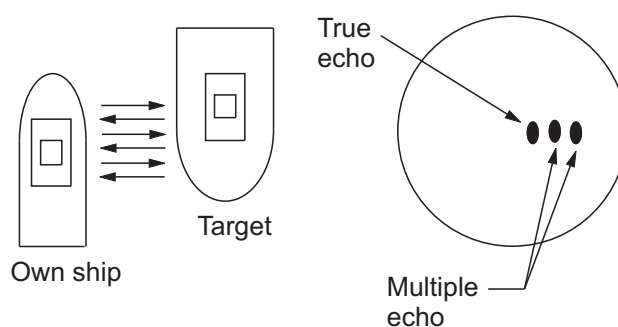

Virtual image

A large target near your vessel can show at two positions on the screen. One of the positions is the true echo reflected by the target. The other position is a false echo which is caused by the “mirror effect” of a large object on or near your vessel. See the figure shown below for an example of this type of false echo. If your vessel gets near a large metal bridge, for example, a false echo appears on the screen. The echo disappears after move some distance from the bridge.

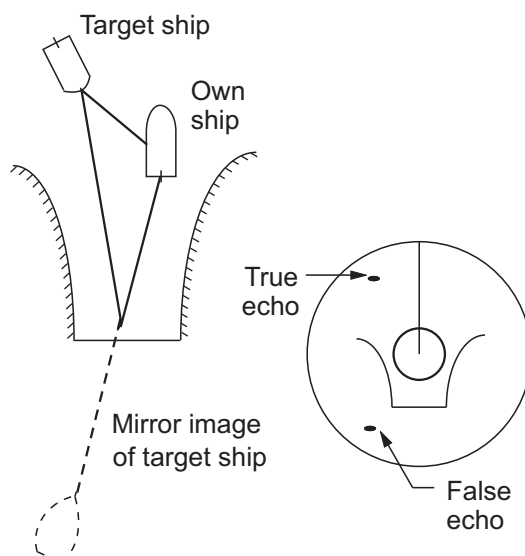

Shadow sector

Funnels, stacks, masts, or derricks in the path of the antenna stop the radar beam. If the angle opposite the antenna is more than one or two degrees, a sector or shadow sector appears on the screen. Targets are not displayed within the sector.

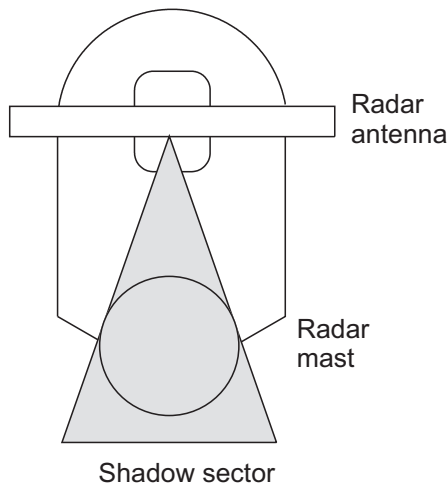

Sidelobe echoes

Each time the radar transmits, some radiation leaves on each side of the beam. This lost energy has the name "sidelobes." If a target is detected by both the sidelobes and the mainlobe, the sidelobe echoes can appear at both sides of the true echo at the same range. Sidelobes normally show only on short ranges and from strong targets. You can reduce sidelobes if you reduce the gain, or correctly adjust the Sea control.

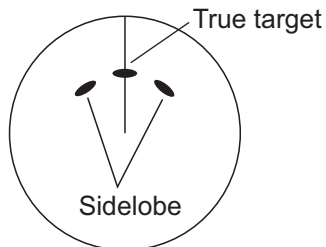

6.26.2 Search and Rescue Transponder (SART)

A vessel in distress uses a radar-SART to show a series of dots on the radar display of nearby vessels to indicate distress. A SART transmits when it receives a radar pulse from any X-Band (3 cm) radar within a range of approximately 8 nm. When a SART receives a radar pulse, the SART transmits a response across all the radar frequency band. The SART first sweeps quickly ($0.4 \mu\text{s}$) through the band. The SART then slowly sweeps ($7.5 \mu\text{s}$) through the band back to the starting frequency. Each sweep is repeated 12 times. At some point in each sweep, the SART frequency matches that of the radar and is within the baseband of the radar receiver. If the SART is within range, the frequency match during each of the 12 slow sweeps creates a line of 12 dots, 0.64 nautical miles between dots.

When the range to the SART is reduced to approximately 1 nm, the radar display shows the 12 responses created during the fast sweeps. The dots from the fast sweeps, which are 0.64 nm from one another, appear with the 12 dots created from the slow sweeps. The dots from the fast sweeps are weaker and smaller than the dots from the slow sweeps.

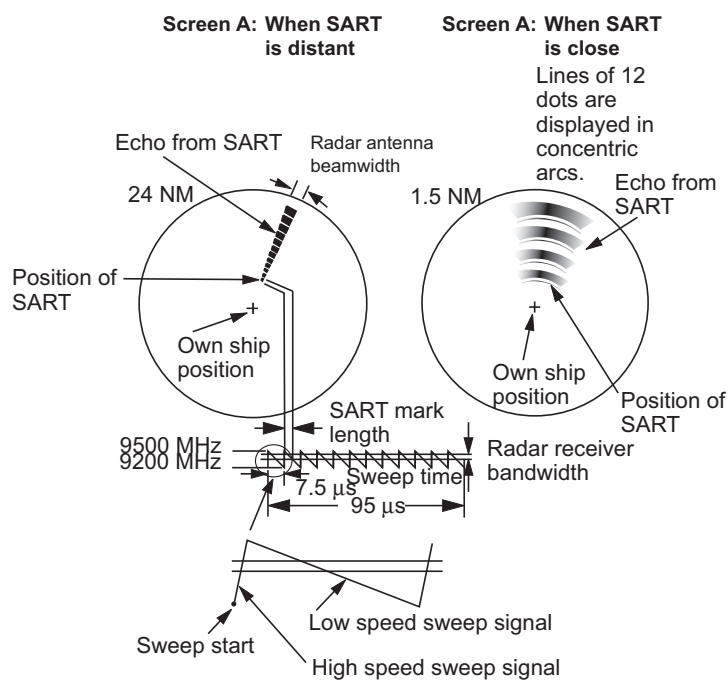

How to detect the SART response

- Use the range scale of 6 or 12 nm. The distance between the SART responses is approximately 0.6 nm (1125 m) to identify the SART.
- Turn off all the automatic clutter filters.
- Turn off the interference rejector.

Racon (Radar Beacon)

A racon is a radar transponder that sends a characteristic signal when the racon receives a radar pulse (normally only the three-centimeter band). If the racon signal is sent on the same frequency as that of the radar, the signal appears on the radar display. The racon signal appears on the radar in one of two methods:

- A line that starts just after the position of the Racon
- A Morse code signal displayed with a line just after the position of the Racon



6.27 ARPA Operation

The ARPA (Automatic Radar Plotting Aid) shows the movement of a maximum of 30 radar targets. The targets can be acquired manually or automatically. All 30 targets can be acquired manually when the ARPA acquisition area is not active. If the ARPA acquisition area is active, that total is equally divided between manual and auto acquisition.

ARPA requires speed and heading data.

 WARNING
<p>No one navigational aid should be relied upon for the safety of vessel and crew. The navigator has the responsibility to check all aids available to confirm position. Electronic aids are not a substitute for basic navigational principles and common sense.</p> <ul style="list-style-type: none"> • This auto plotter automatically tracks an automatically or manually acquired radar target and calculates its course and speed, indicating them by a vector. Since the data generated by the auto plotter are based on what radar targets are selected, the radar must always be optimally tuned for use with the auto plotter, to ensure required targets will not be lost or unwanted targets such as sea returns and noise will not be acquired and tracked. • A target does not always mean a land-mass, reef, ships or other surface vessels but can imply returns from sea surface and clutter. As the level of clutter changes with environment, the operator should properly adjust the Sea, Rain and Gain to be sure target echoes are not eliminated from the radar screen.



 CAUTION
<p>The plotting accuracy and response of this auto plotter meets IMO standards. Tracking accuracy is affected by the following:</p> <ul style="list-style-type: none"> • Tracking accuracy is affected by course change. One to two minutes is required to restore vectors to full accuracy after an abrupt course change. (The actual amount depends on gyrocompass specifications.) • The amount of tracking delay is inversely proportional to the relative speed of the target. Delay is on the order of 15–30 seconds for high relative speed; 30–60 seconds for low relative speed.
<p>Display accuracy is affected by the following:</p> <ul style="list-style-type: none"> • Echo intensity • Radar transmission pulsewidth • Radar bearing error • Gyrocompass error • Course change (own ship or target)

6.27.1 How to Show or Hide the ARPA Display

1. On the chart plotter or radar display, long-push the **RotoKey**.
2. Use the **RotoKey** to select [Targets] followed by ARPA.
3. Push the **RotoKey** to show or hide the ARPA display.

6.27.2 How to Manually Acquire a Target

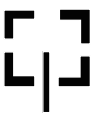
After you acquire a target, the radar marks the target with a broken square and a vector appears within 30 s. The vector indicates the direction of the target. Within 90 s after you acquire the target, the first tracking step is finished and the target is tracked continuously. At this point, the broken square changes to a solid circle.

ARPA Symbol	Meaning
	At acquisition of the target.
	30 s after the acquisition a vector appears to show the direction of the target.
	Within 90 s after the acquisition, the plotting symbol changes to a small circle, which indicates steady-state tracking.
	A Lost target is indicated by a diamond symbol, created from two equal triangles.

Note 1: For successful acquisition, the target must be within 0.05 to 16 nm from your vessel and not hidden in sea or rain clutter.

Note 2: When the capacity for manual acquisition is reached, you cannot acquire more targets. Cancel tracking of non-threatening targets to acquire additional targets manually.

How to acquire a target for ARPA from the radar display

1. On the radar display, use the CursorPad to put the cursor on a target.
2. Press the **right-click** button to show the Radar pop-up menu, shown in the illustration at right.

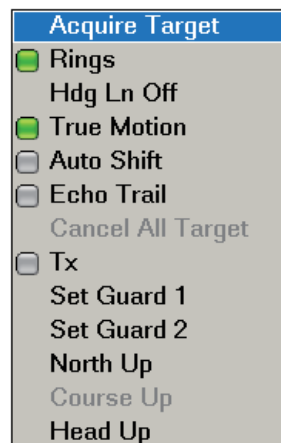

3. [Acquire Target] is selected. Push the **RotoKey** to acquire the target.

How to acquire a target for ARPA from the radar overlay display

1. On the radar overlay display, use the CursorPad to put the cursor on a target.
2. Press the **right-click** button to show the pop-up menu.
3. Use the **RotoKey** to select [Acquire Target] then push the key.

6.27.3 How to Display Target Data

You can find the course, speed, range, bearing, etc. of an ARPA target. For simple data, put the cursor on the ARPA target. For detailed data, put the cursor on the target then push the **left-click** button.

ID	1
COG/SOG	56.2°T/6.8 kt
CPA/TCPA	3 nm/55m03s
Range/Bearing	6.366 nm/26.7°T

ARPA simple target data

Object Detail	
ID	1
COG	56.2°T
SOG	6.8 kt
CPA	3 nm
TCPA	55m03s
Range	6.366nm
Bearing	26.7°T
Position	34°37.1715'N; 135°10.2459

ARPA detailed target data

6.27.4 How to Stop Tracking Targets

You can stop tracking ARPA targets separately or all together from the ARPA pop-up menu. Tracking of all targets can also be stopped from the Radar pop-up menu.

1. Use the CursorPad to put the cursor on the ARPA target.
2. **Right-click** to show the ARPA pop-up menu.

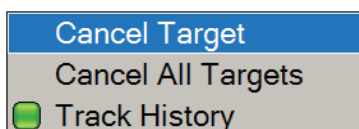

3. Use the **RotoKey** to select [Cancel Target] or [Cancel All Targets] then push the **RotoKey**.

Tracking is cancelled and targets are erased from the screen.

6.27.5 How to Clear a Lost Target

Put the cursor on a lost target then press the **right-click** button to show the Lost Target pop-up menu. Use the **RotoKey** to select [Clear lost] or [Clear all Lost Targets].

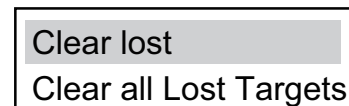

6.27.6 CPA/TCPA Alarm

The CPA/TCPA alarm helps warn of possible collision conditions. The ARPA continuously monitors the predicted range at the Closest Point of Approach (CPA) and predicted time to CPA (TCPA) of each tracked target. When the predicted CPA or TCPA is less than their set values, the buzzer sounds and a text message appears.

This alarm helps you keep your vessel away from collision by warning of targets on a collision course. Make sure that the gain, sea and rain controls are correctly adjusted before you use this alarm.

CPA/TCPA alarm ranges must be set correctly according to the size, tonnage, speed, turning performance and other characteristics of your vessel.

How to set the CPA/TCPA Alarm

1. Press the **MENU** key to open the menu.
2. Open the [Alarm-Target] menu, shown below.

The screenshot shows a menu titled "Radar Source" with the following options and settings:

- RADAR** (selected)
- Echo Guard Alarm**
- CPA/TCPA Alarm**
- CPA Alarm Value**: 00.0 nm
- TCPA Alarm Value**: 00m
- Proximity AIS Target Alarm**
- Proximity AIS Target Alarm V...**: 000 ft
- Reset Default Settings** (button)
- Exit Menu** (button)

3. Use the **RotoKey** to select [CPA/TCPA Alarm] then push the key to activate the alarm on (status icon in green).
4. Use the **RotoKey** to set CPA and TPCA values at [CPA Alarm Value] and [TCPA Alarm Value].
5. Press the **MENU** key to close the menu.

How to acknowledge the CPA/TCPA Alarm

The CPA/TCPA alarm sounds when the CPA and TCPA of an ARPA target are within the CPA/TCPA alarm range. To acknowledge the alarm and stop the audio alarm, press the **CANCEL** key. (The ARPA vector must be displayed at least 30 seconds to calculate CPA and TCPA.)

How to deactivate the CPA/TCPA Alarm

Show the status icon of CPA/TCPA Alarm in the [Alarm-Target] menu in gray to deactivate the CPA/TCPA alarm.

6.27.7 How to Set an ARPA Acquisition Area

Any target that enters a ARPA acquisition area is acquired and tracked automatically. When a target leaves the area, the buzzer sounds. You can stop the buzzer with the **CANCEL** key.

1. On the radar display, push the **right-click** button to show the Radar pop-up menu.

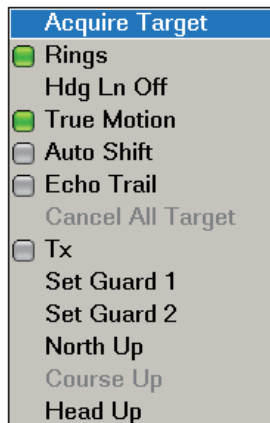

2. Use the **RotoKey** to select [Set Guard 1] or [Set Guard 2], the guard zone to set. The cursor appears at the cursor location.
3. Use the CursorPad to put the cursor at the top-left corner for the guard zone (Point A in the illustration on the next page).
4. Press the **left-click** button.
5. Use the CursorPad to move the cursor to the bottom right corner (Point B below) for the guard zone then push the **left-click** button.



Note 1: To set a 360-degree guard zone, set the same bearing for both the position A and position B.

Note 2: The location of points A and B control the shape of the guard zone. Below are three examples.

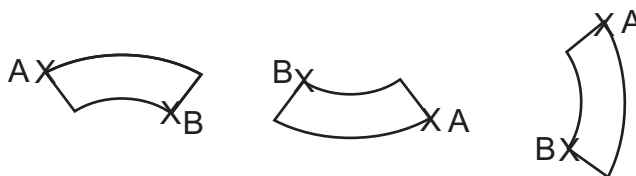

How to use a guard zone as a ARPA acquisition zone

Open the [Targets] menu then activate [Guard Zone AUTO Acq].

How to erase the acquisition zone and return to full manual acquisition

Put the cursor on a line of the guard zone then push the **right-click** button. (The line becomes thicker if correctly selected.) The Guard Zone pop-up appears. Use the **RotoKey** to select [Clear Guard].

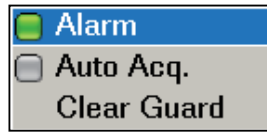
**6.27.8 Track History Display**

The track of ARPA targets can be shown on the display with a line from the rear of the targets.

How to show or hide the track history display

On the radar display or the chart plotter display, long-push the **RotoKey** to show the soft controls. Select [Targets] then [History]. Push the **RotoKey** to show or hide the track history display.

How to select a track history plotting interval

You can select the track history plotting interval from the times shown below. For long plotting intervals, the time at which a point is added to the track is calculated by dividing the total length in seconds by 20 (points). For example, a point is added every 18 s if the plotting interval is 6 m (360 divided by 20 is 18). The track history display is reset when the plotting interval is changed.

1. Press the **MENU** key to open the menu.
2. Open the [Targets] menu.
3. Use the **RotoKey** to select [Track History Length].

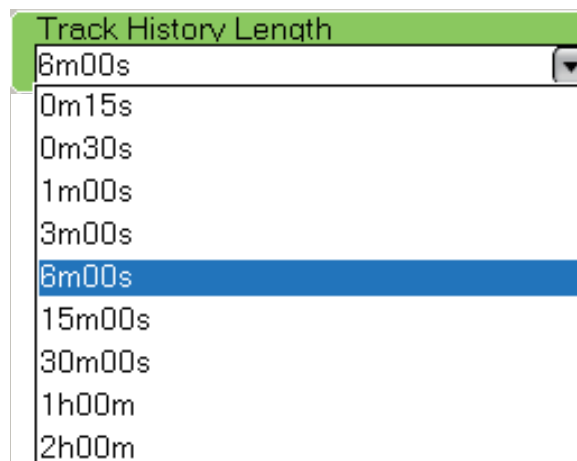

4. Use the **RotoKey** to select a plot interval.
5. Press the **MENU** key to close the menu.

7. FISH FINDER

This chapter describes the functions of the fish finder, which requires the Bottom Discrimination Sounder BBDS1, Network Sounder DFF series, ETR-6/10N or ETR-30N, or Color LCD Sounder FCV-1150.

Many procedures in this chapter require you to open the "fish finder source menu." This menu has the name [DFF1/BBDS1/DFF1-UHD], [DFF3/FCV], [ETR-6/10N] or [ETR-30N], depending on your system. Instead of writing all menu names, we write "fish finder source." For example, "Open the [Fish Finder-fish finder source] menu."

7.1 How the Fish Finder Operates

The fish finder calculates the distance between its transducer and underwater objects like fish, lake bottom or seabed. The results are shown in different colors or shades of gray according to echo strength.

The ultrasonic waves transmitted through water move at a constant speed of approximately 4800 feet (1500 meters) per second. When a sound wave "hits" an underwater object like fish or sea bottom, part of the sound wave is reflected toward the source. To find the depth to an object, the fish finder calculates the time difference between the transmission of a sound wave and the time the reflected sound wave is received.

The picture displayed by the fish finder contains a series of vertical scan lines. Each line is a "picture" of the objects under the boat. The series of pictures are put side-by-side across the screen to show the contours of the bottom and echoes from fish. The amount of history of objects that have moved under the boat can be less than a minute to more than one minute depending on the picture advance speed.

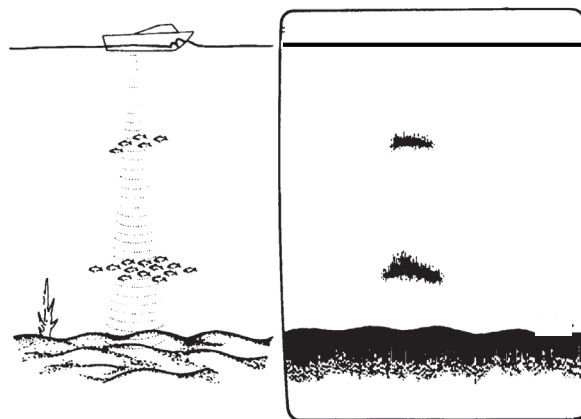

7.2 How to Select a Display

Your fish finder has as many as seven display modes. These modes are single frequency, dual frequency, marker zoom, bottom zoom, bottom lock, A-scope, and bottom discrimination (requires Bottom Discrimination Sounder BBDS1 and specified transducer).

7.2.1 Single Frequency Display

The single frequency display shows either the low-frequency or high-frequency picture on all the screen. Select a frequency according to your purpose.

- A low frequency gives a wide detection area. Use the low frequency for general search and to find bottom conditions.
- A high frequency gives better resolution. Use the high frequency to inspect a school of fish.

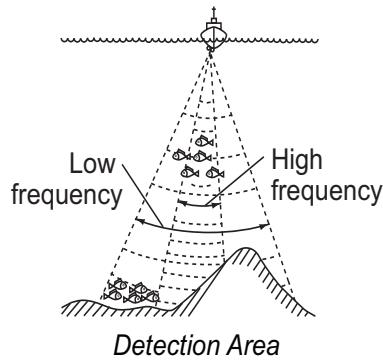

How to select a single-frequency display

Push the **RotoKey** to show the soft controls. Use the **RotoKey** to select [LF] (low frequency) or [HF] (High Frequency).

Note: For the FCV-1150, this function is inoperative when the FCV-1150's NavNet menu is set for Gain/Mode. The message shown right appears. Use the **RotoKey** to click the **OK** button.

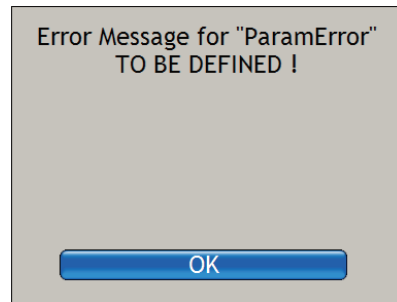

How to select the active TX frequency with the frequency selector icon

The frequency selector icon, at the top-left corner, switches between low and high frequencies. Put the cursor on the icon then push the **left-click** button to switch between high and low frequencies.

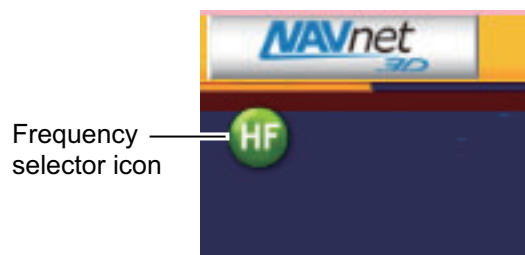

7.2.2 Dual Frequency Display

The dual frequency display provides both low- and high-frequency pictures. Use the dual frequency display to compare the same picture with two different sounding frequencies. The low-frequency picture is on the left, and the high-frequency is on the right.

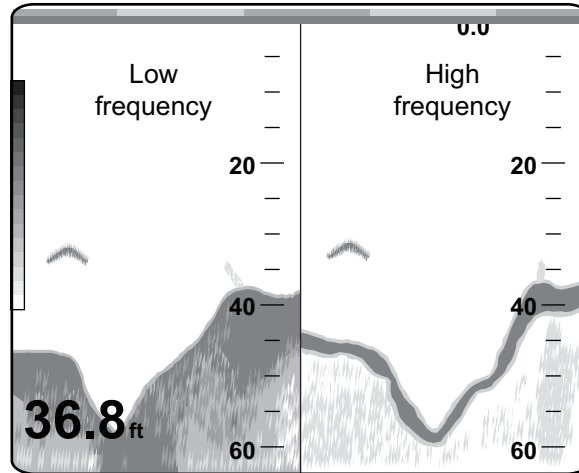

Freq. (kHz)	Beamwidth	Resolution	Detection range	Bottom tail
50	Wide	Low	Deep	Long
200	Narrow	High	Shallow	Short

How to select the dual frequency display

Use the **RotoKey** to select [HF] and [Dual].

Note: For the FCV-1150, this function is inoperative when the FCV-1150's NavNet menu is set for Gain/Mode.

How to switch to single frequency display with the frequency selector icon

Click either frequency selector icon. The dual-frequency mode is cancelled and the high frequency display appears.

7.2.3 Zoom Displays

How to activate a zoom display

Push the **RotoKey** to show the soft controls. Select [Zoom], [Btm Lock], [Btm Zoom] or [Mkr Zoom] as necessary. Select [Off] to quit the zoom display and go to the single frequency display.

How to change the active zoom display

Click the zoom display selector icon (at the top-left corner) with the **left-click** button to change the active zoom display.

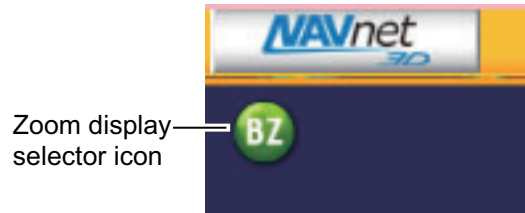

Marker-zoom display

The marker-zoom display expands a selected area of the normal fish finder picture to full vertical size of the screen on the left-half window. You can indicate the part to expand with the VRM (Variable Range Marker). Move the marker with the CursorPad. The area between the VRM and zoom marker is expanded. The length of the segment is equal to one division of the depth scale.

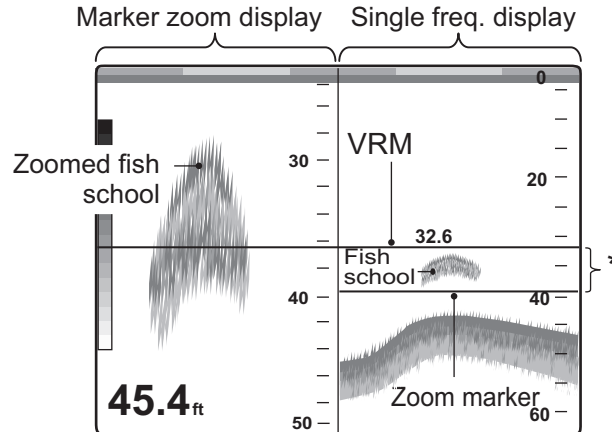

* This area zoomed on left half of screen.

Bottom-zoom display

The bottom-zoom display expands the bottom and the fish near the bottom according to the zoom range selected on the [Fish Finder-fish finder source] menu. This display helps you find the density of the bottom. A bottom displayed with a short echo tail normally indicates the bottom is soft (sand bottom, etc.). A long echo tail indicates a hard bottom.

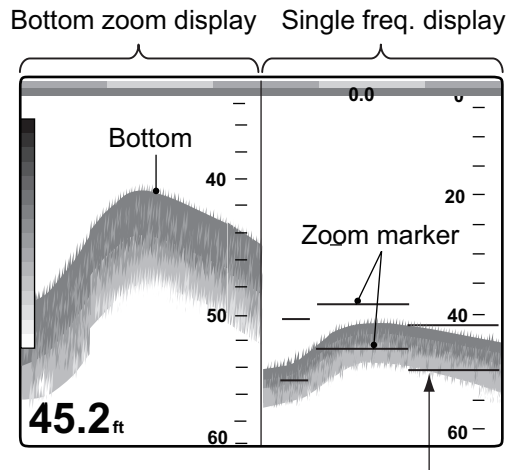

Zoom marker automatically follows change in depth.

Bottom-lock display

The bottom-lock display provides a compressed normal picture on the right half and a 7 to 400 feet (3 to 120 meter) wide layer in contact with the bottom is expanded on the left half. This display helps you separate the fish near the bottom from the bottom echo. You can select the bottom lock range with [Bottom Lock Range Span] in the [Fish Finder-fish finder source] menu.

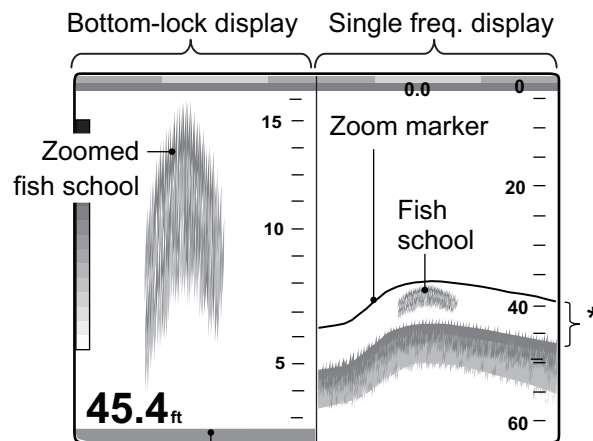

Bottom shown as a straight line

*This area zoomed and displayed on left 1/2 of screen.

7.2.4 A-scope Display (display only)

The A-scope display appears at the right 1/16 of the screen and is available in any fish finder mode. This display shows the echoes at each transmission with the amplitudes and tone in balance with their intensities. This display helps you identify possible fish species and bottom structure.

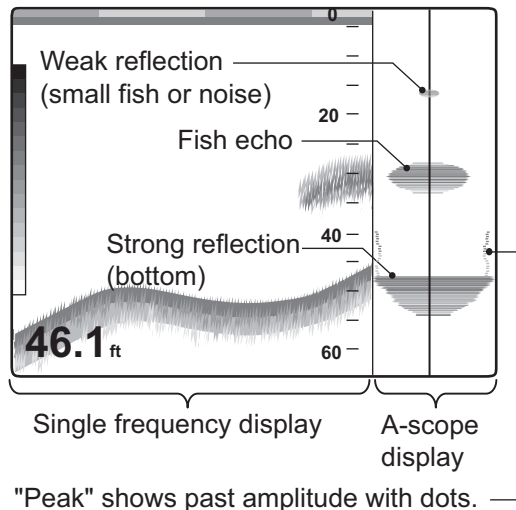

How to show or hide the A-scope display

Use the **RotoKey** to select [A-scope] then push the key to show or hide the A-scope display.

A-scope peak hold

You can show the "normal" A-scope display plus the peak-hold amplitude picture for the last five seconds in dots. To show the peak hold display, open the [Fish Finder-General] menu. Use the **RotoKey** to select [A-Scope Peak Hold] then push the key to activate or deactivate peak hold.

7.2.5 Bottom Discrimination Display

The bottom discrimination display, available with the Bottom Discrimination Sounder BBDS1 and appropriate transducer, identifies probable bottom composition. The display is available in all screen divisions, single or dual frequency mode and occupies the bottom 1/6 of the screen in the full screen display. There are two types of bottom discrimination displays: standard and probability. The standard display shows the most probable bottom composition by graphic or four colors. The probability display shows the most probable bottom composition in graph form.

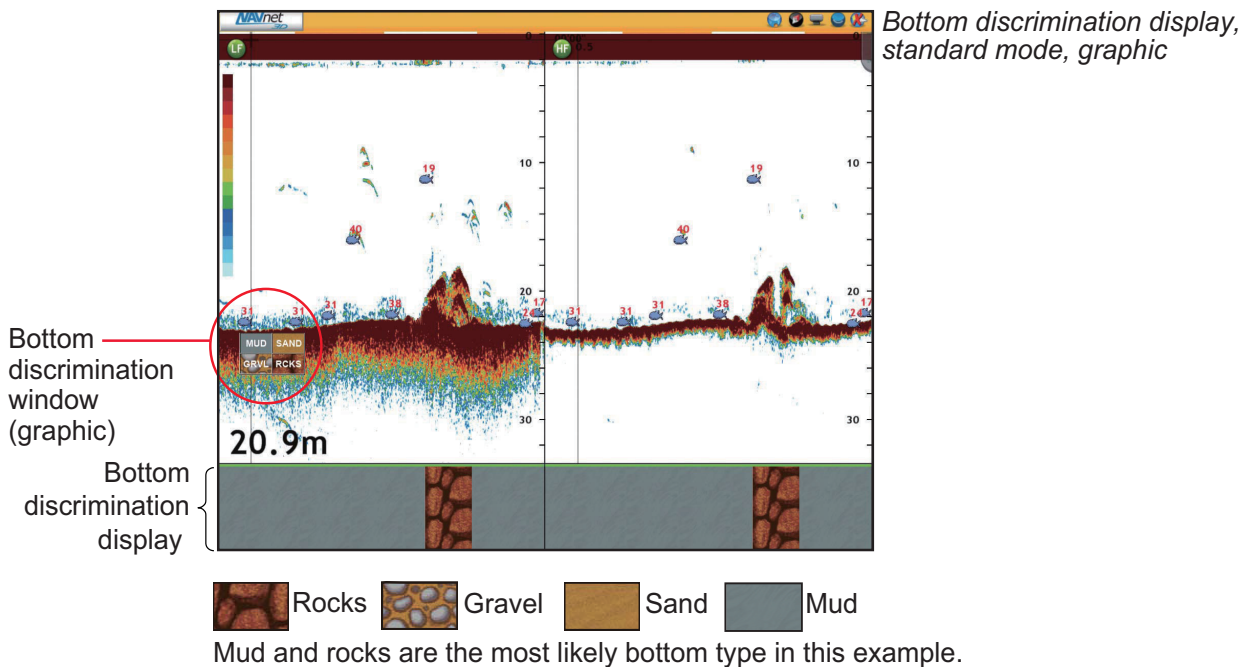
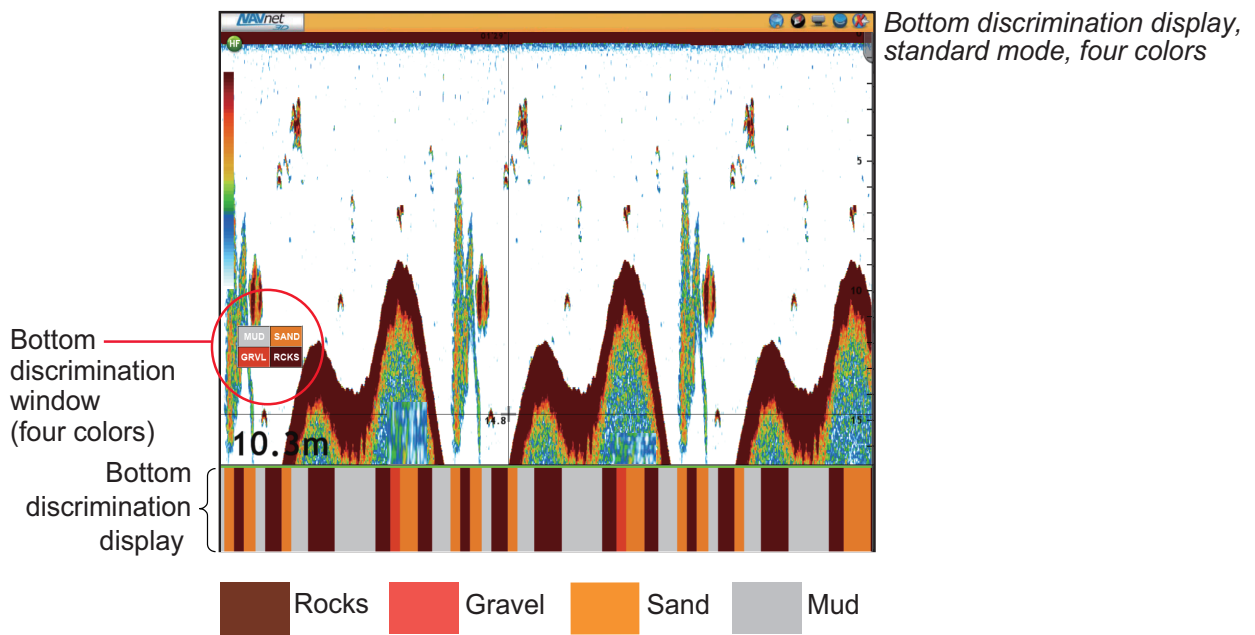

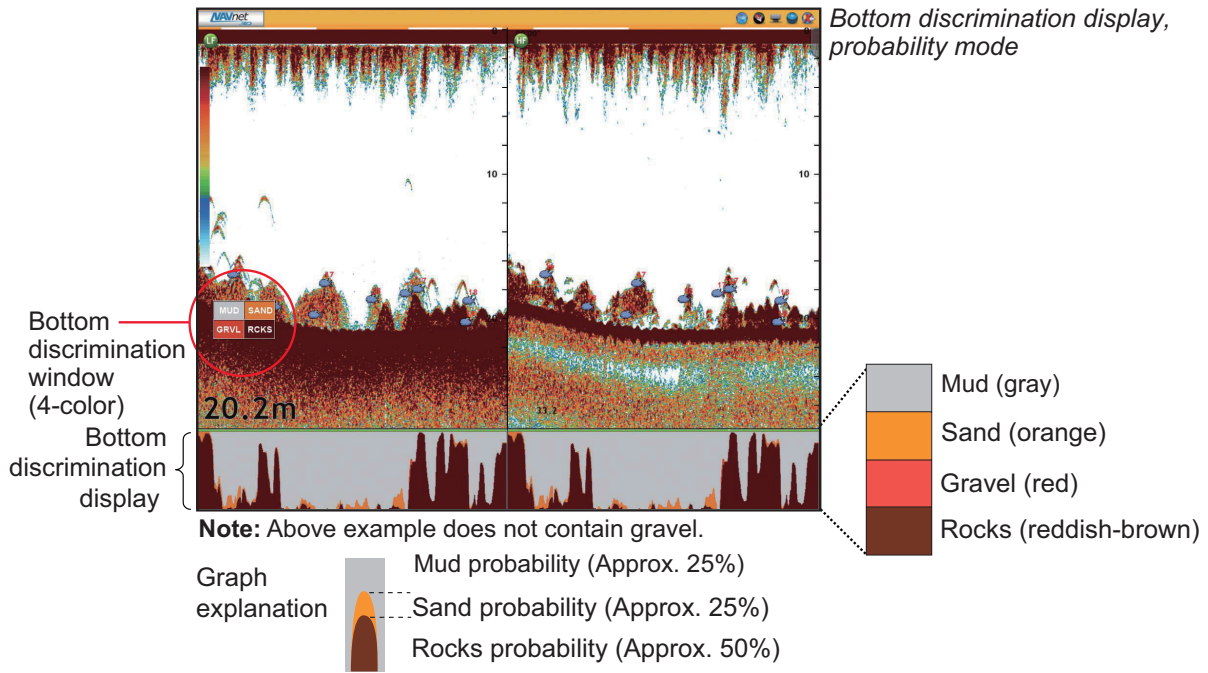

How to active, deactivate the bottom discrimination display

Use the **RotoKey** to select [Btm disc] then push the key to activate or deactivate the bottom discrimination display.

How to set the bottom discrimination display

Follow the procedure below to set the bottom discrimination display.

1. Press the **MENU** key to open the menu.
2. Use the **RotoKey** to select the [Fish Finder-DFF1/BBDS1/DFF1-UHD] menu. Scroll the menu to display the bottom discrimination display menu items, shown in the illustration below.

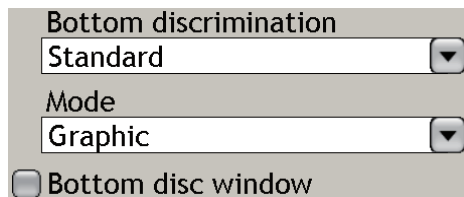

3. Use the **RotoKey** to select [Bottom discrimination] then push the **RotoKey**.

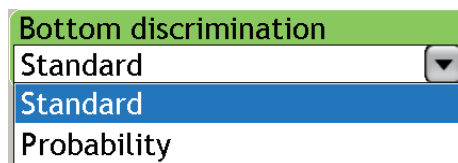

4. Use the **RotoKey** to select [Standard] or [Probability] then push the **RotoKey**.
Standard: Show the most probable bottom composition in 4 colors or graph form.
Probability: Show the most probable bottom composition in graph form.

- Use the **RotoKey** to select [Mode] then push the **RotoKey**.

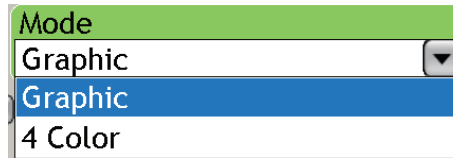

- Use the **RotoKey** to select [Graphic] or [4 Color] then push the **RotoKey**.
Graphic: Show the bottom discrimination window in graph from. (Not available when [Bottom discrimination] is selected to [Probability].) **4 color:** Show the bottom discrimination window in 4 colors.
- Use the **RotoKey** to select [Bottom disc window].
- Push the **RotoKey** to show or hide the bottom discrimination window.
- Press the **MENU** key to close the menu.

7.3 Automatic Fish Finder Operation

Your fish finder can be adjusted automatically to let you do other tasks.

7.3.1 How the Automatic Fish Finder Operates

The automatic fish finder function automatically adjusts the gain, clutter, TVG and echo offset and range (ETR series only). The main features of the automatic mode are as shown below.

- Gain adjusts the sensitivity of the receiver to show the bottom echo in reddish-brown (default color arrangement).
- Clutter automatically reduces low-level noise like plankton.
- The TVG function is automatically adjusted.
- The echo offset balances the gain on high and low frequencies.
- Range is adjusted automatically to show the bottom echo.

7.3.2 How to Select an Automatic Fish Finder Mode

There are two types of automatic fish finder modes: Cruising and Fishing. Cruising tracks the bottom, and Fishing searches for schools of fish. Cruising uses a higher clutter removal setting than Fishing. Do not use Cruising when your purpose is to find fish, because the clutter removal circuit can erase weak echoes.

To select an automatic fish finder mode:

- Push the **RotoKey**.
- Use the **RotoKey** to select [Auto] followed by [Fishing] or [Cruising].

The items controlled automatically depend on the fish finder source, as shown in the table.

Fish finder source	Automatic control
ETR series	Gain, clutter, TVG, echo offset, and range
DFF series, BBDS1	Gain, clutter, TVG, and echo offset
FCV-1150	Gain, clutter, TVG, and echo offset

7.4 Manual Fish Finder Operation

Use the manual operation to see schools of fish and the bottom echo with a fixed gain setting.

The gain, range and range shift functions let you select the depth you can see on the screen. The basic range provides a "window" into the water column and range shift moves the "window" to the depth that you select.

7.4.1 How to Select the Manual Mode

Use the **RotoKey** to select [Auto] followed by [Off].

7.4.2 How to Select a Display Range

Operate the **RANGE** key to select a range, that is, the maximum depth to display. (The range cannot be changed in the automatic mode.)

For the BBDS1, DFF series, FCV-1150, range can be selected automatically or manually. Push the **RotoKey** to show the soft controls. Select [Auto Range] then push the **RotoKey** to select [Auto] or [Manual] as applicable.

Individual range selection for high and low freq. (BBDS1, DFF series, FCV-1150)

You can set the range individually for high and low frequencies. Activate the dual frequency mode, turn off auto range and then do the following:

1. Push the **RotoKey**.
2. Rotate the **RotoKey** to select [Split Range] followed by [HF] or [LF].
3. Push the **RANGE** key to choose range for selected frequency.

To set the range for high and low frequencies together, use the **RotoKey** to select [Individual] then [Off].

7.4.3 How to Shift the Range

The basic range and range shift functions let you select the depth you can see on the screen. This function is not available when the Auto range mode is active.

Operate ▲ or ▼ on the ScrollingPad to shift the range.

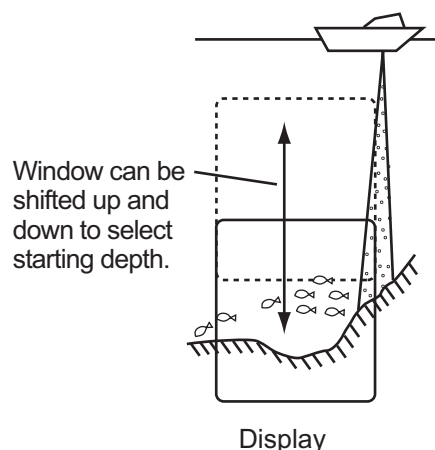

7.4.4 How to Adjust the Gain

The gain controls how echoes of different strengths are displayed. Set the gain to show a slight amount of noise on the screen. Increase the gain for greater depths and lower the gain for shallow waters.

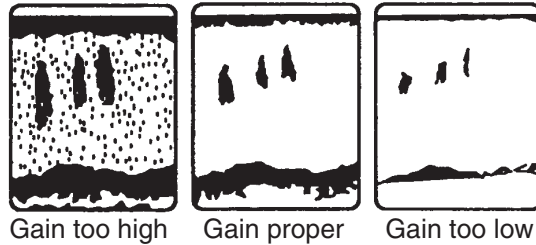

Press the **GAIN/TX** key to show the gain window. [Gain HF] is selected. Rotate the **RotoKey** to adjust the gain then push the key to set. The current level is shown on the bar, and the setting range is 0-100(%). To adjust the low frequency, push the key again to select [Gain LF] then use the **RotoKey** to adjust.



Note: For the FCV-1150, this function is inoperative when the FCV-1150's NavNet menu is set for Gain/Mode.

7.4.5 How to Reduce Clutter

Low intensity “spots” of noise appear over most of screen like in the illustration shown below. These spots of noise are caused by sediment in the water or noise. You can reduce this type of noise with [Clutter] on the [Fish Finder-fish finder source] menu.

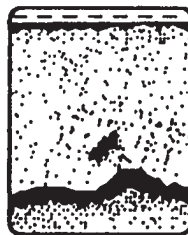

1. Press the **MENU** key to open the menu.
2. Open the [Fish Finder-fish finder source] menu.
3. Use the **RotoKey** to select [Clutter].



4. Rotate the **RotoKey** to adjust the clutter percentage level then push the **RotoKey** knob.
5. Press the **MENU** key to close the menu.

7.5 Picture Advance Speed

The picture advance speed controls how quickly the vertical scan lines move across the screen. A fast advance speed expands the size of a school of fish horizontally on the screen. A slow advance speed shortens the school of fish. Use a fast advance speed to see the hard bottom. Use a slow advance speed to see the smooth bottom.

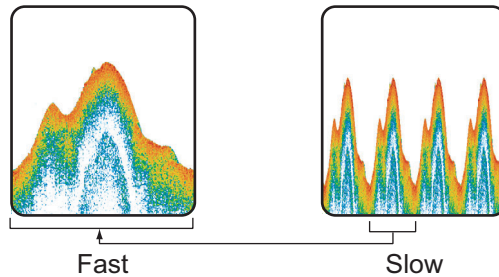

1. Press the **MENU** key to open the menu.
2. Open the [Fish Finder-fish finder source] menu.
3. Use the **RotoKey** to select [Picture Advance].

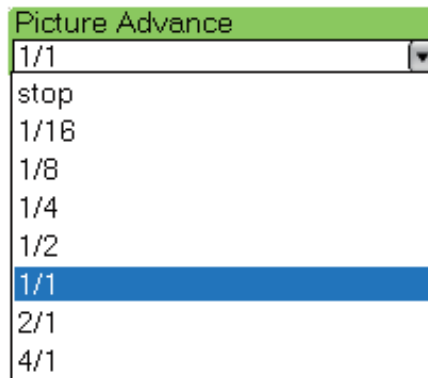

4. Use the **RotoKey** to select a picture advance speed. The options in the window indicate the number of scan lines made per transmission. For example, "1/2" creates one scan line per two transmissions. 1/16 is the slowest advance speed and 4/1 is the fastest speed. "Stop" stops picture advance, and is useful for taking a photo of the screen.
5. Press the **MENU** key to close the menu.

7.6 How to Reduce Interference

Interference from other fish finders and electrical equipment appears on the screen as shown in the illustration. When these types of interference appear on the screen, use the interference rejector to reduce the interference. Three or four levels are available depending on the fish finder source. Turn off the interference rejector when there is no interference, so that you do not erase weak echoes.



Interference from
other sounder

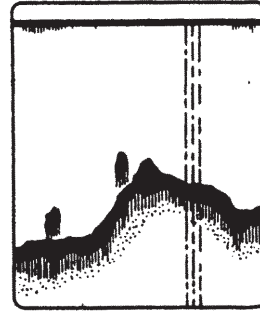

Interference from
electrical equipment

1. Press the **MENU** key to open the menu.
2. Open the [Fish Finder-fish finder source] menu.
3. Use the **RotoKey** to select [Interference Rejection].

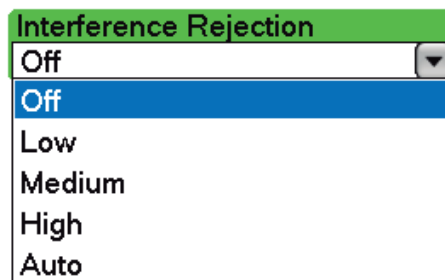

BBDS1/DFE series/FCV-1150

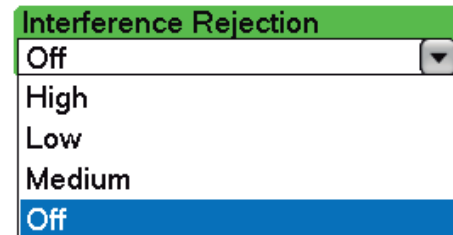

ETR-6/10N, ETR-30N

4. Use the **RotoKey** to select [Off], [Low], [Medium], [High] or [Auto]. [Auto], available with the BBDS1, DFE series and FCV-1150, automatically selects proper interference setting.
5. Press the **MENU** key to close the menu.

7.7 How to Measure Depth, Time Between Locations

You can measure the depth to an object with the VRM. Also, you can measure the time from the right edge to a location. For example, you can measure how many minutes ago an echo appeared.

To measure the depth or the time to a location, operate the CursorPad to put the VRM on the object to measure depth or time. Read the depth below the VRM and the time at the top of the screen.

The VRM cannot be operated when the Gain adjustment window is active.

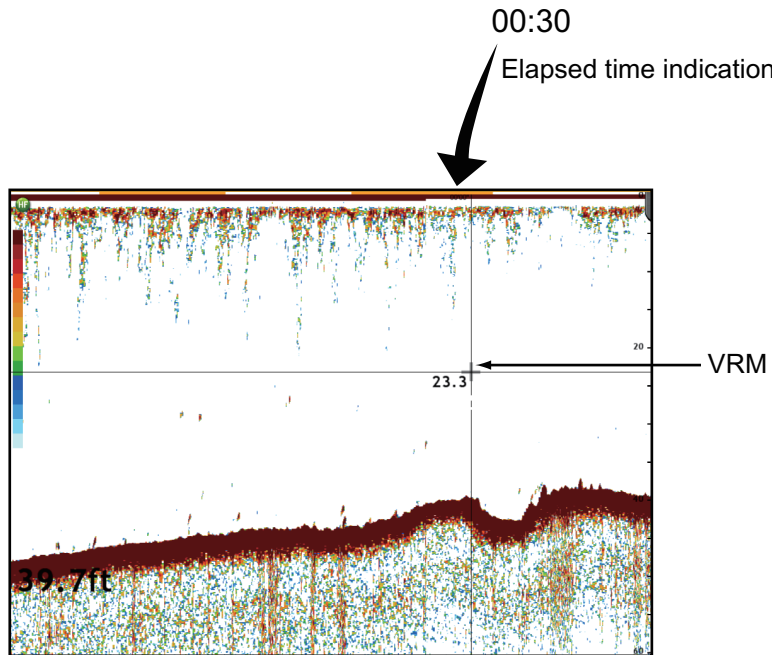

7.8 How to Erase Weak Echoes

Sediment in the water and reflections from plankton appear on the display in low-intensity colors. You can erase these weak echoes with [Color Erase] on the [Fish Finder-fish finder source] menu.

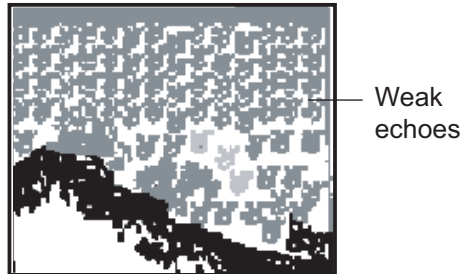

1. Press the **MENU** key to open the menu.
2. Open the [Fish Finder-fish finder source] menu.
3. Use the **RotoKey** to select [Color Erase].



4. Rotate the **RotoKey** to select the percentage of colors to erase then push the **RotoKey** to validate your setting. Select a low percentage to erase weak echoes. Increase the percentage to erase strong echoes.
5. Press the **MENU** key to close the menu.

7.9 How to Balance Echo Strength

A school of fish at a depth deeper than a school of equal strength in shallow water appears in weaker colors. This condition is caused by the movement attenuation of the ultrasonic wave. To display the schools of fish in the same colors, use the TVG. The TVG automatically increases the gain with depth so that echoes of the same strength and different depths are shown in the same colors. In the illustration shown below, for example, the TVG is set for 100 m and the TVG level is adjusted. Unnecessary echoes at a distance less than 100 m are deleted and echoes at depths greater than 100 m are not adjusted.

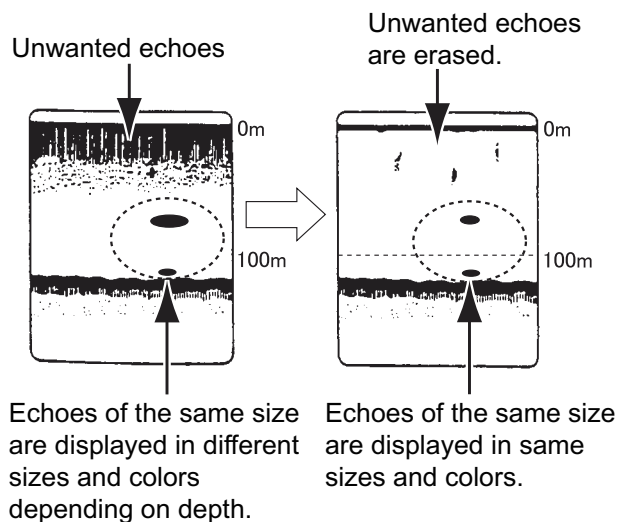

1. Press the **MENU** key to open the menu.
2. Open the [Fish Finder-fish finder source] menu.
3. Select [TVG HF] (high frequency) or [TVG LF] (low frequency) then push the **RotoKey**.



4. Rotate the **RotoKey** to adjust the TVG. Raise the TVG to increase the gain difference between near and far distances.
5. Press the **MENU** key to close the menu.

7.10 White Marker

The white marker displays the selected echo color in white. Use this feature to distinguish fish near the bottom from the bottom echo.

1. Press the **MENU** key to open the menu.
2. Open the [Fish Finder-fish finder source] menu.
3. Use the **RotoKey** to select [White Marker].

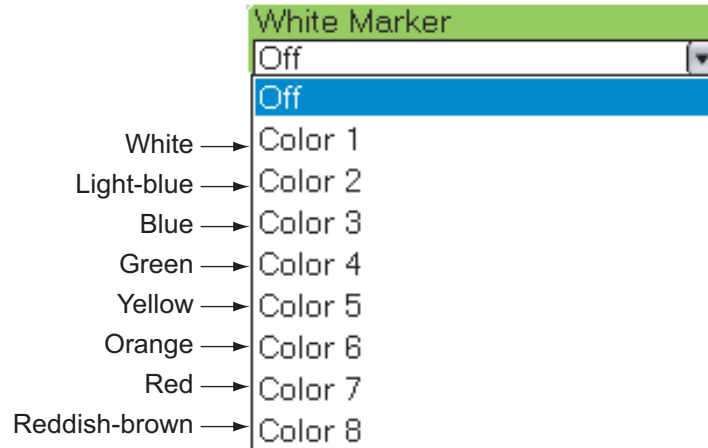

4. Use the **RotoKey** to select the echo color to display in white.
5. Press the **MENU** key to close the menu.

7.11 Fish Finder Alarms

Two types of fish alarms release audio and visual alarms to tell you to that echoes from fish are in the area you selected. These alarms are the fish alarm and bottom lock fish alarm.

The **fish alarm** tells you when an echo above some strength (selectable) is within the alarm range on the screen.

The **bottom lock fish alarm** tells you when fish are within some distance from the bottom. The bottom-lock display must be active to use this alarm.

7.11.1 How to Set an Alarm

1. Press the **MENU** key to open the menu.
2. Select the [Alarms-Fish Finder] menu.
3. Select [Fish Alarm Range] for the fish alarm, or turn on [Fish Alarm for Bottom] to enter the bottom lock alarm range at [Bottom Lock Fish Alarm Range].

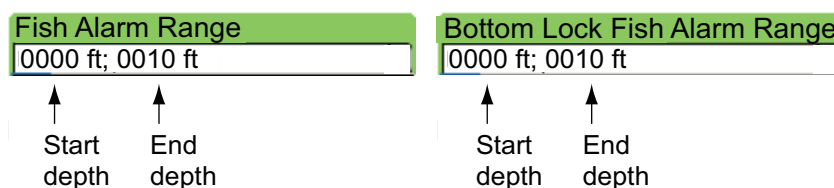

4. Push the **RotoKey** to enter the alarm value.

7. FISH FINDER

- Use the **RotoKey** to set the start depth. Rotate the knob to set numeric then push the key to validate the setting.

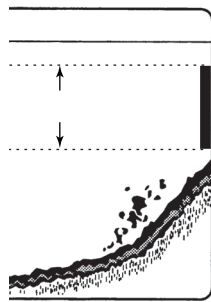
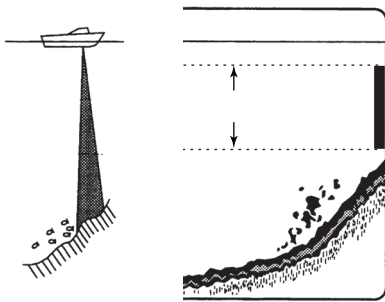

Start depth (from sea surface)
Alarm range marker
End depth (from sea surface)

Scenario for fish alarm

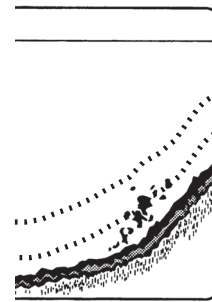

End depth (from bottom)
Start depth (from bottom)

Scenario for bottom-lock alarm

- Set the end depth in the same method.
- Press the **MENU** key to finish.

7.11.2 How to Activate or Deactivate an Alarm

Fish alarm

Push the **RotoKey** to show the soft controls. Select [Fish Alarm] then push the **RotoKey** to activate or deactivate the alarm.

Fish alarm for bottom lock

Open the [Alarm-Fish Finder] menu and turn [Fish Alarm for Bottom Lock] on or off.

7.11.3 Alarm Sensitivity

You can select which strength of echoes to release the fish alarms.

- Press the **MENU** key to open the menu.
- Select the [Alarms-Fish Finder] menu.

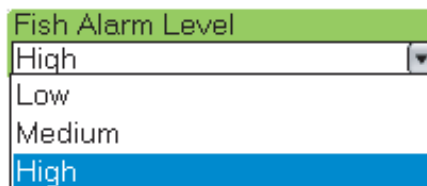

- Use the **RotoKey** to select which echo strength releases the fish and bottom lock alarms. Refer to the description below.
[Low]: Light-blue or stronger echoes
[Medium]: Yellow or stronger echoes
[High]: Red and reddish-brown echoes
- Press the **MENU** key to finish.

7.12 ACCU-FISH™

The ACCU-FISH™ feature estimates the length of each fish and shows a fish symbol and depth value or fish length. This feature requires appropriate transducer and either Network Sounder BBDS1, DFF series or Color LCD Sounder FCV-1150.

Application consideration

- The information given by this feature is intended for reference only.
- ACCU-FISH™ uses both low-and high-frequency echoes for the measurements regardless of the frequency mode in use.
- The intensity of an echo depends on fish species. If the indicated length is different from the true length, you can apply an offset at the [Fish Finder-DFF1/BBDS1/DFF1-UHD, or -DFF3/FCV] menu.
- 50 kHz and 200 kHz beams are transmitted alternately without reference to the current display mode.
- To reduce fish size estimate errors, the detection area must be 2 to 100 meters from the surface.
- This feature cannot be used with the inside-hull transducer since, depending on the transducer frequency, fish may not be detected. Even if fish are detected, the fish length indicated may be smaller than actual length.
- Echoes from a school of fish can be in more than one layer, which can cause wrong length indication.
- Fish symbols are not displayed when the bottom echo does not appear on the screen.

7.12.1 How to Set ACCU-FISH™

1. Press the **MENU** key to open the menu.
2. Open the [Fish Finder-DFF1/BBDS1/ DFF1-UHD, or -DFF3/FCV] menu.
3. Use the **RotoKey** to select [Measurement].



4. Use the **RotoKey** to select [Accu Fish] to activate ACCU-FISH™ or [Off] to deactivate ACCU-FISH™.
5. Select [Fish Info].

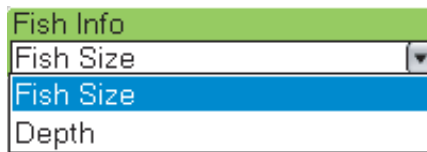

6. Select [Fish Size] or [Depth].

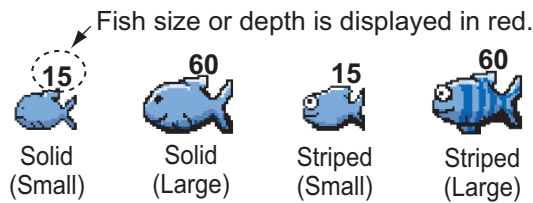

7. Select [Info Size].



8. Select the size for fish info (fish size or depth).
9. Select [Fish Symbols].

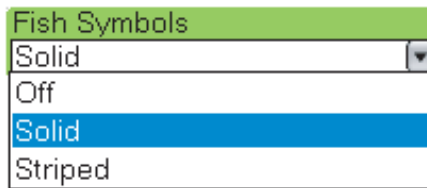

10. Select [Solid], [Striped] or [Off] (turn off fish symbol).

Fish size	Solid	Striped
Large fish symbol (more than 51 cm (20.08 inch))		
Small fish symbol(10 to 50 cm (3.93 to 19.69 inch))		

11. Press the **MENU** key several times to close the menu.

7.12.2 Fish Size Correction

The fish size shown on the display can be different from the true fish. If the size is wrong, add an offset to the measured value to get accurate indication on the screen. Use the **RotoKey** to select [Fish Size Correction] on the [Fish Finder-DFF1/BBDS1/ DFF1-UHD, or -DFF3/FCV] menu. Rotate the **RotoKey** to set correction percentage then push the **RotoKey**. The setting range is -80% to +100%, in intervals of 10.



Setting	Revised size
+100	Two times
+50	1.5 times
-50	1/2
-65	1/3
-75	1/3
-80	1/5

7.13 Water Temperature Graph

The water temperature graph, which requires a temperature sensor, shows the surface water temperature.

The water temperature indication (line) moves across the screen from right to left. The water temperature scale is available in degrees Celsius or Fahrenheit, one of which you can select from the [Global-Units] menu.

To activate or deactivate the water temperature graph, do the following:

1. Use the **RotoKey** to show the soft controls.
2. Select [Temp] then push the **RotoKey** to activate or deactivate the water temperature graph.

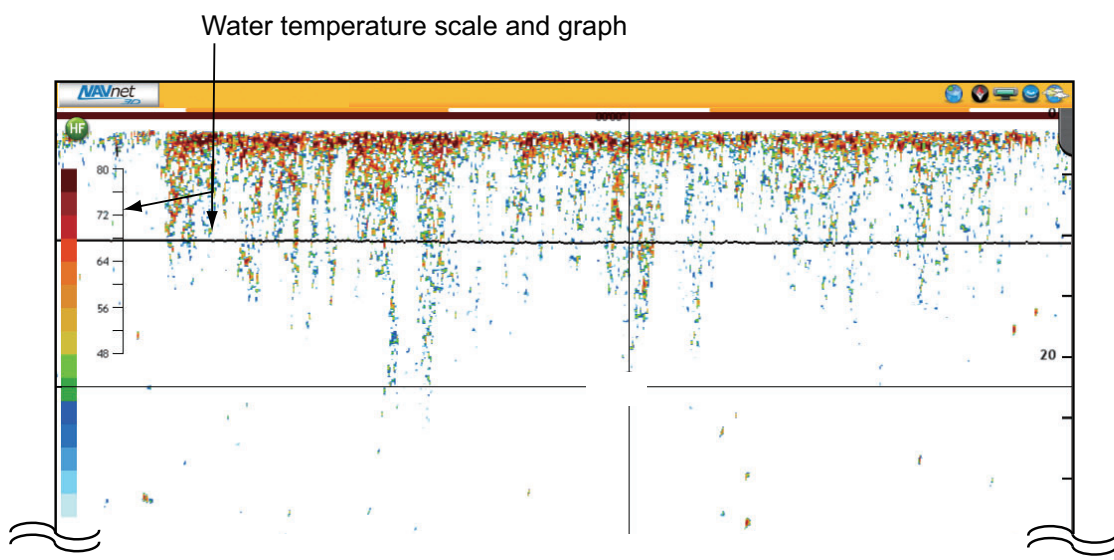

7.14 Fish Finder Menu Operation

This section describes the fish finder functions not described in previous sections.

7.14.1 Fish Finder-General Menu

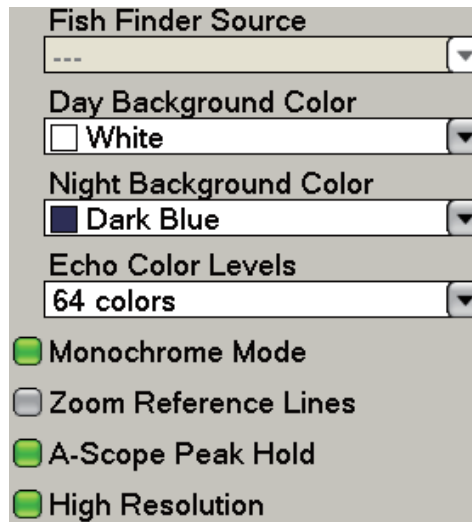

Fish Finder Source: Select the name of the fish finder connected to the network.

Day Background Color: Select the background color for use during daylight hours. The options are black, dark blue, light blue, and white.

Night Background Color: Select the background color for use at nighttime. The options are black and dark blue.

Echo Color Levels: Select the number of colors to shown on the display and the color bar. The selections are 8, 16 and 64 (BBDS1, DFF series, FCV-1150).

Monochrome Mode: Show the echoes in shades of gray.

Zoom Reference Lines: Show or hide the zoom marker, which appears in the bottom zoom and marker zoom modes.

A-Scope Peak Hold: See paragraph 7.2.4 "A-scope Display (display only)".

High Resolution: Turn on this feature to "smooth" echoes when they take on a "jagged" appearance.

7.14.2 Fish Finder-DFF1/BBDS1/DFF1-UHD, -DFF3/FCV, -ETR-6/10N and -ETR-30N Menus

Picture Advance
1/1

Bottom Range Shift Area
67%

Zoom Range Span
030 ft

Bottom Lock Range Span
030 ft

Interference Rejection
Auto

Clutter
0%

Color Erase
0%

White Marker
Off

TVG HF
5

TVG LF
5

Transmit Rate
20

Bottom discrimination
Standard

Mode
4 Color

Bottom disc window

Measurement
Off

Fish Info
Depth

InfoSize
Small

Fish Symbols
Solid

Fish Size Correction
0%

Heaving

DFF1/BBDS1/DFF1-UHD sub menu

Picture Advance
stop

Bottom Range Shift Area

Zoom Range Span
007 ft

Bottom Lock Range Span
007 ft

Interference Rejection
Off

Clutter
0%

Color Erase
0%

White Marker
Off

TVG HF
0

TVG LF
0

Transmit Rate
0

Measurement
Off

Fish Info
Depth

InfoSize
Large

Fish Symbols
Striped

Fish Size Correction
0%

Heaving

DFF3/FCV sub menu

Picture Advance
stop

Zoom Range Span
007 ft

Bottom Lock Range Span
007 ft

Interference Rejection
Off

Clutter
0%

Color Erase
0%

White Marker
Off

TVG HF
0

TVG LF
0

Transmit Rate
0

Range Setup

ETR-6/10N, ETR-30N sub menu

Note: The section below provides only descriptions not previously mentioned.

DFF1/BBDS1/DFF1-UHD, DFF3/FCV, ETR-6/10N, ETR-30N

Bottom Range Shift Area: Select the area where to show the bottom echo, when Auto Range is active. For example, setting 75% would place the bottom echo at a position equivalent to 75% from the top of the display.

Zoom Range Span: Set the zoom range for the bottom zoom and marker zoom displays. The available ranges are as below. DFF1/BBDS1/DFF1-UHD: 7-400 ft, DFF3/FCV-1150: 16-600 ft, ETR-6/10N: 7-400 ft, ETR-30N: 7-600 ft

Bottom Lock Range Span: Set the bottom lock range for the bottom lock display. The available ranges are as below. DFF1/BBDS1/DFF1-UHD: 7-400 ft, DFF3/FCV-1150: 16-600 ft, ETR-6/10N: 7-400 ft, ETR-30N: 7-600 ft.

7. FISH FINDER

Transmit Rate: Change the pulse repetition rate, in 20 levels and Auto. Use 20 (highest power) in normal use. Lower the Tx rate in shallow waters to prevent second reflection echoes that appear between the surface and the bottom echo. Max automatically sets pulse repetition rate and pulse length according to depth. Auto automatically sets the transmit rate according to ship's speed, and is inoperative when there is no speed data.

DFF1/BBDS1/DFF1-UHD, DFF3/FCV

Heaving: When the vessel is in rough seas, the bottom echo and the echoes from fish are not stable, because the distance to the bottom changes. To remove this problem, the SATELLITE COMPASS™ sends pitch and roll data to the fish finder to adjust the Tx and Rx beams. This function requires a FURUNO SATELLITE COMPASS™.

ETR-6/10N, ETR-30N

Range Setup: You can arrange display ranges as desired, from 2-2000 ft. Ranges are set to default whenever the range unit is changed. Set the range unit before changing the preset ranges.

7.15 NavNet 3D and LCD Color Sounder FCV-1150

The FCV-1150 can be connected to your NavNet, and some functions can be controlled from the NavNet. The table shown below shows those features that can be controlled from the NavNet. This feature is available with the FCV-1150 software version 0252359-03.01 or higher.

Function	Controllable from NavNet	Remarks
A-scope	Yes	
ACCU-FISH™	Yes	
Auto gain offset	No	Set at FCV-1150
Background color	Yes	
Bottom detection level	Yes	
Bottom lock range	Yes	
Bottom shift range	No	Set at FCV-1150
Clutter	No	Set at FCV-1150
Color erase	Yes	
Depth unit	Yes	
Draft	No	
Fish alarm	Yes	
Fish info	Yes	
Fish info size	Yes	
Fish level	Yes	
Fish size correction	Yes	
Fish symbol	Yes	
Frequency adjustment	Yes	
Gain	Yes	According to Gain/Mode setting at FCV-1150
Gain offset	No	Set at FCV-1150
Heaving	Yes	
High resolution	Yes	
Interference rejection	Yes	
Manual pulse length	Yes	
Mode	Yes	According to Gain/Mode setting at FCV-1150. NavNet does not have Auto Shift.
No. of echo colors	Yes	
Picture advance	Yes	

7. FISH FINDER

Function	Controllable from NavNet	Remarks
RX band	Yes	
Shift	Yes	
Speed of sound	No	Set at FCV-1150
Split range	Yes	
TX line display, TX line area	No	
TX power		On/Off only
TX pulse length	Yes	
TX rate	Yes	
Water temp. graph	Yes	
White marker	Yes	
Zoom marker	Yes	
Zoom mode	Yes	
Zoom range	Yes	

7.16 Interpreting the Display

Color bar

The color bar at the left edge of the display shows the range of colors used to display different echo strengths. The top color (reddish-brown) is the strongest color and the lower colors the weaker colors. Use the bar as a reference to estimate the density of a school of fish, fish species and the hardness of the bottom.

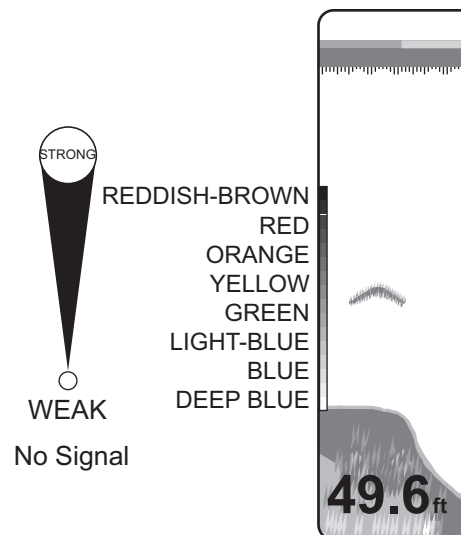

Zero line

The zero line shows the position of the transducer. The line disappears from the screen when the range is shifted, or is shown at the draft depth when the draft of the vessel is entered.

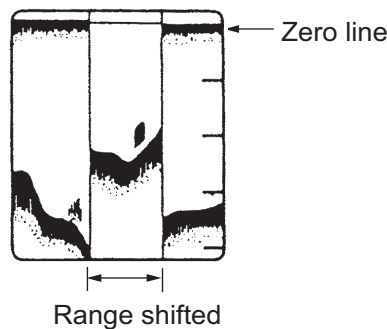

Bottom echoes

The strongest echoes are from the bottom, and are normally shown in reddish-brown or red. The colors and the width change with bottom material, depth, sea condition, installation, frequency, pulse length and sensitivity.

Bottom contour

The tail from a hard bottom is longer than the tail from a soft bottom, because the hard bottom reflects more of the ultrasonic pulse. An echo from shallow water gives a stronger reflection than the echo received from deep water. A longer bottom tail appears on slopes, because of the difference in travel time at both edges of the beam angle. For the rough bottom, echoes are reflected on many different planes, which displays echoes in many layers, which gives a 3D effect.

7. FISH FINDER

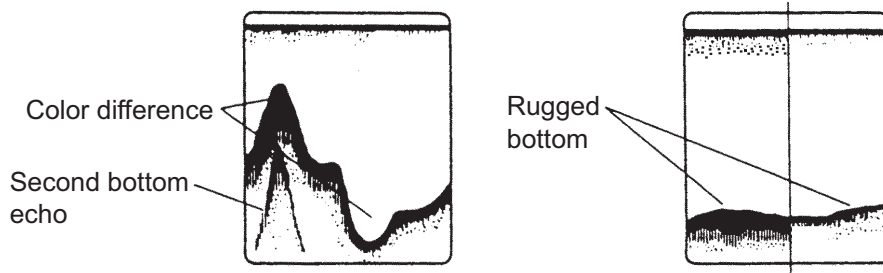

Nature of a bottom

The nature of a bottom is known from the intensity and length of the bottom tail. To find the nature of a bottom, use a long pulse length and normal gain. For the hard and rough bottom, the bottom echo is reddish-brown with a long tail. For the mud or sand bottom, the bottom echo has less red and with a short tail. A bottom with a lot of small particles can give a long tail on the low-frequency picture.

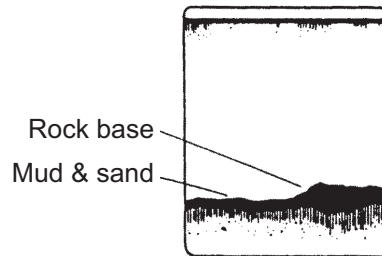

Fish quantity

The size and density of a school of fish are indicators of the quantity of fish.

Size of a school of fish

Usually the size of fish echoes on the screen is proportional to the actual size of the school of fish. However, if two fish echoes appear at different depths with the same size, the school of fish at the shallower depth is smaller because the ultrasonic beam widens as it propagates and a school of fish in deep water is displayed larger.

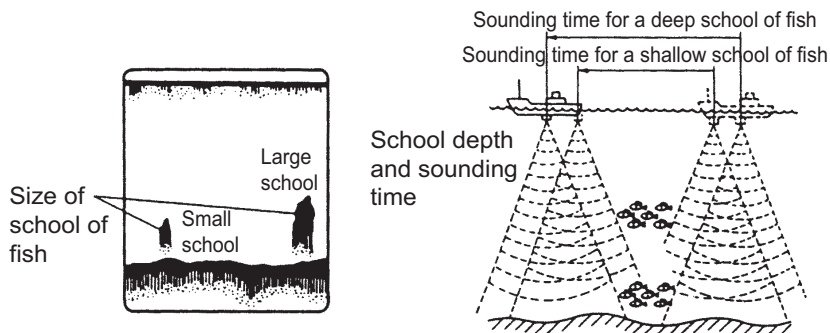

Density of a school of fish

If two schools appear with the same color at different depths, the one in deeper water is denser because the ultrasonic wave attenuates as it propagates and the school of fish in deep water tends to be displayed in a weaker color.

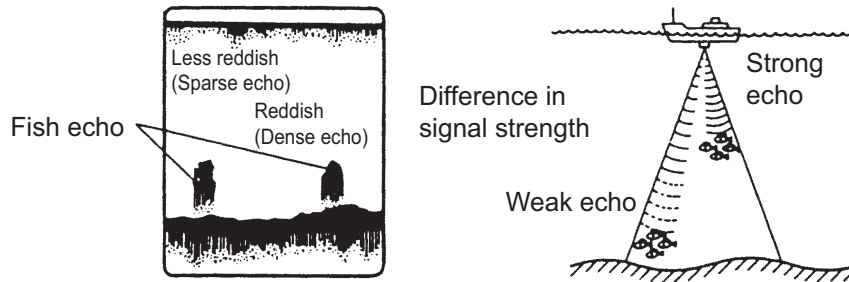

Plankton

A plankton layer appears as a large amount of green or blue dots, and is a possible location for fish. A plankton layer moves down in the day and up at night.

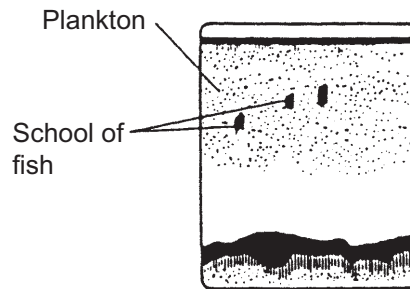

Current rip

When two ocean currents of different speeds directions and water temperatures meet, a current rip occurs. A current rip appears on the screen as shown in the illustration.

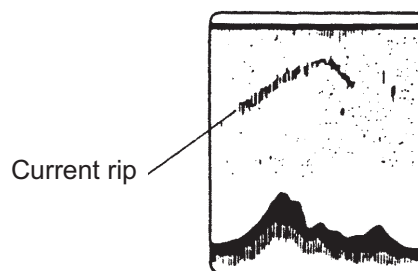

Surface noise

When the sea is rough or the vessel moves over a wake, surface noise can appear at the top of the screen.

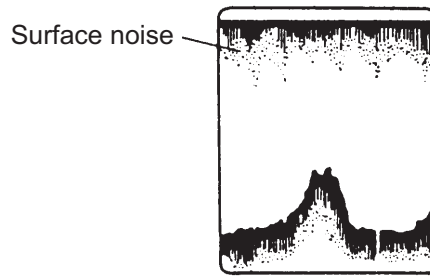

Air bubbles in the water

When the sea is rough or the vessel makes a quick turn, there can be blank spots in the bottom echo. See the illustration. These blank spots are caused by air bubbles which stop the movement of the sound wave. These air bubbles can occur with the low-frequency ultrasonic waves.

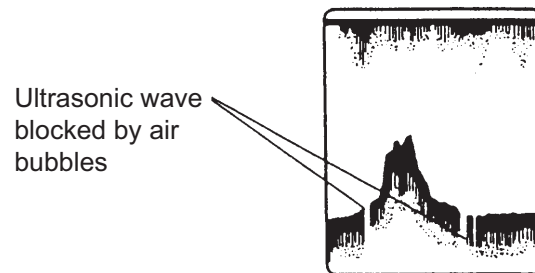

False echo

When an ultrasonic pulse is transmitted, some energy leaves from each side of the beam. This energy has the name "sidelobe". Echoes from sidelobes show on the display as false images like in the illustration shown below.

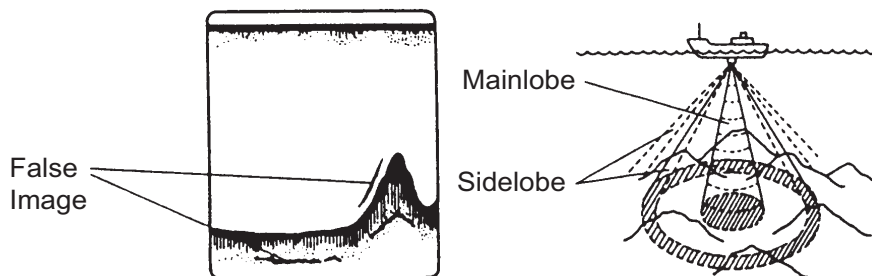

8. FILE OPERATIONS

This chapter covers file operations, using SD cards. Topics include

- How to import tracks, routes, points and user setup
- How to export tracks, routes, points and user setup
- How to manage files on the hard disk and an SD card

Use SD cards whose capacity is 128 MB to 2 GB.

Note 1: The Power LED flashes when the SD drive is being accessed. DO NOT remove the card while the LED is flashing, to prevent loss of data or damage to the card.

Note 2: User setup items cannot be imported or exported between MFD8, MFD12 and MFDBB (and vice versa).

8.1 How to Format SD Cards

You do not need to format SD cards for use with the system. However, if you need to format a card, see the section 1.6 "SD Cards".

8.2 Files Menu Operation

The [Files] menu is where you import and export data.

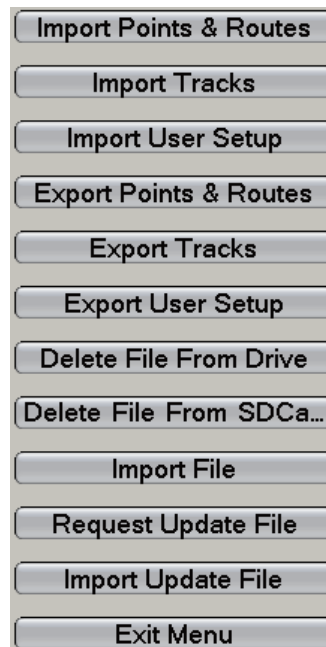

8.2.1 Files Menu Description

Import Points & Routes

Import points and routes from an SD card. When you import points and routes from a SD card, all points and routes currently stored in the MFD are replaced with those on the SD card.

Import Tracks

Import track from an SD card. Use this function to create a route using past tracks. Like with Import Points & Routes, imported tracks are displayed with current tracks. Any track data which have the same is written over with the track data on the SD card.

Import User Setup

This feature imports user settings (all menu settings) from a SD card to the hard disk. The current user settings are written over.

Export Points & Routes

This unit holds 2,000 points and 200 routes in its hard disk. When the capacity for points or routes are reached, a new point or route cannot be entered unless an unnecessary point or route is erased. For those reasons, export points and routes you need to save to an SD card.

Export Tracks

This unit holds 10,000 points of tracks. When that total is reached, the oldest track is deleted to get room for the latest track. If you require the track, save it to an SD card.

Export User Setup

Export user settings to an SD card. This feature helps you set another multi-function display with the same settings on the SD card.

Delete File from Drive

Delete unnecessary files from the hard disk.

Delete File from SD Card

Delete unnecessary files from an SD card.

Import File

This feature is not used on this equipment.

Request Update File

This feature is not used on this equipment.

Import Update File

This feature is not used on this equipment.

8.3 How to Export Tracks, Points and Routes, User Setup

When the capacity for track is reached, the oldest track is erased to clear space for new track. Points and routes cannot be entered when their related memories are full. If you need to save track, points and routes permanently, save them to a SD card. You can also save user settings to a SD card to use the settings on other MFD units.

1. Put a blank formatted SD card in either card slot.
2. Press the **MENU** key to open the menu.
3. Open the [Files] menu.
4. Select [Export Tracks], [Export Points and Routes] or [Export User Setup]. The screen shown below appears.

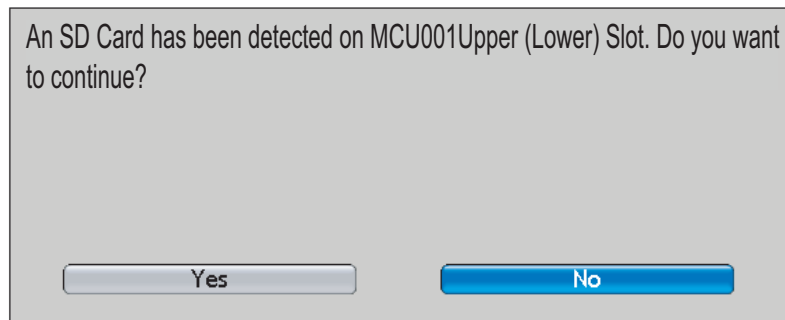

5. Rotate the **RotoKey** to select [Yes] then push the key. For Points and Routes or User Setup, enter a filename. For track, select a track file.

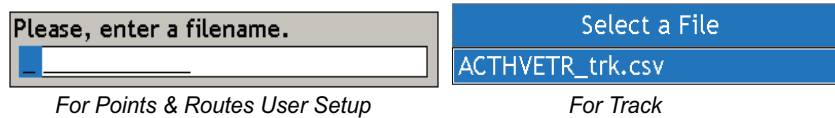

6. Do one of the following:
 - Points and Routes, User Setup:** Use the **RotoKey** to enter a file name. Push the **RotoKey** to validate.
 - Track:** Use the **RotoKey** to select the track file to export. Push the **RotoKey** to validate. After the file is exported, the message “[file name] is exported” appears; push the **RotoKey** to finish.
7. After the equipment has exported the selected item, press the **MENU** key to close the menu.

8.4 How to Import Tracks, Points and Routes, User Setup

You can import tracks, points, routes and user setup to the hard disk of a NavNet unit. Use this feature to use the same data across the NavNet network.

1. Put the correct SD card in either card slot.
2. Press the **MENU** key to open the menu.
3. Open the [Files] menu.
4. Select [Import Tracks], [Import Points and Routes] or [Import User Setup].
5. Rotate the **RotoKey** to select [Yes] then push the key.
6. A list off related files appears. Rotate the **RotoKey** to choose the file to import then push the key to import the selected file.
7. After the equipment has imported the selected item, press the **MENU** key to close the menu.

8.5 How to Delete Files

You can delete unnecessary tracks, routes, points and user setup data from the hard disk and a SD card.

1. Put the SD card which contains the file to delete into a card drive.
2. Press the **MENU** key to open the menu.
3. Open the [Files] menu.
4. Select [Delete File from Drive] or [Delete File from SDCard]. If you selected [Delete File from SDCard] you are asked to continue. Use the **RotoKey** to choose [Yes].

Files stored on the hard disk or SD card appear, and the file lists looks like those shown below.

Select a File	Select a File
ACTHVETR_trk.csv	ACTHVETR_trk.csv
QQQQ_grp.csv	Engineer_disp.bin
QQQQ_rte.csv	Engineer_etr.bin
QQQQ_twp.csv	Engineer_rad.bin
QQQQ_wpt.csv	UK_Lymington.nnd
SETUP1_stp0.bin	US_CapeCod.nnd
SETUP1_stp1.bin	
SETUP1_stp2.bin	
SETUP2_stp0.bin	
SETUP2_stp1.bin	
SETUP2_stp2.bin	

Files on SD card

Files in the hard drive

5. Use the **RotoKey** to select the file to delete then push the **RotoKey**.

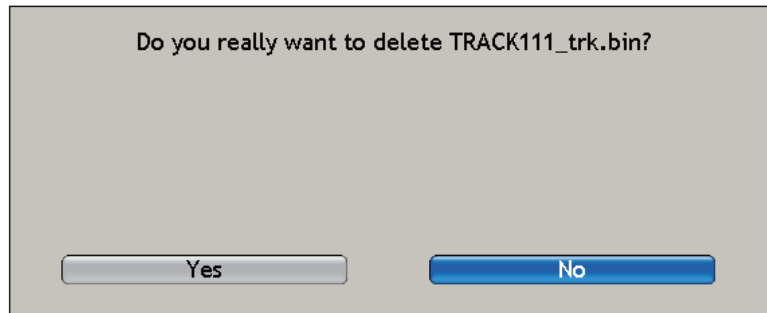

6. Rotate the **RotoKey** to select [Yes] then push the key to delete the selected file.
7. Press the **MENU** key to close the menu.

8. FILE OPERATIONS

This page is intentionally left blank.

9. CAMERA/VIDEO

The camera/video function allows you to use your unit to play back images from a video player, on-board camera, network camera or DVD player. Network camera images can be seen across the NavNet 3D network. A video signal can be seen only on the MFD that receives the video signal.

A maximum of four IP cameras can connect to the Navnet system and the images from two can be shown on the screen. You can monitor the images from two cameras on the full screen or the 1/4 screen. You can also set the video application to show the display of each video in turns. Further, you can also adjust the brightness, contrast and color of each image.

9.1 How to Display a Video Image

The camera application is included in the default display selection window. Press the **DISP** key to show the display selection window. Rotate the **RotoKey** to select the Camera Display then push the key to validate your selection.

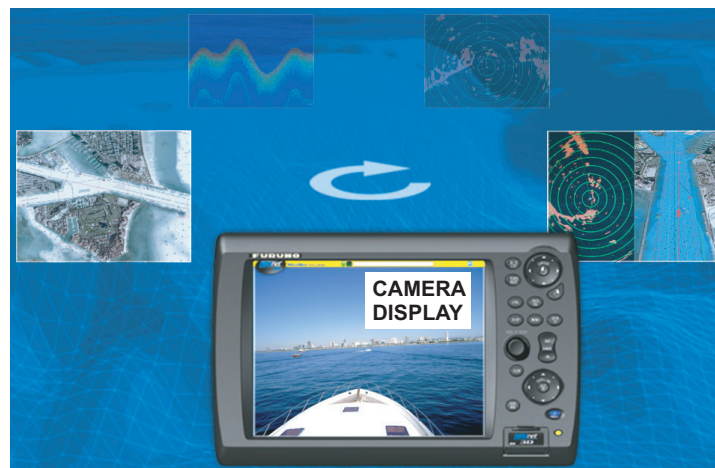

9.2 How to Set the Video Display

9.2.1 How to Select the Input Source

You can select the input source from the menu or with the **RotoKey**. Below is the procedure with the **RotoKey**.

1. Activate the camera mode then push the **RotoKey**.
2. Rotate the **RotoKey** to select [Vid Source] then push the **RotoKey**. The selections are as follows:
3. Select each input source (Input1 - Input2).
4. Push the **RotoKey** to select or deselect the input.

9.2.2 How to Cycle Your Video Inputs

You can browse all the images that you receive. Use this feature to monitor the area around your vessel, engine room, etc. with an on-board camera.

1. Press the **MENU** key.
2. Open the [Camera] menu.
3. Use the **RotoKey** to select [Scrolling Cycle 1].

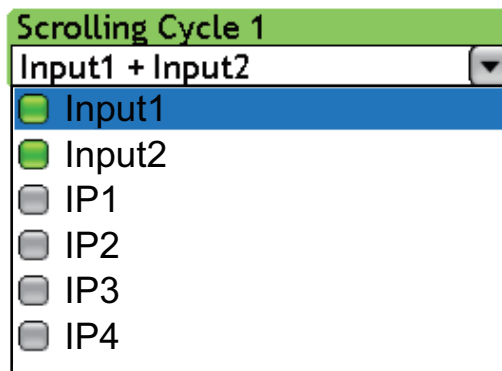

4. Use the **RotoKey** to select the inputs to cycle.
5. Set up [Scrolling Cycle 2] similarly.
6. Press the **MENU** key to close the menu.

To select the cycle, show the soft controls, use the **RotoKey** to select [Vid Cycle] then select [Cycle 1] or [Cycle 2] as appropriate.

9.2.3 How to Set the Cycle Period

The default cycle period is five seconds. The cycle times of 10 and 30 seconds are available also.

1. Press the **MENU** key.
2. Open the [Camera] menu.
3. Use the **RotoKey** to select [Time Interval].

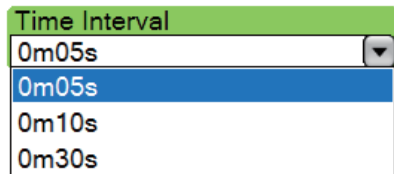

4. Use the **RotoKey** to select a time interval.
5. Press the **MENU** key to close the menu.

9.3 How to Show Video ID

You can show video ID at the top-left corner. Use the **RotoKey** to select [Video ID] then push the key to show or hide the video ID.

9.4 How to Adjust the Video Image

1. Long-push the **RotoKey** to show the soft controls that adjust the video signal.

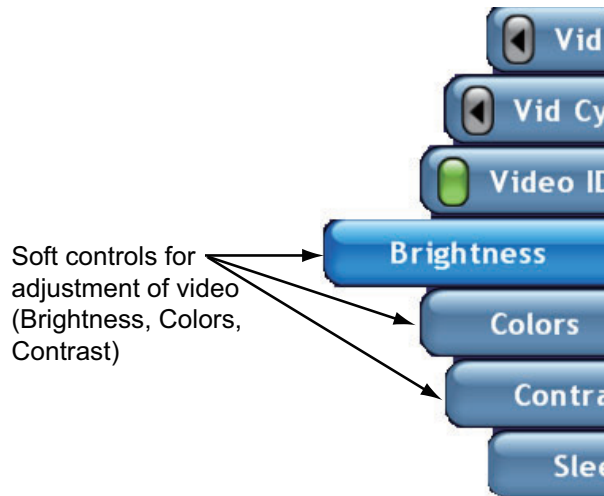

2. Rotate the **RotoKey** to select [Brightness], [Colors] or [Contrast] then push the key.

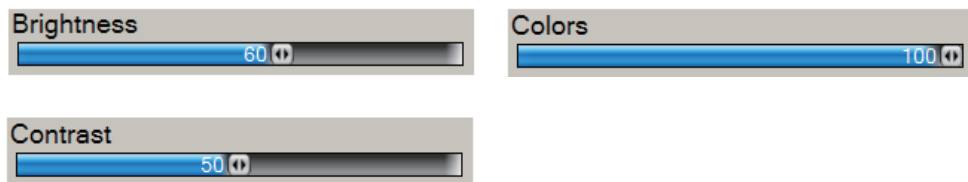

3. Rotate the **RotoKey** to adjust the slider bar then push the key to validate your setting.

9.5 How to Control an Axis IP Camera

An AXIS IP camera can be controlled from the NavNet display. Use the RANGE control to zoom in or zoom out. Scroll the camera image with the ScrollingPad.

10. INSTRUMENT DISPLAY

The instrument display gives you a maximum of five navigation and environment displays:

- Engine
- Steering
- True wind
- Apparent wind
- True wind and weather

In the default arrangement, the instrument display is available when the number of hot pages (display selections) is nine or ten. (Select the number of hot pages on the on the [My NavNet-General] menu. The instrument display can also be programmed to a three-way or four-way split screen, and a maximum of four displays can be shown at the same time. (The size of any instrument display is fixed to the 1/4 screen.)

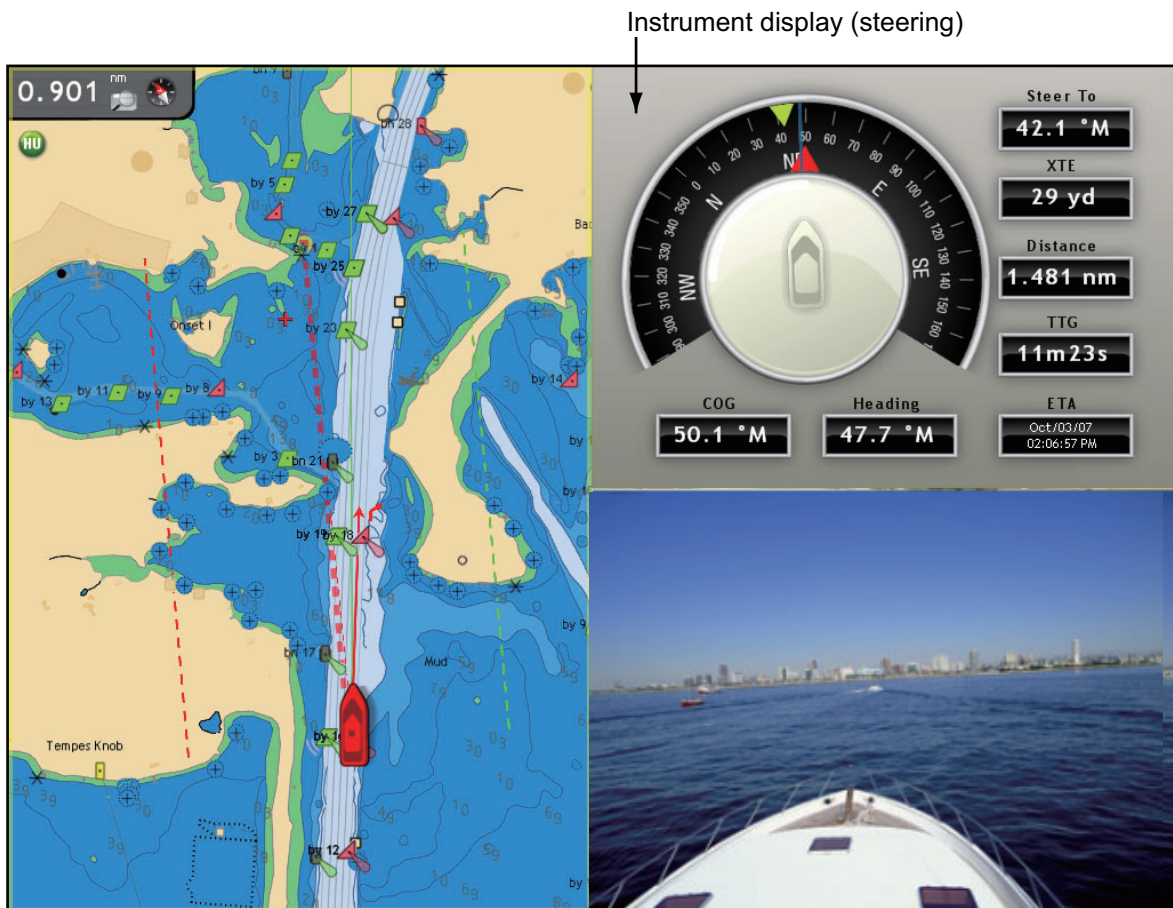

Instrument display (steering)

10.1 How to Prepare the Hot Page

The instrument display is available when the number of hot pages in the display selection window is nine or ten. Select the number of hot pages to display as in the procedure shown below.

1. Press the **MENU** key to open the menu.
2. Open the [My NavNet-General] menu.
3. Use the **RotoKey** to select [Hotpage Number].

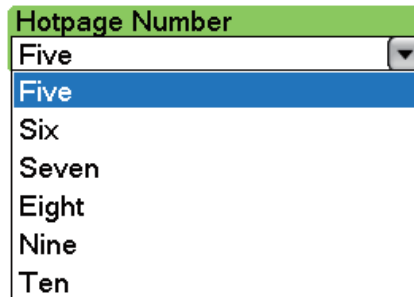

4. Use the **RotoKey** to select [Nine] or [Ten] to get the instrument display.
5. Press the **MENU** key to close the menu.

10.2 How to Show the Instrument Display

Press the **DISP** key to show the display selection window. Rotate the **RotoKey** to select the combination display which contains the instrument display. Push the **RotoKey** to show the selected display.

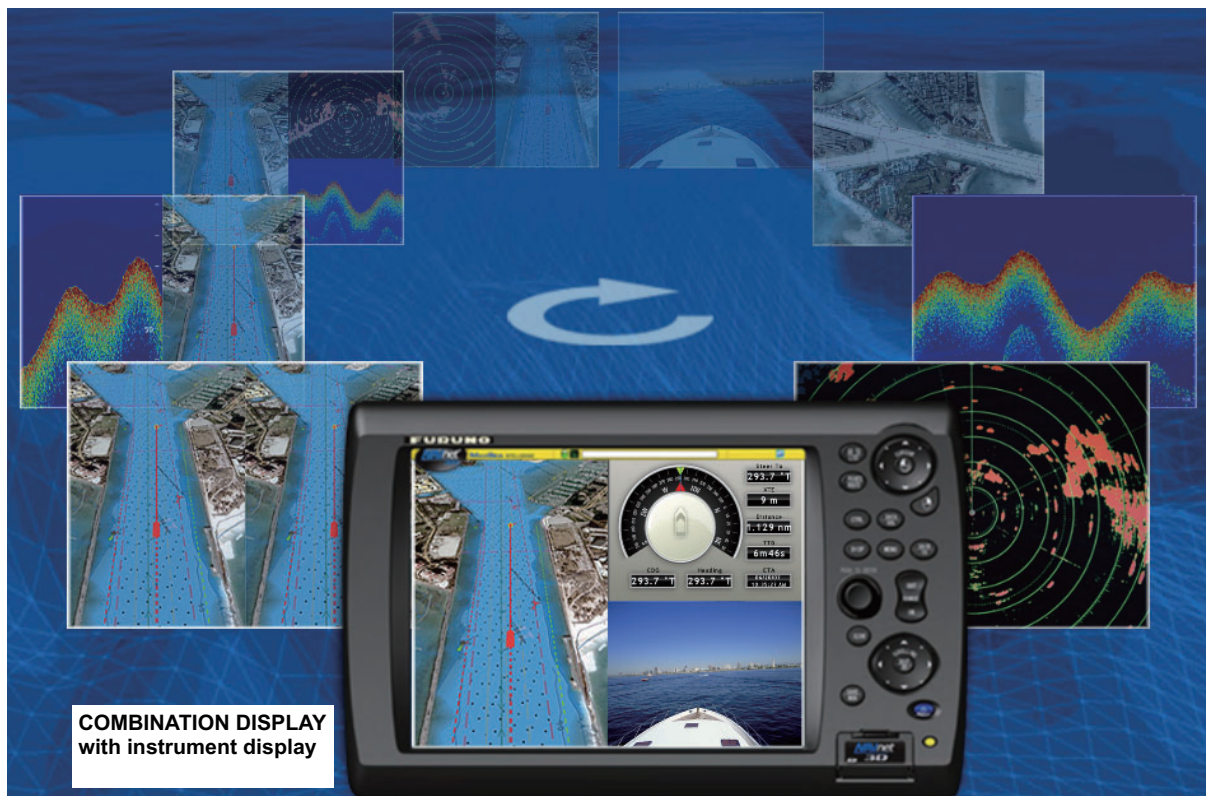

10.3 How to Select an Instrument Display

You can show engine, steering, wind or wind/weather data in the instrument display if you have the related sensors. Select the data to display as follows:

1. Activate the instrument display then push the **CTRL** key to select the instrument display with the yellow cursor.
2. Push the **RotoKey** to show the soft controls that select an instrument display.
3. Rotate the **RotoKey** to select a display then push the key to validate your selection.



10.4 Instrument Displays

10.4.1 Steering Display

The steering display provides the analog and digital indications shown below.

- Heading
- Direction to steer
- Cross-track error
- Distance to destination waypoint
- Time To Go to destination waypoint
- Estimated Time of Arrival at destination waypoint
- Course over ground

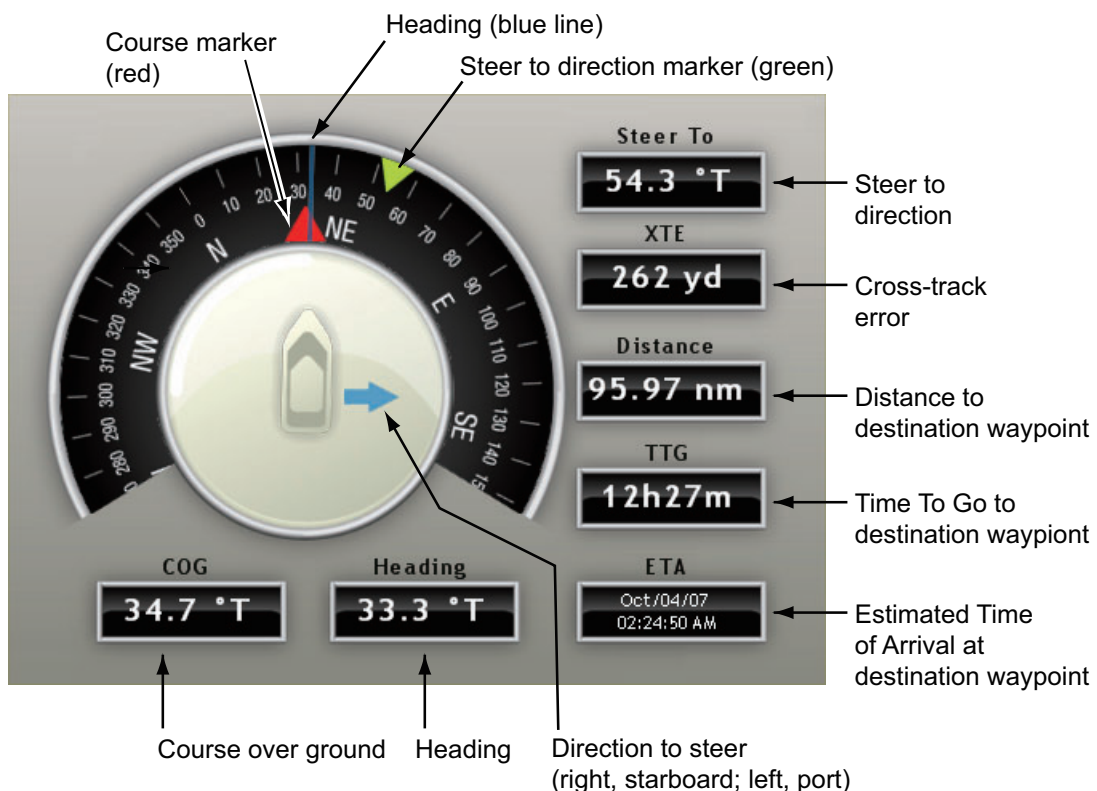

10.4.2 Engine Display

The engine display shows the information listed below. The engine must output engine data in NMEA 2000 format to show the engine data.

- Abnormal engine temperature and engine trouble lamps
- Tachometer
- Oil pressure
- Engine temperature
- Boost pressure

Engine-related warning lamps

Temp (green): Lights for high engine temperature.

Warning (red): Lights for engine trouble or than high temperature.

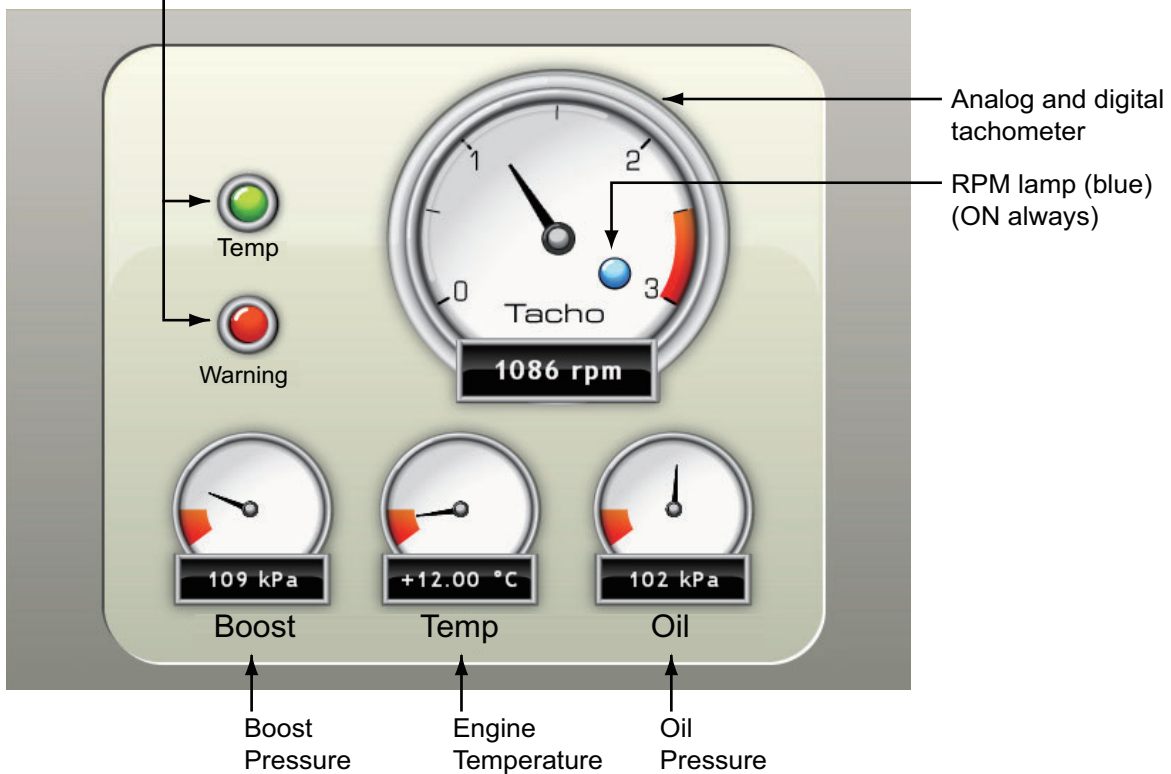

Engine-related warning lamps

- Both lamps flash when there is no engine data for approx. 30 seconds.
- Both lamps light at power-up if there was no engine data when the power was turned off.

10.4.3 Wind and Weather Display

The wind and weather display shows

- Wind direction
- Air temperature
- Wind chill temperature
- Dew point temperature
- Barometric pressure
- Relative humidity
- Wind speed and direction

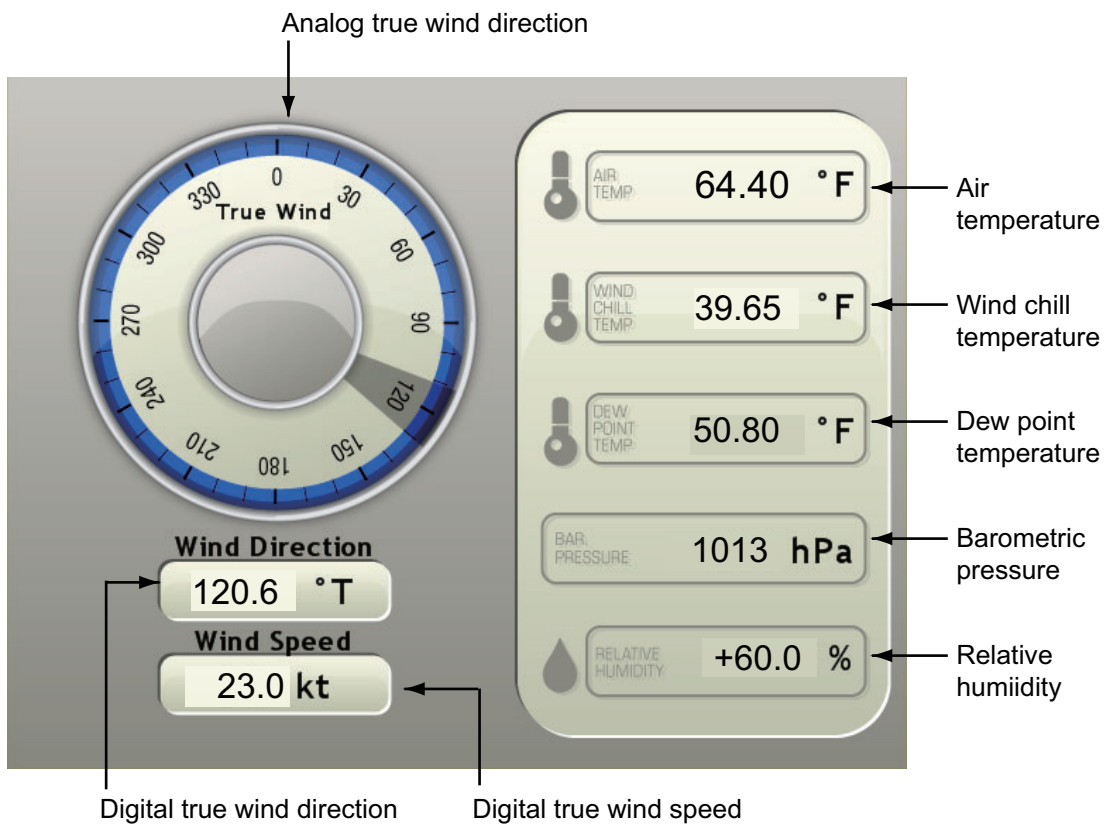

10.4.4 True Wind Display

The true wind display provides digital and analog indications of true wind speed and angle, and heading.

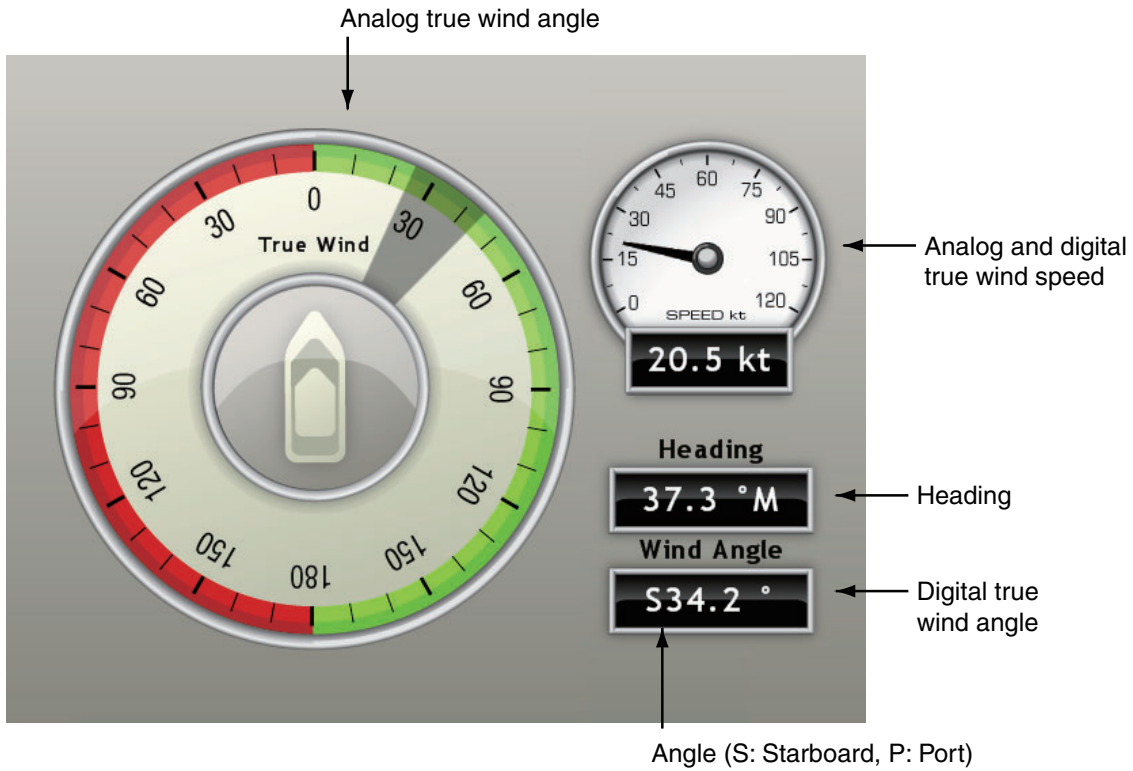

10.4.5 Apparent Wind Display

The apparent wind display provides digital and analog indications of apparent wind speed and angle, and heading.

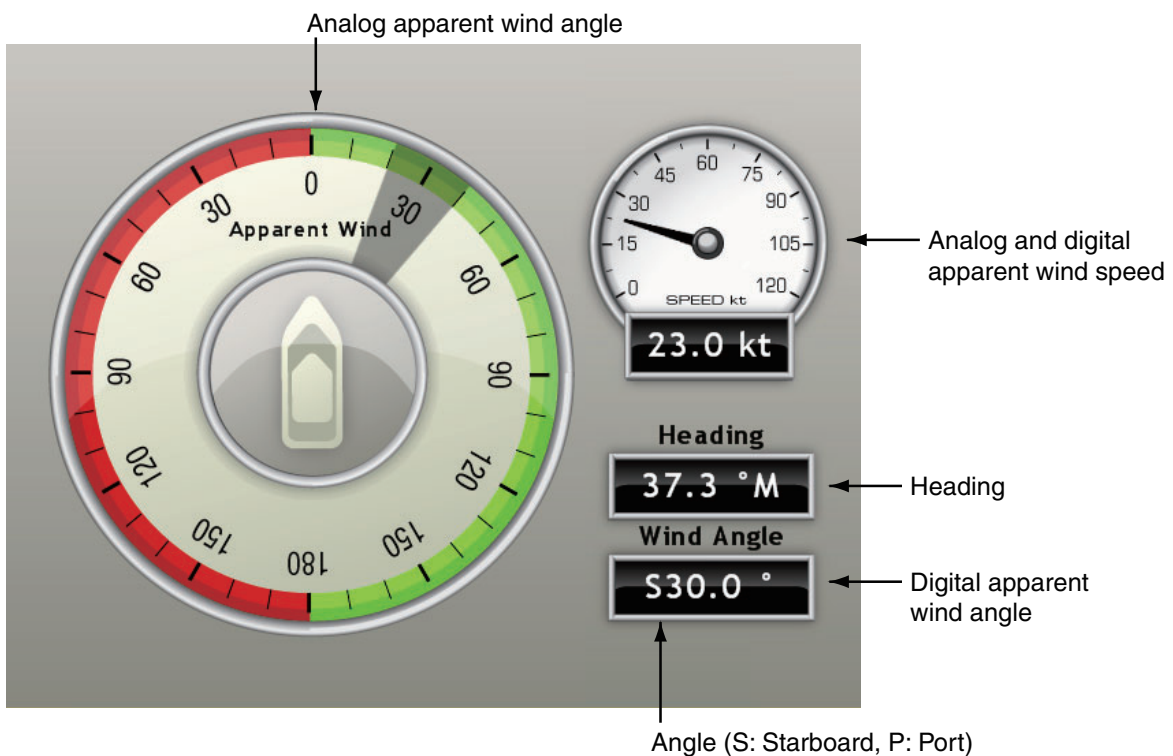

11. SIRIUS WEATHER RECEIVER

When connected to the Sirius Weather Receiver BBWX1, this MFD provides the weather information for your area and Sirius satellite radio services.

Before you use the weather application:

- Purchase the Sirius Weather Receiver BBWX1.
- Purchase a Sirius weather service subscription. Contact Sirius Satellite Radio INC., for additional information.
- Connect the BBWX1 and the MFD displays then turn on both of those units. Your MFD then receives WX data from the BBWX1, which takes approximately 30 minutes.
- During the installation of the equipment, the Installation Wizard checks if the BBWX1 is connected to the MFD. If the MFD cannot find the BBWX1, check the connections between the two units.









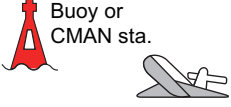

11.1 Weather Display Introduction

This MFD displays the current and forecasted weather information for your area. The weather information is updated in real time so that you have current weather information for your area and any area in the U.S.

Information provided by the Sirius Marine Weather service is advisory in nature only. You, the customer, agree to release FURUNO ELECTRIC CO., LTD., Sirius Satellite Radio Inc., Navcast Inc. and WSI Corporation from any problems that occur from this service. And you acknowledge that you have read the conditions of your subscription agreement and agree to all the conditions of the subscription. If you do not have the subscription agreement, got to www.sirius.com/marineweatheragreement or call 1-800-869-5480 to have a copy sent to you.

11.2 Weather Icons

The table below shows the weather icons that appear on the Sirius Satellite Weather display. You can show or hide these icons from the [Weather] menu.

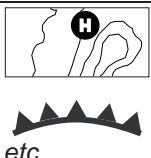
Icon	Color	Meaning
	Pink	Storm cast
	Dark yellow (recorded in last 0-5 min.) Medium yellow (recorded in last 5-10 min.) Light yellow (recorded in last 10-15 min.)	Lightning
 Buoy or CMAN sta.	Buoy: Red CMAN station: Grey Airplane: White	Surface observation stations
	Pink	Wind
	Grey	Cities
	Dark blue	Waves
	Green-red	CANRAD (Canadian radar)
	Red-blue	Sea surface temperature
	Green (Rain) Blues (Snow) Pinks (Mixture)	NOWRAD (USA RADAR)
	Grey (Historical) Red (Current) Orange (Forecast)	Storm tracks
 etc.	For details, see page 11-6.	Surface pressure

11.3 Weather Menu

The [Weather] menu adjusts the following weather-related items:

- Overlay transparency
- Color scale
- Weather radar (US or Canada)
- Standard weather data
- Advanced weather data

11.3.1 How to Display the Weather Menu

1. Press the **MENU** key to open the menu.
2. Use the **RotoKey** to open the [Weather-Sirius] menu.

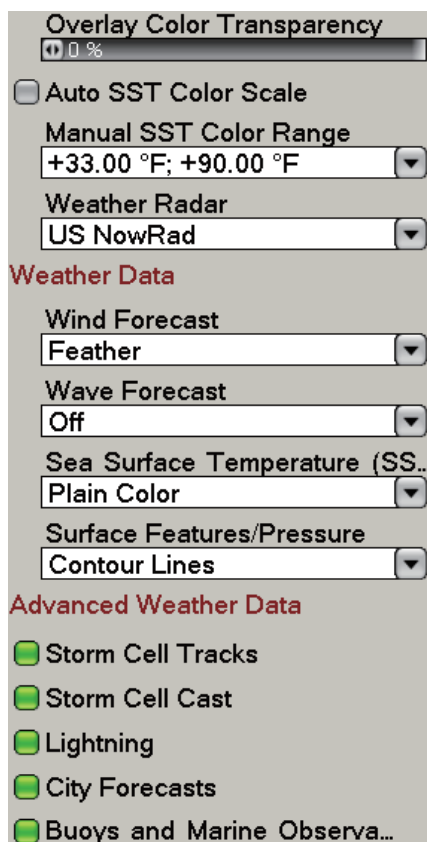

3. Use the **RotoKey** to select the weather item to show or hide.
4. Push the **RotoKey** to show or hide the item.
5. Press the **MENU** key to close the menu.

11.3.2 Weather Menu Description

You can show sea surface temperature (SST), wave forecast and wind forecast together on the full screen display. In the split window configuration, only one can be displayed on either screen. Only one of the three can be shown in “plain color” when all three are displayed, and SST has priority.

Overlay Color Transparency

Adjust the level of transparency for the weather overlay. Select this item with the **RotoKey** then push the **RotoKey**. Rotate the **RotoKey** to set then push the key to validate your setting. Use a large figure to increase the level of transparency.

Auto SST Color Scale

Activate this feature to adjust the SST color scale automatically according to sea surface temperature.

Manual SST Color Range

Set the SST color range when Auto SST Color Scale is deactivated. The setting range is +00.00 to 99.99 (degrees Fahrenheit).

Weather Radar

Select the weather radar to use, USA NOWRAD (USA) or CANRAD (Canada). NOWRAD shows the type and level of precipitation. The amount of precipitation increases with level.

Precipitation indication on NOWRAD.

Weather radar color	Precipitation type	Level
Light green	Rain	15-19 dBz
Medium green	Rain	20-29 dBz
Dark green	Rain	30-39 dBz
Yellow	Rain	40-44 dBz
Orange	Rain	45-49 dBz
Light red	Rain	50-54 dBz
Dark red	Rain	over 55 dBz
Light blue	Snow	5-19 dBz
Dark blue	Snow	over 20 dBz
Light pink	Mixed	5-19 dBz
Dark pink	Mixed	over 20 dBz

Precipitation indication on CANRAD

Weather radar color	Level (mm per hour)
Transparent (low precipitation)	0.00 to 0.20 mm/hr
Light green	0.21 to 1.00 mm/hr
Medium green	1.01 to 4.00 mm/hr
Dark green	4.01 to 12.00 mm/hr
Yellow	12.01 to 24.00 mm/hr
Orange	24.01 to 50.00 mm/hr
Light red	50.01 to 100 mm/hr
Dark red	over 100.01 mm/hr

Weather Data

Wind Forecast

Select how to show the wind forecast. There are two types of wind icon styles: Vane feathers and Plain colors. Vane feathers also show you wind speed and direction, but give you more information about the wind speed per the description shown below.

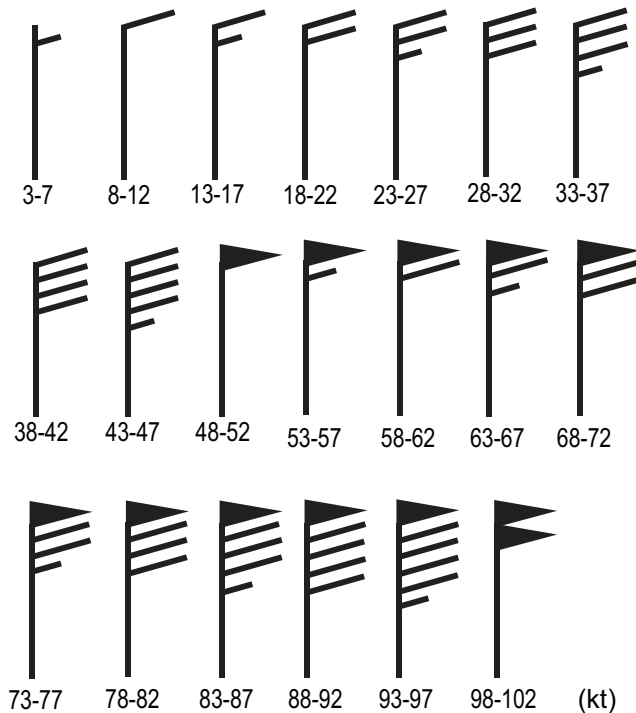

Object Detail	
Wind Force	10.0 kt
Wind Direction	306.5 °M
Wave Height	+11.0 ft
Wave Direction	141.5 °M
Wave Period	0m00s

Put cursor on a wind icon or anywhere on a body of water. Press the **left-click** button to show wind and wave information for that area.

Waves Forecast

The Waves forecast displays wave height with a dark blue arrow. The length of the arrow increases with the height of the wave. To find the wave information, put the cursor on a wave symbol and press the **left-click** button.

Object Detail	
Wind Force	30.0 kt
Wind Direction	186.5 °M
Wave Height	+12.50 ft
Wave Direction	156.5 °M
Wave Period	0m00s

Sea Surface Temperature

This data layer shows the temperature of the sea surface in shades of red and blue. Lower temperatures are in blue.

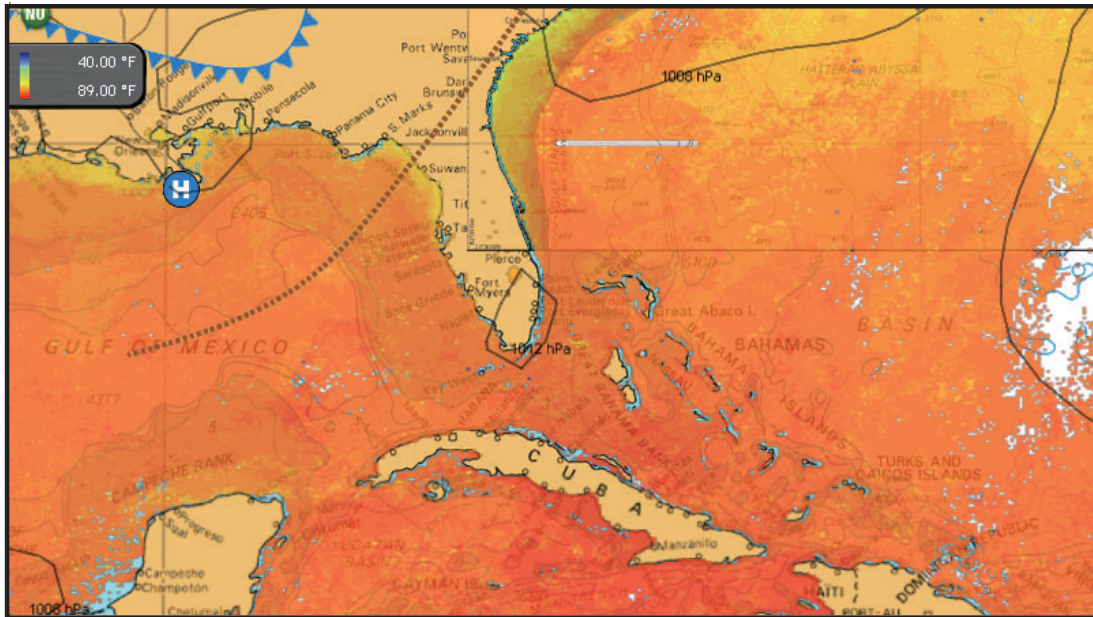

Surface Features/Pressure



Activate this feature to get surface pressure with meteorological symbols. Put the cursor on a surface pressure icon to show the name of the surface pressure.

Seasurface temp icon	Color	Meaning
	Blue	High pressure
	Red	Low pressure
	Red	Warm front
	Blue	Cold front
	Purple	Occluded front
	Red-blue	Stationary front
	Brown	Trough
	Red	Squall line
	Brown	Dry line
	Grey	Isobars

Advanced Weather Data

Storm Tracks

The storm track icons show major storms in your area. These storms include tropical disturbances, depressions, storms and cyclones, hurricanes, typhoons and super typhoons. These symbols are displayed in three different colors: Grey, historical; Red-current, and Orange, forecast.

Storm tracks icons	Meaning
	Hurricane (Category 1-5)
	Tropical storm
	Tropical disturbance, Tropical depression

To find simple storm tracks information, put the cursor on the icon. For additional information, press the **left-click** button.

Type	Typhoon
Wind Speed	8.0 kt
True Direction	111.5 °M
Wind Gust Speed	35.0 kt
Max Wind Speed	25.0 kt
Pressure	1008 hPa
Track Position Type	Current
Date of Observation	Oct/12/06
Position	17°36.0000' N; 121°54.0000' W

Simple storm tracks information

Object Detail	
Name	OLIVIA
Type	Typhoon
Wind Speed	8.0 kt
True Direction	111.5 °M
Wind Gust Speed	35.0 kt
Max Wind Speed	25.0 kt
Pressure	1008 hPa
Track Position Type	Current
Date of Observation	Oct/12/06
Position	17°36.0000' N; 121°54.0000' W

Detailed storm tracks information

11. SIRIUS WEATHER RECEIVER

Storm Cell Cast

You can find the direction and speed of a storm when you put the cursor on the icon. For additional information, press the **left-click** button.

Speed	14.0 kt
True Direction	66.0 °T
Position	24°29.2800' N; 82°59.8800' W

Simple storm cell cast information

Object Detail	
Speed	20.0 kt
True Direction	81.0 °T
Date of Observation	Dec/18/07
Echo Top	+25000.00 ft
Type	Unknown
Position	24°32.4000' N; 83°15.5400' W

Detailed storm cell cast information

Lightning

The lightning icons show where lightning has hit, within the last 5, 10 and 15 minutes. The fill color of the icon indicates when the lightning hit occurred. See the table below for color and period. The number of lightning bolt markers indicates the number of times lightning has hit.

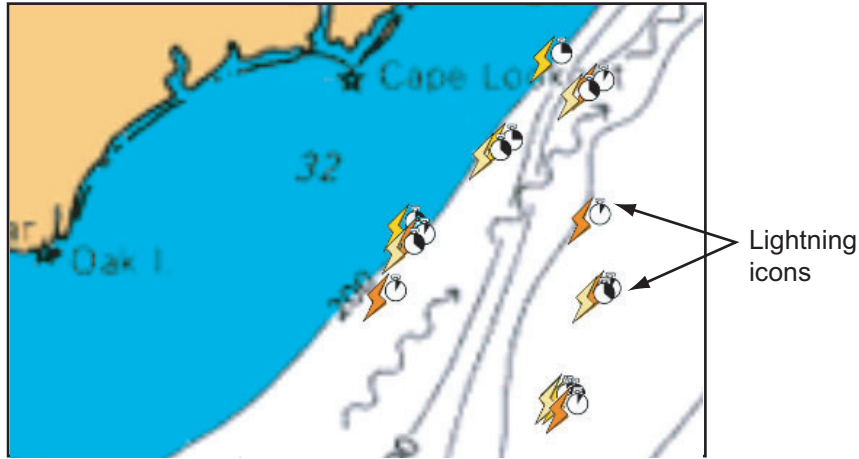

Description of lightning icons

Lightning icon	Color	Period
	Orange	Last 0-5 min.
	Medium yellow	Last 5-10 min.
	Light yellow	Last 10-15 min.

To find simple lightning information, put the cursor on a lightning icon. For additional information, push the **left-click** button.

Period 0 - 5 minutes
Position 39°48.6000' N; 112°10.2000' W

Simple lightning information

Object Detail

Period 0 - 5 minutes
 Position 40°40.8000' N; 109°31.8000' W

Detailed lightning information

City Forecasts

The city weather forecasts are available where city icons are shown. For simple information, put the cursor on the city icon (). For additional information, push the **left-click** button.



Simple city information

Object Detail

Name Sacramento, CA

Thursday
Considerable clouds this morning. Some decrease in clouds later in the day. High 68F. Winds SW at 5 to 10 mph.

Thursday night
Some clouds. Low near 40F. Winds SSW at 5 to 10 mph.

Friday
Intervals of clouds and sunshine. High 68F. Winds SW at 5 to 10 mph.

Detailed city information

Buoys

You can check the historical or current weather information at buoys. For simple information, put the cursor on the buoy icon (). For additional information, press the **left-click** button.

Type **Buoy**
 Position **36°48.0000' N; 121°54.0000' W**

Simple buoy information

Object Detail	
Name	
Type	Buoy
Date of Observation	Mar/08/07
Ship Speed	0.0 kt
Ship Direction	0.0 °T
Wind Speed	5.8 kt
Wind Direction	80.0 °T
Wind Gust Speed	9** kt
Wind Speed At 10 Meters	5.1 kt
Wind Speed At 20 Meters	5.1 kt
Peak Wind Date	---
Peak Wind Dir	255.0 °T
Peak Wind Speed	9** kt
Variable Wind First Dir	255.0 °T
Variable Wind Second Dir	255.0 °T
Water Tmp	54.23 °F
Air Tmp	48.11 °F
Dewpoint Tmp	5**.* °F
Max Tmp in last 24 hours	5**.* °F
Max Tmp in last 6 hours	5**.* °F

↓ Scroll for more data

Detailed buoy data

11.4 Weather Reports

Marine zone forecasts, marine warnings, tropical information and weather alerts are sent to your MFD. You can see those items on the [Weather] menu when you open the related sub menu.

Sirius sends warning messages to tell you about bad weather. You can see these messages when you open the [Weather-Alert] Box menu.

11.4.1 Marine Zone Forecast

These forecasts cover the areas listed below, and is available on ranges shorter than 32 nautical miles

- US coastal weather forecasts
- US offshore forecasts
- High seas forecasts
- Great Lakes forecasts
- Near Shore forecasts
- Canadian coastal weather forecast.

```
Waters from Cocoa Beach to Jupiter Inlet FL from
20 to 60 NM

CWFMLB
AMZ575-032245-
SYNOPSIS FOR FLAGLER BEACH TO JUPITER INLET OUT 60 NM-
422 AM EST SAT FEB 3 2007
.SYNOPSIS...A COLD FRONT WILL STALL OVER SOUTH FLORIDA AND THE
FLORIDA STRAITS TODAY. HIGH PRESSURE WILL REMAIN NORTH OF THE
AREA THROUGH MID WEEK.
.GULF STREAM HAZARDS...NORTH WINDS 15 TO 20 KNOTS.
THE APPROXIMATE LOCATION OF THE WEST WALL OF THE GULF STREAM AS
OF SATURDAY FEB 2 AT 4 AM...
38 NAUTICAL MILES EAST OF PONCE INLET.
24 NAUTICAL MILES EAST OF PORT CANAVERAL.
18 NAUTICAL MILES EAST OF SEBASTIAN INLET.
11 NAUTICAL MILES EAST OF FORT PIERCE INLET.
/O.ROU.KMLB.MA.F.0000.000000T0000Z-000000T0000Z/
WATERS FROM COCOA BEACH TO JUPITER INLET 20 TO 60 NM OFFSHORE-
422 AM EST SAT FEB 3 2007
.TODAY...NORTH WINDS 15 TO 20 KNOTS. SEAS 3 TO 4 FEET. CHANCE OF
RAIN.
```

Marine zone forecast

11.4.2 Marine Warning

Display the marine warnings (US coastal or near shore).

```

Waters from Cocoa Beach to Jupiter Inlet FL from
20 to 60 NM

NOWMLB
AMZ555-575-031045-
SHORT TERM FORECAST
NATIONAL WEATHER SERVICE MELBOURNE FL
243 AM EST SAT FEB 3 2007
COCOA BEACH TO JUPITER INLET OUT TO 20 NM-INDIAN RIVER-MARTIN-
OKEECHOBEE-OSCEOLA-SOUTHERN BREVARD-ST. LUCIE-
243 AM EST SAT FEB 3 2007
.NOW...
THROUGH 6 AM...LIGHT RAIN OR SPRINKLES WILL EXTEND FROM FAR SOUTHERN
SECTIONS OF BREVARD AND OSCEOLA COUNTIES SOUTH TO AROUND LAKE
OKEECHOBEE. THE AREA WILL CONTINUE TO WORK SOUTH DURING THE EARLY
MORNING HOURS.
$$
  
```

11.4.3 Tropical Weather Statement

Below is an example of a tropical weather statement.

```

TWDAT
TROPICAL WEATHER DISCUSSION
NWS TPC/NATIONAL HURRICANE CENTER MIAMI FL
105 AM EST SAT FEB 03 2007
TROPICAL WEATHER DISCUSSION FOR NORTH AMERICA...
CENTRAL AMERICA...THE GULF OF MEXICO...THE CARIBBEAN SEA...
NORTHEASTERN SECTIONS OF SOUTH AMERICA...AND THE ATLANTIC
OCEAN TO THE AFRICAN COAST FROM THE EQUATOR TO 32N.
THE FOLLOWING INFORMATION IS BASED ON SATELLITE IMAGERY...
METEOROLOGICAL ANALYSIS...WEATHER OBSERVATIONS...AND RADAR.
BASED ON 0000 UTC SURFACE ANALYSIS AND SATELLITE IMAGERY THROUGH
0515 UTC.
...THE ITCZ...
ITCZ AXIS IS CENTERED ALONG 8N13W 3N23W 1N30W CROSSING THE
EQUATOR NEAR 34W CONTINUING ALONG 2S40W INTO NE BRAZIL.
SCATTERED MODERATE CONVECTION IS WITHIN 150 NM S OF THE AXIS
BETWEEN 20W-24W. ISOLATED MODERATE IS WITHIN 180 NM N W OF 32W.
...DISCUSSION...
  
```

11.4.4 Marine WatchBox

The message "Weather Alarm, Press Menu Button." appears on the status bar when a tornado or thunderstorm warning is received. To see the information about the warning, press the **MENU** key to open the [Alert Box] in the [Weather] menu. The message is opened in the [Alert Box]. A sample warning message is shown below.

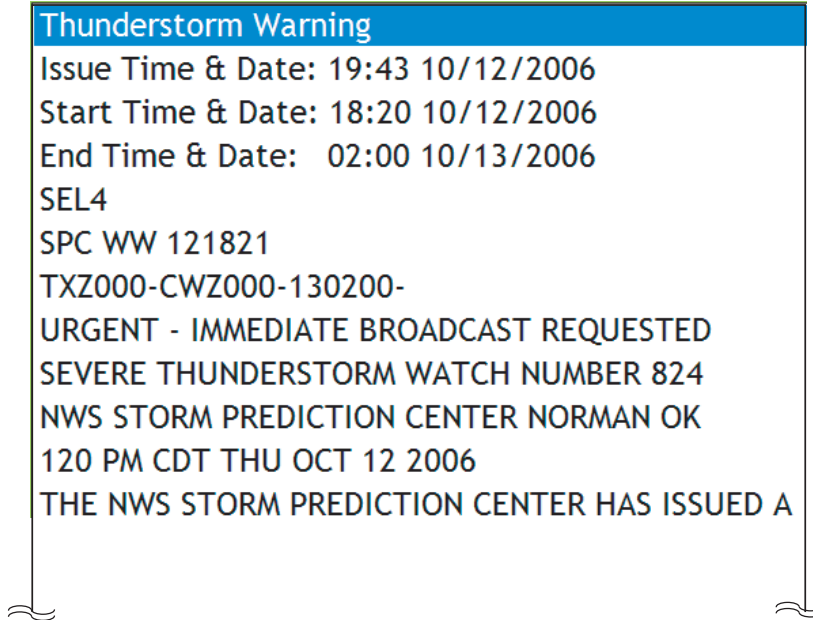

You can show or hide the [WatchBox] warning message with [Sirius Marine Watch-Box] in the [Alarm-General] menu.

11.5 Sirius Satellite Radio

The Sirius satellite radio provides round-the-clock, 100% commercial-free music from every genre plus sports, news, talk and comedy.

To show the Sirius satellite radio screen, long-push the **DATA/VOL** key, or select [Sat Radio] with the **RotoKey** then push the **RotoKey**.

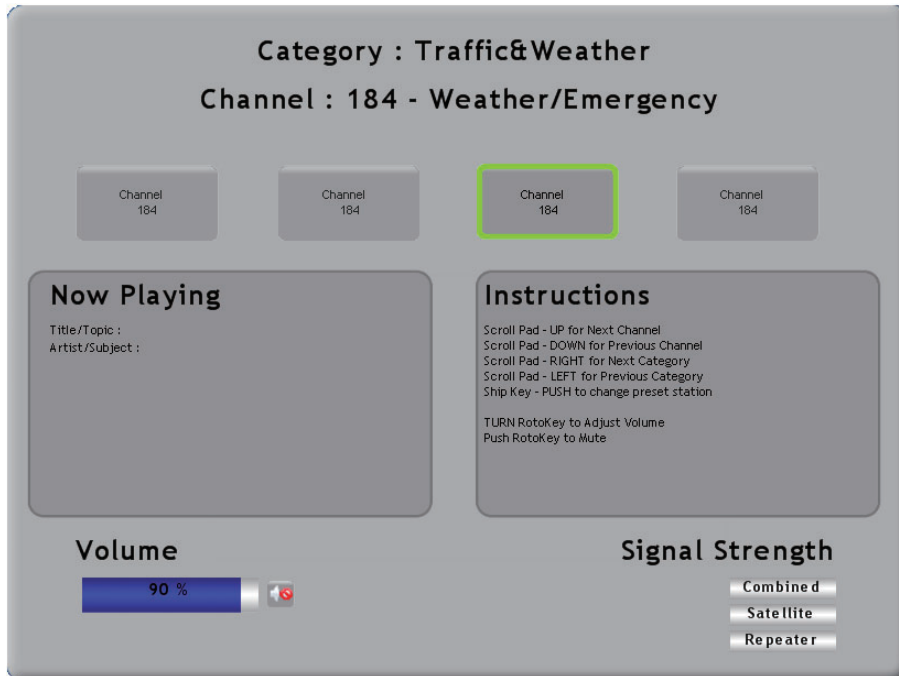

- Use the ScrollingPad to select a channel as shown below.
 - UP for next channel
 - DOWN for previous channel
 - RIGHT for next category
 - LEFT for previous category
 - **SHIP/3D** button to select station
- Rotate the **RotoKey** to adjust the volume.
- Push the **RotoKey** to turn off the audio.

11. SIRIUS WEATHER RECEIVER

This page is intentionally left blank.

12. AUTOMATIC IDENTIFICATION SYSTEM (AIS)

12.1 AIS Introduction





AIS is a system that continuously transmits the identification and position of your vessel to other nearby vessels. All such vessels also receive data from other AIS equipped vessels and display their positions and other relevant information. The AIS broadcasts this information over a VHF transceiver. Data include:

- Position
- Call sign
- Name of vessel
- Speed over ground
- Course over ground
- Name of position-fixing equipment
- Position of position-fixing equipment
- Rate of turn
- Heading

12.2 How to Show or Hide the AIS Display

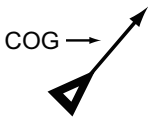
1. On the radar display or chart plotter display, push the **RotoKey** to show the soft controls. (In the default setting, long-push the key to show the soft controls.)
2. Use the **RotoKey** to select [Targets].
3. Use the **RotoKey** to select [AIS] then push the key to show or hide the AIS display.

12.3 AIS Target Symbols

Symbol	Target type	Color	Description
	AIS target	Light-blue or Green* ¹	COG is marked on the symbol with a solid line and arrow.
	Dangerous AIS target	Red	The CPA and TCPA of a target put the target on a collision course.
	Lost AIS target	Light-blue or Green* ¹	An AIS target becomes a lost target if a signal is not received from the AIS target for x* minutes. The lost target symbol is erased if a signal is not received for an additional x* minutes. * The time depends on the AIS transponder. Check the operator manual for your AIS transponder for information about lost targets.
	AIS-SART	Green or Red	This symbol appears when a message is received from an AIS-SART (Search and Rescue Transponder). When the target is a dangerous target, the symbol is red.

*¹ Light-blue, radar display; Green, chart plotter display

12.4 Proximity AIS Target Alarm

The proximity AIS target alarm tells you (with the audio and visual alarms) when an AIS target is within the distance you set here.

1. Press the **MENU** key to open the menu.
2. Open the [Alarm-Target] menu.

Radar Source

Echo Guard Alarm

CPA/TCPA Alarm

CPA Alarm Value

TCPA Alarm Value

Proximity AIS Target Alarm

Proximity AIS Target Alarm V...

3. Use the **RotoKey** to select [Proximity AIS Target Alarm] then push the key to activate (status icon is green) or deactivate the alarm.
4. Use the **RotoKey** to set the alarm value at [Proximity AIS Target Alarm Value].
5. Press the **MENU** key to close the menu.

12.5 How to Ignore AIS Targets

In the default setting, all AIS targets within 12 nm from your vessel are shown on the display. When the screen becomes full of AIS targets, you can remove some of the targets if you indicate a different display range.

Slow-moving targets within the AIS proximity alarm range cause frequent violation of the AIS proximity alarm. You can prevent this frequent violation if you ignore targets within the alarm range that are slower than the value you set.

1. Press the **MENU** key to open the menu.
2. Open the [Targets] menu.

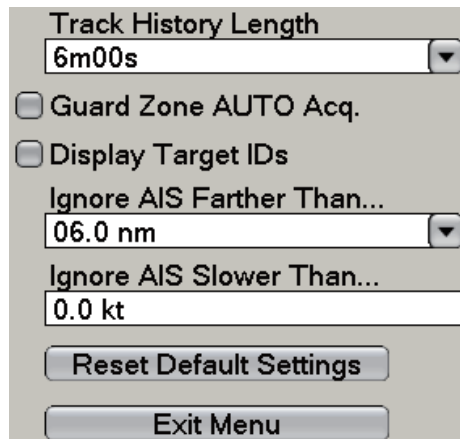

3. Use the **RotoKey** to select [Ignore AIS Targets Farther Than....]. This item removes the targets that are at a distance greater than the value you set here.

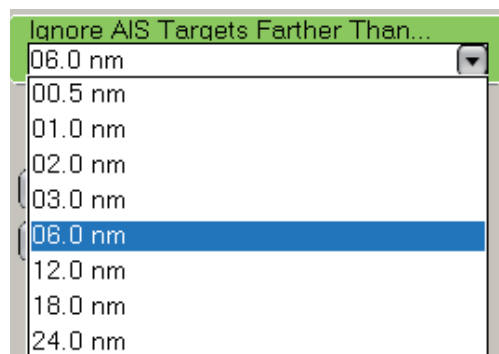

4. Use the **RotoKey** to select a range.
5. Select [Ignore AIS Targets Slower Than....]. This item prevents frequent violation of the AIS proximity alarm against AIS targets that are slower than the value set here.
6. Use the **RotoKey** to set a speed. The setting range is 0.0 - 9.9 (knots).
7. Press the **MENU** key to close the menu.

12.6 How to Display Target Data

The name, course, speed, range, bearing, etc. of an AIS target can be shown on the display. For simple data, put the cursor on an AIS target. For detailed data, put the cursor on the target then push the **left-click** button.

Name	PEGASUS
COG/SOG	56.2°T/6.8 kt
CPA/TCPA	3 m/55m03s
Range/Bearing	6.366 nm/26.7°T

AIS simple target data

Object Detail	
Name	VOYAGER
MMSI	MSN3456098
COG	56.2°T
SOG	6.8 kt
ROT	+0.7°/m
CPA	0.8593 nm
TCPA	23m08s
Range	6.366nm
Bearing	26.7°T
Destination	NISHINOMIYA
AIS Status	Normal
Call Sign	HQZE4509
Beam	8.0 m
Length	30.1 m
Position	34°37.1715'N; 135°10.2459

AIS detailed target data

12.7 Track History Display

The track of AIS targets can be shown on the display. A line starts from the rear of the target to show track history. You can select the track history plotting interval from the [Targets] menu. See paragraph 6.27.8 "Track History Display".

12.8 How to Show and Hide Target IDs

You can show or hide the target ID (MMSI) of AIS targets. Open the [Targets] menu and show or hide [Display Target IDs].

13. HOW TO ADJUST SETTINGS

After you understand the basic operating procedures of your equipment, you can set the equipment according to your needs.

- Set the equipment according to your system configuration.
- Change how the equipment operates and displays information.

All the adjustments are done from the menu. To restore the default settings for the selected sub menu, use the [Set Default] button that is provided on each sub menu.

Some of the items which you can adjust are as follows:

- RotoKey
- Data boxes
- Units of measurement
- System settings
- Hotpages
- Charts

13.1 RotoKey

The user can select how many soft controls to make available with the **RotoKey** in the chart plotter, radar, fish finder and camera modes. The three quantities are basic, standard and full. If those quantities do not meet your requirements, a “custom” set of keys is also available.

The table below shows the soft controls available for use in the chart plotter, radar, fish finder and camera modes.

Soft controls available in the chart plotter mode

Control label	Level 1	Function	Basic	Standard	Full
North-up		Select orientation mode.	Yes	Yes	Yes
Course Up			No	No	Yes
Head Up			Yes	Yes	Yes
Auto Shift	Auto Shift	Activate or deactivate auto shift.	No	No	Yes
3D	3D displays	Select 3D/2D display.	No	Yes	Yes
2D View		2D view.	No	Yes	Yes
Aerial View		3D aerial view.	No	Yes	Yes
Underwater		3D underwater view.	No	No	Yes
3D Pan/Tilt		3D display orientation tool.	No	No	Yes
Highway		3D highway display	No	Yes	Yes
Chart	Chart	Select chart type.	Yes	Yes	Yes
Raster		Show raster chart.	Yes	Yes	Yes
Vector		Show vector chart.	Yes	Yes	Yes
Overlay	Overlay	Select overlay display.	Yes	Yes	Yes
Radar		Show or hide radar overlay.	No	Yes	Yes
Sat Photo		Show or hide sat photo overlay.	No	Yes	Yes
Dpth Shade		Show or hide depth shading.	No	Yes	Yes
Tide Icons		Show or hide tide icons.	No	Yes	Yes
Currents		Show or hide tidal currents.	No	Yes	Yes
Weather	Weather	Select weather display.	Yes	Yes	Yes
Wx Radar		Show or hide weather radar.	Yes	Yes	Yes
Wx Data		Show or hide weather data.	Yes	Yes	Yes
Adv Wx Data		Show or hide adv. weather data.	Yes	Yes	Yes
Marine Zone		Show or hide marine zone.	Yes	Yes	Yes
Tx	Radar	Control radar stand-by and TX.	Yes	Yes	Yes
Track		Show or hide track of your vessel.	Yes	Yes	Yes
Targets		Control ARPA and AIS targets.	No	No	Yes
ARPA		Show or hide ARPA display.	No	No	Yes
AIS		Show or hide AIS display.	No	No	Yes
History		Show or hide history display.	No	No	Yes
Cancel All		Cancel tracking on all targets.	No	Yes	Yes
Clear Lost		Clear ARPA lost target.	No	Yes	Yes
DSC		Turn DSC message info on/off.	No	No	Yes
Points	Control points		No	Yes	Yes
Alpha List		Show Alpha List.	No	Yes	Yes
Local List		Show Local List.	No	Yes	Yes
Show		Show or hide points.	No	No	Yes

Control label	Level 1	Function	Basic	Standard	Full
Routes	Control routes		No	Yes	Yes
New		Create a new route.	No	Yes	Yes
List		Show Routes list.	No	No	Yes
Reset Nav		Restart XTE.	Yes	Yes	Yes
Skip WPT		Skip waypoint on a route	No	Yes	Yes
Cancel Nav		Stop following a route.	Yes	Yes	Yes
Reverse		Reverse route following direction.	No	Yes	Yes
Show		Show or hide routes now displayed.	No	No	Yes
Animate	Animate	Animate weather or tidal current forecast.	No	No	Yes
Countdown		Start or stop countdown timer.	No	Yes	Yes
Ruler	Ruler tool	Measure range and bearing between two points.	No	Yes	Yes
Tide Graph		Show tide graph.	Yes	Yes	Yes
Sleep		Sleep the NavNet 3D equipment.	No	Yes	Yes

Soft controls available in the radar mode

Control label	Level 1	Basic	Standard	Full
North-Up	North-up, Course-up, Head-up.	No	Yes	Yes
North Up		No	Yes	Yes
Course Up		No	Yes	Yes
Head Up		No	Yes	Yes
True motion	Activate or deactivate true motion display.	No	No	Yes
Auto Shift	Activate or deactivate auto shift.	No	No	Yes
Tx	Switch between transmit and stand-by.	Yes	Yes	Yes
Auto Sea	Select auto sea adjustment method.	No	Yes	Yes
Advanced	Auto sea for open waters.	No	Yes	Yes
Coastal	Auto sea for coastal waters.	No	Yes	Yes
Filters	Activate or deactivate interference rejector, echo stretch, and echo average.	No	No	Yes
Int Rej	Activate or deactivate interference rejector.	No	No	Yes
Stretch	Activate or deactivate echo stretch.	No	No	Yes
Average	Activate or deactivate echo average.	No	No	Yes
Rings	Show or hide range rings.	Yes	Yes	Yes
Hdg Ln Off	Show or hide heading line.	No	Yes	Yes
Echo Trail	Activate or deactivate echo trails.	No	No	Yes
Clr Trail	Clear echo trails.	No	No	Yes
EBL	Control EBLs.	No	Yes	Yes
EBL 1	Activate EBL1.	No	Yes	Yes
EBL 2	Activate EBL2.	No	No	Yes
Clear 1	Deactivate EBL1.	No	Yes	Yes
Clear 2	Deactivate EBL2.	No	No	Yes
VRM	Control VRMs.	No	Yes	Yes
VRM 1	Activate VRM1.	No	Yes	Yes
VRM 2	Activate VRM2.	No	No	Yes
Clear 1	Deactivate VRM1.	No	Yes	Yes
Clear 2	Deactivate VRM2.	No	No	Yes

13. HOW TO ADJUST SETTINGS

Control label	Level 1	Basic	Standard	Full
Guard Zone	Control guard zones.	No	No	Yes
Zone 1	Activate guard zone 1.	No	No	Yes
Zone 2	Activate guard zone 2.	No	No	Yes
Clear 1	Deactivate guard zone 1.	No	No	Yes
Clear 2	Deactivate guard zone 2.	No	No	Yes
Targets	Control ARPA and AIS targets.	No	Yes	Yes
ARPA	Show or hide ARPA display.	No	No	Yes
AIS	Show or hide AIS display.	No	No	Yes
History	Show or hide history display.	No	No	Yes
Cancel All	Stop tracking on all ARPA targets.	No	Yes	Yes
Clear Lost	Clear lost ARPA target.	No	Yes	Yes
DSC	Turn DSC message info on/off.	No	Nos	Yes
Active Route	Show or hide active route.	No	No	Yes
Sleep	Sleep the NavNet 3D equipment.	No	Yes	Yes

Soft controls available in the fish finder mode

Control label	Level1	Basic	Standard	Full
HF	Select mode.	Yes	Yes	Yes
HF		Yes	Yes	Yes
LF		Yes	Yes	Yes
Dual		Yes	Yes	Yes
Auto	Activate or deactivate automatic operation.	Yes	Yes	Yes
Fishing	Activate fishing automatic mode.	Yes	Yes	Yes
Cruising	Activate cruising automatic mode.	Yes	Yes	Yes
Off	Activate manual mode.	Yes	Yes	Yes
Zoom	Zoom display selection.	No	Yes	Yes
Btm Lock	Select bottom lock display.	No	Yes	Yes
Btm Zoom	Select bottom zoom display.	No	Yes	Yes
Mkr Zoom	Select marker zoom display.	No	Yes	Yes
Off	Deactivate zoom display.	No	Yes	Yes
Btm disc	Show or hide bottom discrimination display.	No	Yes	Yes
A-Scope	Show or hide A-scope display.	No	Yes	Yes
Auto Range*	Activate or deactivate auto range.	Yes	Yes	Yes
Split Range*	Activate or deactivate individual adjustment of range on high and low frequencies.	Yes	Yes	Yes
Temp	Show or hide temperature graph display.	No	Yes	Yes
Fish Alarm	Activate or deactivate fish alarm.	No	No	Yes
Sleep	Sleep the NavNet 3D equipment.	No	Yes	Yes

* BBDS1, DFF series, FCV-1150 only

Soft controls available in the instrument mode

Control label	Level1	Basic	Standard	Full
Steering	Show steering display.	Yes	Yes	Yes
Engine	Show engine display.	Yes	Yes	Yes
Wind & Wx	Show wind and weather display.	Yes	Yes	Yes
True Wind	Show true wind display.	No	Yes	Yes
App Wind	Show apparent wind display.	No	Yes	Yes
Sleep	Sleep the NavNet 3D equipment.	No	Yes	Yes

Soft controls available in the camera mode

Control label	Level1	Basic	Standard	Full
Vid Source	Select video source.	Yes	Yes	Yes
Input1	Input 1	Yes	Yes	Yes
Input2	Input 2	Yes	Yes	Yes
IP1	IP camera 1	Yes	Yes	Yes
IP2	IP camera 2	Yes	Yes	Yes
IP3	IP camera 3	Yes	Yes	Yes
IP4	IP camera 4	Yes	Yes	Yes
Vid Cycle	Select video switching cycle.	Yes	Yes	Yes
Cycle 1	Select video switching cycle 1.	Yes	Yes	Yes
Cycle 2	Select video switching cycle 2.	Yes	Yes	Yes
Video ID	Show or hide video ID.	Yes	Yes	Yes
Brightness	Adjust brightness of video image.	No	No	Yes
Colors	Select number of colors to show.	No	No	Yes
Contrast	Adjust contrast of video image.	No	No	Yes
Sleep	Sleep the NavNet 3D equipment.	No	Yes	Yes

13.1.1 How to Select the RotoKey Set to Use

You have four RotoKey sets that you can select: [Basic], [Standard], [Full], and [Custom]. Select the set to use as follows:

1. Press the **MENU** key to open the menu.
2. Open the [My NavNet-General] menu.
3. Use the **RotoKey** to display the [RotoKey] options window.



4. Use the **RotoKey** to select [Basic], [Standard], [Full] or [Custom]. (For [Custom], see the next section for how to set the **RotoKey**.)
5. Press the **MENU** key to close the menu.

13.1.2 How to Set the RotoKey

If the Basic, Standard or Full sets of soft controls are not acceptable, you can select the soft controls to use on the [My NavNet] menu. To use your selections, set RotoKey in the [My NavNet-General] menu to [Custom].

1. Press the **MENU** key to open the menu.
2. Open the [My NavNet-Chart], [My NavNet-Radar], [My NavNet-Fish Finder] or [My NavNet-Instruments] sub menu as appropriate. For example, open the [Radar] sub menu.



3. Use the **RotoKey** to select a soft control. Push the key to activate or deactivate the soft control.
4. Press the **MENU** key to close the menu.

13.2 Data Boxes

The section 1.14 shows how to select the data to show in the data boxes. This section shows you set the boxes from the [DataBox] menu.

13.2.1 How to Set the Data Boxes

1. Press the **MENU** key to open the menu.
2. Open the [DataBox] menu.

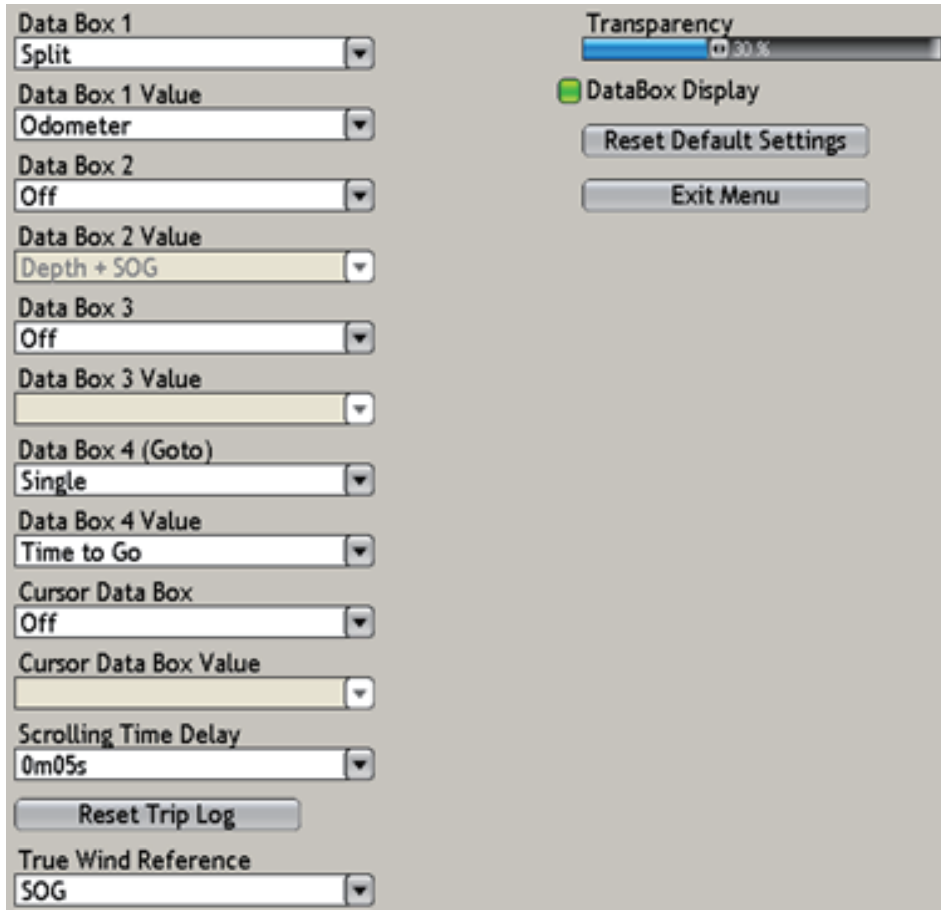

3. Use the **RotoKey** to select [Data Box] 1-4 or [Cursor Data Box] then push the **RotoKey**. For example, select [Data Box 1].

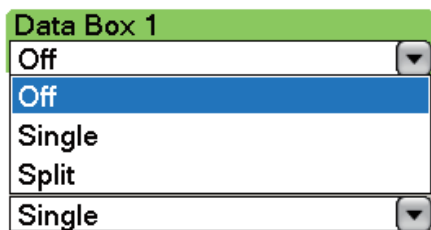

Data box options

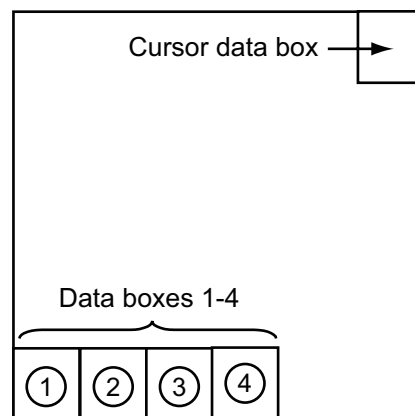

Data box locations

13. HOW TO ADJUST SETTINGS

4. Select how to show the data in the data box.
Off: Turn off the data.
Single: Display data individually.
Split: Display two items per box. For example, SOG and COG show both of those data in one box. ("Pos" is a special example, because it is a two-line display.)
5. Use the **RotoKey** to select the [Data Box Value] combo box related to the data box number selected at step 3.

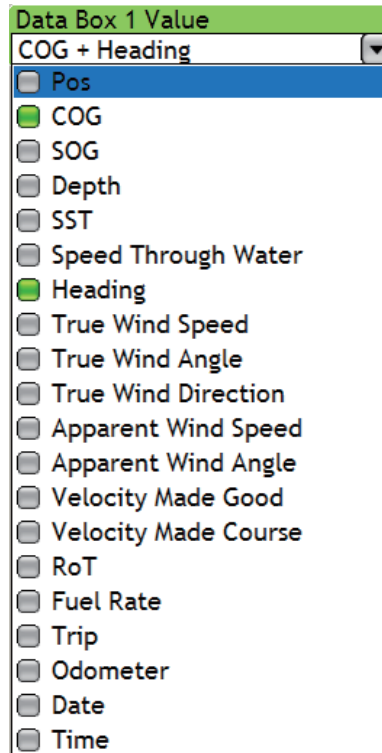

6. Use the **RotoKey** to select or remove the data.
7. Set the #2, #3 and #4 data boxes and the cursor data box by the same method.
8. If you have some boxes that are set for a split display, select the amount of time to show each data. Select [Scrolling Time Delay] then push the **RotoKey**.

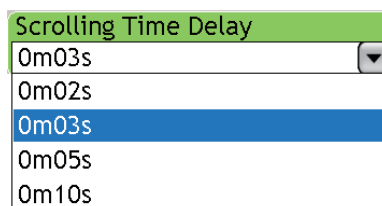

9. Use the **RotoKey** to select the amount of time to display each data pair.
10. If you have a wind sensor, you can select to display wind value in speed over ground (SOG) or speed through water (STW) when changing to Apparent Wind indication from True Wind. Use the **RotoKey** to select [True Wind Reference].



11. Use the **RotoKey** to select SOG or STW. (In case of wind data fed from the FU-RUNO FI-50 series, STW is used when there is no heading data, regardless of this setting.)
12. Press the **MENU** key to close the menu.

13.2.2 How to Show or Hide all Data Boxes

You can show or hide all data boxes. Select [DataBox Display] at the bottom of the [DataBox-General] menu then push the **RotoKey** to show or hide all data boxes. You can also hide or show the data boxes with the **DATA/VOL** key.

13.2.3 How to Adjust Transparency of Data Boxes

You can adjust the degree of transparency for the data boxes with the [Transparency] slider. The available degree of transparency is 0-80(%). (Alpha blending technology is used for transparency effects.)

13.3 How to Set the Display Selection Window

The section 1.5 shows how to select a display at the display selection window. The default display selection window provides five displays, identified as "hotpages," in configurations according to the equipment that you have in your network. If the arrangement of the hotpages does not meet your requirements, you can change the hotpages as necessary. You can select the number of hotpages to show from five to ten and split a hotpage up to four ways. For example, you can show the radar and fish finder displays in a two-way split screen.

You can select how to split a hotpage by four different methods: full-screen, two-way, three-way and four-way. The displays available depend on the screen division selected and your system configuration. The table below describes screen division and possible display.

Screen division	Possible display
Full	Chart plotter, radar, camera, fish finder, weather facsimile
Two-way split	Chart plotter, radar, fish finder
Three-way split	Chart plotter, radar, fish finder
Four-way split	Chart plotter, radar, camera, fish finder, instrument

13.3.1 How to Set the Number of Hotpages to Show

Set the number of hotpages to show on the display selection window as follows:

1. Press the **MENU** key to open the menu.
2. Open the [My NavNet-General] menu.
3. Use the **RotoKey** to select [Hotpage Number].
4. Use the **RotoKey** to select a number.
5. Press the **MENU** key to close the menu.

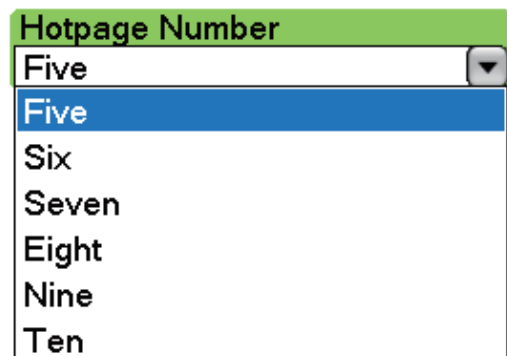

13.3.2 How to Set a Hotpage

This section shows how to set a hotpage. The procedure shown below describes how to put the radar, chart plotter and fish finder displays in a three-way split screen.

1. Press the **DISP** key to show the display selection screen.
2. Long-push the **RotoKey** to show the hotpage arrangement screen, shown below.

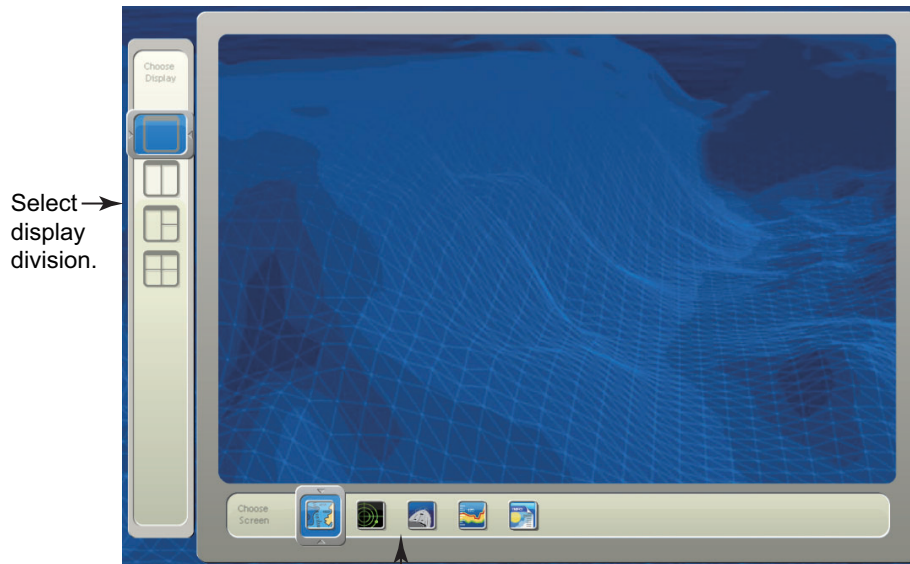

3. Rotate the **RotoKey** to select the three-way split icon at the left-side of the screen then push the **RotoKey**. The chart plotter display appears on left-half of the screen.



4. Rotate the **RotoKey** to select one of the display icons (for example, the radar display) at the bottom of the screen. Push the **RotoKey**.
5. The yellow rectangle moves to the top-right 1/4 of the screen. Rotate the **RotoKey** to select a display (for example, the chart plotter display) then push the **RotoKey**.
Note: To return one step, use the **CANCEL** key.

- The yellow rectangle moves to the bottom-right 1/4 screen. Rotate the **RotoKey** to select a display (for example, the fish finder display) then push the key. Your arrangement of displays appears on the screen and the display selection window is updated according to your arrangement.

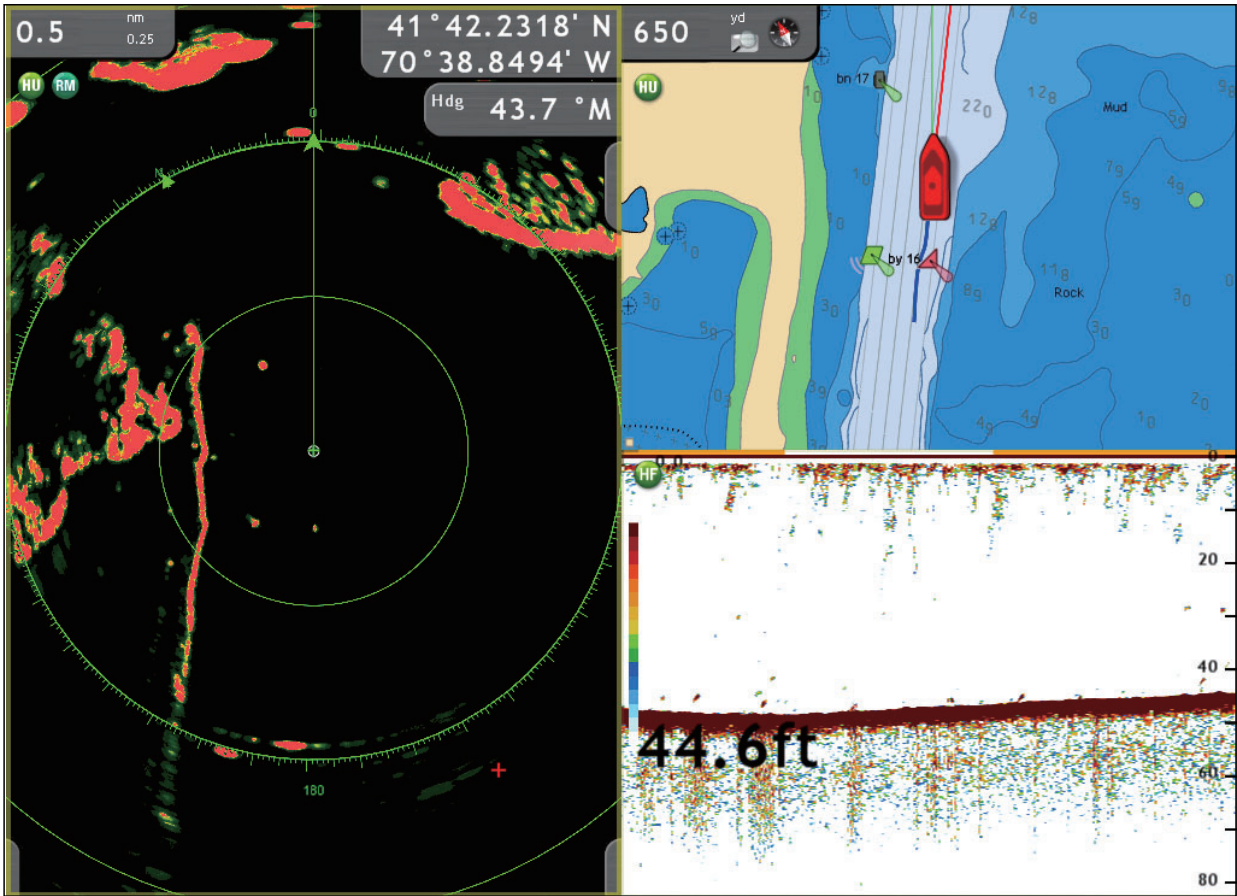

13.4 Global Menu

The [Global] menu has two sub menus for general setting of the equipment. The [Global-General] menu includes font size, brilliance settings, position format, etc. The [Global-Units] menu sets units of measurement for range, depth, height, speed, etc.

13.4.1 Global-General Menu

The [Global-General] menu is where you can turn off the key beep, and select position format, time display format, font size, etc. See the next page for full description.

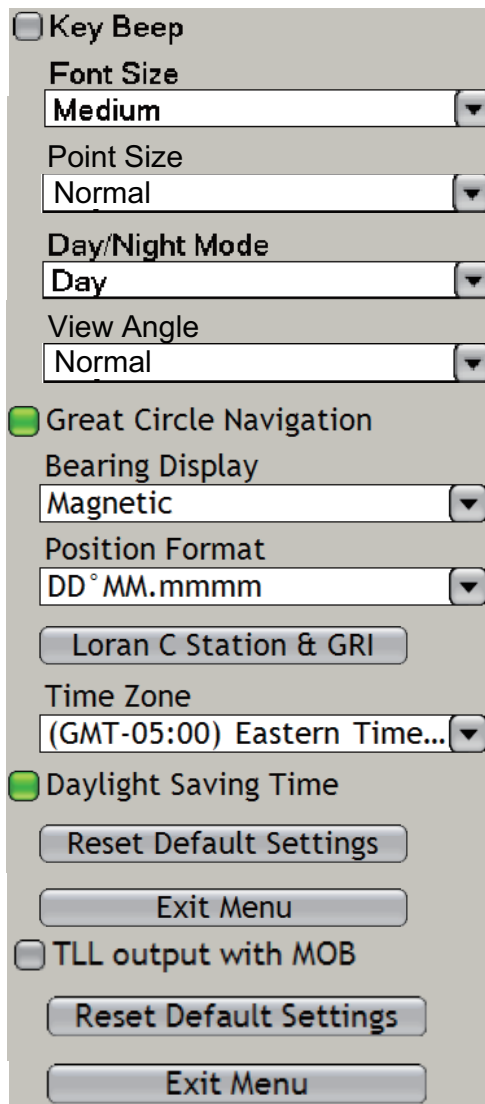

Global-General menu description

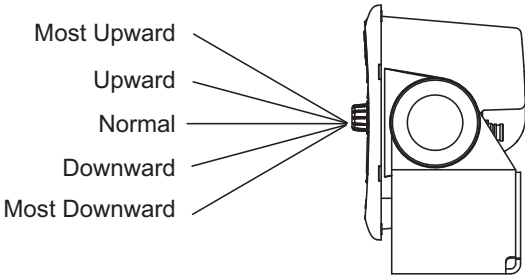
Menu item	Function	Options
Key Beep	Activate or deactivate the key beep which sounds when a key (incl. RotoKey) is operated.	ON, OFF
Font Size	Select the font for all indications, menus and the like. After you change the font size, the system is reset to use the new font.	Medium, Large
Point Size	Change the size of all icons.	Normal, Small, Big
Day/Night Mode	Automatically set the color arrangement and brilliance according to time of day.	Day, Dusk, Night
View Angle	Change the angle of view on all displays and menus. Select an "upward" setting to change the angle of view to upward, or select a "downward" setting to view from downward direction. 	Most Upward, Upward, Normal, Downward, Most Downward
Great Circle Navigation	The two methods to measure the course distances are great circle and Rhumb line. Great circle is the shortest line that joins two points on the surface of the earth. Rhumb line is a straight line compass course between two points. The great circle path is short, but requires frequent heading changes.	ON, OFF
Bearing Display	The mode (magnetic or true) of all heading and bearing data.	True, Magnetic
Position Format	Select how to display position data, in latitude and longitude, Loran C TDs, or MGRS (Military Grid Reference System).	DDD.dddddddDD°M.mmmm, Loran C, MGRS
Loran C Station & GRI	Select the Loran C stations and GRIs to use to get Loran C position.	
Time Zone	Set your time zone.	GMT times zones for the world
Daylight Saving Time	Set for ON when your area uses daylight saving time.	ON, OFF
TLL Output with MOB	Set for ON to output position at the time of MOB. Requires position and waypoint position data.	ON, OFF

13.4.2 Global-Units Menu

The [Global-Units] menu lets you select units of measurement for range, length, depth, height, sea surface temperature, speed, wind speed, air pressure, oil /boost pressure, and volume.

The screenshot shows the Global-Units menu with the following settings:

- Range (Long): Nautical Mile
- Range (Short): Yard
- Short/Long Change Over: 0.5 nm
- Depth: Foot
- Height: Foot
- Temperature: Fahrenheit Degree
- Speed: Knot
- Wind Speed: Knot
- Air Pressure: HectoPascal
- Oil / Boost Pressure: KiloPascal
- Volume: Gallon

Description of Global-Units menu

Menu item	Options
Range (Long)	Nautical mile, kilometer, mile
Range (Short)	Foot, meter, yard
Short/Long Change Over	Set the distance at which to change between short and long range. Set the long range here.
Depth	Foot meter, fathom, Passi and Braza
Height	Foot, meter
Temperature	Celsius degree, Fahrenheit degree
Speed	Knot, kilometer per hour, mile per hour, meter per second
Wind Speed	Knot, kilometer per hour, mile per hour, meter per second
Air Pressure	Hectopascal, millibar, millimeter of mercury, inch of mercury
Oil / Boost Pressure	Kilopascal, bar, pound per square inch
Volume	Gallon, liter

13.5 System Menu

The [System] menu has menus for general system settings, sensor calibration, radar, fish finder.

13.5.1 System-General Menu

The [System-General] menu selects the language to use, sets the message window dwell time, shows the connection diagram, etc.

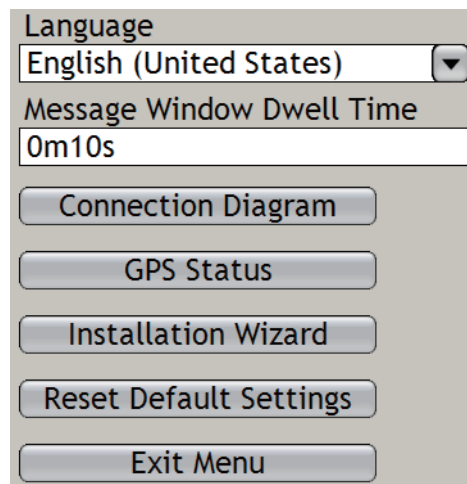

Language: Select the language to use. See section 1.16

Message Window Dwell Time: Set the number of seconds to leave a message window open before the window is closed.

Connection Diagram: Display the parts of your network. For use by service technicians.

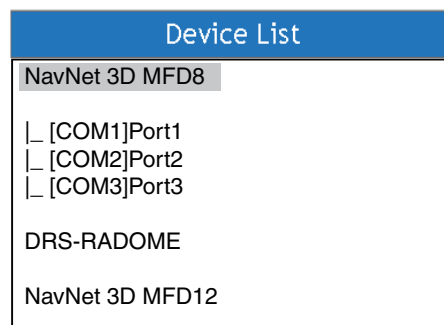

GPS Status: Show the status of GPS satellites. See section 14.5 "GPS Status Display".

Installation Wizard: Start the Installation Wizard to install the system. See the Installation Manual.

Reset Default Settings: Restore all default settings for your system.

13.5.2 System-Calibration Menu

The [System-Calibration] menu lets you enter the offsets for external sensors (speed, wind, temperature) to show true values on the display.

The screenshot displays the System-Calibration Menu with the following settings:

- Draft:** +00.0 ft
- Speed Through Water:** 0 %
- Sea Surface Temperature (SS...):** +00.1 °F
- Wind Damping Time:** 05s
- Wind Speed Calibration:** 0 %
- Wind Direction Offset:** +000 °
- Water Type:** Salt

At the bottom of the menu are two buttons: "Reset Default Settings" and "Exit Menu".

Draft: In the default setting, the fish finder shows the depth from the transducer. For depth from the surface, set the draft of your vessel here.

Speed Through Water: If the speed indication is wrong, add an offset to the speed output by the speed sensor to get the correct speed indication. For example, if the speed indication is 10 kt and the true speed is 11 kt, enter +10%.

Sea Surface Temperature: If the temperature indication is wrong, add an offset to the temperature output by the temperature sensor to get the correct temperature indication. For example, if the temperature indication is 60 degrees and the true temperature is 54 degrees, enter -6.

Wind Damping Time: Set wind damping time. The setting range is 0-99 (seconds).

Wind Speed Calibration: If the wind speed indication is wrong, add an offset to the wind speed output by the wind sensor to get the correct wind speed indication.

Wind Direction Offset: If the wind direction indication is wrong, add an offset to the wind direction output by the wind sensor to get the correct wind direction indication.

Water Type: Select the type of water your vessel is used in, saltwater or freshwater.

13.5.3 System-Radar Menu

The [System-Radar] menu provides the radar functions like manual tuning, tx sector area (area of no transmission) and pulse length.

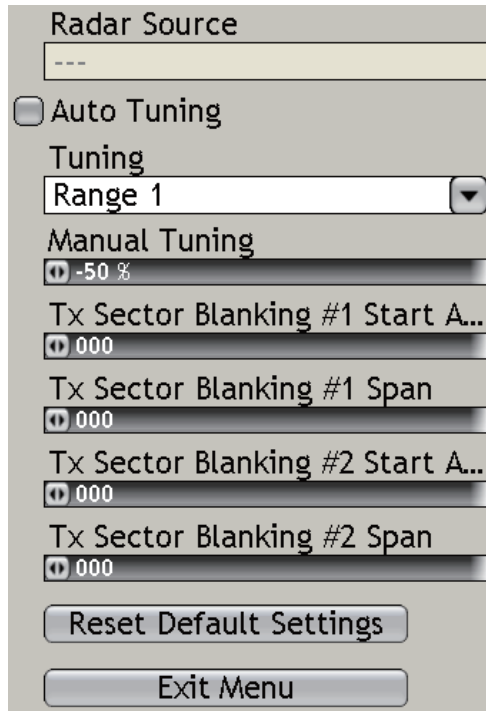

Manual Tuning: If you require manual tuning, do the following:

1. Use the **RANGE** key to select the 24-mile range.
2. Press the **MENU** key to open the menu.
3. Open the [System-Radar] menu.
4. Turn off Auto Tuning.
5. At the menu item [Tuning], select Range 1 (range 1 in the dual-range mode) or Range 2 (range 2 in dual-range mode) then push the **RotoKey**.
6. Use the **RotoKey** to select Manual Tuning then push the **RotoKey**.
7. Rotate the **RotoKey** to adjust the tuning. The range is -50 to +50(%).
8. Push the **RotoKey** to validate your setting.
9. Press the **MENU** key to close the menu.

Tx Sector Blanking #1(#2) Start Angle: Stop the transmission within the sector you indicate. For example, mark a blind sector on the display for the area where transmission is prevented by a mast. This sector is normally set by the installer of the equipment.

You can set two sectors. One sector must be less than 135 degrees in width. The total width of two sectors must not be more than 270 degrees.

Tx Sector Blanking #1(#2) Span: Set the width of the blind sector (in degrees) here.

13.5.4 System-DFF1/BBDS1/DFF1-UHD, -DFF3/FCV Menu

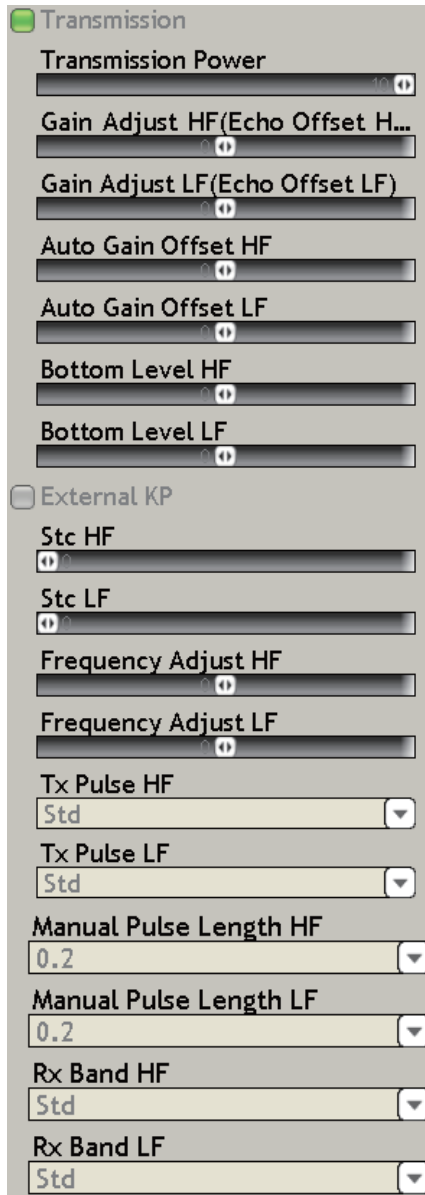

Transmission: Turn the transmission on or off. Leave on normally.

Transmission Power: Interference can appear on the screen when the fish finder on your vessel and another vessel have the same TX frequency. To prevent this interference, lower your TX power and ask the other vessel to lower their TX power. The TX power is available in Off, Min, 1-10, and 10 provides the highest TX power.

Gain Adjust HF (LF): If the gain setting is wrong, or there is a difference in the gain between the low and high frequencies, you can balance the gain for the two frequencies here.

Auto Gain Offset HF (LF): If the auto gain offset is wrong, or there is a difference in the gain between the low and high frequencies, set an offset here to balance auto gain for the two frequencies.

Bottom Level HF (LF): The default bottom level setting (0) takes that two strong echoes received in sequence are bottom echoes. If the depth indication is not stable in the default setting, adjust the bottom level here. If vertical lines appear from the bot-

tom echo in the bottom lock display, lower the bottom level to erase the vertical lines. If you can not identify the fish near the bottom from the bottom echo, increase the bottom level. **For the DFF1/BBDS1/DFF1-UHD**, set both of these items to “-20”.

External KP: Turn on to sync with external keying pulse.

Stc HF (LF): Delete unnecessary echoes (plankton, air bubbles, etc.) near the surface that hide the fish near the surface. The setting range is 0-10, and 0 is Off. “10” deletes unnecessary echoes from the surface to approximately 16 ft. Make sure you do not use more STC than necessary, because you can erase the small echoes near the surface.

Frequency Adjust HF (LF): You can adjust the TX frequency of both the low- and high-frequency transducers. Use this feature when your fish finder and another fish finder operate on the same frequency, causing interference. Change the frequency of your transducer by enough percentage points to remove the interference.

TX Pulse HF (LF): The pulse length is automatically set according to range and shift, however it can also be adjusted manually. Use a short pulse for better resolution and a long pulse when detection range is important. To improve resolution on zoom displays, use “Short 1” or “Short 2”. Short 1 improves the detection resolution, but the detection range is shorter than with “Std” (pulse length is 1/4 of Std). Short 2 raises the detection resolution, however detection range is shorter (pulse length is about 1/2 of Std) than Std. Std is the standard pulse length, and is suitable for general use. “Long” Increases the detection range but lowers the resolution (about 1/2 compared to the Std pulse length). “Manual” enables manual setting of pulse length.

Manual Pulse Length HF (LF): This item is effective when TX Pulse is set for Manual. The pulse length may be set between 0.05 msec and 5.0 msec. A short pulse length gives better resolution, but decreases the detection range. A long pulse increases the detection range, but lowers the resolution.

Rx Band HF (LF): The Rx bandwidth is automatically set according to pulse length. To decrease noise, select “Narrow”. For better resolution, select “Wide”.

13.5.5 System-ETR-6/10N Menu

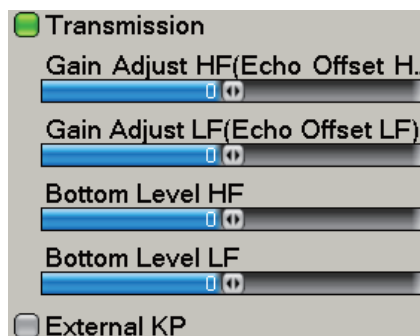

External KP: Turn on to sync with external keying pulse.

For [Transmission], [Gain Adjust] and [Bottom Level], see the descriptions in paragraph 13.5.4.

13.5.6 System-ETR-30N Menu

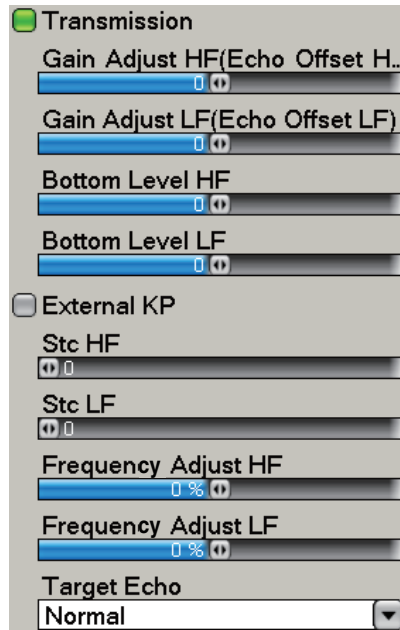

Stc HF (LF): Delete unnecessary echoes (plankton, air bubbles, etc.) near the surface. Use this feature to clear the surface of unnecessary echoes to look for surface fish. The setting range is 0-10, and 0 is Off. "10" deletes unnecessary echoes from the surface to approximately 16 ft. If the echoes near the surface are erased completely, decrease the Stc.

Frequency Adjust HF (LF): You can adjust the TX frequency of both the low- and high-frequency transducers. Use this feature when your fish finder and another fish finder operate on the same frequency, causing interference. Change the frequency of your transducer by enough percentage points to remove the interference.

Target Echo Set your fishing purpose, [Normal] or [Surface]. Select [Surface] when your purpose is to find the fish near the surface.

For [Transmission], [Gain Adjust], [Bottom Level], see paragraph 13.5.4 "System-DFF1/BBDS1/DFF1-UHD, -DFF3/FCV Menu". For External KP, paragraph 13.5.5 "System-ETR-6/10N Menu".

13.6 My NavNet-General Menu

This section provides the information for the items in the [My NavNet] menu that are not described in other chapters.

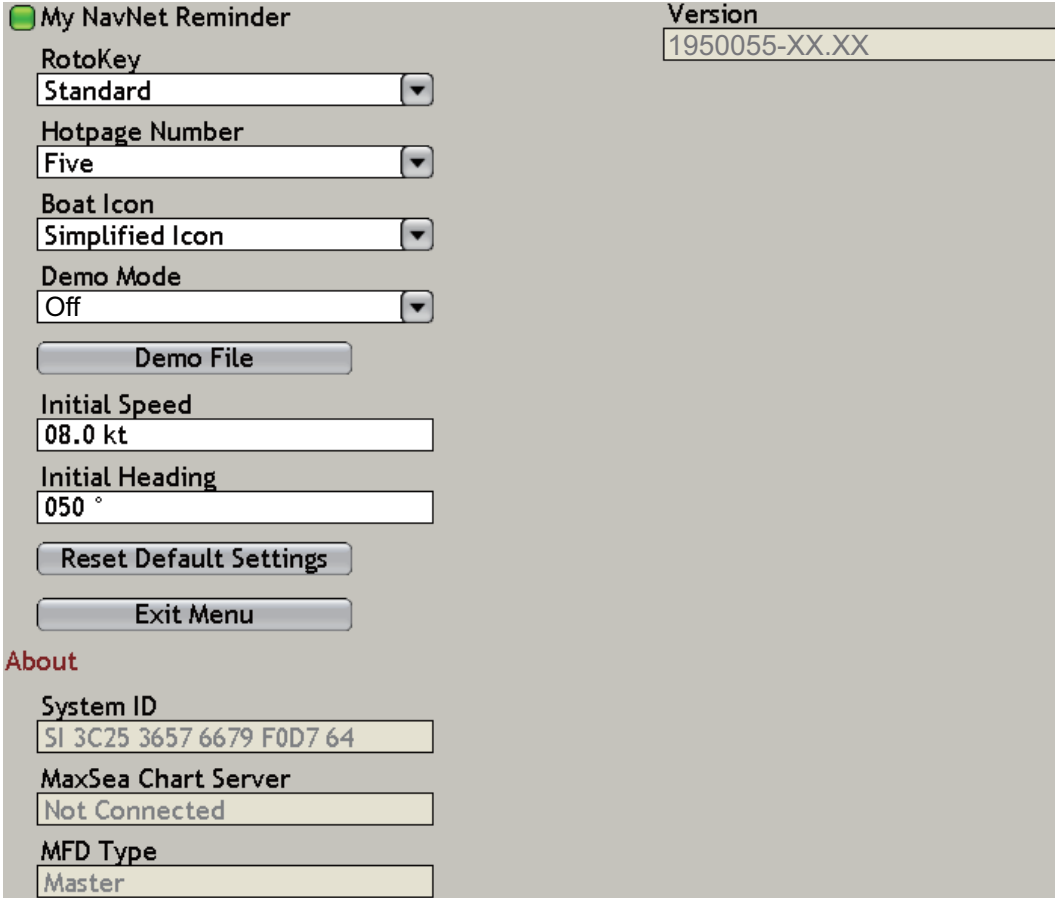

My NavNet Reminder Version
1950055-XX.XX

RotoKey
Standard

Hotpage Number
Five

Boat Icon
Simplified Icon

Demo Mode
Off

Demo File

Initial Speed
08.0 kt

Initial Heading
050 °

Reset Default Settings

Exit Menu

About

System ID
SI 3C25 3657 6679 F0D7 64

MaxSea Chart Server
Not Connected

MFD Type
Master

My NavNet Reminder

The [My NavNet Reminder] tells you to check your [My NavNet] settings every 10 times you turn on the power. You can activate or deactivate this message.

Demo Mode

The demo mode helps you understand the features of your system. The demo mode does not require the connection of a radar, fish finder or position-fixing equipment. Most functions are available so that you can learn all about your system when you like. You can save your routes, points, etc. to the memory for future use.

To activate the demo mode:

1. Use the **RotoKey** to select [Demo Mode] then push the key to open the options window.
2. Use the **RotoKey** to select [Internal] then push the **RotoKey** to confirm selection.
3. Use the **RotoKey** to select [Demo File] then push the key. The demo file provided with the equipment has the initial position as Cape Cod, Massachusetts, USA.
4. Push the **RotoKey**.
5. Set [Initial Speed] and [Initial Heading].
6. Press the **MENU** key to close the menu.

13. HOW TO ADJUST SETTINGS

To control the demo mode from the chart plotter display:

1. Right-click the chart plotter display to show the pop-up menu.

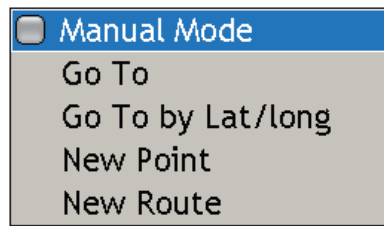

2. Use the **RotoKey** to select [Manual Mode] then push the key to activate or deactivate the demo mode.

System ID and Version

Show the ID and version number of your system.

13.7 How to Control Charts

This section shows you how to control your chart catalog, from the [Chart-Data Catalog] menu. From this menu you can see, update, add and delete charts.

13.7.1 How to View Your Charts

1. Press the **MENU** key to open the menu.
2. Open the [Chart-Data Catalog] menu.

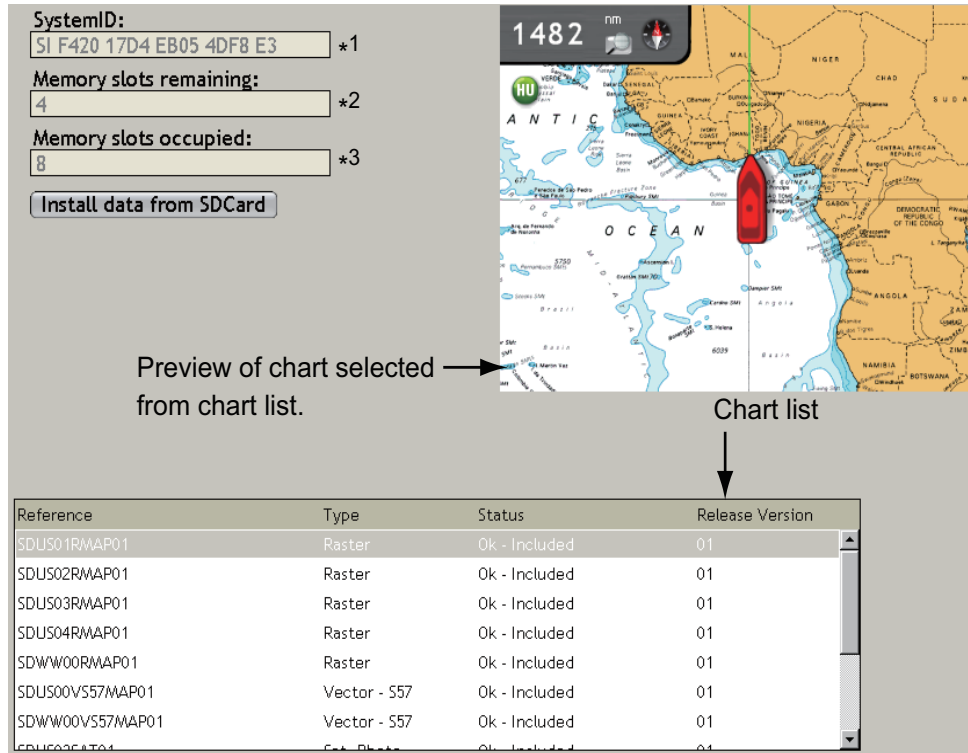

- *1 Navnet ID
 - *2, 3 One (chart) memory slot=2 GB. A total of 24 GB in the hard drive is allotted for charts.
3. Rotate the **RotoKey** until a blue rectangle is about the chart list as shown below.

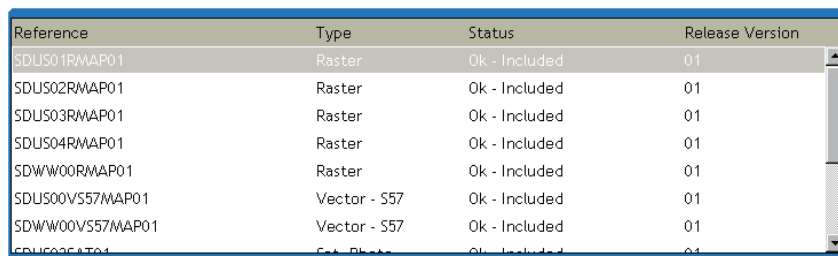

4. Push the **RotoKey**.
5. Rotate the **RotoKey** to select a chart. A preview of the chart appears at the upper 1/4 of the screen.
6. Press the **MENU** key to close the menu.

13.7.2 How to Update Charts

There are two types of chart of charts, free and for fee. The for fee charts require an unlock code to use them.

You can obtain free and for fee charts from the NavNet web site www.navnet.com. Contact your dealer for how to obtain the unlock code.

1. Put the SD card that contains the chart data into one of the slots in the card drive.
Note: An SDHC card of up to 32 GB capacity can be used.
2. Press the **MENU** key to open the menu.
3. Open the [Chart-Data Catalog] menu.
4. Rotate the **RotoKey** to select the [Install data from SD card] button then push the **RotoKey**. The message shown below appears.

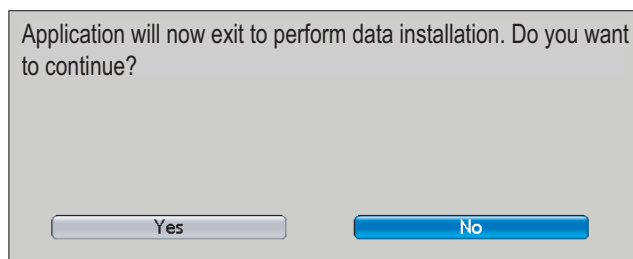

5. Rotate the **RotoKey** to select Yes then push the key. The application quits and chart loading starts. A progress bar shows loading progress.

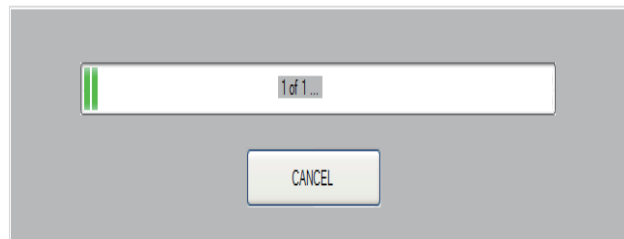

Note: Do not remove an SD card or turn off the power while a chart is being loaded. Loading can take a long time depending on the amount of data to be loaded. When loading is completed, a message indicating completion appears.

6. After the chart loading is completed, the equipment automatically restarts itself. After the start-up is completed, a message appears about chart installation:
Free chart: "Installation is successful for 1 area. No further action is required."
For fee chart: "Installation is successful for 1 area. But 1 area need a valid Unlock Code. Please, go to Charts Catalog menu page to enter missing Unlock Code(s)."
7. Push the **RotoKey**. For free chart, no further operation is necessary. For the for fee chart, go to step 8.
8. Press the **MENU** key, then select Chart and [Data Catalog].
9. Rotate the **RotoKey**, and a blue rectangle appears in the chart list.
10. Push the **RotoKey**.
11. Rotate the **RotoKey** to select the chart you added.
For the for fee chart [Locked] is displayed. This means the chart cannot be used in its current state.

12. Push the **RotoKey** and the pop-up window shown right appears.

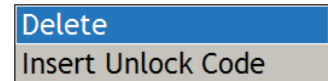

13. Rotate the **RotoKey** to select [Insert Unlock Code], then push the **RotoKey**. The window shown below appears.

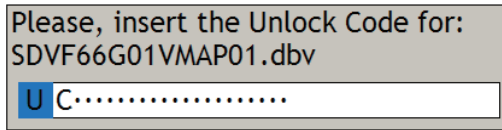

14. Use the **RotoKey** to enter the unlock code.

13.7.3 How to Add a Chart

You can purchase the charts for your area from the NavNet web site www.navnet.com. Download a chart to a SD card then follow the instructions in the procedure on this page.

13.7.4 How to Delete a Chart

You can delete unnecessary charts from the hard drive. For example, you do not require a chart of Europe because you navigate along the US coastline.

1. Press the **MENU** key to open the menu.
2. Open the [Chart-Data Catalog] menu.
3. Rotate the **RotoKey** until the blue rectangle is about the chart list.
4. Push the **RotoKey**.
5. Rotate the **RotoKey** to select a chart. A preview of the chart appears at the upper 1/4 of the screen.
6. Push the **RotoKey** and the [Delete] pop-up appears.
7. Push the **RotoKey**. The message shown below appears.

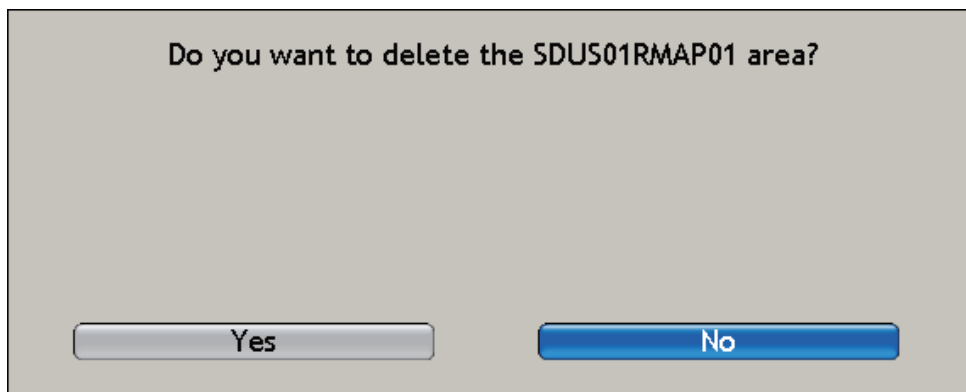

8. Rotate the **RotoKey** to select Yes then push the key to delete the chart.
9. Press the **MENU** key to close the menu.

13. HOW TO ADJUST SETTINGS

This page is intentionally left blank.

14. MAINTENANCE, TROUBLE-SHOOTING

This chapter has information about maintenance and troubleshooting that the user can follow to care for the equipment.

	WARNING
	<p>ELECTRICAL SHOCK HAZARD Do not open the equipment.</p> <p>Only qualified persons can work inside the equipment.</p>

NOTICE
<p>Do not apply paint, anti-corrosive sealant or contact spray to coating or plastic parts of the equipment.</p> <p>Those items contain organic solvents that can damage coating and plastic parts, especially plastic connectors.</p>

14.1 Maintenance

Routine maintenance helps keep your equipment in good condition and prevents future problems. Check the items shown in the table below to help keep your equipment in good condition for years to come.

Routine maintenance

Check item	Check point	Remedy
Cables	Check that all cables are fastened. Check the cables for corrosion.	Connect the cables that have loosened. Replace any damaged cables.
Cabinet	Dust on the cabinet	Remove dust with a dry clean cloth. Do not use commercial cleaners to clean the equipment. Those cleaners can remove paint and markings.
LCD	Dust on the LCD	Wipe the LCD carefully to prevent scratching, using tissue paper and an LCD cleaner. To remove dirt or salt deposits, use an LCD cleaner, wiping slowly with tissue paper so as to dissolve the dirt or salt. Change paper frequently so the salt or dirt will not scratch the LCD. Do not use solvents such as thinner, acetone or benzene for cleaning.
Radar antenna	Dirt on the radar antenna can reduce the sensitivity.	Clean the radiator (or radome) with a cloth wetted with freshwater. Do not use commercial cleaners to clean the radiator. Those cleaners can remove paint and markings.

14.2 Fuses

The MFD has a fuse that protects the MFD from high electric current and equipment fault. If you cannot turn on the power, check the fuse to see if it has blown. Find the reason for the blown fuse before you replace the fuse. If the fuse blows again after the replacement, contact your dealer for information. A wrong fuse can damage the equipment.



Fuse information

Name	Type	Code No.	Remarks
Fuse	FGB0-A 125V 5A PBF	000-155-853-10	For MFD8, 24V
Fuse	FGBO-A 125V 10A PBF	000-155-826-10	For MFD8, 12V
Fuse	FGBO-A 125V 10A PBF	000-155-826-10	For MFD12, 24V
Fuse	FGB0 125V 20A PBF	000-155-780-10	For MFD12, 12V

14.3 The Magnetron

When the life of the magnetron is reached, the targets do not appear on the radar display. If long-range performance appears to have decreased, contact a FURUNO agent or dealer about replacement of the magnetron.

Magnetron information

Radar Sensor	Magnetron	Code No.
DRS2D	E3590	000-164-574-10
DRS4D	E3571	000-146-867-00
DRS4A	MAF1421B	000-158-786-10
DRS6A	MAF1422B	000-158-788-10
DRS12A	E3566	000-164-418-10
DRS25A	MG5436(E2V)	000-140-762-10

14.4 Troubleshooting

This section provides simple troubleshooting procedures which the user can follow to restore normal operation. If you cannot restore normal operation, do not check inside the unit. Have a qualified technician check the equipment.

14.4.1 General Troubleshooting

Problem	Remedy
You can not turn on the power.	<ul style="list-style-type: none"> • Check for blown fuse. • Check that the power connector is fastened. • Check for corrosion on the power cable connector. • Check for damaged power cable. • Check battery for correct voltage output (10.8 to 31.2 V).
There is no response when a key is pressed.	Turn off and on the power. If you do not get a response, the key is damaged. Contact your dealer for instructions.
The message "HDD warning. Please contact a dealer." appears at start up.	The hard disk has been used 18,000 hours. See your dealer for details.

14.4.2 Radar Troubleshooting

Problem	Remedy
Nothing appears on the display after you press the power switch followed by the GAIN/TX key to transmit.	<ul style="list-style-type: none"> • Make sure to push the key for more than one second. • Check that the antenna cable is fastened. • Check if the radar source is correct.
Marks and legends appear, but echoes do not appear.	Check that the antenna cable is fastened.
Picture is not updated or the picture freezes.	<ul style="list-style-type: none"> • Check antenna cable. • If the picture freezes, turn the display unit on and off.
You tuned the receiver, but the sensitivity is weak.	Have a technician check the magnetron.
You changed the range, but the radar picture does not change.	<ul style="list-style-type: none"> • Try to hit the RANGE keys again. • Turn the display unit off and on.
Poor discrimination in range.	Adjust the Sea control.
True motion mode is not operating correctly.	<ul style="list-style-type: none"> • Select the true motion mode. • Check if the heading and speed are input.
Range rings are not displayed.	Use the Rings soft control to activate the range rings.
You pressed the GAIN/TX key to transmit. The "TX screen" appears, but the radar goes into stand-by.	This problem indicates that the overload protection has activated. To restore normal operation, turn off all equipment in the NavNet network. Wait a few seconds then turn on all the equipment.

14.4.3 Chart Plotter Troubleshooting

Problem	Remedy
Position is not fixed.	Check that antenna connector is fastened and navigator is correctly connected.
The track of your vessel is not plotted.	Check that the track is turned on. (Put the cursor on the boat icon to open the pop-up menu and check that "Tracks" is on.)

14.4.4 Fish Finder Troubleshooting

Problem	Remedy
You selected a fish finder display with the DISP key, but no picture appears.	<ul style="list-style-type: none"> • Check that the signal cable for the fish finder is fastened. • Check that the fish finder source is correct. • Check that the network fish finder is properly connected.
Marks and characters appear, but no picture appears.	Check that the transducer cable is connected.
Picture appears but zero line does not appear.	<ul style="list-style-type: none"> • The picture is shifted. Check the shift setting. • Check if draft is set to zero (Menu→System→Calibration).
The picture sensitivity is too low.	<ul style="list-style-type: none"> • Check the gain setting in manual operation. • The marine life or air bubbles can attach to the transducer face. • Bottom is too soft to return an acceptable echo.
The depth indication does not appear.	<ul style="list-style-type: none"> • For manual operation, adjust gain and range to display the bottom echo (in reddish-brown). • Adjust bottom level HF/LF: Menu→System→DFF1/BBDS1/DFF1-UHD, DFF3/FCV, ETR-6/10N, or ETR-30N
Noise or interference shows on the display.	<ul style="list-style-type: none"> • Make sure the transducer cable is not near the engine of the boat. • Check the ground. • There can be another fish finder on another that has the same frequency as your fish finder. • Try to adjust the interference rejector: Menu→Fish Finder→DFF1/BBDS1/DFF1-UHD, DFF3/FCV, ETR-6/10N, or ETR-30N→Interference Rejector).
The water temperature graph appears, but the data is incorrect.	Check that sensor cable is fastened.

14.5 GPS Status Display

The GPS status display shows the signal strength and location in the sky for each GPS satellite received.

1. Open the [System-General] menu.
2. Click the [GPS Status] button to show the GPS status display.
3. Push the **RotoKey** to close the display and return to the previous display.

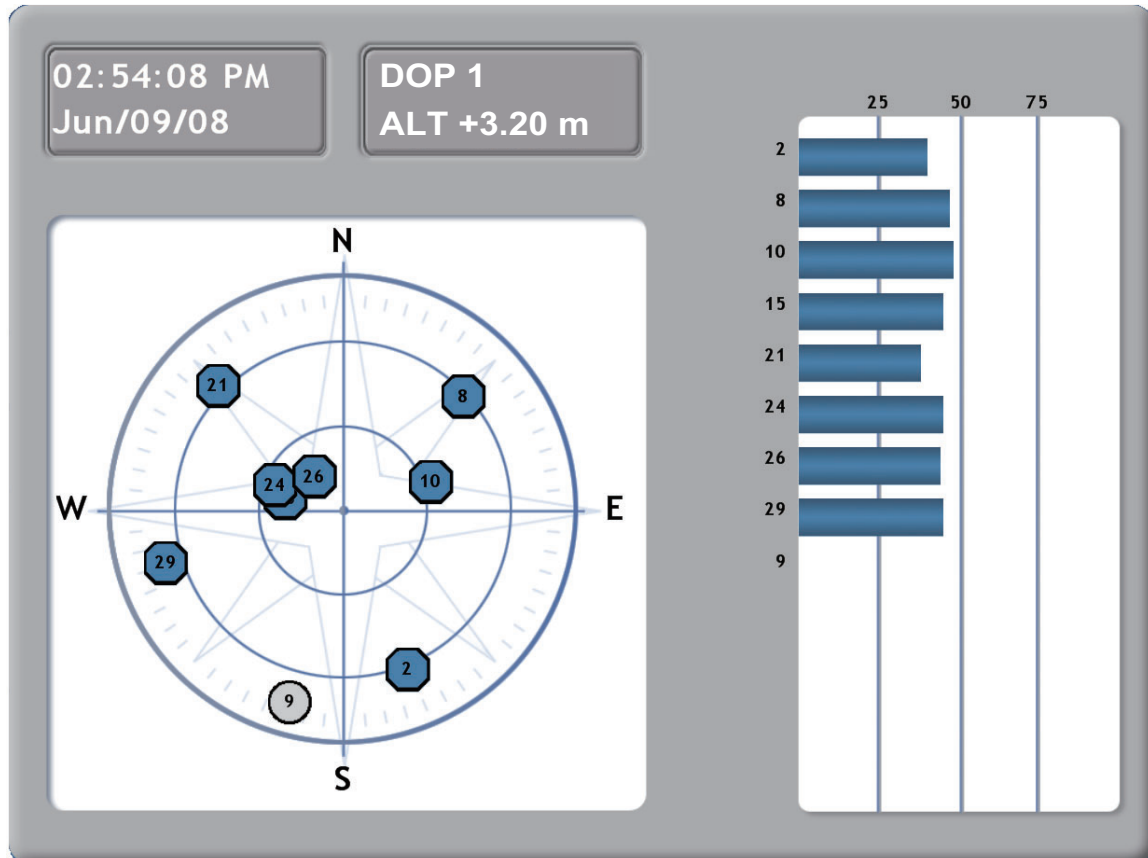

- The date and time appear at the top-left corner of the display.
- DOP (Dilution of Precision) describes the geometric strength of satellite configuration on GPS accuracy. When visible satellites are close together in the sky, the geometry is weak and the DOP value is high, When the satellites are far away from one another, the geometry is strong and the DOP value is low.
- ALT is the height of your GPS antenna above the surface of the water.
- The diagram at the left part of the screen shows the information shown below.
 - Estimated position of each GPS satellite.
 - Satellites used to find position are marked with a blue octagon.
 - Satellites not used to find position are marked with a gray circle.
 - The strength of the RX signal from each satellite is shown with a bar at the right side of the display. If the signal level of a satellite is 40 or higher, that satellite is used to find your position.

This page is intentionally left blank.

APPENDIX 1 MENU TREE

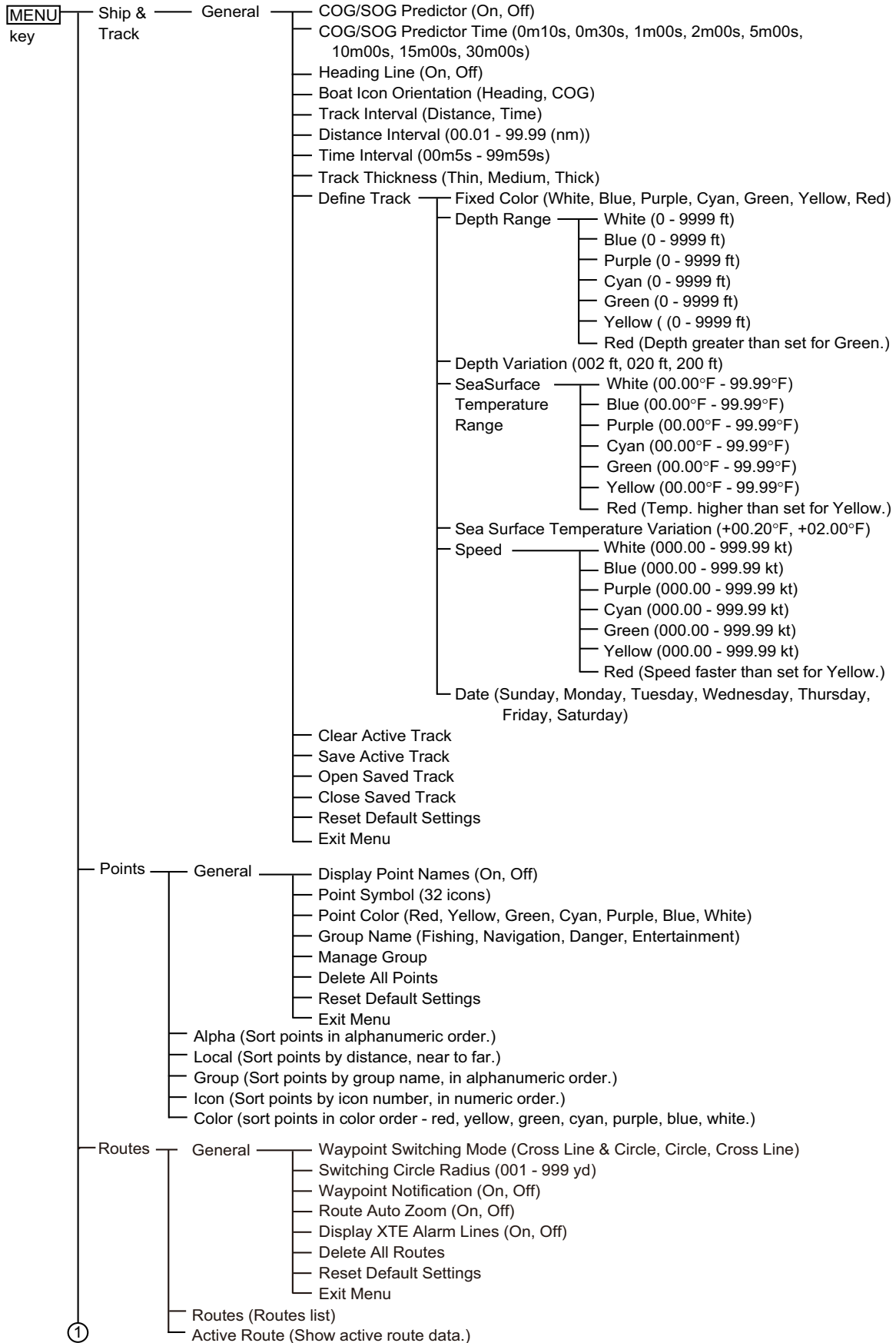

APPENDIX 1 MENU TREE

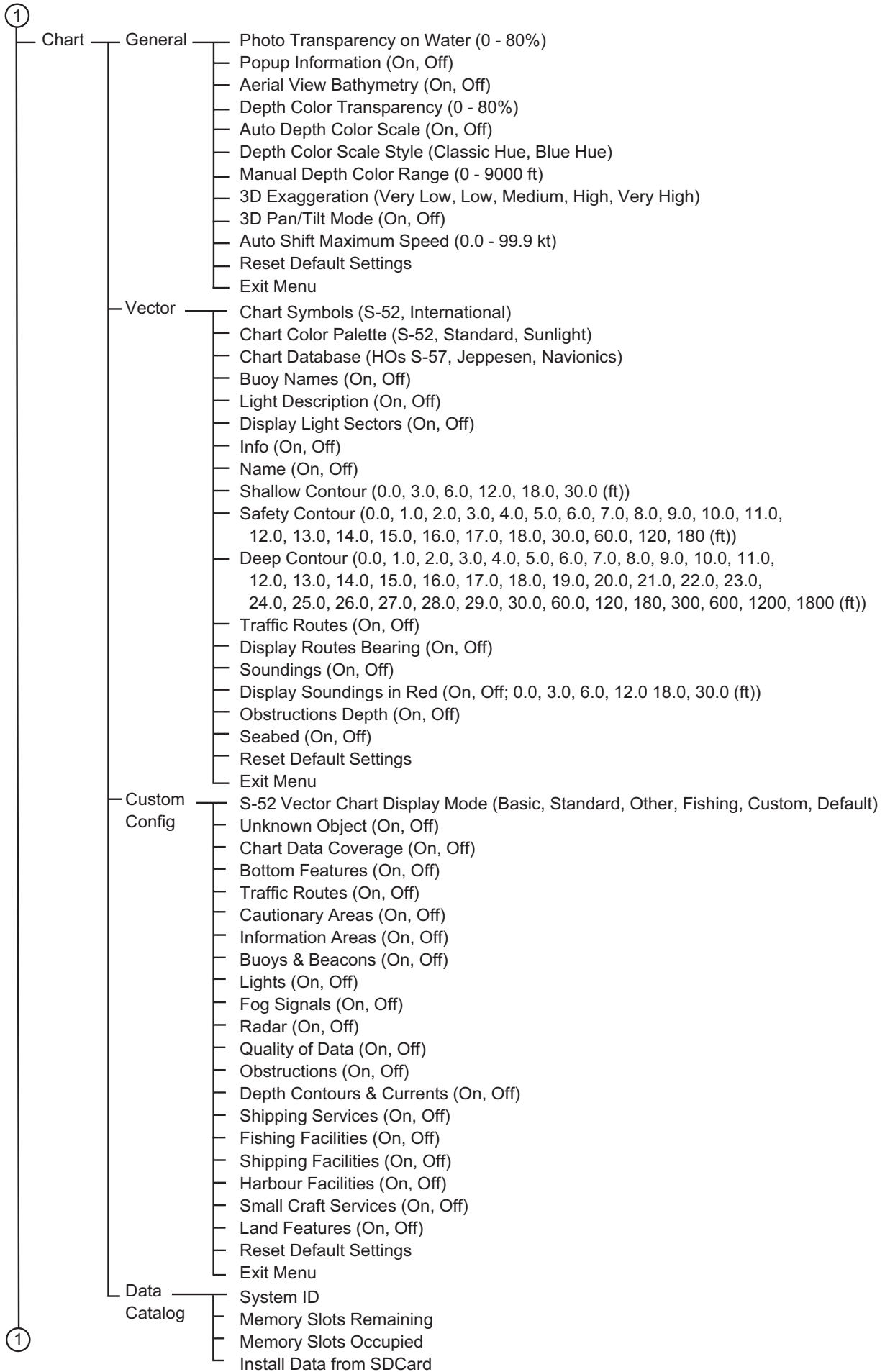

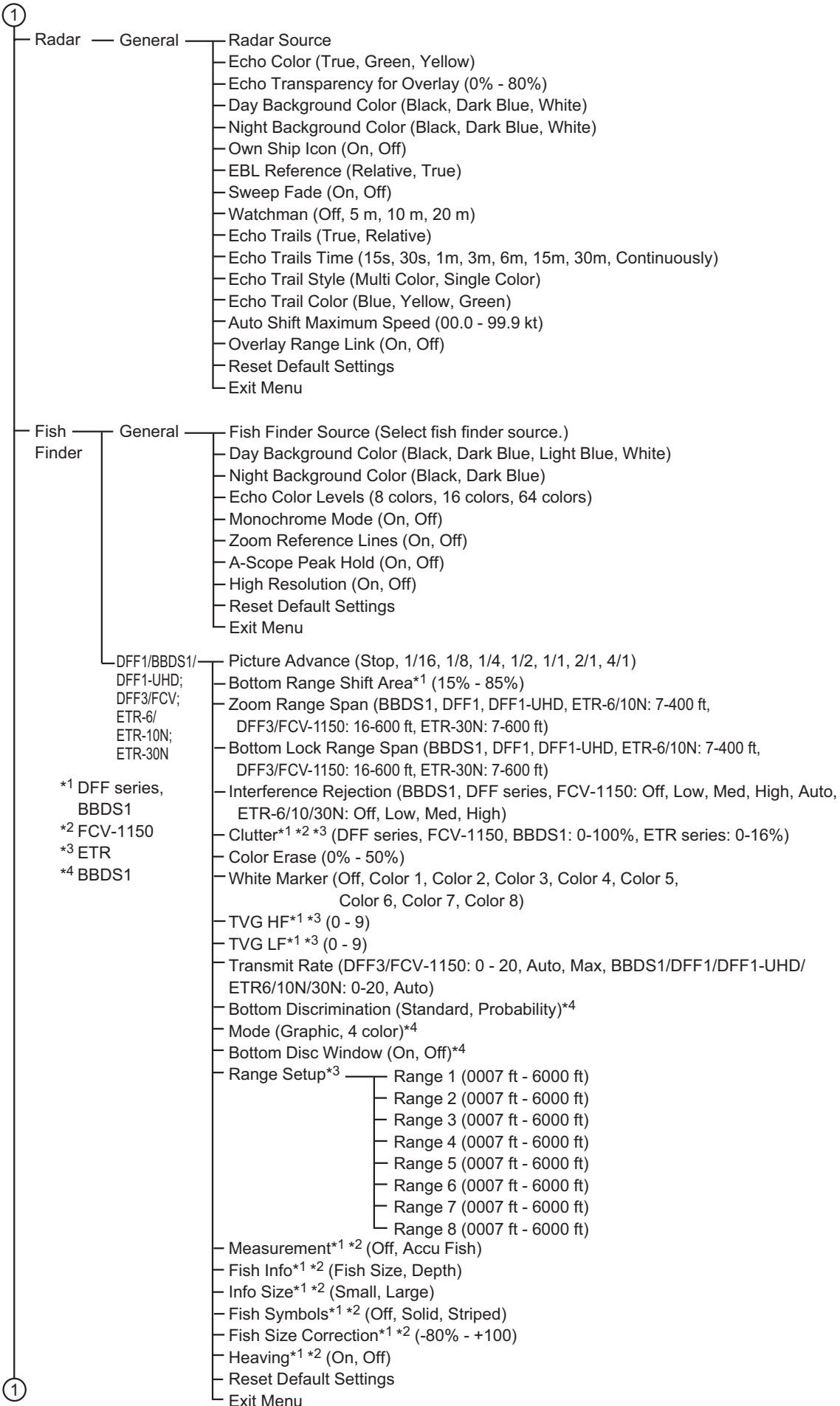

APPENDIX 1 MENU TREE

①

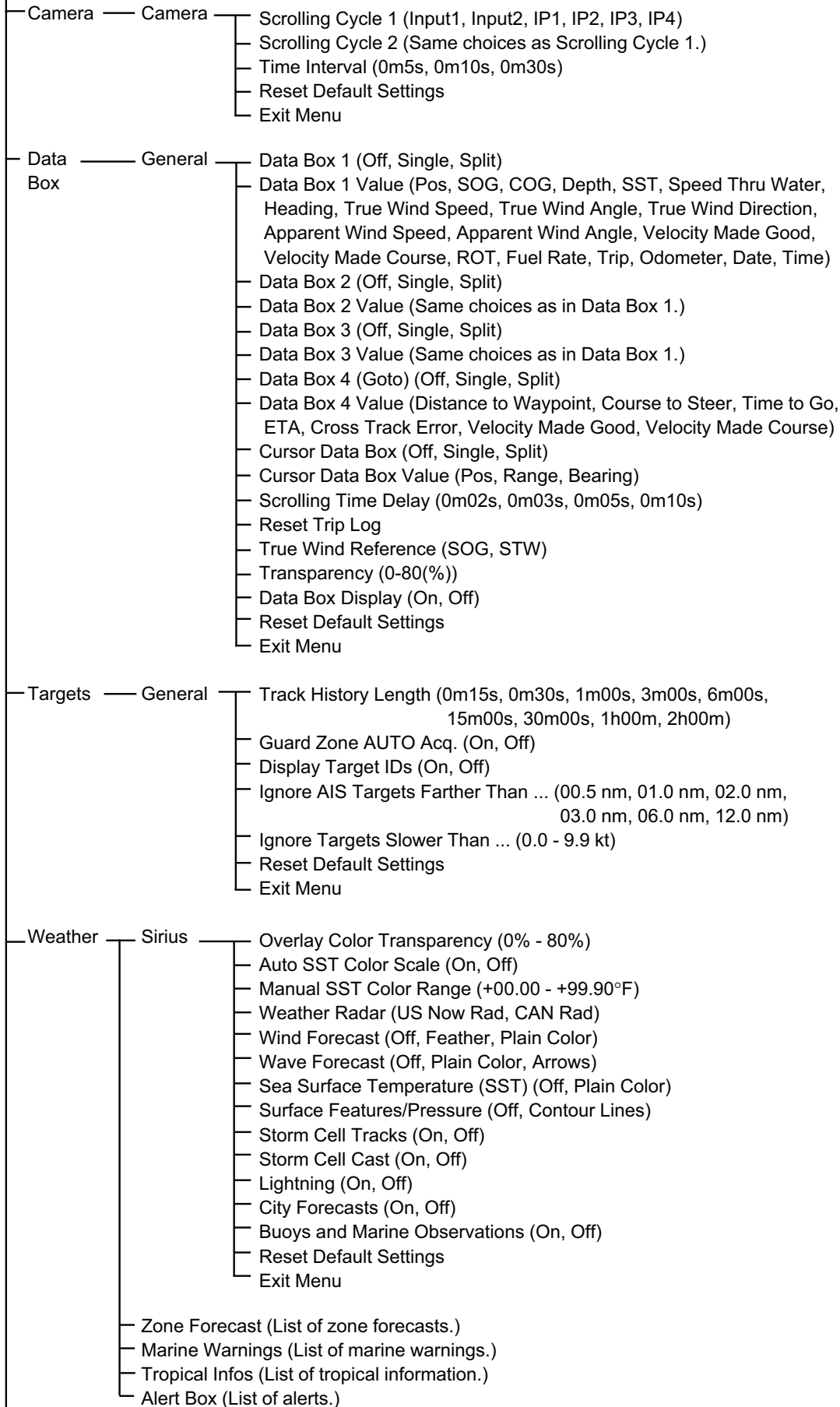

①

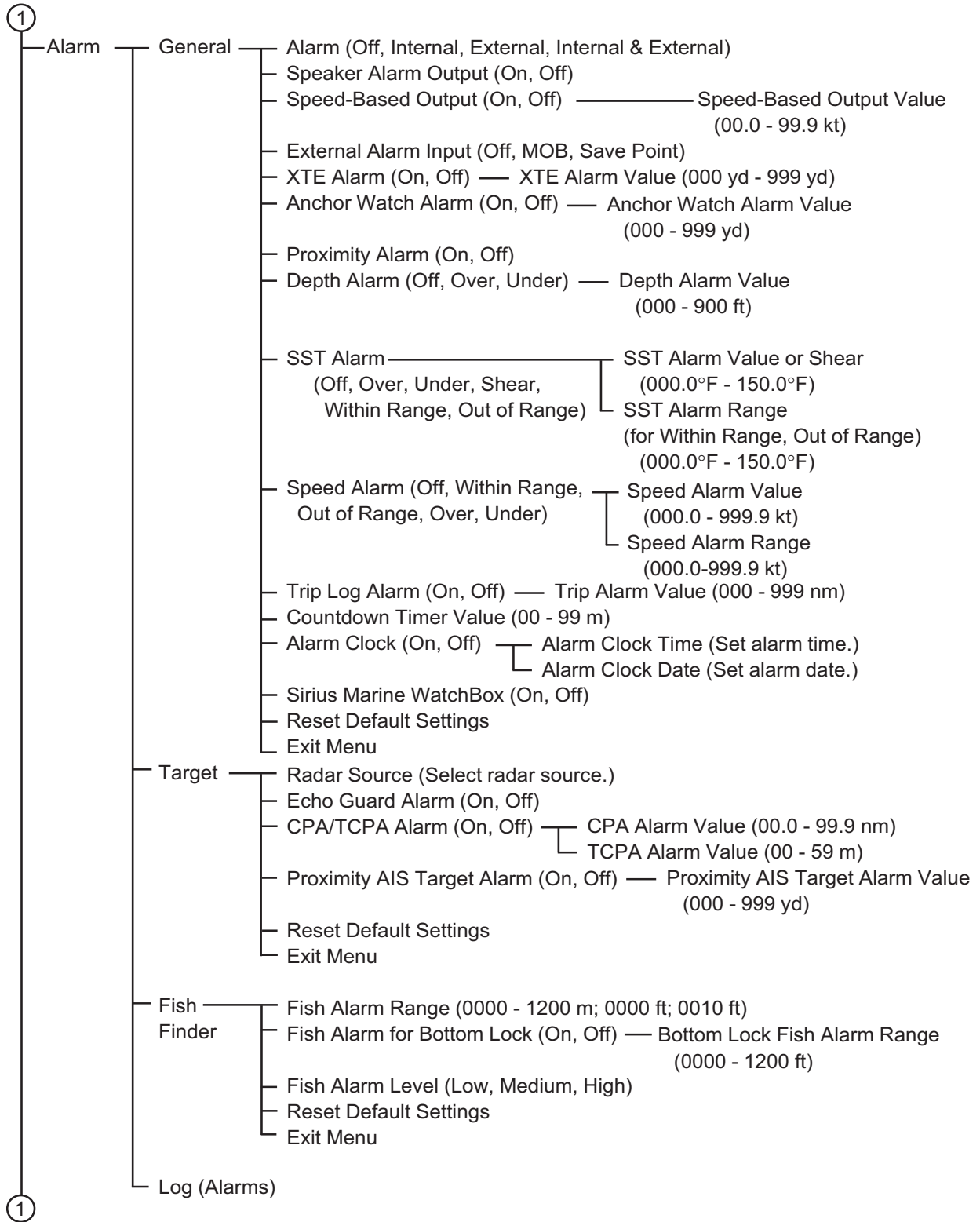

APPENDIX 1 MENU TREE

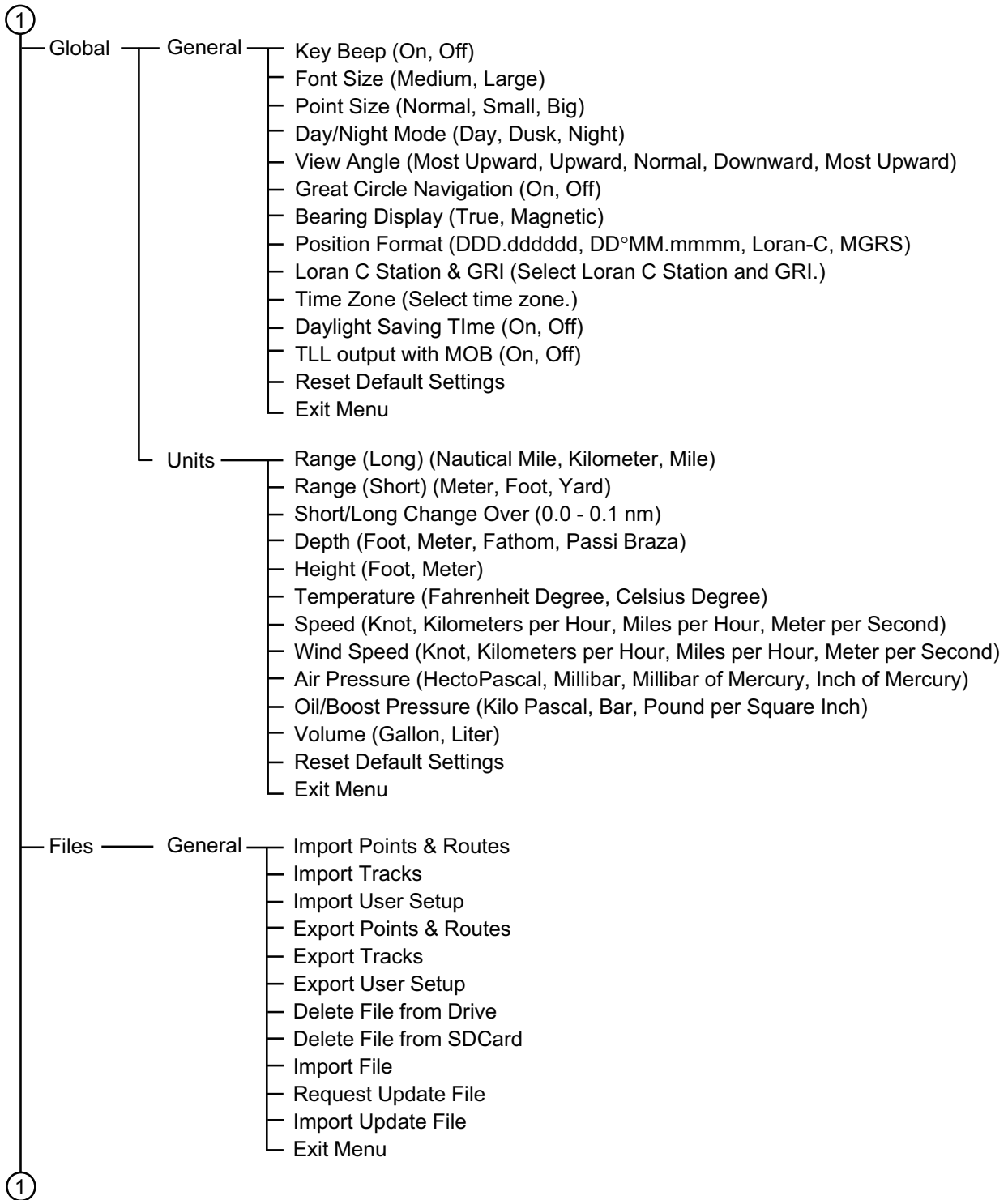

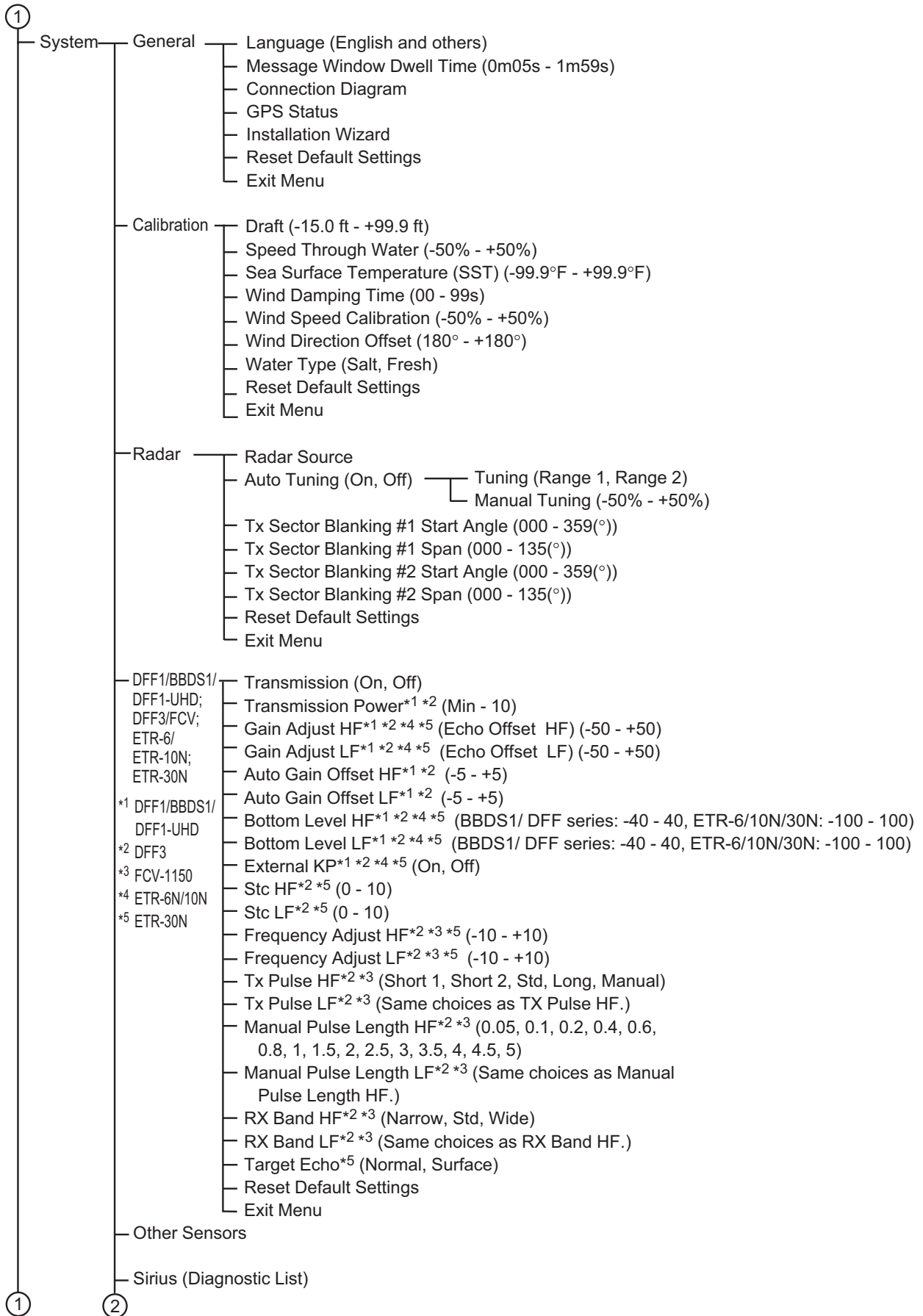

APPENDIX 1 MENU TREE

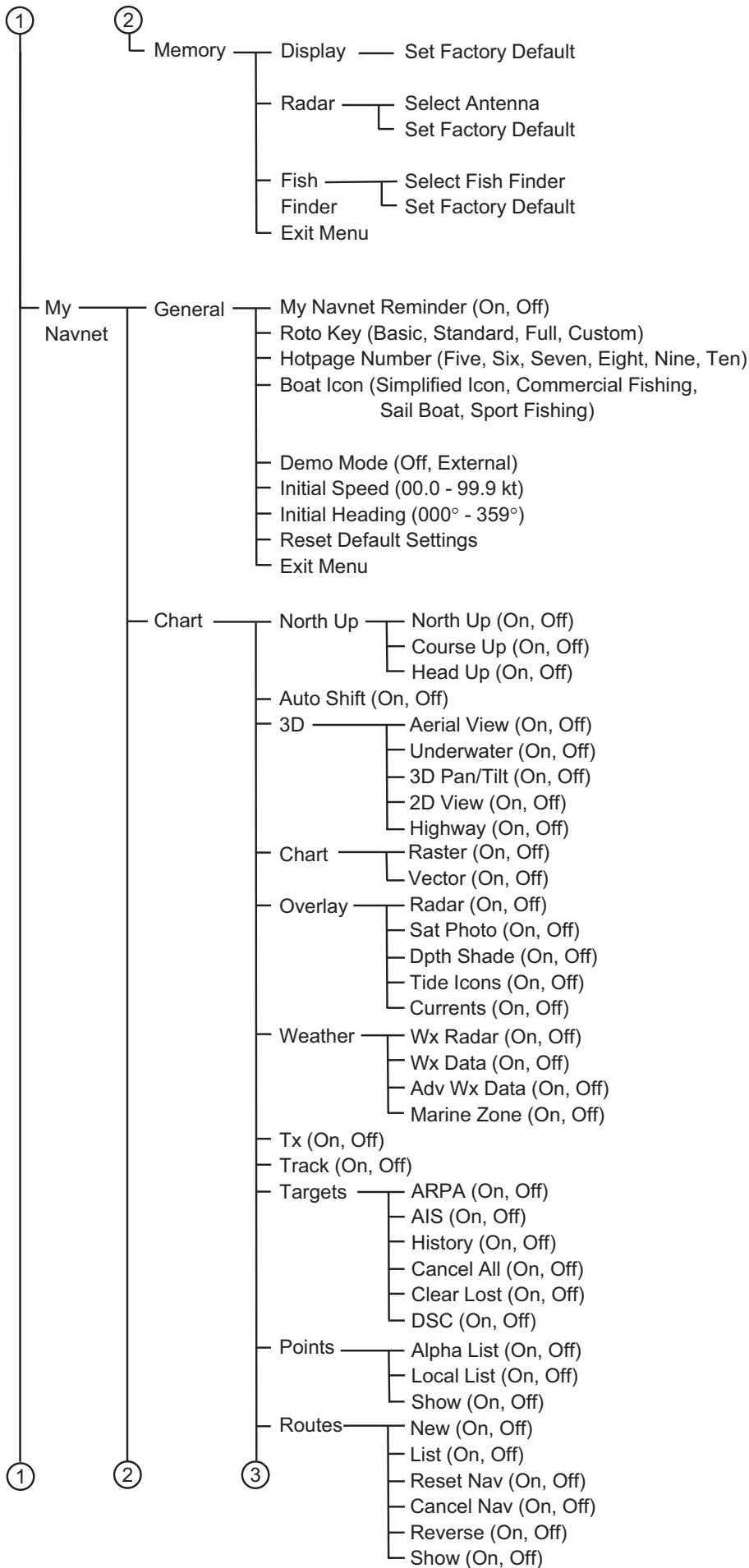

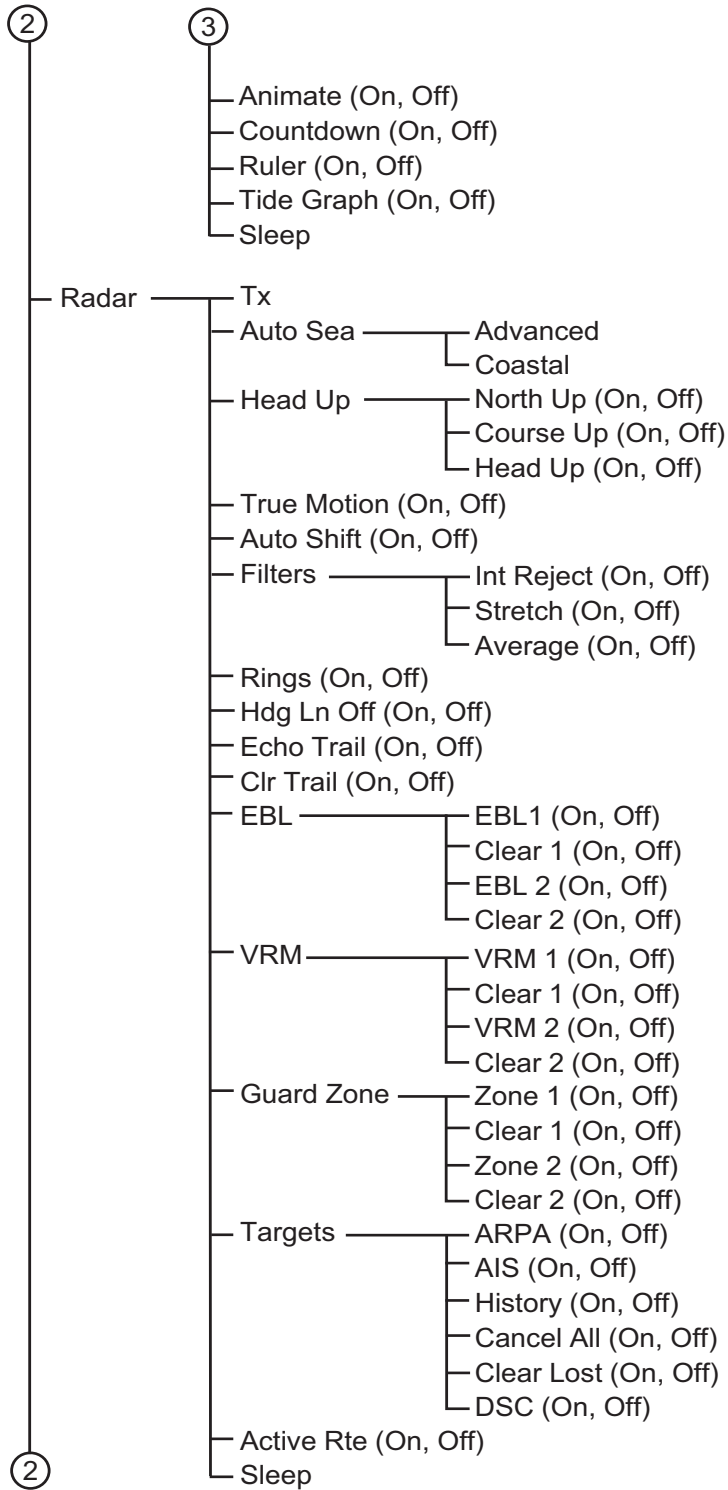

APPENDIX 1 MENU TREE

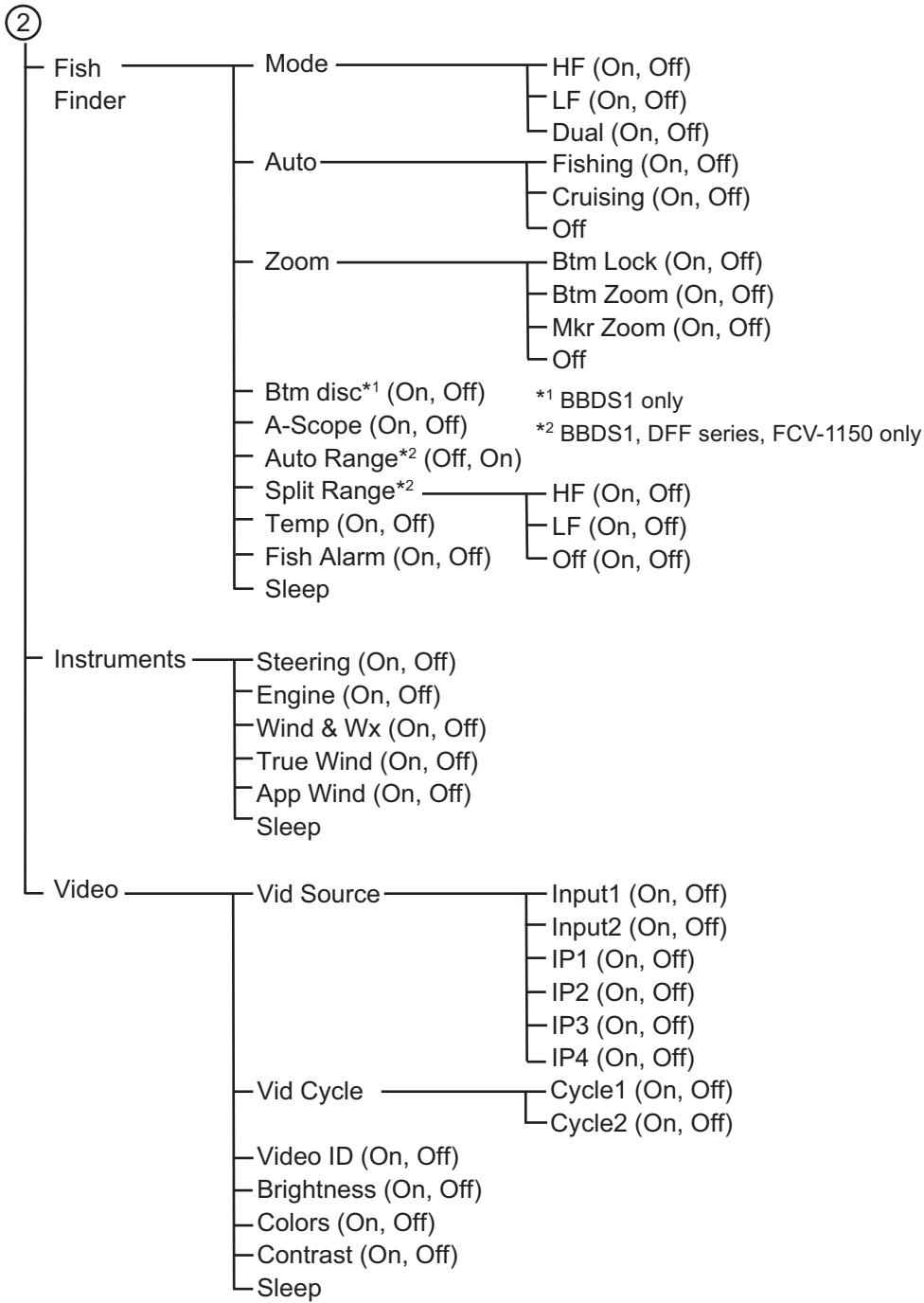

**SPECIFICATIONS OF MULTI FUNCTION DISPLAY
MFD8**

1 GENERAL

- 1.1 Display 8.4-inch color LCD, 170.2 x 128.2mm
- 1.2 Resolution 640 x 480 dots (VGA)
- 1.3 Indication system Raster-scan, non-interlace, Horizontal: 31.5kHz, Vertical: 60Hz
- 1.4 Brightness 700 cd/m² typical
- 1.5 Display colors 65,536 colors (plotter), 64 colors (echo), 32 colors (radar)

2 PLOTTER FUNCTION

- 2.1 Display mode Course plot, NAV data, NAV instrument data*, Engine monitoring*
- 2.2 Projection Mercator
- 2.3 Usable area 85° latitude or below
- 2.4 Memory capacity Track: 10,000 points, Point: 2,000 points
Route: 200 courses w/ 100 waypoints each
- 2.5 MOB 1 point
- 2.6 Language Chinese, Dutch, Danish, Finish, French, German, Italian, Japanese, Norwegian, Portuguese, Spanish, Swedish, UK/US
- 2.7 Alarms Waypoint notification and anchor watch, Cross track error, Proximity, Clock, Ship's speed in/out*, Sea surface temperature*, Trip*, Fish*, Bottom lock fish*
*: External data required

3 RADAR INDICATION

- 3.1 Presentation mode Head-up, Course-up*, North-up*, Relative motion, True motion**
*: Heading data required, **: Heading and speed data required
- 3.2 Echo trail Interval: 15/30s, 1/3/6/15/30 min. and continuous
- 3.3 ARPA Tracks: 30 targets, CPA/TCPA alarm

4 INTERFACE

- 4.1 Number of port
 - LAN 1 ports, Ethernet 100Base-TX
 - NMEA NMEA0183: 3 ports, CAN bus: 1 port (LEN=1)
 - USB 1 ports, USB2.0
 - VGA output 1 ports, DVI-D
 - Video input 2 ports, NTSC/PAL
 - SD card slot 2 slots
- 4.2 NMEA0183 (Ver.1.5/2.0/3.0) sentences
 - Input DBK, DBS, DBT, DPT, DTM, GGA, GLL, GNS, HDG, HDM, HDT,

		MDA, MTW, MWV, RMA, RMC, ROT, VDM, VHW, VTG, VWR, VWT, ZDA
Output		AAM, APB, BOD, BWC/BWR, DBT, DPT, DTM, GGA, GLL, GNS, GTD, HDG, HDT, MTW, MWV, RMA, RMB, RMC, ROT, TTM, VHW, VTG, WPL, XTE, ZDA, ZTG
4.3 CAN bus PGN (NMEA2000)		
Input		059392/904, 060928, 061184, 065280, 126208/720/992/996, 127245/250/251/257/488/489, 128259/267, 129025/026/029/033/044/538/540, 130306/310/311/577/817/818/819/820
Output		059392/904, 060928, 061184, 126208/720/992/996, 127245/251/258, 128259/267, 129025/026/029/033/283/284, 130306/310/311/577/816/817/818/819
4.4 Ethernet		
I/O sentences		Same as NMEA0183 format
5 POWER SUPPLY		
5.1 Multi function display		12-24 VDC: 2.3-1.2A
w/ radar sensor		DRS2D: 6.1-3.0 A, DRS4D: 6.4-3.1 A
5.2 Rectifier (option)		
PR-62		100/110/220/230 VAC, 1 phase, 50/60Hz
RU-3423		100-115/220-230 VAC, 1 phase, 50/60Hz
6 ENVIRONMENTAL CONDITION		
6.1 Ambient temperature		-15°C to +55°C
6.2 Relative humidity		93% or less at 40°C
6.3 Degree of protection		IP56 (front panel), IP20 (rear side)
6.4 Vibration		IEC 60945 Ed.4
7 COATING COLOR		
		N2.5 (fixed)

**SPECIFICATIONS OF MULTI FUNCTION DISPLAY
MFD12**

1 GENERAL

- 1.1 Display 12.1-inch color LCD, 246 x 184.5 mm
- 1.2 Resolution 800 x 600 dots (SVGA)
- 1.3 Indication system Raster-scan, non-interlace, Horizontal: 35.1kHz, Vertical: 60Hz
- 1.4 Brightness 1,100 cd/m² typical
- 1.5 Display colors 65,536 colors (plotter), 64 colors (echo), 32 colors (radar)

2 PLOTTER FUNCTION

- 2.1 Display mode Course plot, NAV data, NAV instrument data*, Engine monitoring*
 - 2.2 Projection Mercator
 - 2.3 Usable area 85° latitude or below
 - 2.4 Memory capacity Track: 10,000 points, Point: 2,000 points
Route: 200 courses w/ 100 waypoints each
 - 2.5 MOB 1 point
 - 2.6 Language Chinese, Dutch, Danish, Finish, French, German, Italian, Japanese, Norwegian, Portuguese, Spanish, Swedish, UK/US
 - 2.7 Alarms Waypoint notification and anchor watch, Cross track error, Proximity, Clock, Ship's speed in/out*, Sea surface temperature*, Trip*, Fish*, Bottom lock fish*
- *: External data required

3 RADAR INDICATION

- 3.1 Presentation mode Head-up, Course-up*, North-up*, Relative motion, True motion**
*: Heading data required, **: Heading and speed data required
- 3.2 Echo trail Interval: 15/30s, 1/3/6/15/30 min. and continuous
- 3.3 ARPA Tracks: 30 targets, CPA/TCPA alarm

4 INTERFACE

- 4.1 Number of port
 - LAN 1 ports, Ethernet 100Base-TX
 - NMEA NMEA0183: 3 ports, CAN bus: 1 port (LEN=1)
 - USB 1 ports, USB2.0
 - VGA output 1 ports, DVI-D
 - Video input 2 ports, NTSC/PAL
 - SD card slot 2 slots
- 4.2 NMEA0183 (Ver.1.5/2.0/3.0) sentences
 - Input DBK, DBS, DBT, DPT, DTM, GGA, GLL, GNS, HDG, HDM, HDT,

- | | |
|-----------------------------------|--|
| | MDA, MTW, MWV, RMA, RMC, ROT, VDM, VHW, VTG, VWR, VWT, ZDA |
| Output | AAM, APB, BOD, BWC/BWR, DBT, DPT, DTM, GGA, GLL, GNS, GTD, HDG, HDT, MTW, MWV, RMA, RMB, RMC, ROT, TTM, VHW, VTG, WPL, XTE, ZDA, ZTG |
| 4.3 CAN bus PGN (NMEA2000) | |
| Input | 059392/904, 060928, 061184, 065280, 126208/720/992/996, 127245/250/251/257/488/489, 128259/267, 129025/026/029/033/044/538/540, 130306/310/311/577/817/818/819/820 |
| Output | 059392/904, 060928, 061184, 126208/720/992/996, 127245/251/258, 128259/267, 129025/026/029/033/283/284, 130306/310/311/577/816/817/818/819 |
| 4.4 Ethernet | |
| I/O sentences | Same as NMEA0183 format |

5 POWER SUPPLY

- | | |
|---------------------------------|--|
| 5.1 Multi function display | 12-24 VDC: 3.4-1.7A |
| w/ radar sensor | DRS2D: 7.2-3.6 A, DRS4D: 7.6-3.7 A, DRS4A: 11.0-5.3 A, DRS6A: 12.0-5.7 A |
| 5.2 Rectifier (RU-3423, option) | 100-115/220-230 VAC, 1 phase, 50/60Hz |

6 ENVIRONMENTAL CONDITION

- | | |
|--------------------------|--------------------------------------|
| 6.1 Ambient temperature | -15°C to +55°C |
| 6.2 Relative humidity | 93% or less at 40°C |
| 6.3 Degree of protection | IP56 (front panel), IP20 (rear side) |
| 6.4 Vibration | IEC 60945 Ed.4 |

7 COATING COLOR

N2.5 (fixed)

INDEX

Numerics

- 3D display
 - description 3-1
 - exaggeration 3-4

A

- ACCU-FISHTM
 - considerations 7-19
 - setting up 7-20
- Adv Wx Data soft control 3-8
- Advanced weather data 3-8
- Advanced weather overlay 3-8
- AIS
 - ignoring 12-3
 - lost target 12-2
 - show, hide 12-1
 - target data 12-4
 - target symbols 12-2
 - track history display 12-4
- Alarm clock 2-14
- Alarm log 2-17
- Alarms
 - alarm clock 2-14
 - anchor watch 2-13
 - audio options 2-16
 - countdown alarm 2-14
 - CPA/TCPA (ARPA) 6-32
 - CPA/TCPA alarm 6-32
 - depth 2-14
 - fish 7-17
 - log 2-17
 - Proximity AIS target alarm 12-2
 - proximity alarm 2-14
 - setting chart plotter related 2-15
 - speed 2-14
 - SST 2-14
 - trip alarm 2-14
 - XTE 2-13
- Alarms log 2-17
- Anchor watch alarm 2-13
- Animate soft control 3-10
- Animation overlay 3-10
- Apparent wind display 10-6
- ARPA
 - acquiring target manually 6-30
 - acquisition area 6-33
 - cancelling target 6-31
 - CPA/TCPA alarm 6-32
 - disabling 6-29
 - lost target 6-31
 - showing 6-29
 - target data 6-31
 - track history display 6-34
- A-scope display 7-6

- Auto shift (radar) 6-20
- Avoidance circle 4-9

B

- Background color
 - fish finder 7-22
 - radar 6-22
- Bearing display 13-13
- Bearing measurement
 - chart plotter 2-8
 - radar 6-10
- Boat icon
 - chart plotter display 2-6
 - configuration 1-20
 - radar 6-21
- Bottom discrimination display 7-7, 7-8
- Bottom features 2-12
- Bottom level 13-18
- Bottom lock display 7-5
- Bottom lock range 7-23
- Bottom range shift area 7-23
- Bottom zoom display 7-5
- Brilliance 1-5
- Buoy names 2-10
- Buoys 11-11
- Buoys and beacons 2-12

C

- Calibrations 13-16
- Camera/Video
 - cycling inputs 9-2
 - cycling period 9-3
 - image adjustment 9-4
 - input source 9-2
 - show 9-1
 - video ID 9-3
- Cautionary areas 2-12
- Chart color palette 2-10
- Chart data coverage 2-12
- Chart database 2-10
- Chart information 2-10
- Chart-Custom Config menu 2-12
- Charts
 - adding 13-25
 - browsing 13-23
 - cartographic setup 2-10
 - chart scale 2-4
 - deleting 13-25
 - fishing 2-1
 - moving 2-5
 - object information 2-8
 - orientation mode 2-5
 - raster 2-1
 - selecting 2-1
 - updating 13-24

INDEX

- vector2-1
- Chart-Vector menu.....2-10
- City forecasts 11-10
- Clutter (fish finder)7-11
- COG/SOG predictor2-6
- Color bar7-27
- Color erase (fish finder)7-15
- Connection diagram 13-15
- Control description 1-3
- Countdown timer 2-14
- CPA/TCPA alarm 6-32
- CTRL key 1-6, 6-23
- Currents soft control.....3-14
- Cursor 1-11
- D**
- Data boxes
 - customizing 13-7
 - selecting data for..... 1-15
 - show, hide all 13-9
 - transparency of 13-9
- Day/night mode..... 13-13
- Daylight saving time 13-13
- Deleting data and files 8-4
- Demo mode 13-21
- Depth alarm 2-14
- Depth contours and currents.....2-12
- Depth measurement 7-14
- Depth shading overlay
 - depth color scale.....3-5
 - depth color transparency.....3-5
- Dimmer 1-5
- DISP key 1-6
- Dpth Shade soft control3-5
- Draft 13-16
- DSC
 - hiding..... 1-25
 - information 1-25
 - list..... 1-26, 1-27
 - operations with DSC marker 1-26
 - showing..... 1-25
- Dual frequency display.....7-3
- Dual radar6-23
- E**
- EBL
 - bearing reference6-11
 - erasing6-11
 - measuring bearing with6-10
- Echo color (radar)6-22
- Echo stretch6-19
- Echo trails
 - hiding/showing6-17
 - trail color.....6-18
 - trail reference6-18
 - trail time.....6-17
- Echo transparency (radar overlay).....3-11
- Engine display 10-4
- Exaggeration (3D display).....3-4
- Exporting data and files 8-3
- External KP 13-19
- F**
- FA-30, FA-50 1-24
- FAX-30 1-23
- Files menu 8-1
- Filters soft control.....6-19
- Fish alarm
 - activate, deactivate7-18
 - sensitivity.....7-18
 - setting.....7-17
- Fishing facilities.....2-12
- Flyover 5-11
- Fog signals.....2-12
- Font size 13-13
- Frequency selector icon.....7-2
- Fuse replacement 14-2
- G**
- Gain
 - fish finder.....7-11
 - offset (fish finder) 13-18, 13-20
 - radar.....6-2
- GAIN/TX key
 - fish finder.....7-11
 - radar.....6-1
- Global-General menu.....13-12
- Global-Units menu 13-14
- GO TO/LIST key 4-3
- GPS status display.....14-5
- Great circle display.....13-13
- Guard zone
 - clearing.....6-16
 - setting.....6-15
- H**
- Heading line
 - chart plotter2-6
 - radar.....6-13
- Heaving7-24
- High resolution (fish finder)7-22
- Highway display 3-3
- Hot pages.....13-9
- I**
- Icon size 13-13
- Importing data and files.....8-4
- Information areas 2-12
- Instrument display
 - apparent wind.....10-6
 - engine10-4
 - selecting10-3
 - showing10-2
 - steering10-3
 - true wind.....10-6
 - wind and weather10-5
- Instrument showing10-2
- Interference
 - fish finder.....7-13

- radar 6-14
- K**
- Key beep 13-13
- L**
- Land features 2-12
- Language 1-19, 13-15
- Light description 2-10
- Light sectors 2-10
- Lightning 11-9
- Lights 2-12
- Loran C station 13-13
- Lost target 6-31
- M**
- Magnetron replacement 14-2
- Maintenance 14-1
- Manual tuning (radar) 13-17
- Marine observations 11-11
- Marine warning 11-13
- Marine WatchBox 11-14
- Marine zone forecast 11-12
- Marine zone overlay 3-9
- Marine Zone soft control 3-9
- Marker zoom display 7-4
- MENU key 1-16
- Menu overview 1-16
- Menu tree AP-1
- MOB (ManOverBoard)
- erasing 1-22
- information 1-22
- marking 1-21
- Monochrome mode (fish finder) 7-22
- Multiple echoes (radar) 6-25
- My NavNet reminder 13-21
- N**
- North marker 6-6
- O**
- Obstructions and seabed 2-12
- Orientation mode
- chart plotter 2-5
- radar 6-6
- Overlay range link 3-11, 6-22
- Overlay soft control 3-5, 3-6, 3-10
- Overlays
- advanced weather 3-8
- advanced weather data 3-8
- animation 3-10
- depth shading 3-5
- marine zone 3-9
- radar 3-11
- satellite photo 3-10
- tidal current 3-14
- tidal information 3-12
- weather data 3-7
- weather radar 3-6
- P**
- Panel dimmer 1-5
- Photo soft control 3-10
- Picture advance speed 7-12
- Points
- attribute defaults 4-5
- avoidance circle 4-9
- deleting, all 4-7
- deleting, at points list 4-7
- deleting, on screen 4-7
- depth at time of entry 4-9
- editing 4-8
- finding location from Points menu 4-10
- finding on chart 4-10
- going to, cursor position 4-13
- going to, on-screen point 4-12
- going to, point on points list 4-15
- groups 4-10
- hiding/showing globally 4-11
- icon 4-9
- information about 4-4
- introduction 4-1
- moving, at points list 4-6
- moving, on-screen point 4-6
- name change 4-8
- placing 4-2
- points list 4-3
- showing 4-11
- stopping following 4-16
- water temperature at time of entry 4-9
- XTE restart 4-16, 5-12
- Points list
- deleting points 4-7
- editing points 4-8
- finding point on chart 4-10
- moving a point 4-6
- placing point from 4-3
- point to follow 4-16
- POINTS/ROUTE key 4-2
- Pop-up menus (context-sensitive menus) 1-14
- Position format 13-13
- Power switch 1-5
- Proximity AIS target alarm 12-2
- Proximity alarm 2-14
- Q**
- Quality of data 2-12
- R**
- Racon 6-28
- Radar buoy 2-12
- Radar overlay 3-11
- RANGE key
- chart plotter 2-4
- fish finder 7-10
- Range measurement
- chart plotter 2-8
- radar 6-8
- Range rings 6-8

INDEX

- Raster soft control2-1
- RotoKey
 - customizing 13-2, 13-6
 - description 1-13
 - operation 1-13
 - set selection 13-5
- Route log5-15
- Routes
 - active route on radar 6-21
 - auto zoom at arrival at point 5-15
 - canceling navigation on from radar 6-20
 - creating new 5-2
 - deleting 5-8
 - deleting points from 5-3
 - extending 5-4
 - finding on chart 5-7
 - following, direction reversal 5-12
 - following, on-screen route 5-9
 - following, route selected from route list.. 5-10
 - following, stopping 5-13
 - hiding on chart plotter 5-9
 - information 5-7
 - inserting points 5-3
 - joining 5-5
 - passage plan 5-16
 - points, skipping 5-13
 - points, switching mode 5-14
 - renaming 5-8
 - routes list 5-6
 - showing active route on radar 6-21
 - showing on chart plotter 5-9
 - splitting 5-4
 - waypoint arrival notification 5-16
 - XTE value on route 5-15
- Routes list
 - displaying 5-6
 - selecting a route 5-10
- Ruler soft control2-8
- S**
- SART6-27
- Sat Photo soft control3-10
- Satellite photo overlay3-10
- SAVE/MOB key
 - MOB function 1-21
 - point saving at current position 4-2
- SD cards
 - care of 1-7
 - formatting 1-7
 - inserting 1-7
 - removing 1-7
 - saving data to 8-1
- Sensor icons 1-12
- Shadow sector 6-26
- SHIP/3D button 2-5, 6-12
- Shipping facilities 2-12
- Sidelobe echoes 6-26
- Sirius radio 11-15
- Small craft services2-12
- Speed alarm2-14
- Speed through water offset13-16
- SST (Sea Surface Temperature)
 - alarm2-14
 - color scale 11-4
 - description 11-6
 - offset 13-16
- Stand-by6-1
- Status bar 1-12
- STC (fish finder) 13-20
- Steering display 10-3
- Storm cell cast 11-8
- Storm tracks 11-7
- Stretch soft control 6-19
- Surface features 11-6
- Surface pressure (weather) 11-6
- Sweep fade 6-20
- System Configurationxiii
- System-Calibration menu 13-16
- System-DFF1/BBDS1/DFF1-UHD, -DFF3/FCV Menu 13-18
- System-ETR-30N menu 13-20
- System-ETR-6/10N menu 13-19
- System-General menu 13-15
- System-Radar menu 13-17
- T**
- Target echo (fish finder) 13-20
- Tidal current information overlay 3-14
- Tidal information overlay 3-12
- Tide Graph soft control 3-13
- Tide Icons soft control 3-12
- Time zone 13-13
- TLL output 13-13
- Track
 - clearing 2-24
 - clearing active 2-22
 - color 2-20
 - erasing saved 2-23
 - information 2-24
 - on/off 2-18
 - replaying saved 2-23
 - saving active 2-22
 - thickness 2-19
- Track history display
 - AIS 12-4
 - ARPA 6-34
- Traffic routes 2-12
- Transmission power (fish finder) 13-18
- Transmit rate 7-24
- Transmitting radar 6-1
- Trip alarm 2-14
- Tropical statement 11-13
- Troubleshooting
 - chart plotter 14-4
 - fish finder 14-4
 - general 14-3
 - radar 14-3
- True motion reset6-7

- True wind display 10-6
- Tuning, manual 13-17
- Tx sector blanking 13-17
- U**
- Units of measurement 13-14
- Unknown object..... 2-12
- V**
- Vector chart
 - bottom features 2-12
 - buoy names..... 2-10
 - buoys and beacons 2-12
 - cautionary areas..... 2-12
 - chart color palette..... 2-10
 - chart data coverage 2-12
 - chart information 2-10
 - customizing 2-10
 - database 2-10
 - depth contours 2-11
 - depth contours and currents 2-12
 - depth soundings..... 2-11
 - display mode 2-12
 - fishing facilities 2-12
 - fog signals 2-12
 - Geographic names..... 2-11
 - geographic names..... 2-11
 - harbour facilities 2-12
 - information areas 2-12
 - land features 2-12
 - light description 2-10
 - light sectors 2-10
 - lights 2-12
 - obstruction depths..... 2-11
 - obstructions..... 2-12
 - quality of data..... 2-12
 - radar buoy 2-12
 - route bearings 2-11
 - seabed 2-11
 - selecting 2-1
 - shipping facilities 2-12
 - small craft services..... 2-12
 - symbols 2-10
 - traffic routes 2-11, 2-12
 - unknown object 2-12
- Vector soft control 2-1
- View angle..... 13-13
- Virtual image (radar) 6-25
- VRM
 - erasing on radar 6-9
 - fish finder..... 7-14
 - radar 6-8
- W**
- Watchman 6-16
- Water temperature graph 7-21
- Waves forecast 11-5
- Weather
 - buoys..... 11-11
 - city forecasts 11-10
 - icons overview..... 11-2
 - lightning 11-9
 - marine observations..... 11-11
 - marine warning..... 11-13
 - marine zone forecast..... 11-12
 - overlay color transparency 11-4
 - pressure 11-6
 - SST color range 11-4
 - SST color scale 11-4
 - SST description..... 11-6
 - storm cell cast 11-8
 - storm tracks..... 11-7
 - surface features 11-6
 - tropical statement..... 11-13
 - waves forecast 11-5
 - weather menu 11-3
 - weather source..... 11-4
 - wind forecast 11-5
- Weather data overlay 3-7
- Weather radar 11-4
- Weather radar overlay..... 3-6
- Weather soft control 3-6
- White marker 7-17
- Wind
 - damping time..... 13-16
 - direction offset..... 13-16
 - speed calibration 13-16
- Wind and weather display 10-5
- Wind forecast 11-5
- Wx Data soft control..... 3-7
- Wx Radar soft control..... 3-6
- X**
- XTE alarm 2-13
- Z**
- Zero line 7-27
- Zoom display selector icon (fish finder)..... 7-4
- Zoom range..... 7-23
- Zoom reference lines 7-22

FURUNO Worldwide Warranty for Pleasure Boats (Except North America)

This warranty is valid for products manufactured by Furuno Electric Co. (hereafter FURUNO) and installed on a pleasure boat. Any web based purchases that are imported into other countries by anyone other than a FURUNO certified dealer may not comply with local standards. FURUNO strongly recommends against importing these products from international websites as the imported product may not work correctly and may interfere with other electronic devices. The imported product may also be in breach of the local laws and mandated technical requirements. Products imported into other countries as described previously shall not be eligible for local warranty service.

For products purchased outside of your country please contact the national distributor of Furuno products in the country where purchased.

This warranty is in addition to the customer's statutory legal rights.

1. Terms and Conditions of Warranty

FURUNO guarantees that each new FURUNO product is the result of quality materials and workmanship. The warranty is valid for a period of 2 years (24 months) from the date of the invoice, or the date of commissioning of the product by the installing certified dealer.

2. FURUNO Standard Warranty

The FURUNO standard warranty covers spare parts and labour costs associated with a warranty claim, provided that the product is returned to a FURUNO national distributor by prepaid carrier.

The FURUNO standard warranty includes:

- Repair at a FURUNO national distributor
- All spare parts for the repair
- Cost for economical shipment to customer

3. FURUNO Onboard Warranty

If the product was installed/commissioned and registered by a certified FURUNO dealer, the customer has the right to the onboard warranty.

The FURUNO onboard warranty includes

- Free shipping of the necessary parts
- Labour: Normal working hours only
- Travel time: Up to a maximum of two (2) hours
- Travel distance: Up to a maximum of one hundred and sixty (160) KM by car for the complete journey

4. Warranty Registration

For the Standard Warranty - presentation of product with serial number (8 digits serial number, 1234-5678) is sufficient. Otherwise, the invoice with serial number, name and stamp of the dealer and date of purchase is shown.

For the Onboard Warranty your FURUNO certified dealer will take care of all registrations.

5. Warranty Claims

For the Standard Warranty - simply send the defective product together with the invoice to a FURUNO national distributor. For the Onboard Warranty – contact a FURUNO national distributor or a certified dealer. Give the product's serial number and describe the problem as accurately as possible.

Warranty repairs carried out by companies/persons other than a FURUNO national distributor or a certified dealer is not covered by this warranty.

6. Warranty Limitations

When a claim is made, FURUNO has a right to choose whether to repair the product or replace it.

The FURUNO warranty is only valid if the product was correctly installed and used. Therefore, it is necessary for the customer to comply with the instructions in the handbook. Problems which result from not complying with the instruction manual are not covered by the warranty.

FURUNO is not liable for any damage caused to the vessel by using a FURUNO product.

The following are excluded from this warranty:

- a. Second-hand product
- b. Underwater unit such as transducer and hull unit
- c. Routine maintenance, alignment and calibration services.
- d. Replacement of consumable parts such as fuses, lamps, recording papers, drive belts, cables, protective covers and batteries.
- e. Magnetron and MIC with more than 1000 transmitting hours or older than 12 months, whichever comes first.
- f. Costs associated with the replacement of a transducer (e.g. Crane, docking or diver etc.).
- g. Sea trial, test and evaluation or other demonstrations.
- h. Products repaired or altered by anyone other than the FURUNO national distributor or an authorized dealer.
- i. Products on which the serial number is altered, defaced or removed.
- j. Problems resulting from an accident, negligence, misuse, improper installation, vandalism or water penetration.
- k. Damage resulting from a force majeure or other natural catastrophe or calamity.
- l. Damage from shipping or transit.
- m. Software updates, except when deemed necessary and warrantable by FURUNO.
- n. Overtime, extra labour outside of normal hours such as weekend/holiday, and travel costs above the 160 KM allowance
- o. Operator familiarization and orientation.

FURUNO Electric Company, March 1, 2011

FURUNO Warranty for North America

FURUNO U.S.A., Limited Warranty provides a twenty-four (24) months LABOR and twenty-four (24) months PARTS warranty on products from the date of installation or purchase by the original owner. Products or components that are represented as being waterproof are guaranteed to be waterproof only for, and within the limits, of the warranty period stated above. The warranty start date may not exceed eighteen (18) months from the original date of purchase by dealer from Furuno USA and applies to new equipment installed and operated in accordance with Furuno USA's published instructions.

Magnetrons and Microwave devices will be warranted for a period of 12 months from date of original equipment installation.

Furuno U.S.A., Inc. warrants each new product to be of sound material and workmanship and through its authorized dealer will exchange any parts proven to be defective in material or workmanship under normal use at no charge for a period of 24 months from the date of installation or purchase.

Furuno U.S.A., Inc., through an authorized Furuno dealer will provide labor at no cost to replace defective parts, exclusive of routine maintenance or normal adjustments, for a period of 24 months from installation date provided the work is done by Furuno U.S.A., Inc. or an AUTHORIZED Furuno dealer during normal shop hours and within a radius of 50 miles of the shop location.

A suitable proof of purchase showing date of purchase, or installation certification must be available to Furuno U.S.A., Inc., or its authorized dealer at the time of request for warranty service.

This warranty is valid for installation of products manufactured by Furuno Electric Co. (hereafter FURUNO). Any purchases from brick and mortar or web-based resellers that are imported into other countries by anyone other than a FURUNO certified dealer, agent or subsidiary may not comply with local standards. FURUNO strongly recommends against importing these products from international websites or other resellers, as the imported product may not work correctly and may interfere with other electronic devices. The imported product may also be in breach of the local laws and mandated technical requirements. Products imported into other countries, as described previously, shall not be eligible for local warranty service.

For products purchased outside of your country please contact the national distributor of Furuno products in the country where purchased.

WARRANTY REGISTRATION AND INFORMATION

To register your product for warranty, as well as see the complete warranty guidelines and limitations, please visit www.furunousa.com and click on "Support". In order to expedite repairs, warranty service on Furuno equipment is provided through its authorized dealer network. If this is not possible or practical, please contact Furuno U.S.A., Inc. to arrange warranty service.

FURUNO U.S.A., INC.
Attention: Service Coordinator
4400 N.W. Pacific Rim Boulevard
Camas, WA 98607-9408
Telephone: (360) 834-9300
FAX: (360) 834-9400

Furuno U.S.A., Inc. is proud to supply you with the highest quality in Marine Electronics. We know you had several choices when making your selection of equipment, and from everyone at Furuno we thank you. Furuno takes great pride in customer service.

Declaration of Conformity

[MFD8/MFD12]

Bulgarian (BG)	<p>С настоящото Furuno Electric Co., Ltd. декларира, че гореспоменат тип радиосъоръжение е в съответствие с Директива 2014/53/ЕС. Цялостният текст на ЕС декларацията за съответствие може да се намери на следния интернет адрес:</p>
Spanish (ES)	<p>Por la presente, Furuno Electric Co., Ltd. declara que el tipo de equipo radioeléctrico arriba mencionado es conforme con la Directiva 2014/53/UE. El texto completo de la declaración UE de conformidad está disponible en la dirección Internet siguiente:</p>
Czech (CS)	<p>Tímto Furuno Electric Co., Ltd. prohlašuje, že výše zmíněné typ rádiového zařízení je v souladu se směrnicí 2014/53/EU. Úplné znění EU prohlášení o shodě je k dispozici na této internetové adrese:</p>
Danish (DA)	<p>Hermed erklærer Furuno Electric Co., Ltd., at ovennævnte radioudstyr er i overensstemmelse med direktiv 2014/53/EU. EU-overensstemmelseserklæringens fulde tekst kan findes på følgende internetadresse:</p>
German (DE)	<p>Hiermit erkläre die Furuno Electric Co., Ltd., dass der oben genannte Funkanlagentyp der Richtlinie 2014/53/EU entspricht. Der vollständige Text der EU-Konformitätserklärung ist unter der folgenden Internetadresse verfügbar:</p>
Estonian (ET)	<p>Käesolevaga deklareerib Furuno Electric Co., Ltd., et ülalmainitud raadioseadme tüüp vastab direktiivi 2014/53/EL nõuetele. ELi vastavusdeklaratsiooni täielik tekst on kättesaadav järgmisel internetiaadressil:</p>
Greek (EL)	<p>Με την παρούσα η Furuno Electric Co., Ltd., δηλώνει ότι ο προαναφερθέντας ραδιοεξοπλισμός πληροί την οδηγία 2014/53/ΕΕ. Το πλήρες κείμενο της δήλωσης συμμόρφωσης ΕΕ διατίθεται στην ακόλουθη ιστοσελίδα στο διαδίκτυο:</p>
English (EN)	<p>Hereby, Furuno Electric Co., Ltd. declares that the above-mentioned radio equipment type is in compliance with Directive 2014/53/EU. The full text of the EU declaration of conformity is available at the following internet address:</p>
French (FR)	<p>Le soussigné, Furuno Electric Co., Ltd., déclare que l'équipement radioélectrique du type mentionné ci-dessus est conforme à la directive 2014/53/UE. Le texte complet de la déclaration UE de conformité est disponible à l'adresse internet suivante:</p>
Croatian (HR)	<p>Furuno Electric Co., Ltd. ovime izjavljuje da je gore rečeno radijska oprema tipa u skladu s Direktivom 2014/53/EU. Cjeloviti tekst EU izjave o sukladnosti dostupan je na sljedećoj internetskoj adresi:</p>
Italian (IT)	<p>Il fabbricante, Furuno Electric Co., Ltd., dichiara che il tipo di apparecchiatura radio menzionato sopra è conforme alla direttiva 2014/53/UE. Il testo completo della dichiarazione di conformità UE è disponibile al seguente indirizzo Internet:</p>
Latvian (LV)	<p>Ar šo Furuno Electric Co., Ltd. deklarē, ka augstāk minēts radioiekārta atbilst Direktīvai 2014/53/ES. Pilns ES atbilstības deklarācijas teksts ir pieejams šādā interneta vietnē:</p>

Lithuanian (LT)	Aš, Furuno Electric Co., Ltd., patvirtinu, kad pirmiau minėta radijo įrenginių tipas atitinka Direktyvą 2014/53/ES. Visas ES atitikties deklaracijos tekstas prieinamas šiuo interneto adresu:
Hungarian (HU)	Furuno Electric Co., Ltd. igazolja, hogy fent említett típusú rádióberendezés megfelel a 2014/53/EU irányelvnek. Az EU-megfelelőségi nyilatkozat teljes szövege elérhető a következő internetes címen:
Maltese (MT)	B'dan, Furuno Electric Co., Ltd., niddikjara li msemmija hawn fuq-tip ta' tagħmir tar-radju huwa konformi mad-Direttiva 2014/53/UE. It-test kollu tad-dikjarazzjoni ta' konformità tal-UE huwa disponibbli f'dan l-indirizz tal-Internet li ġej:
Dutch (NL)	Hierbij verklaar ik, Furuno Electric Co., Ltd., dat het hierboven genoemde type radioapparaat conform is met Richtlijn 2014/53/EU. De volledige tekst van de EU-conformiteitsverklaring kan worden geraadpleegd op het volgende internetadres:
Polish (PL)	Furuno Electric Co., Ltd. niniejszym oświadcza, że wyżej wymieniony typ urządzenia radiowego jest zgodny z dyrektywą 2014/53/UE. Pełny tekst deklaracji zgodności UE jest dostępny pod następującym adresem internetowym:
Portuguese (PT)	O(a) abaixo assinado(a) Furuno Electric Co., Ltd. declara que o mencionado acima tipo de equipamento de rádio está em conformidade com a Diretiva 2014/53/UE. O texto integral da declaração de conformidade está disponível no seguinte endereço de Internet:
Romanian (RO)	Prin prezenta, Furuno Electric Co., Ltd. declară că menționat mai sus tipul de echipamente radio este în conformitate cu Directiva 2014/53/UE. Textul integral al declarației UE de conformitate este disponibil la următoarea adresă internet:
Slovak (SK)	Furuno Electric Co., Ltd. týmto vyhlasuje, že vyššie spomínané rádiové zariadenie typu je v súlade so smernicou 2014/53/EÚ. Úplné EÚ vyhlásenie o zhode je k dispozícii na tejto internetovej adrese:
Slovenian (SL)	Furuno Electric Co., Ltd. potrjuje, da je zgoraj omenjeno tip radijske opreme skladen z Direktivo 2014/53/EU. Celotno besedilo izjave EU o skladnosti je na voljo na naslednjem spletnem naslovu:
Finnish (FI)	Furuno Electric Co., Ltd. vakuuttaa, että yllä mainittu radiolaitetyyppi on direktiivin 2014/53/EU mukainen. EU-vaatimusten mukaisuusvakuutuksen täysimittainen teksti on saatavilla seuraavassa internetosoitteessa:
Swedish (SV)	Härmed försäkrar Furuno Electric Co., Ltd. att ovan nämnda typ av radioutrustning överensstämmer med direktiv 2014/53/EU. Den fullständiga texten till EU-försäkran om överensstämmelse finns på följande webbadress:

Online Resource

http://www.furuno.com/en/support/red_doc