

FURUNO

OPERATOR'S MANUAL

CLASS B AIS TRANSPONDER

Model

FA-70

ECF

(Elemental Chlorine Free)

The paper used in this manual
is elemental chlorine free.

FURUNO ELECTRIC CO., LTD.

9-52 Ashihara-cho,
Nishinomiya, 662-8580, JAPAN

• FURUNO Authorized Distributor/Dealer

All rights reserved. Printed in Japan

Pub. No. OME-45150-B

(TEHI) FA-70

A : FEB. 2020

B : JUL. 16, 2021



0 0 0 1 9 7 4 0 2 1 1

IMPORTANT NOTICES

General

- This manual has been authored with simplified grammar, to meet the needs of international users.
- The operator of this equipment must read and follow the instructions in this manual. Wrong operation or maintenance can void the warranty or cause injury.
- Do not copy any part of this manual without written permission from FURUNO.
- If this manual is lost or worn, contact your dealer about replacement.
- The contents of this manual and the equipment specifications can change without notice.
- The example screens (or illustrations) shown in this manual can be different from the screens you see on your display. The screens you see depend on your system configuration and equipment settings.
- Save this manual for future reference.
- Any modification of the equipment (including software) by persons not authorized by FURUNO will void the warranty.
- The following concern acts as our importer in Europe, as defined in DECISION No 768/2008/EC.
 - Name: FURUNO EUROPE B.V.
 - Address: Ridderhaven 19B, 2984 BT Ridderkerk, The Netherlands
- The following concern acts as our importer in UK, as defined in SI 2016/1025 as amended SI 2019/470.
 - Name: FURUNO (UK) LTD.
 - Address: West Building Penner Road Havant Hampshire PO9 1QY, U.K.
- Microsoft and Windows are registered trademarks or trademarks of the Microsoft Corporation of the USA and other countries.
- All brand, product names, trademarks, registered trademarks, and service marks belong to their respective holders.

How to discard this product

Discard this product according to local regulations for the disposal of industrial waste. For disposal in the USA, see the homepage of the Electronics Industries Alliance (<http://www.eiae.org/>) for the correct method of disposal.

How to discard a used battery

Some FURUNO products have a battery(ies). To see if your product has a battery, see the chapter on Maintenance. If a battery is used, tape the + and - terminals of the battery before disposal to prevent fire, heat generation caused by short circuit.

In the European Union

The crossed-out trash can symbol indicates that all types of batteries must not be discarded in standard trash, or at a trash site. Take the used batteries to a battery collection site according to your national legislation and the Batteries Directive 2006/66/EU.

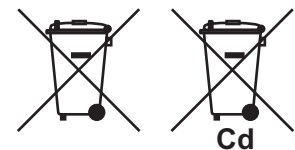

In the USA

The Mobius loop symbol (three chasing arrows) indicates that Ni-Cd and lead-acid rechargeable batteries must be recycled. Take the used batteries to a battery collection site according to local laws.

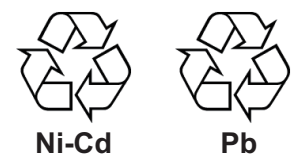



In the other countries

There are no international standards for the battery recycle symbol. The number of symbols can increase when the other countries make their own recycle symbols in the future.









SAFETY INSTRUCTIONS



The operator and installer must read the applicable safety instructions before attempting to install or operate the equipment.

 WARNING	Indicates a potentially hazardous situation which, if not avoided, could result in death or serious injury.
 CAUTION	Indicates a potentially hazardous situation which, if not avoided, could result in minor or moderate injury.

 Warning, Caution	 Prohibitive Action	 Mandatory Action
--	--	--

Safety Instructions for the Operator

 WARNING
 Do not open the equipment. This equipment uses high voltage that can cause electrical shock. Only qualified personnel can work inside the equipment.
 Do not disassemble or modify the equipment. Fire, electrical shock or serious injury can occur. If the equipment does not work properly, contact your dealer.
 Turn off the power immediately if water leaks into the equipment or smoke or fire is coming from the equipment. Fire or electrical shock can result.
 Use the correct fuse. Use of a wrong fuse can cause fire or serious damage to the equipment.
 Do not operate the equipment with wet hands. Electrical shock can result.

 WARNING
 Make sure no rain or water splash leaks into the equipment. Fire or electrical shock can result if water leaks into the equipment.
 Do not place liquid-filled containers on or near the equipment. Fire or electrical shock can result if a liquid spills into the equipment.

 CAUTION
 Do not disconnect the power cable while the system is powered. Damage to the equipment can result.

Safety Instructions for the Installer

 **WARNING**



ELECTRICAL SHOCK HAZARD
Do not open the equipment.

Only qualified personnel can work inside the equipment.



Turn off the power at the switchboard before beginning the installation.

Fire or electrical shock can result if the power is left on.



Do not install the equipment where it may get wet from rain or water splash.

Water in the equipment can result in fire, electrical shock or damage to the equipment.



Be sure that the power supply is compatible with the voltage rating of the equipment.

Connection of an incorrect power supply can cause fire or damage the equipment.

 **CAUTION**



Observe the following compass safe distances to prevent interference to a magnetic compass:

	Type	Standard compass	Steering compass
Antenna Unit	GPA-017S	0.3 m	0.3 m
	GPA-017	0.3 m	0.3 m
	GPA-C01	0.3 m	0.3 m
AIS Transponder	FA-70	0.3 m	0.3 m
Power Supply Unit	PR-240	0.9 m	0.6 m
	PR-241	0.85 m	0.55 m

Radiation Hazard

 **WARNING**



Do not approach the antenna closer than 0.2 m when it is transmitting.

The antenna emits radio waves which can be harmful to the human body, particularly the eyes.

Radiation level	Distance
100 W/m ²	N/A
10 W/m ²	N/A
2 W/m ²	0.2 m

TABLE OF CONTENTS

FOREWORD	v
SYSTEM CONFIGURATION	vii
1. INSTALLATION	1-1
1.1 Equipment List	1-1
1.2 Included Items and Local Supplies	1-4
1.3 Required Tools and Materials	1-5
1.4 AIS Transponder FA-70	1-5
1.5 GPS Antenna	1-6
1.6 VHF Antenna (option)	1-7
1.7 AC-DC Power Supply (option)	1-8
1.8 Wiring	1-9
2. SHIP INFORMATION INPUT	2-1
2.1 How to Install the Driver	2-1
2.2 How to Install the AIS Setting Tool	2-2
2.3 How to Start and Quit the AIS Setting Tool	2-3
2.4 Overview of the AIS Setting Tool	2-4
2.5 Initial Setup	2-5
3. SETTINGS AND STATUS	3-1
3.1 IO setup (input/output port)	3-1
3.2 Own Vessel Data Screen	3-2
3.3 Alert Status	3-3
3.4 IO Monitor	3-4
4. MAINTENANCE	4-1
4.1 Maintenance	4-1
4.2 Replacement of Fuse	4-1
4.3 Troubleshooting	4-2
4.4 Diagnostics	4-3
APPENDIX 1 MENU TREE	AP-1
APPENDIX 2 ALERT LISTS	AP-4
APPENDIX 3 NMEA2000/0183 INPUT/OUTPUT DATA	AP-5
APPENDIX 4 RADIO REGULATORY INFORMATION	AP-7
SPECIFICATIONS	SP-1
PACKING LISTS	A-1
OUTLINE DRAWING	D-1
INTERCONNECTION DIAGRAM	S-1
Declaration of Conformity	

FOREWORD

A Word to the Owner of the FA-70

FURUNO Electric Company thanks you for purchasing the FURUNO FA-70 Class B AIS Transponder. We are confident you will discover why the FURUNO name has become synonymous with quality and reliability.

Since 1948, FURUNO Electric Company has enjoyed an enviable reputation for quality and reliability throughout the world. This dedication to excellence is furthered by our extensive global network of agents and dealers.

Your equipment is designed and constructed to meet the rigorous demands of the marine environment. However, no machine can perform its intended function unless properly operated and maintained. Please carefully read and follow the operation and maintenance procedures in this manual.

We would appreciate feedback from you, the end-user, about whether we are achieving our goal.

Thank you for considering and purchasing FURUNO equipment.

Features

The FA-70 is a Class B AIS (Automatic Identification System) capable of exchanging navigation and ship data between own ship and other ships or coastal stations.

The main features are:

- Fully meets the following regulations: IEC 62287-1, IEC 62287-2
- Switchable communication system; SOTDMA and CSTDMA
- Capable of initial setting from the TZTL12F/15F/TZT2BB (software version: 07.01 or later) or TZT9F/12F/16F/19F
- Built in VHF splitter
The VHF splitter enables the AIS transponder and VHF transceiver to share a single VHF antenna.
- Capable of easy updating to the latest software
- Meets NMEA2000 requirements
- Static data
 - MMSI (Maritime Mobile Service Identity), ship's name, call sign
 - Types of ship and cargo
 - Location of position-fixing antenna on the ship
- Dynamic data
 - Ship's position with accuracy indication and integrity status
 - Universal Time Coordinated (UTC)
 - Course over ground (COG)
 - Speed over ground (SOG)

Usage notes

MMSI

Before commencing installation, ensure you have obtained a MMSI number for your vessel.

In the United States of America, it is a violation of the rules of the Federal Communications Commission to input an MMSI that has not been properly assigned to the end user or to otherwise input any inaccurate data in this device. The MMSI and Static Data must be entered only by a FURUNO dealer or other appropriately qualified installer of marine communications equipment on board vessels.

For other locations, check your local regulations for details regarding MMSI and static data input.

Note: You can enter the MMSI only once. If it becomes necessary to change the MMSI, contact your dealer.

VHF splitter in the FA-70

- AIS transmission and reception can not be done during the VHF radio transmission.
- A “pop” noise may be generated from the VHF radio during the AIS transmission, however this is not abnormal as it occurs during AIS transmission.
- Supported VHF radio: 155 MHz to 164 MHz, Power < 25 W

Software used in this product

This product includes software to be licensed under the Apache and BSD.

Program No.

0550263-01.** (** denotes minor modifications.)

SYSTEM CONFIGURATION

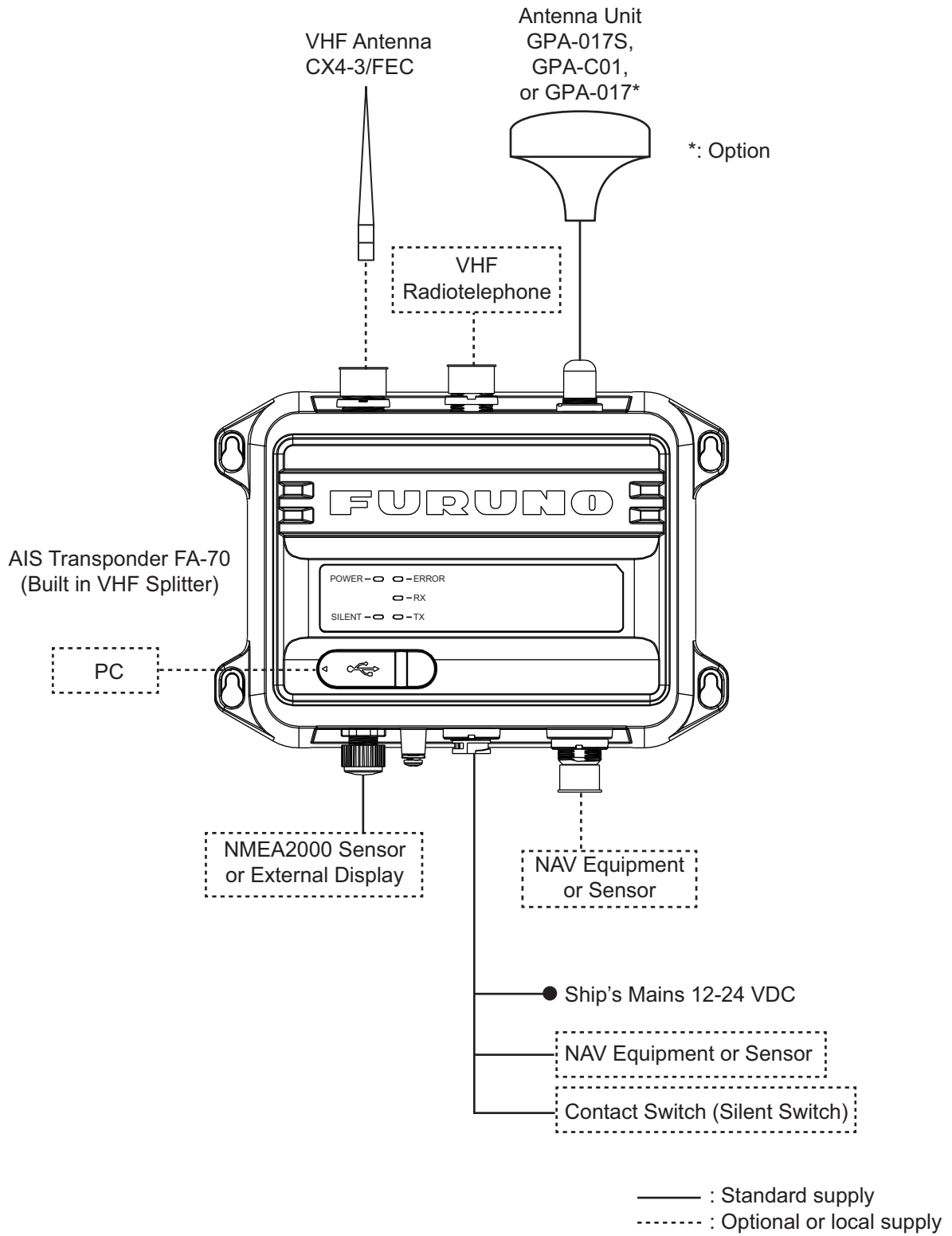

This page is intentionally left blank.

1. INSTALLATION

1.1 Equipment List

Standard supply

Name	Type	Qty	Remarks
AIS Transponder	FA-70	1	Built in VHF Splitter
Antenna Unit	GPA-017S	Select one	GPS Antenna
	GPA-C01		
Installation Materials	61110000000101	1	PWR/NMEA1/SILENT Cable
	NPD-MM1MF1000G02M	1	NMEA2000 Cable
	PA4×25	4	Tapping Screws
Spare Parts	250VAC 5A	2	Tube Fuses
Accessories	FA70/60/40 SW *CD*	1	AIS Setting Tool (CD-ROM for PC software*)

*: The CD-ROM for PC software and USB driver is supplied as standard. The folder structure of the CD-ROM is shown in the table below.

Folder		File	Remarks
AIS_Setting_Tool	DotNetFX40	dotNetFx40_Full_x86_x64.exe	
	vcredist_x86	vcredist_x86.exe	
	Windows Installer4_5	Windows6.0-KB958655-v2-x64.MSU, etc.	
	–	AIS_Setting_Tool_Installer.msi	
	–	setup.exe	Install file of AIS setting tool
USBDriver ForWindows7	–	cdc.cat	Install file of USB driver (required to connect the FA-70 with USB CDC)
	–	FURUNO_AIS.inf	

PC requirements

OS	Microsoft® Windows® 7 (32 bit / 64 bit), Microsoft® Windows® 10 (64 bit)
CPU	Min. 1 GHz
Main memory	32 bit: min. 1 GB, 64 bit: min. 2 GB
Resolution	1280 × 720 or better
Language pack	English
USB communication	USB CDC (Communication Device Class) USB2.0 / Type A-Micro B cable

1. INSTALLATION

Optional supply

Name	Type	Code No.	Remarks	
Antenna Unit	GPA-017	-	GPS antenna	
	GPA-017S	-		
	GPA-C01	-		
AC/DC Power Supply Unit	PR-240	-		
	PR-241	-		
Ferrite Core	OP86-11	001-594-450	For PR-241	
Cable Assembly	TNC-PS/PS-3D-L15M-R	001-173-110-10	For GPA-017S, TNC-TNC (15 m)	
	FRU-NMEA-PMMFF-010	001-533-060	Max. 6 m	
	FRU-NMEA-PMMFF-020	001-533-070		
	FRU-NMEA-PMMFF-060	001-533-080		
	FRU-NMEA-PFF-010	001-507-010		
	FRU-NMEA-PFF-020	001-507-030		
	FRU-NMEA-PFF-060	001-507-040		
	MJ-A6SPF0003-020C	000-154-029-10		Max. 15 m
	MJ-A6SPF0003-050C	000-154-054-10		
	MJ-A6SPF0003-100C	000-168-924-10		
	MJ-A6SPF0003-150C	000-159-643-10		
	Antenna Cable Assembly	CP20-02700 (30M)	004-381-160	For GPA-017S (30 m), 8D-FB-CV*30M*
		CP20-02710 (50M)	004-381-170	For GPA-017S (50 m), 8D-FB-CV*50M*
CP20-02720 (40M)		001-207-990	For GPA-017S (40 m), 8D-FB-CV*40M*	
Mast Mounting Kit	CP20-01111	004-365-780	For GPS antenna	
Antenna	CX4-3/FEC	001-474-340		

Name	Type	Code No.	Remarks
Antenna Fixing Bracket	N173F/FEC	001-474-350	For CX4-3/FEC (φ49-90)
	N174F/FEC	001-494-890	For CX4-3/FEC (φ30-61)
Right Angle Mounting Base	NO.13-QA330	001-111-910-10	For GPS antenna
L-Angle Mounting Base	NO.13-QA310	001-111-900-10	For GPS antenna
Handrail Mounting Base	NO.13-RC5160	001-111-920-10	For GPS antenna
Micro T-Connector	FRU-MM1MF1MF1001	001-507-050	
Termination Resistor (Micro)	FRU-MM1000000001	001-507-070	
	FRU-MF000000001	001-507-060	
In-Line Terminator	FRU-0505-FF-IS	001-077-830-10	

1.2 Included Items and Local Supplies

AIS Transponder

- AIS Transponder (1 pcs)

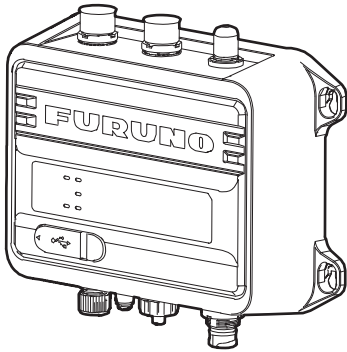

- Tapping screws (4 pcs)

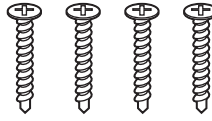

- Documents (1 set)

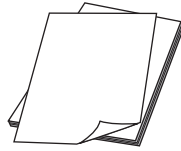

- AIS Setting Tool (1 pcs)

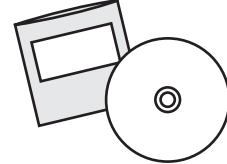

Antenna Unit

- Antenna Unit (1 pcs)

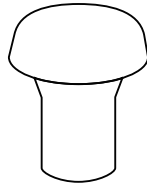

GPA-017S

or

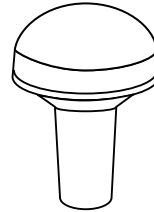

GPA-C01

Cable assembly

- PWR/NMEA1/SILENT cable (1 pcs): 2 m

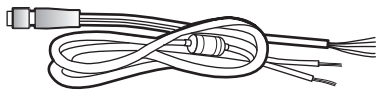

- NMEA2000 cable (1 pcs): 2 m

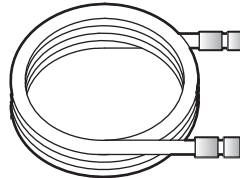

- Spare tube fuse (5A, 2 pcs)



Local supplies

- 5D-2V cable

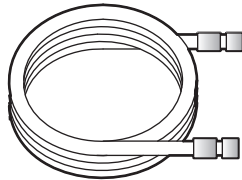

- USB (standard-A - micro-B) cable: max. 2 m

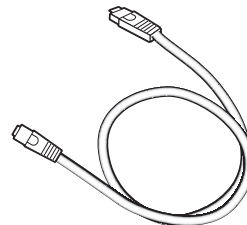

1.3 Required Tools and Materials

The following tools should be prepared in advance for this installation.

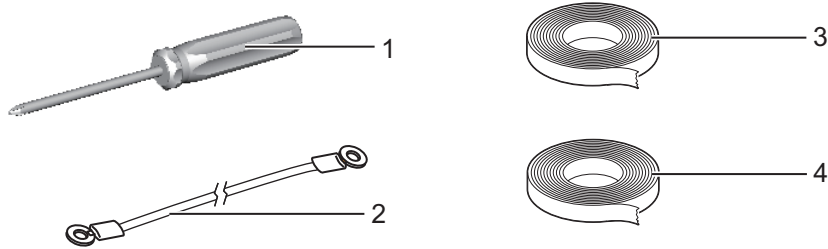

No.	Name	Remarks
1	Phillips-head screwdriver	#3, for mounting the chassis
2	Ground wire	IV-1.25sq
3	Self-vulcanizing tape	For waterproofing the junction of connectors
4	Vinyl tape*	

*: For cosmetic purposes, black color vinyl tape (cable color) is recommended.

1.4 AIS Transponder FA-70

Mounting considerations, mounting

The FA-70 can be mounted on a desktop or on a bulkhead. When selecting a mounting location, keep in mind the following points:

- Keep the unit out of direct sunlight.
- The temperature and humidity should be moderate and stable.
- Locate the unit away from exhaust pipes and vents.
- The mounting location should be well ventilated.
- Mount the unit where shock and vibration are minimal.
- Keep the unit away from electromagnetic field-generating equipment such as motors and generators.
- A magnetic compass will be affected if the FA-70 is placed too close to it. Observe the compass safe distances noted in the safety instructions to prevent disturbance to the magnetic compass.

Fix the unit to the mounting location with four tapping screws (supplied).

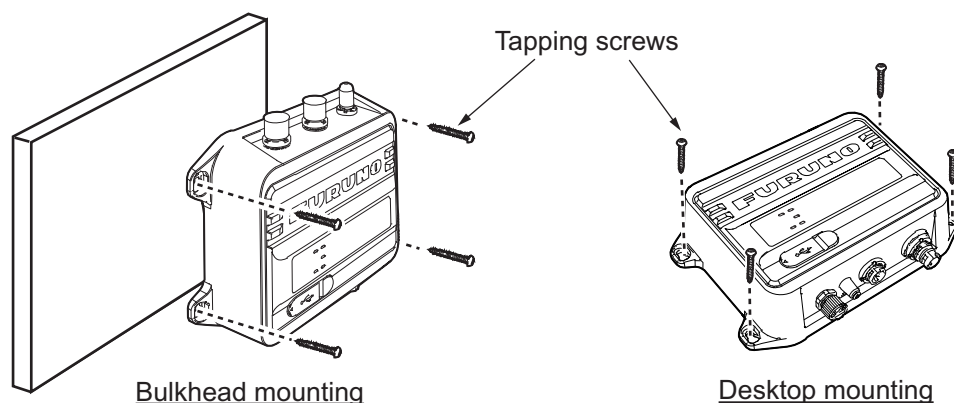

1.5 GPS Antenna

 <h3 style="margin: 0;">CAUTION</h3> <p style="margin: 5px 0;">Do not connect the GPS antenna connector to ground.</p> <p style="margin: 5px 0;">Short circuit can result.</p>
--

Install the GPS antenna unit referring to the outline drawing at the back of this manual. When selecting a mounting location for the antenna, keep the following in mind:

- Select a location out of the radar and inmarsat beams. The radar beam will obstruct or prevent reception of the GPS satellite signal.
- There should be no interfering object within the line-of-sight to the satellites. Objects within line-of-sight to a satellite, for example, a mast, may block reception or prolong acquisition time.
- Mount the antenna unit as high as possible to keep it free of interfering objects and water spray, which can interrupt reception of GPS satellite signal if the water freezes.
- The location should be well away from a VHF antenna. A VHF antenna emits harmonic waves, which can interfere with the GPS receiver.

How to extend the antenna cable

Use the cable type RG-10/UJ (shipyard supply) to extend the antenna cable.

Note: The length of this cable should be less than 20 m to prevent signal loss. The coax. coupling cable assy.(type: NJ-TP-3DXV-1, code no. 000-123-809), coaxial connector (N-P-8DFB; supplied), vulcanizing tape and vinyl tape are required. Fabricate both ends of the cable as shown in the figure below.

How to attach the connector N-P-8DSFA for cable 8D-FB-CV

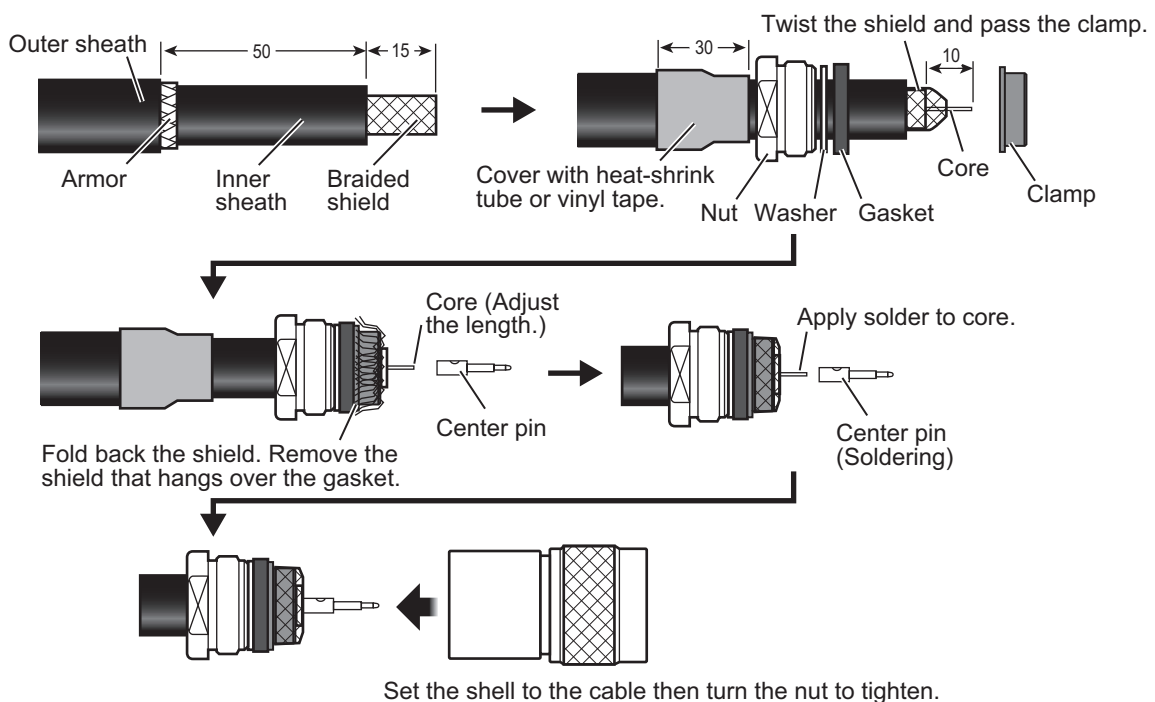

1.6 VHF Antenna (option)

Location

The location of the VHF antenna should be carefully considered. It may be necessary to relocate the VHF radiotelephone antenna to minimize interference effects. To minimize interference effects, the following guidelines apply:

- Select a location out of the radar and inmarsat beams. Those beams will obstruct or prevent reception of the AIS signal.
- The VHF antenna should be placed in an elevated position that is as free as possible with a minimum of 0.5 meters in the horizontal direction from constructions made of conductive materials. The antenna should not be installed close to any large vertical obstruction. The objective for the VHF antenna is to see the horizon freely through 360 degrees.
- There should not be more than one antenna on the same plane. The VHF antenna should be mounted directly above or below the ship's primary VHF radiotelephone antenna, with no horizontal separation and with a minimum of 2.8 meters vertical separation. If it is located on the same plane as other antennas, the distance apart should be at least 10 meters.

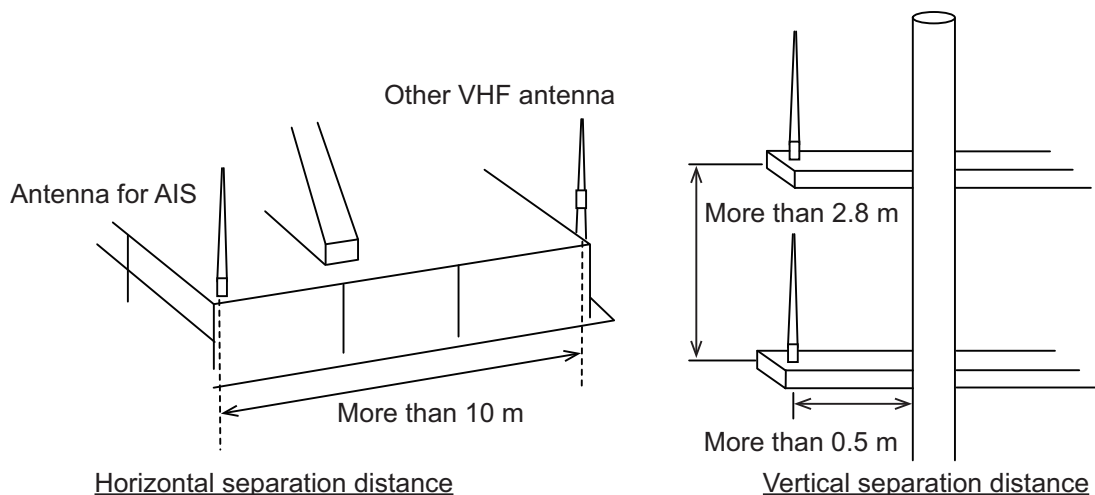

Cabling

- The cable should be kept as short as possible to minimize signal attenuation. Coaxial cables equal to or better than 5D-2V are recommended.
- All outdoor-installed connectors on coaxial cables should be fitted with preventive isolation such as vulcanizing tape to protect against water penetration into the antenna cable. Also, apply marine sealant at the antenna base to prevent water intrusion from the screw part of the antenna base.
- Coaxial cables should be installed in separate signal cable channels/tubes and at least 10 cm away from power supply cables. Crossing of cables should be done at right angles (90 degrees). The minimum bend radius of the coaxial cable should be 5 times the cable's outer diameter.

When coaxial cable 5D-2V (shipyard supply) is used, attach the coaxial plug M-P-5 (shipyard supply) as shown on the next page.

1. INSTALLATION

How to attach the plug M-P-5

Lay the coaxial cable and attach an M-type plug to the cable as follows.

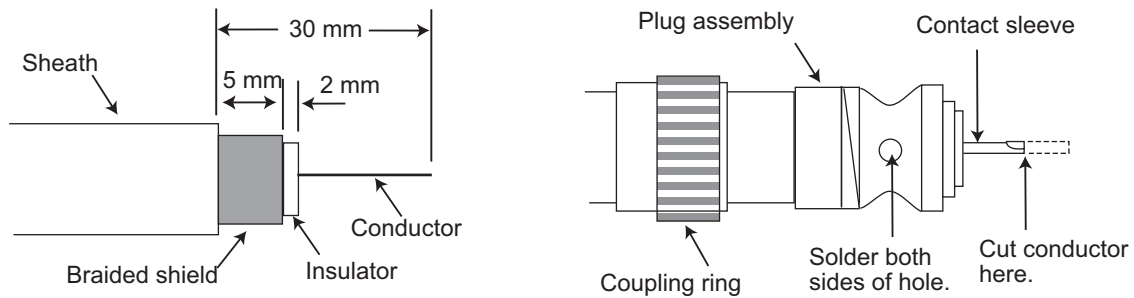

1. Remove the sheath by 30 mm.
2. Bare 23 mm of the center conductor. Trim braided shield by 5 mm and tin.
3. Slide coupling ring onto cable.
4. Screw the plug assembly on the cable.
5. Solder plug assembly to braided shield through solder holes. Solder contact sleeve to conductor.
6. Screw coupling ring into plug assembly.

Waterproofing connector

Wrap connector with vulcanizing tape and then vinyl tape. Bind the tape end with a cable-tie.

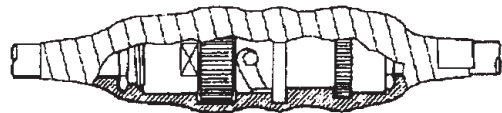

1.7 AC-DC Power Supply (option)

When selecting a mounting location for the unit, keep the following in mind:

- Keep the unit away from areas subject to water splash.
- Locate the unit away from exhaust pipes and vents.
- The mounting location should be well ventilated.
- Mount the unit where shock and vibration are minimal.
- A magnetic compass will be affected if the unit is placed too close to it. Observe the compass safe distances noted in the safety instructions to prevent disturbance to the magnetic compass.

Fix the unit with four self-tapping screws (4×16) to a desktop or the deck. It is not necessary to open the cover.

1.8 Wiring

Connect the equipment, referring to the figure below and the interconnection diagram at the back of this manual.

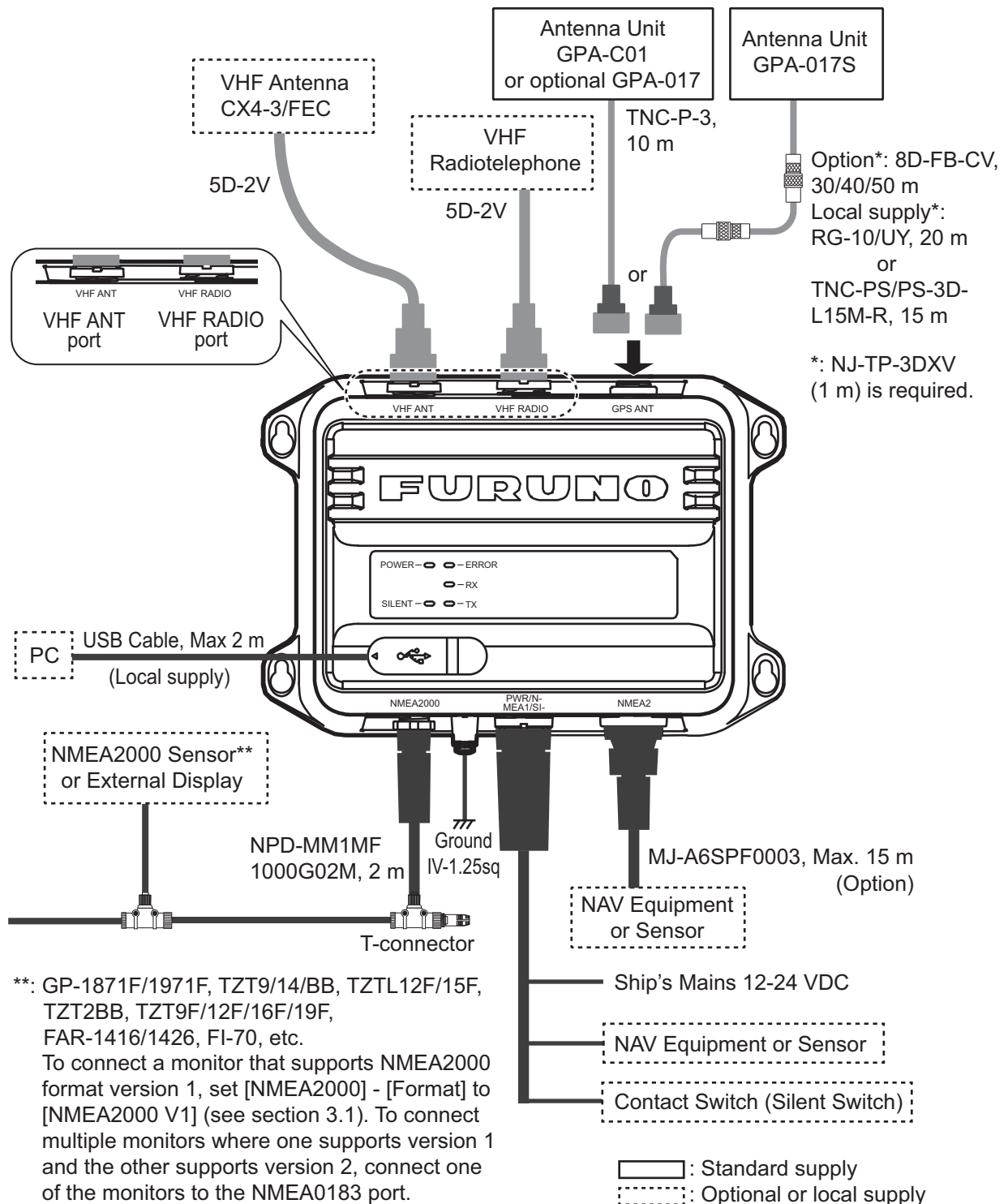

Note 1: The FA-70 does not have a power switch. Install an external device (power switchboard, etc.) from which to control its power.

Note 2: Connect the VHF antenna to the “VHF ANT” port, and the VHF radiotelephone to the “VHF RADIO” port. If the VHF radiotelephone is connected to the “VHF ANT” port, the VHF radiotelephone and the FA-70 may be damaged.

1. INSTALLATION

How to waterproof the connector for VHF antenna and VHF radiotelephone

Wrap the connector for VHF antenna and VHF radiotelephone with vulcanizing tape.

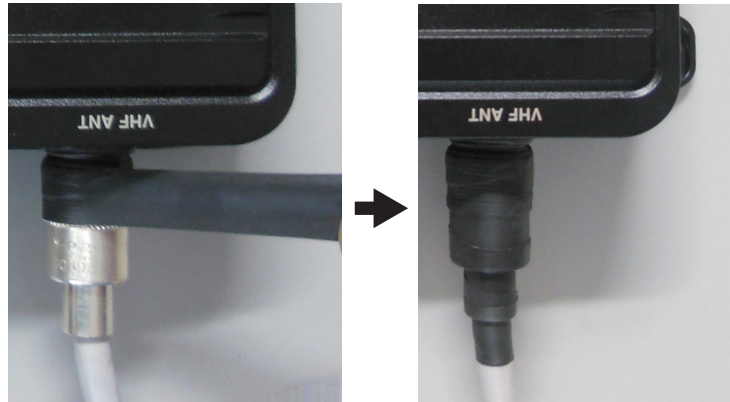

Connection with the PC and NavNet TZtouch2/3

The FA-70 may be connected to a PC or TZTL12F/TZTL15F/TZT2BB/TZT9F/TZT12F/TZT16F/TZT19F. See the figure below for connection examples.

 CAUTION
PC connected by USB is only powered by a battery.
Short circuit can result if the PC is connected to ground.

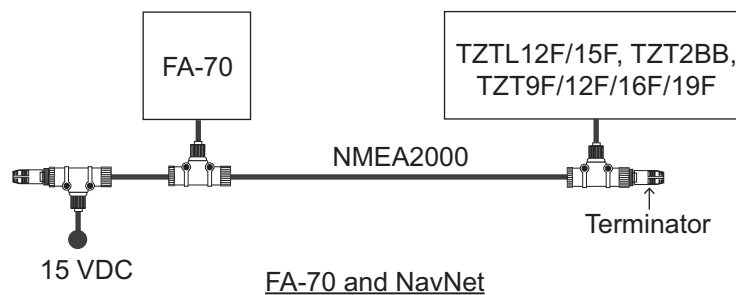
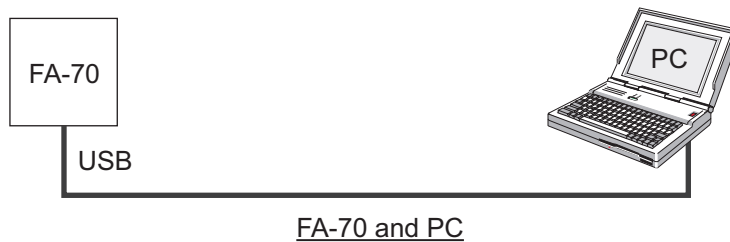

2. SHIP INFORMATION INPUT

You must set the ship static information after the installation of the equipment. The FA-70 is set up from the PC or external display (TZTL12F*/15F*/TZT2BB* or TZT9F/12F/16F/19F). When setting from the PC, install the USB driver and PC software (see sections 2.1 and 2.2). When setting from the external display, open the home screen, and then select [Settings] - [Initial Setup] - [NETWORK SENSOR SETUP] - [FA-70] in order to display the menus.

*: The software version 07.01 or later is required.

2.1 How to Install the Driver

The CD-ROM for PC software and USB driver is supplied as standard.

Note 1: Install the driver with administration rights.

Note 2: In the case of Microsoft® Windows® 10, the “Driver” file is already installed. If you need to re-install this file, install this file in [Device Manager].

Note 3: “Microsoft.NET Framework 4(×86 or ×64)” is installed at the time of the AIS Setting Tool installation.

The following instructions are for Windows® 7.

1. Turn the FA-70 on.
2. Connect the USB cable between the FA-70 and the PC.
3. Set the supplied CD-ROM in the CD drive.
4. Click the [Start] button and then click [Control Panel].
5. Click [Device Manager].
6. Enter the administrator password and then click [Yes].
7. Double-click [Other devices] – [VIRTUAL COM PORT] in order.
8. Click the [General] tab and then click [Update Driver...].
9. Click [Browse my computer for driver software].
10. Select the [USBDriverForWindows7] folder in the CD-ROM.
11. Click [Install this driver software anyway] to install the driver. After the installation, [FURUNO AIS (COMxx)] is displayed in [Ports (COM & LPT)] of [Device Manager].
12. Remove the CD-ROM from the CD drive.

2.2 How to Install the AIS Setting Tool

Note: Install the AIS setting tool with administration rights.

1. Set the supplied CD-ROM in the CD drive.
2. Click [AIS_Setting_Tool].
3. Click [setup.exe].

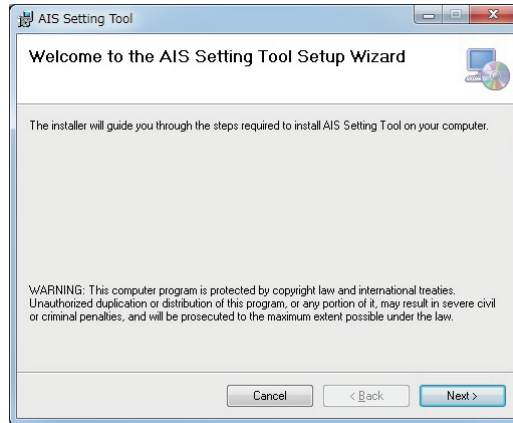

4. Click [Next].

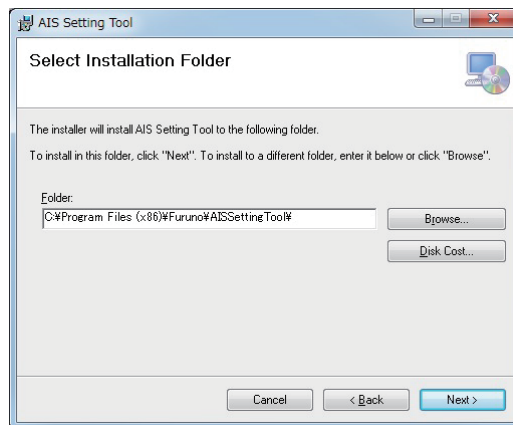

5. Click [Next]. To change the installation folder, click [Browse] and select the folder before clicking [Next].

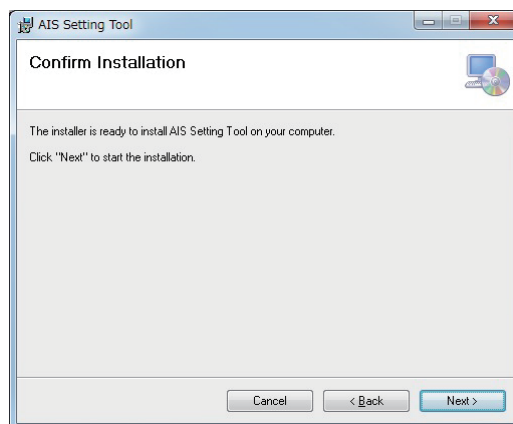

- Click [Next] to start the installation. When the installation is completed, the dialog box shown below appears.

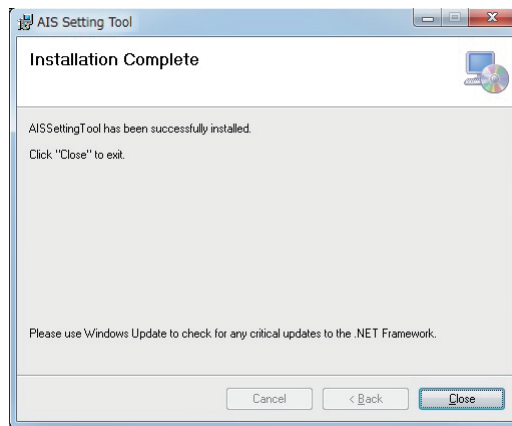

- Click [Close] to finish. The shortcut icon for [AIS_Setting_Tool.exe] is created on your desktop.
- Remove the CD-ROM from the CD drive.

2.3 How to Start and Quit the AIS Setting Tool

- Double-click the shortcut icon for [AIS_Setting_Tool.exe].

Select the COM port to connect.

Connect/Disconnect

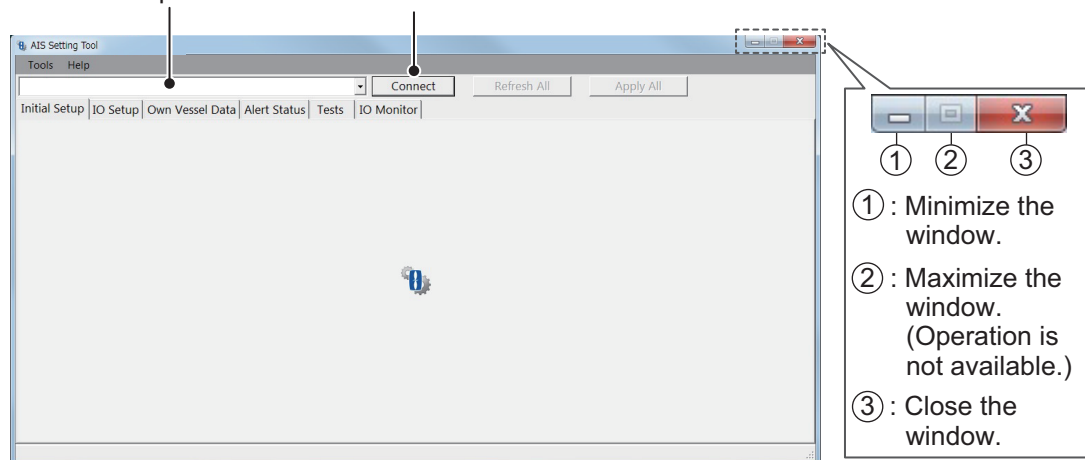

- Click the down-arrow button at the top left of the screen, and then select the COM port to connect.
- Click [Connect].
- To quit the software, click [Disconnect], and then click the close button (x) at the upper right-hand corner of the screen.

2.4 Overview of the AIS Setting Tool

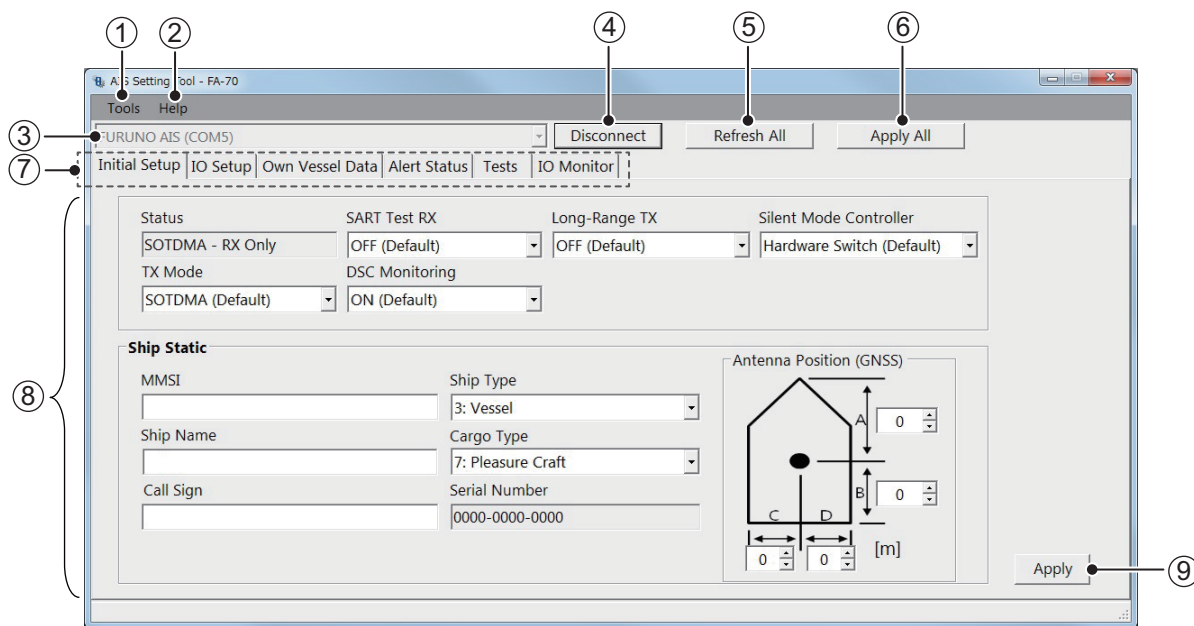

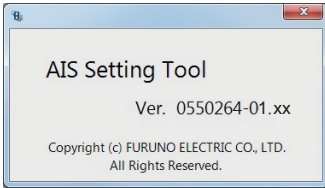
No.	Name	Description
1	[Tools]	<ul style="list-style-type: none"> [Disconnect]: Disconnects from the FA-70. [Screenshot...]: Takes a screenshot.
2	[Help]	<ul style="list-style-type: none"> [Usage Considerations]: Shows the precautions for use. [About]: Shows the program version number. <div style="text-align: center;">  <p>xx denotes minor modifications.</p> </div>
3	Port selection	Select the COM port to connect.
4	[Connect]/[Disconnect]	<ul style="list-style-type: none"> [Connect]: Connects to the FA-70. [Disconnect]: Disconnects from the FA-70.
5	[Refresh All]	Obtains the latest data from the FA-70, and then updates all settings of all menu tabs.
6	[Apply All]	Saves all settings in all tab pages, and then transmits the data to the FA-70.
7	Menu tab	Opens each menu.
8	Setting/Display area	Shows the setting values, menu options, status, test results, and other according to the selected menu.
9	[Apply]	Saves all settings in the current tab page, and then transmits the data to the FA-70.

2.5 Initial Setup

You can set up the TX/RX mode, own ship's static information (MMSI, ship's name, call sign, antenna position and type of ship), and silent mode from the [Initial Setup] menu. You must set the ship static information.

In the United States of America, it is a violation of the rules of the Federal Communications Commission to input an MMSI that has not been properly assigned to the end user or to otherwise input any inaccurate data in this device. The MMSI and Static Data must be entered only by a FURUNO dealer or other appropriately qualified installer of marine communications equipment on board vessels.

For other locations, check your local regulations for details regarding MMSI and static data input.

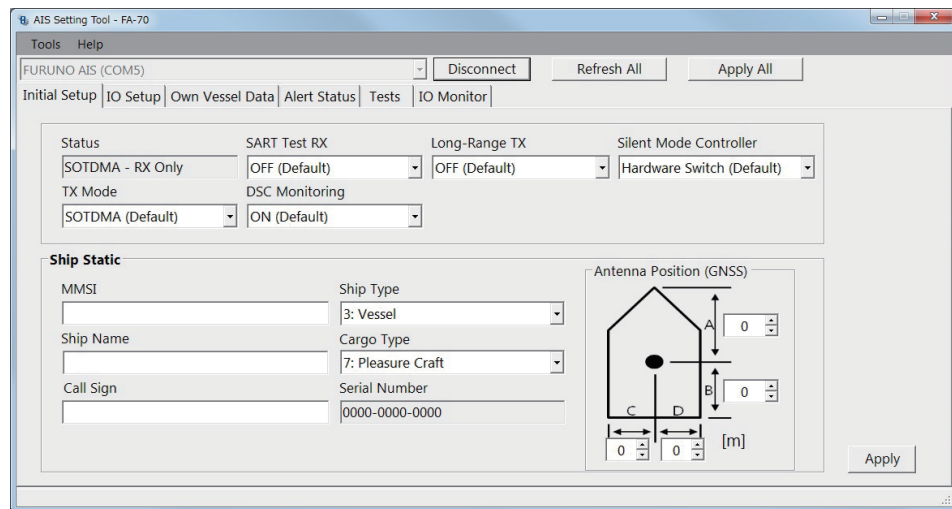

[Status] ([AIS Status] on the external display), [Serial Number]: Display only.

[Initial Setup] menu for PC

Most of the menu items are the same between the PC and external display. For details, see "MENU TREE" on page AP-1.

Menu item	Description
[AIS Status] (for the external display)	Shows the status for transmission and reception of AIS.
[Status] (for the PC)	
[TX Mode]	Select the transmission mode from [SOTDMA] or [CSTDMA]. [SOTDMA]: Self-organized time division multiple access (This is the default mode setting.) [CSTDMA]: Carrier sense time division multiple access (Transmission interval for CSTDMA is longer than SOTDMA.) When changing the transmission mode, the confirmation message appears. Click [Yes], and then click [Apply] to restart the FA-70.
[SART Test RX]	Select whether to receive an AIS SART test message.
[DSC Monitoring]	Select whether to receive a DSC message.
[Long-Range TX]	Select whether to transmit a long-range AIS broadcast message. This menu is displayed when [TX Mode] is set to [SOTDMA].
[Silent Mode Controller]	Select the silent mode controller from hardware or software.

2. SHIP INFORMATION INPUT

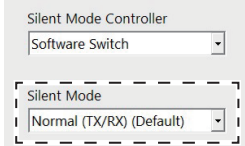
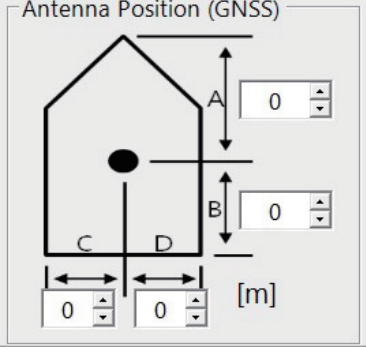
Menu item	Description
[Silent Mode]	<p>When selecting [Software Switch] in the [Silent Mode Controller] menu, the [Silent Mode] menu (see right-hand figure) appears on the screen.</p> <p>Select the FA-70 function from [Normal (TX/RX)] or [RX Only].</p> <p>[Normal (TX/RX)]: The FA-70 transmits and receives.</p> <p>[RX Only]: The FA-70 receives only.</p> 
[Ship Static]	
[MMSI]	<p>Enter the ship's MMSI (nine digits). The available MMSI numbers are displayed at the bottom of the screen.</p> <p>Note 1: When the ship's MMSI has already been set, the number is only displayed.</p> <p>Note 2: You can enter the MMSI only once. If it becomes necessary to change the MMSI, contact your dealer.</p> <p>Note 3: When the MMSI is not set, you can not transmit the data.</p>
[Ship Name]	Enter the ship's name, using up to 20 alphanumeric characters.
[Call Sign]	Enter the call sign, using seven alphanumeric characters.
[Ship Type]	Select the ship type.
[Cargo Type]	Select the cargo type. Available options depend on the setting of [Ship Type].
[Serial Number]	Shows the serial number for the equipment.
[Antenna Position]	<p>Set the antenna position referring to the following figure.</p>  <p>A: Distance from bow to GPS antenna position (setting range: 0 to 511 m)</p> <p>B: Distance from stern to GPS antenna position (setting range: 0 to 511 m)</p> <p>C: Distance from port to GPS antenna position (setting range: 0 to 63 m)</p> <p>D: Distance from starboard to GPS antenna position (setting range: 0 to 63 m)</p>

For the PC, click [Apply] or [Apply All] to confirm the settings.

Note: If you entered the MMSI, the following message appears when clicking [Apply] or [Apply All].

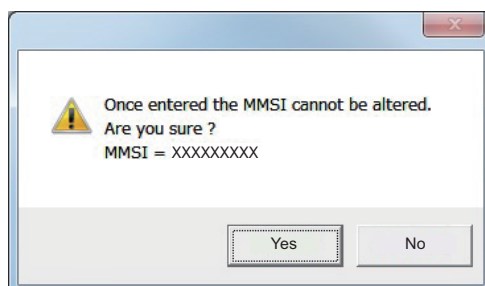

Click [Yes] to save the settings, [No] to cancel the settings.

For the external display, the same message appears when entering the MMSI. Select [Yes] to save the settings, [No] to cancel the settings. When selecting [Yes], the same message appears again. Select [Yes] again.

3. SETTINGS AND STATUS

3.1 IO setup (input/output port)

You can change the input/output settings from the [IO Setup] menu.

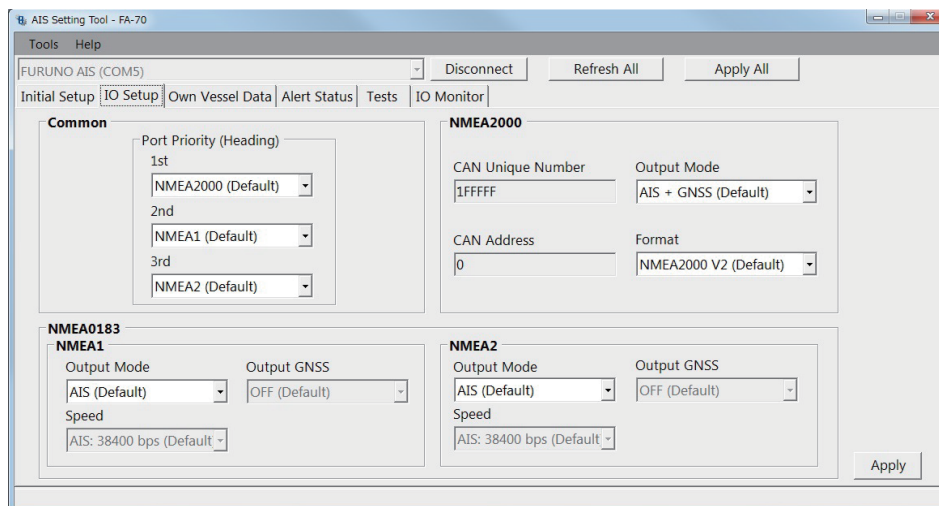

[CAN Unique Number], [CAN Address]: Display only.

[IO Setup] menu for PC

Menu item	Description
[Common]	
[Port Priority (Heading)] [1st], [2nd], [3rd]	Set the input port priority for heading data.
[NMEA2000]	
[CAN Unique Number]	Shows the CAN unique number.
[CAN Address]	Shows the CAN address.
[Output Mode]	Select the output mode among [OFF], [AIS], [GNSS], or [AIS + GNSS]. [OFF]: Does not output AIS or GNSS data. [AIS]: Outputs AIS data. [GNSS]: Outputs GNSS data. [AIS + GNSS]: Outputs both AIS and GNSS data.
[Format]	Select the output PGN format version from [NMEA2000 V2] or [NMEA2000 V1].
[NMEA0183]	
[NMEA1 Output Mode], [NMEA2 Output Mode]	Select the output mode among [OFF], [AIS], [GNSS], or [AIS + GNSS].
[NMEA1 Speed], [NMEA2 Speed]	When selecting [OFF] or [GNSS] in the [NMEA1/NMEA2 Output Mode] menu, select the baudrate for NMEA1/NMEA2 from [AIS: 38400 bps] or [Sensor: 4800 bps].

3. SETTINGS AND STATUS

Menu item	Description
[NMEA1 Output GNSS], [NMEA2 Output GNSS]	When selecting [GNSS] or [AIS + GNSS] in the [NMEA1/NMEA2 Output Mode] menu, select the output GNSS sentence for NMEA1/NMEA2 among [OFF], [GGA + VTG (Sentences)], [GLL + VTG (Sentences)] or [RMC (Sentence)]. [OFF]: Does not output GGA, VTG, GLL or RMC sentence. [GGA + VTG (Sentences)]: Outputs GGA and VTG sentences. [GLL + VTG (Sentences)]: Outputs GLL and VTG sentences. [RMC (Sentence)]: Outputs RMC sentence.

For the PC, click [Apply] or [Apply All] to confirm the settings.

3.2 Own Vessel Data Screen

The [Own Vessel Data] screen shows AIS channel, sensor status, and GNSS status.

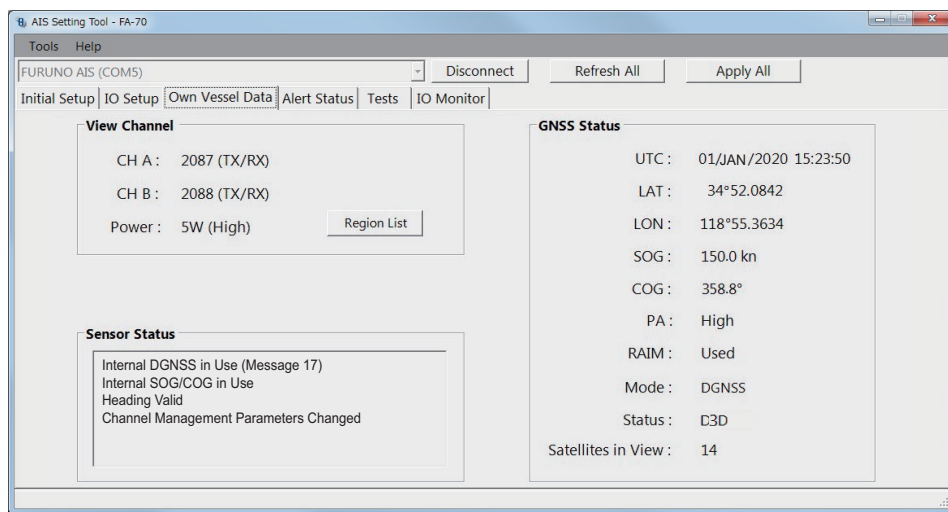

[Own Vessel Data] screen for PC

Menu item	Description
[View Channel]	
[CH A]	Shows the channel number and TX/RX mode for channel A.
[CH B]	Shows the channel number and TX/RX mode for channel B.
[Power]	Shows the transmission power.
[Region List] (for the PC)	Shows the channel management information of local sea areas. To take a screenshot, click [Screenshot] at the bottom right of the screen.
[Sensor Status]	Shows the information about the sensors connected to the FA-70. <ul style="list-style-type: none"> Internal DGNSS in Use: DGNSS currently in use. Internal GNSS in Use: GNSS currently in use. Internal SOG/COG in Use: SOG/COG currently in use. Heading Valid: Heading data is valid. Channel Management Parameters Changed (for the PC): Channel parameters have been changed.

Menu item	Description
[GNSS Status] (for the PC)	Shows the GNSS information. <ul style="list-style-type: none"> • [UTC]: Universal Time Coordinated • [LAT]: Latitude • [LON]: Longitude • [SOG]: Speed over ground • [COG]: Course over ground • [PA]: Positioning accuracy • [RAIM] (Receiver autonomous integrity monitoring): Whether to use RAIM or not. • [Mode]: Positioning mode • [Status]: Positioning status • [Satellites in View]: The number of satellites in view.

3.3 Alert Status

The [Alert Status] screen shows the alerts currently occurred.

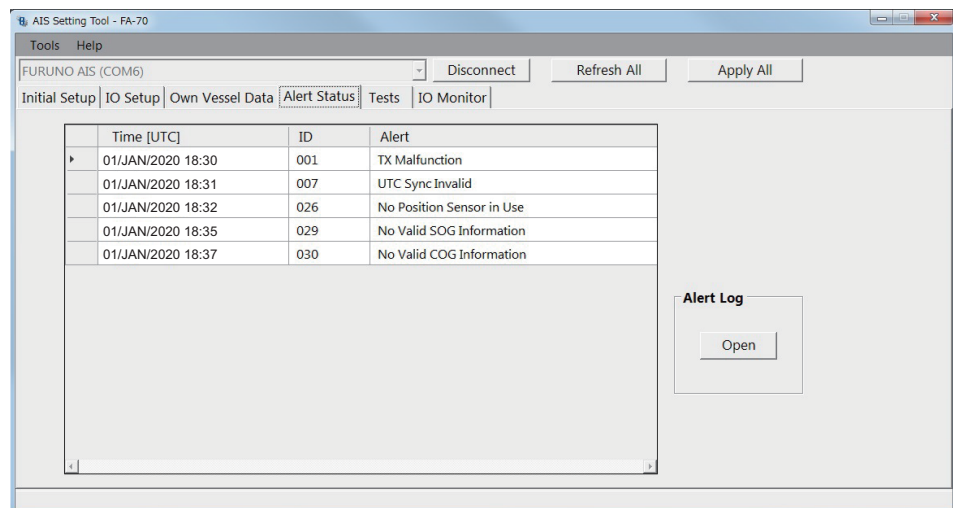

[Alert Status] screen for PC

- [Time [UTC]]: Shows the time and date when the alert occurred.
- [ID]: Shows the alert number.
- [Alert]: Shows the alert message*.

*: For the external display, select the alert ID to display the alert message on the bottom of the screen.

3. SETTINGS AND STATUS

For the PC, click [Open] of [Alert Log] to show the alerts that occurred in the past (max. 20 alerts).

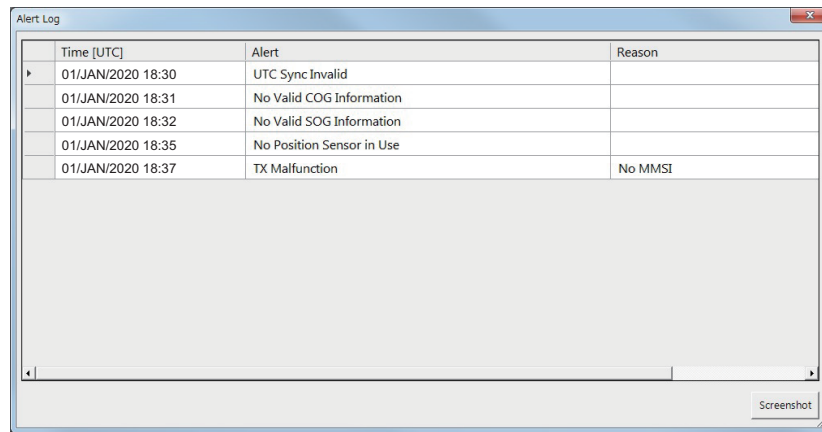

- [Time [UTC]]: Shows the time and date when the alert occurred.
- [Alert]: Shows the alert message.
- [Reason]: Shows the reason why the alert occurred.

Click [Screenshot] to take a screenshot.

For the alert lists, see page AP-4.

3.4 IO Monitor

The data input from each port can be monitored.

Note: This menu appears only on the PC.

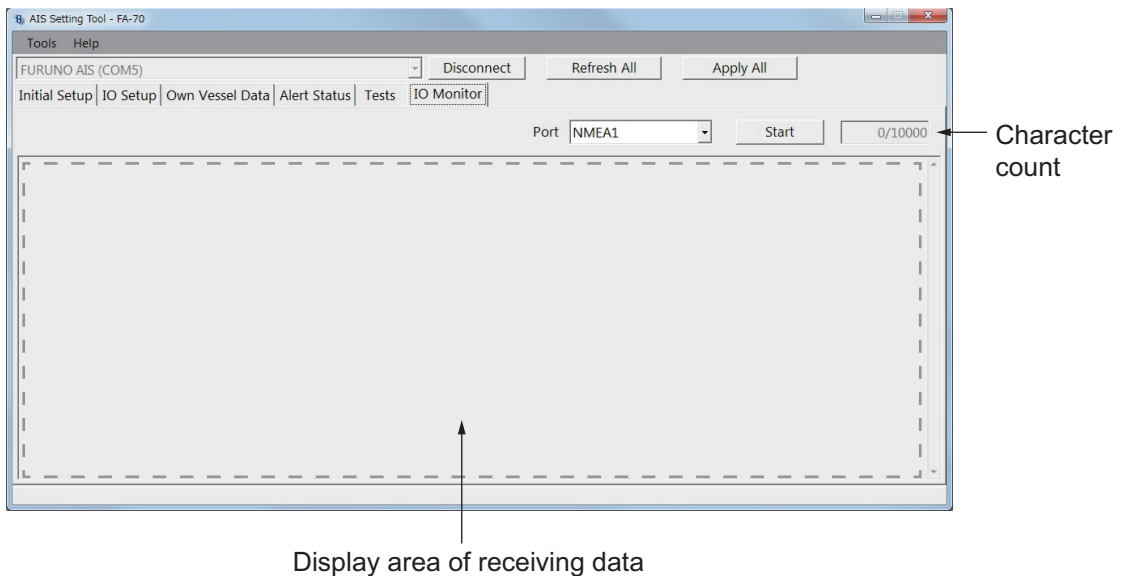

- [Port]: Select the port that displays the received data.
- [Start]: Click to start the receiving data display. The display shows a maximum of 10,000 characters. The [Start] button changes to the [Stop] button.
- [Stop]: Click to stop the receiving data display. The [Stop] button changes to the [Start] button.

4. MAINTENANCE

 **WARNING**

 **ELECTRICAL SHOCK HAZARD**
Do not open the equipment.

Only qualified personnel can work inside the equipment.

NOTICE

Do not apply paint, anti-corrosive sealant or contact spray to coating or plastic parts of the equipment.

Those items contain organic solvents that can damage coating and plastic parts, especially plastic connectors.

4.1 Maintenance

Regular maintenance helps good performance. Check the items listed below monthly to keep your equipment in good working order.

Item	Check point
Wiring	Check that each cable and wire are securely fastened. Refasten if necessary.
Ground	Check grounding for rust. Clean if necessary.
Antenna	Check antenna and its cabling for damage. Replace if necessary.
Cabinet	Dust and dirt should be removed from the cabinet with a soft, dry cloth. Do not use chemical-based cleaners; they can remove paint and markings.

4.2 Replacement of Fuse

 **WARNING**

Use the correct fuse.

Use of a wrong fuse can cause fire or serious damage to the equipment.

The fuse (5A) in the cable protects the equipment from overcurrent and equipment fault. If the unit cannot be powered, that is, the POWER LED does not light, the fuse may have blown. If this happens, turn off the power to the FA-70, and check the fuse. If the fuse has blown, find out the reason before replacing it. If it blows again after replacement, contact your dealer for advice.

Name	Type
Tube Fuse	250VAC 5A

4.3 Troubleshooting

The troubleshooting table below provides typical operating problems and the means to restore normal operation. If you cannot restore normal operation, do not open the cover of the FA-70; there are no user serviceable parts inside the transponder.

Symptom	Remedy
Cannot turn on the power.	<ul style="list-style-type: none"> • Check the cable between the transponder and power for damage. • Check the power supply. • Check the fuse.
Cannot transmit/receive.	<ul style="list-style-type: none"> • Check that the VHF antenna cable is firmly connected. • Check the VHF antenna and its cabling for damage.
The message is sent to a wrong ship.	Confirm the MMSI.
No position data.	<ul style="list-style-type: none"> • Check the GPS antenna. • Check the GPS antenna cable and its connectors.
ERROR LED lights in red.	Contact your dealer.
ERROR LED lights in orange.	<ul style="list-style-type: none"> • Check that the GPS antenna is correctly connected. • Check that the VHF antenna is correctly connected. • Confirm the MMSI.
Cannot start the AIS Setting Tool, or cannot connect the PC to the transponder.	<ul style="list-style-type: none"> • Check the USB cable between the transponder and the PC for damage. • Do the following: <ol style="list-style-type: none"> 1) Quit the AIS Setting Tool. 2) Disconnect the USB cable from the PC, and then connect the cable again. 3) Start the AIS Setting Tool.

AIS Transponder FA-70

The FA-70 has no power switch. Power is fed from the ship's switchboard, and a power switch on the switchboard turns the FA-70 on or off.

The table below shows the function for each LED.

LED	Color	Meaning
POWER	Green	When the power is on, the POWER LED lights in green for CSTDMA mode.
	Blue	When the power is on, the POWER LED lights in blue for SOTDMA mode.
SILENT	Blue	The SILENT LED lights in blue when the silent mode is set to on.
ERROR	Red	The ERROR LED lights in red when equipment error (TX, RX, ROM, or RAM) is found.
	Orange	The ERROR LED lights in orange when the equipment is not installed correctly.
RX	Green	The RX LED lights in green for 50 msec when receiving.
TX	Green	The TX LED lights in green for 200 msec when transmitting.
	Orange	<ul style="list-style-type: none"> • The TX LED blinks in orange when continuous transmission is not possible (TX time out). • The TX LED lights in orange when the MMSI is not set.

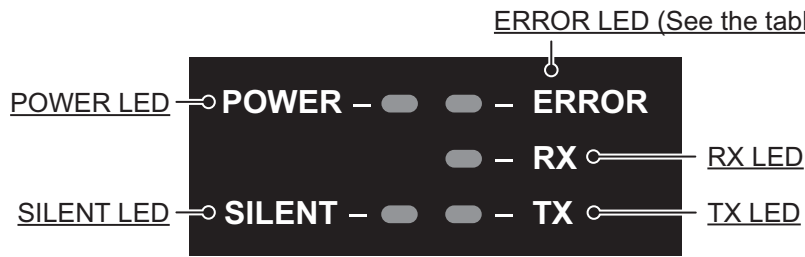

Red	Orange
<ul style="list-style-type: none"> • Memory error • RX1/2 PLL unlock error • TX PLL unlock error • TX power error 	<ul style="list-style-type: none"> • GPS antenna short • Lost position • VSWR error • Temperature error • Power amplifier voltage error • MMSI not registered • Noise level error (CSTDMA mode only)

4.4 Diagnostics

The FA-70 provides diagnostic tests to check the transponder unit for proper operation.

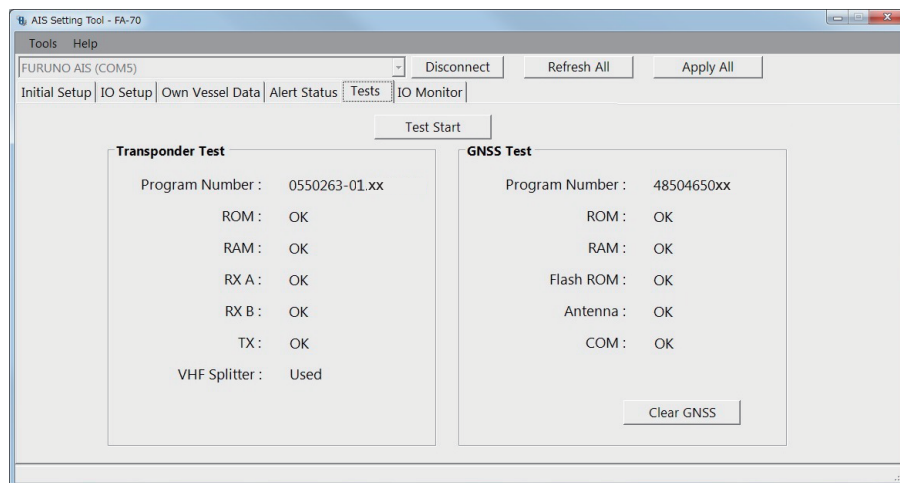

[Tests] screen for PC

Menu item	Description
[Test Start] (for the PC)	Click to start the test.
[Transponder Test]	The program version number appears on the first line. The RAM, ROM, two RX channels (A and B) and TX are checked for proper operation, and the results are displayed as "OK" or "NG" (No Good). For any NG, contact your dealer for advice. When the VHF splitter board is connected, "Used" appears, not connected, "Unused" appears on the last line.
[GNSS Test]	The program version number appears on the first line. The ROM, RAM, Flash ROM, the connection with antenna (including power line) and COM (communication) are checked for proper operation, and the results are displayed as [OK] or [NG] (No Good). For any NG, contact your dealer for advice.
[Clear GNSS] (for the PC)	Click to initialize the internal GNSS core. The confirmation message "Clear GNSS. Are you sure?" appears. Click [Yes] to initialize.

4. MAINTENANCE

This page is intentionally left blank.

APPENDIX 1 MENU TREE

AIS Setting Tool (PC)

Bold italic: Default

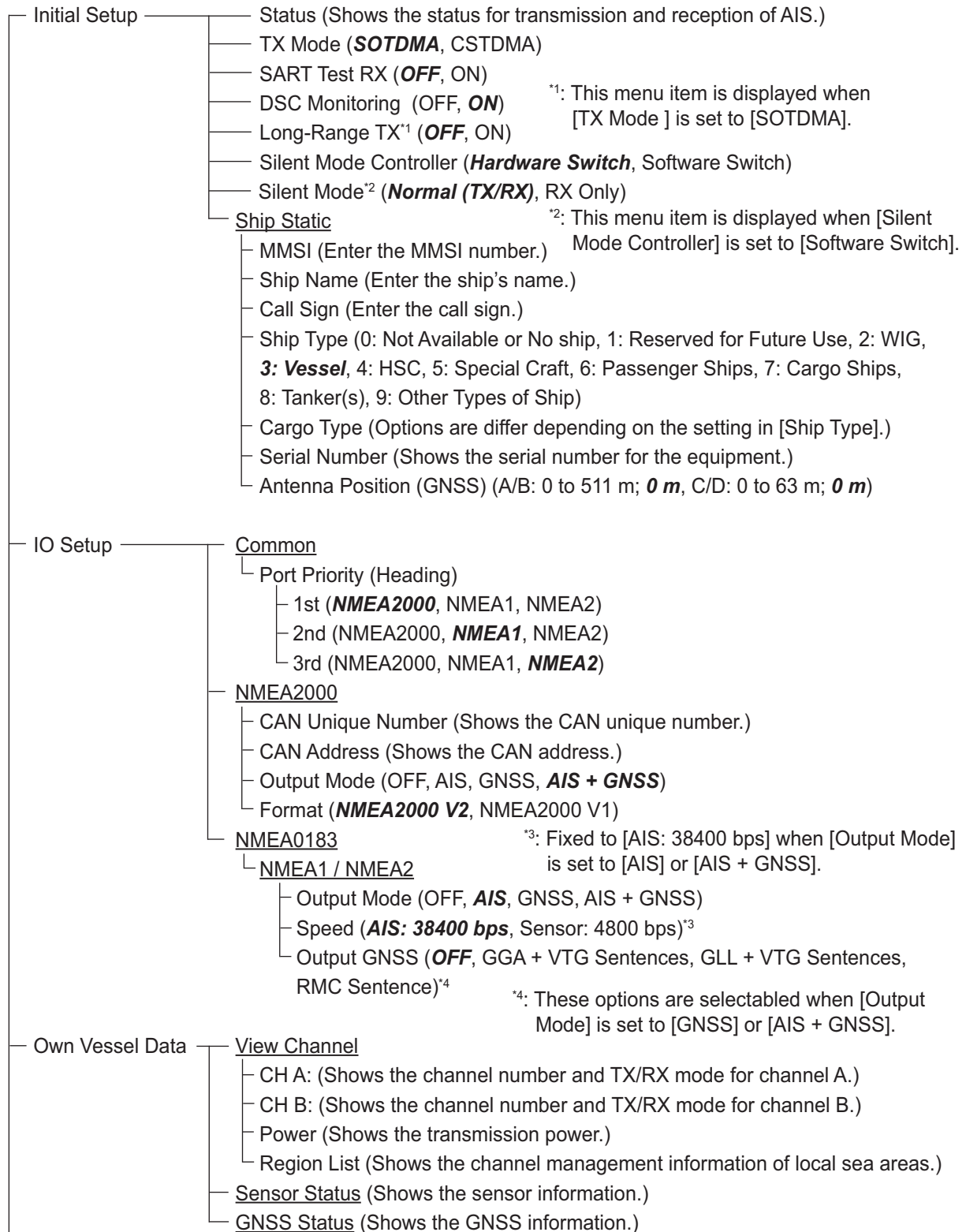

①

APPENDIX 1 MENU TREE

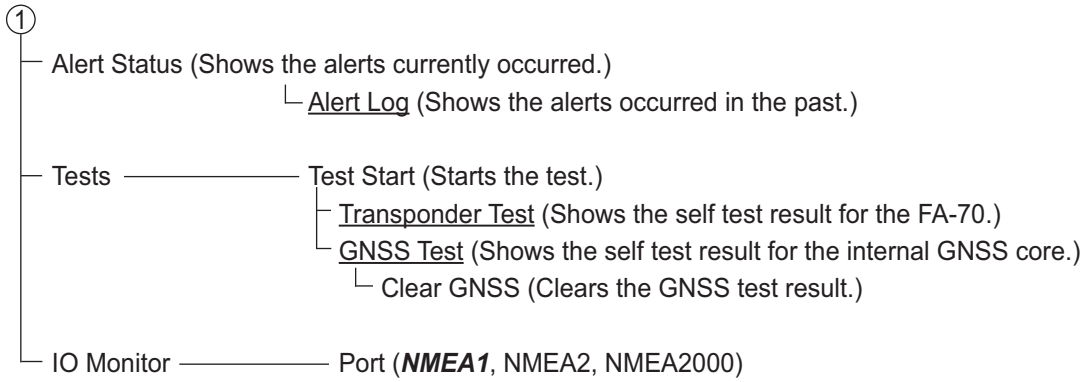

TZTL12F/15F, TZT2BB, TZT9F/12F/16F/19F

On the home screen, select [Settings] - [Initial Setup] - [NETWORK SENSOR SETUP] - [FA-70] in order to display the menus.

Menu

Bold italic: Default

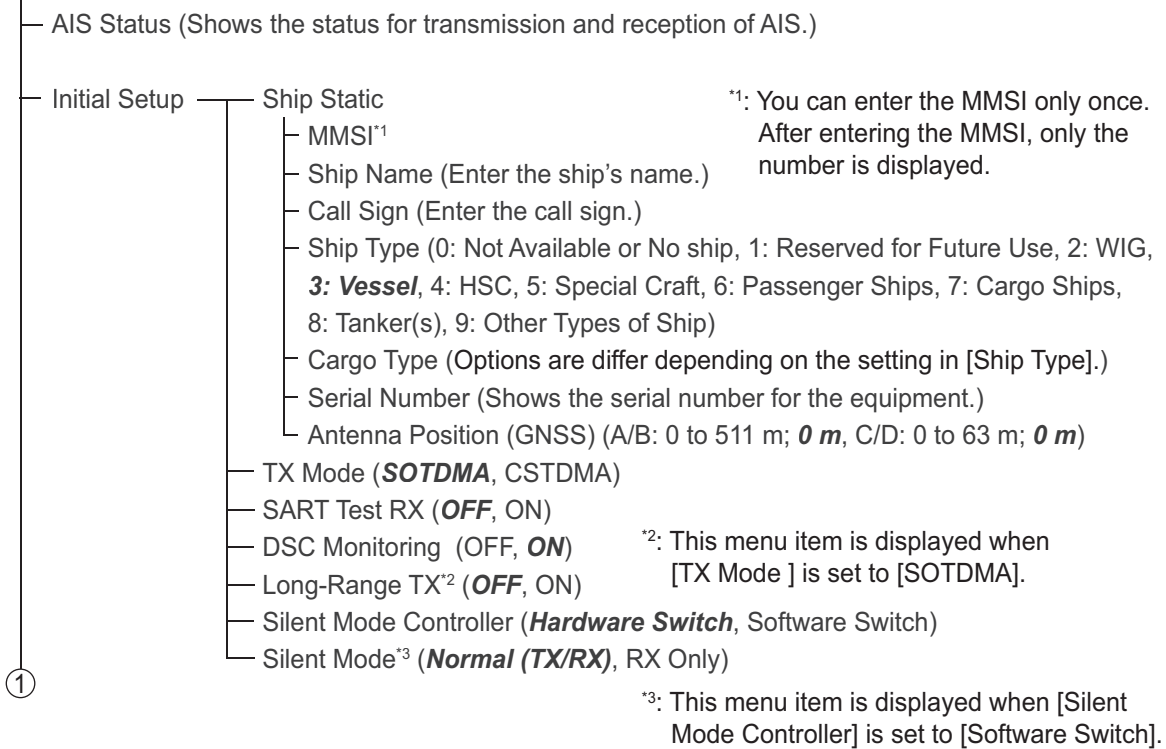

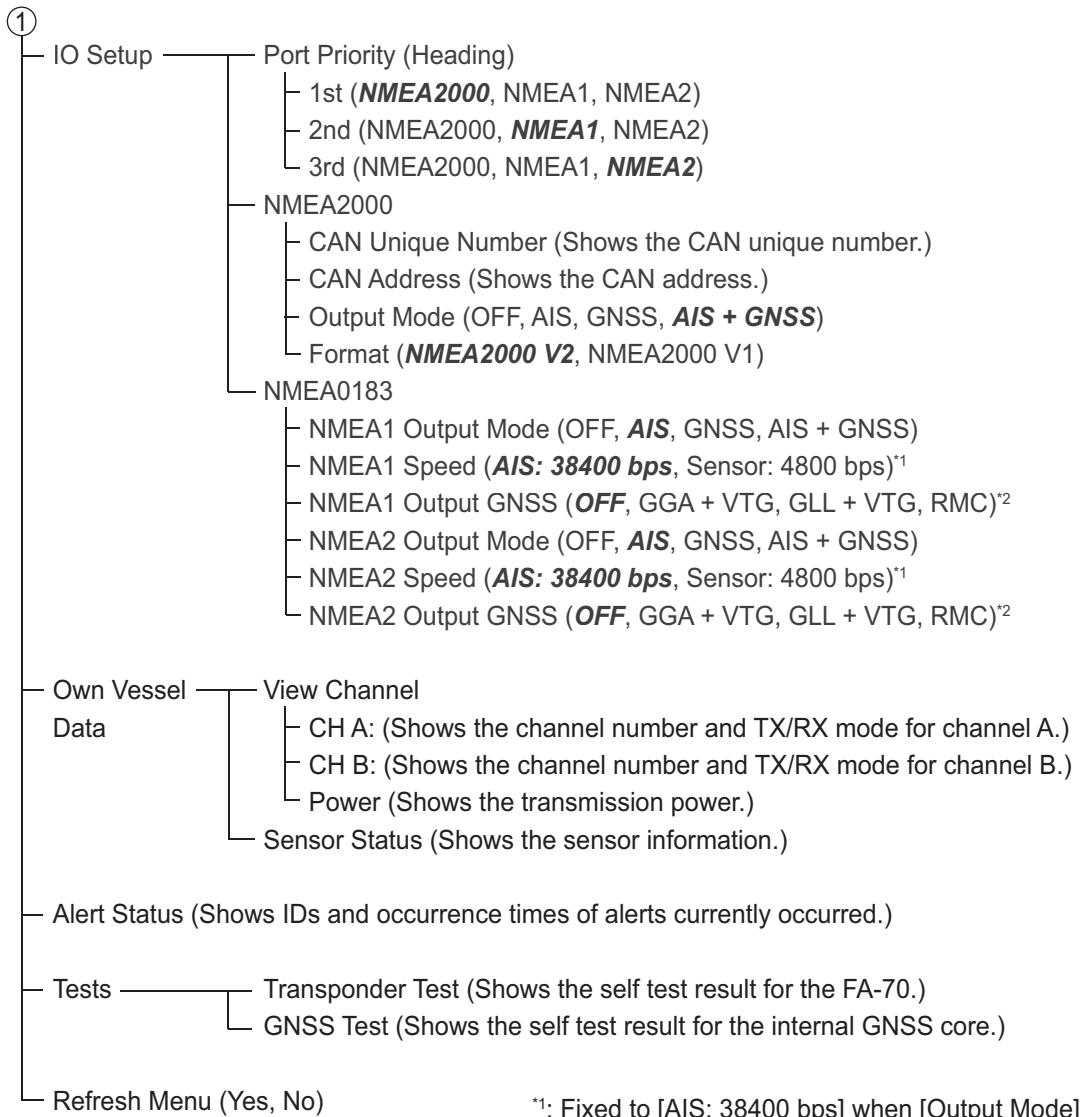

*1: Fixed to [AIS: 38400 bps] when [Output Mode] is set to [AIS] or [AIS + GNSS].

*2: These options are selectable when [Output Mode] is set to [GNSS] or [AIS + GNSS].

APPENDIX 2 ALERT LISTS

The table below shows the alert ID, text, meaning and remedy for each alert.

ID	Text	Meaning	Remedy
001	TX Malfunction	Transmission failure occurred. (The ERROR LED lights in red or orange.)	<p><u>Reasons: RF AMP Too Hot, Regulator For RF AMP Too Hot, VSWR Exceeds Limit, Current to RF AMP Regulated</u> Check the VHF antenna and FA-70 connections.</p> <p><u>Reason: TX PLL Error, TX Power Abnormal</u> Contact your dealer.</p> <p><u>Reason: No MMSI</u> Check that the own ship MMSI is set.</p> <p><u>Reason: Noise Level Too High</u> Check noise sources near the antenna.</p>
002	Antenna VSWR Exceeds Limit	High VSWR for the AIS antenna detected. (Continued operation possible.)	Check the VHF antenna. If the problem is not rectified, contact your dealer.
003	RX Channel 1 Malfunction	RX1 hardware trouble. Transmission stopped on corresponding TX channel. (The ERROR LED lights in red.)	Circuit board may be damaged. Contact your dealer.
004	RX Channel 2 Malfunction	RX2 hardware trouble. Transmission stopped on corresponding TX channel. (The ERROR LED lights in red.)	
007	UTC Sync Invalid	Internal GPS has no fix. (Continued operation possible using indirect or semaphore synchronization.)	Check the GPS antenna connection. If the error appears frequently, contact your dealer.
026	No Position Sensor in Use	No L/L data. (Continued operation possible.)	
029	No Valid SOG Information	Invalid SOG data. (Continued operation possible.)	
030	No Valid COG Information	Invalid COG data. (Continued operation possible.)	

APPENDIX 3 NMEA2000/0183 INPUT/ OUTPUT DATA

CAN bus (NMEA2000) input/output

Input PGN

PGN	Description
059392	ISO Acknowledgment
059904	ISO Request
060160	ISO Transport Protocol, Data Transfer
060416	ISO Transport Protocol, Connection Management - BAM Group Function
060928	ISO Address Claim
065240	ISO Commanded Address
126208	NMEA - Request Group Function
	NMEA - Command Group Function
127250	Vessel Heading

Output PGN

PGN	Description	Output cycle ^{*1} (ms)
059392	ISO Acknowledgment	
059904	ISO Request	
060928	ISO Address Claim	
126208	NMEA - Acknowledge Group Function	
126464	PGN List - Transmit PGN's Group Function	*2
	PGN List - Received PGN's Group Function	
126992	System Time	1,000
126993	Heartbeat	60,000
126996	Product Information	*2
126998	Configuration Information	*2
127258	Magnetic Variation	1,000
129025	Position, Rapid Update	100
129026	COG & SOG, Rapid Update	250
129029	GNSS Position Data	1,000
129038	AIS Class A Position Report	
129039	AIS Class B Position Report	
129040	AIS Class B Extended Position Report	
129041	AIS Aids to Navigation (AtoN) Report	
129540	GNSS Sats in View	1,000
129792	AIS DGNSS Broadcast Binary Message	
129793	AIS UTC and Date Report	
129794	AIS Class A Static and Voyage Related Data	
129795	AIS Addressed Binary Message	*3
129796	AIS Acknowledge	
129797	AIS Binary Broadcast Message	
129798	AIS SAR Aircraft Position Report	
129801	AIS Addressed Safety Related Message	

APPENDIX 3 NMEA2000/0183 INPUT/OUTPUT DATA

PGN	Description	Output cycle ^{*1} (ms)
129802	AIS Safety Related Broadcast Message	
129803	AIS Interrogation	
129804	AIS Assignment Mode Command	*3
129805	AIS Data Link Management Message	
129806	AIS Channel Management	
129807	AIS Group Assignment	
129809	AIS Class B "CS" Static Data Report, Part A	
129810	AIS Class B "CS" Static Data Report, Part B	
129811	AIS Single Slot Binary Message	
129812	AIS Multi Slot Binary Message	*3
129813	AIS Long - Range Broadcast Message	*3

*1: Output cycle for an AIS related PGN depends on vessel traffic conditions.

*2: Outputs when receiving output request.

*3: SOTDMA mode only

NMEA0183 input/output

Sentence	Description	Input	Output
ABM	AIS Addressed and Binary Broadcast Acknowledgement	*	
ABK	AIS Addressed and Binary Broadcast Acknowledgement		✓
ACA	AIS Regional Channel Assignment Message		✓
ACK	Acknowledge Alarm	✓	
ACS	AIS Channel Management Information Source		✓
AIQ	Query Sentence	✓	
ALR	Set Alarm State		✓
BBM	AIS Broadcast Binary Message	*	
GGA	Global Positioning System Fix Data		✓
GLL	Geographic Position - Latitude/Longitude		✓
HDT	Heading, True	✓	
RMC	Recommended Minimum Specific GNSS Data		✓
SSD	AIS Ship Static Data	✓	✓
THS	True Heading and Status	✓	
TXT	Text Transmission		✓
VDM	AIS VHF Data-Link Message		✓
VDO	AIS VHF Data-Link Own-Vessel Report		✓
VER	Version		✓
VSD	AIS Voyage Static Data	✓	✓
VTG	Course Over Ground & Ground Speed		✓

*: SOTDMA mode only

APPENDIX 4 RADIO REGULATORY INFORMATION

USA-Federal Communications Commission (FCC)

This device complies with part 15 of the FCC Rules. Operation is subject to the following two conditions:

- (1) This device may not cause harmful interference, and
- (2) This device must accept any interference received, including interference that may cause undesired operation. Any changes or modifications not expressly approved by the party responsible for compliance could void the user's authority to operate the equipment.

Caution: Exposure to Radio Frequency Radiation

- This equipment complies with FCC radiation exposure limits set forth for an uncontrolled environment and meets the FCC radio frequency (RF) Exposure Guidelines in Supplement C to OET65.
- This equipment should be installed and operated keeping the radiator at least 20 cm or more away from person's body.
- This device must not be co-located or operating in conjunction with any other antenna or transmitter.

Innovation, Science and Economic Development Canada (ISED)

Caution: Exposure to Radio Frequency Radiation

This equipment complies with ISED radiation exposure limits set forth for an uncontrolled environment and meets RSS-102 of the ISED radio frequency (RF) Exposure rules. This equipment should be installed and operated keeping the radiator at least 20 cm or more away from person's body.

Cet équipement est conforme aux limites d'exposition aux rayonnements énoncées pour un environnement non contrôlé et respecte les règles d'exposition aux fréquences radioélectriques (RF) CNR-102 de l'ISED. Cet équipement doit être installé et utilisé en gardant une distance de 20 cm ou plus entre le dispositif rayonnant et le corps.

To reduce potential radio interference to other users, the antenna type and its gain should be so chosen that the equivalent isotropically radiated power (EIRP) is not more than that required for successful communication.

**SPECIFICATIONS OF CLASS B AIS TRANSPONDER
FA-70**

1 GENERAL

1.1	Type	Class B AIS Transponder
1.2	RX capacity	2250 report/minute, 1 channel 4500 report/minute, 2 channel
1.3	RX system	SOTDMA or CSTDMA (user select), dual wave simultaneous reception
1.4	Synchronous framing	UTC direct or UTC indirect (SOTDMA) UTC direct (CSTDMA)
1.5	Operating mode	Autonomous, Assigned, polled/interrogation response
1.6	Frequency switching	Automatic
1.7	DSC receiving	Time sharing system
1.8	Initialization	Within 2 minutes after power-on
1.9	Prevention of abnormal TX	Auto-suspended for detecting TX more than 1 second
1.10	Regulations	IEC 62287-1/2

2 TRANSMITTER

2.1	Frequency range	156.025 MHz to 162.025 MHz (F1D)
2.2	Output power	5 W or 1W (SOTDMA), 2 W (CSTDMA)
2.3	Modulation	GMSK
2.4	Channel interval	25 kHz
2.5	Frequency deviation	±500 Hz
2.6	Spurious emission	9 kHz to 1 GHz, -36 dBm or less 1 GHz to 4 GHz, -30 dBm or less
2.7	Transmission interval	
	SOTDMA	5 s (SOG>23 kn), 15 s (14<SOG≤23 kn), 30 s (2<SOG≤14 kn), 3 min. (SOG≤2 kn)
	CSTDMA	30 s (SOG>2 kn), 3 min. (SOG≤2 kn)

3 AIS RECEIVER

3.1	Frequency range	156.025 MHz to 162.025 MHz (F1D)
3.2	Oscillator frequency	1 st local oscillator: f+ (46.35/58.05 MHz), 2 nd local oscillator: 45.9/57.6 MHz
3.3	Intermediate frequency	1 st : 46.35/58.05 MHz, 2 nd : 450 kHz
3.4	Receiving method	Double super heterodyne
3.5	Sensitivity	-107 dBm or less (PER20% or less)
3.6	Error at high input level	-77 dBm (PER2% or less), -7 dBm (PER10% or less)
3.7	Co-channel rejection	-10 dB or more
3.8	Adjacent channel selectivity	70 dB or more
3.9	Spurious response	70 dB or more
3.10	Inter-modulation	65 dB or more
3.11	Sensitivity suppression	86 dB or more (±5 MHz, ±10 MHz)

4 DSC RECEIVER (TIMESHARING SYSTEM)

4.1	Frequency	156.525 MHz (CH70)
4.2	Sensitivity	-107 dBm (BER1% or less)
4.3	Error at high input level	-7 dBm (BER1% or less)
4.4	Co-channel rejection	-10 dB or more
4.5	Adjacent channel selectivity	70 dB or more
4.6	Spurious response	70 dB or more
4.7	Inter-modulation	65 dB or more
4.8	Sensitivity suppression	84 dB or more

5 VHF SPLITTER

5.1	Rx function	
	Frequency range	155 MHz to 164 MHz
	Insertion loss	0 dB typical
5.2	Tx function	
	Frequency range	155 MHz to 164 MHz
	Insertion loss	1 dB or less
	Input power	25 W max.
	Power detection	0.1 W or more

6 GPS RECEIVER

6.1	Number of channel	12 channels parallel
6.2	Receiving frequency	1575.42 MHz, C/A code
6.3	Position accuracy	13 m or less (2drms, HDOP≤4)
6.4	Tracking velocity	1000 kn
6.5	Position fixing time	90 s approx.
6.6	Update interval	1 s
6.7	DGPS data correcting	By AIS information

7 INTERFACE

7.1	Number of port	
	Serial	2 ports, IEC61162-1, 4800/38400 bps
	NMEA2000	1 port, External power required 12-24VDC (9-32V), LEN=1@9V
	USB	1 port, USB2.0, Full speed, for maintenance
	Contact closure	1 port, for silent switch
7.2	Data sentence	
	Input	ABM*, ACK, AIQ, BBM*, HDT, SSD, THS, VSD
	Output	ABK, ACA, ACS, ALR, GGA, GLL, RMC, SSD, TXT, VDM, VDO, VER, VSD, VTG
		*: SOTDMA only
7.3	Output P sentence	
	PFEC	pidat
7.4	NMEA2000 PGN	
	Input	059392/904, 060160/416/928, 065240, 126208, 127250
	Output	059392/904, 060928, 126208/464/992/993/996/998, 127258, 129025/026/029/038/039/040/041/540,

129792/793/794/795*/796/797/798,
129801/802/803/804*/805/806/807/809/810/811/812*/813*
*: SOTDMA only

8 POWER SUPPLY

12-24 VDC (9.6-31.2 V): 1.8-0.9 A (TX), 0.3-0.2 A (RX)

9 ENVIRONMENTAL CONDITIONS

9.1 Ambient temperature

Antenna unit -25°C to +70°C

Transponder -15°C to +55°C

9.2 Relative humidity 93% or less at +40°C

9.3 Degree of protection

Antenna unit IP56

Transponder IP55

9.4 Vibration IEC 60945 Ed.4

10 UNIT COLOR

10.1 Antenna unit N9.5

10.2 Transponder N1.0

PACKING LIST

05EW-X-9853 -3 1/1

FA-70-E/-E-S

A-1

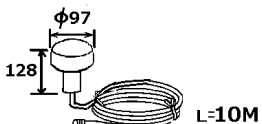
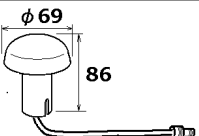
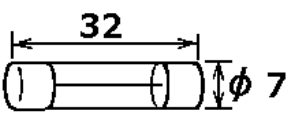
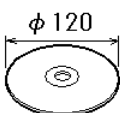
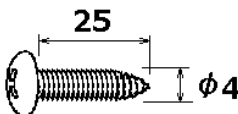
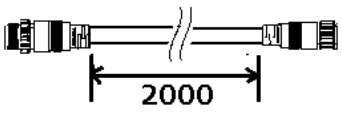
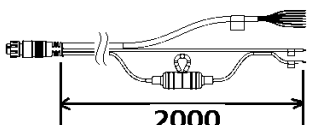
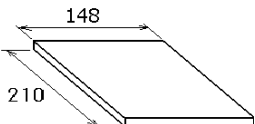
NAME	OUTLINE	DESCRIPTION/CODE No.	Q'TY
ユニット UNIT			
簡易船舶識別装置 CLASS B AIS TRANSPONDER		FA-70	1
		999-999-551-10	(*)
アンテナ ANTENNA UNIT		GPA-C01	1
		000-194-113-13	(*1)
アンテナ ANTENNA UNIT		GPA-017S	1
		000-192-734-12	(*2)
予備品 SPARE PARTS			
ヒューズ TUBE FUSE		250VAC 5A	2
		999-999-551-40	(*)
付属品 ACCESSORIES			
AISセッティングツール AIS SETTING TOOL		FA70/60/40 SW *CD*	1
		000-197-449-10	
工事材料 INSTALLATION MATERIALS			
+トラスタップ・ソケット TAPPING SCREW		PA4x25	4
		999-999-551-70	(*)
NMEA2000ケーブル NMEA2000 CABLE		NPD-MM1MF1000G02M	1
		999-999-551-60	(*)
電源ケーブル PWR/NMEA1/SILENT CABLE		6111000000101	1
		999-999-551-50	(*)
図書 DOCUMENT			
取扱説明書(英) OPERATOR'S MANUAL (EN)		OME-45150-*	1
		000-197-396-1*	

- (*)は、ダミーコードに付き、注文できません。
- (*) THIS CODE CANNOT BE ORDERED.
- (*1)は、FA-70-E用です。
- (*1): FOR FA-70-E.
- (*2)は、FA-70-E-S用です。
- (*2): FOR FA-70-E-S.

(略図の寸法は、参考値です。 DIMENSIONS IN DRAWING FOR REFERENCE ONLY.)

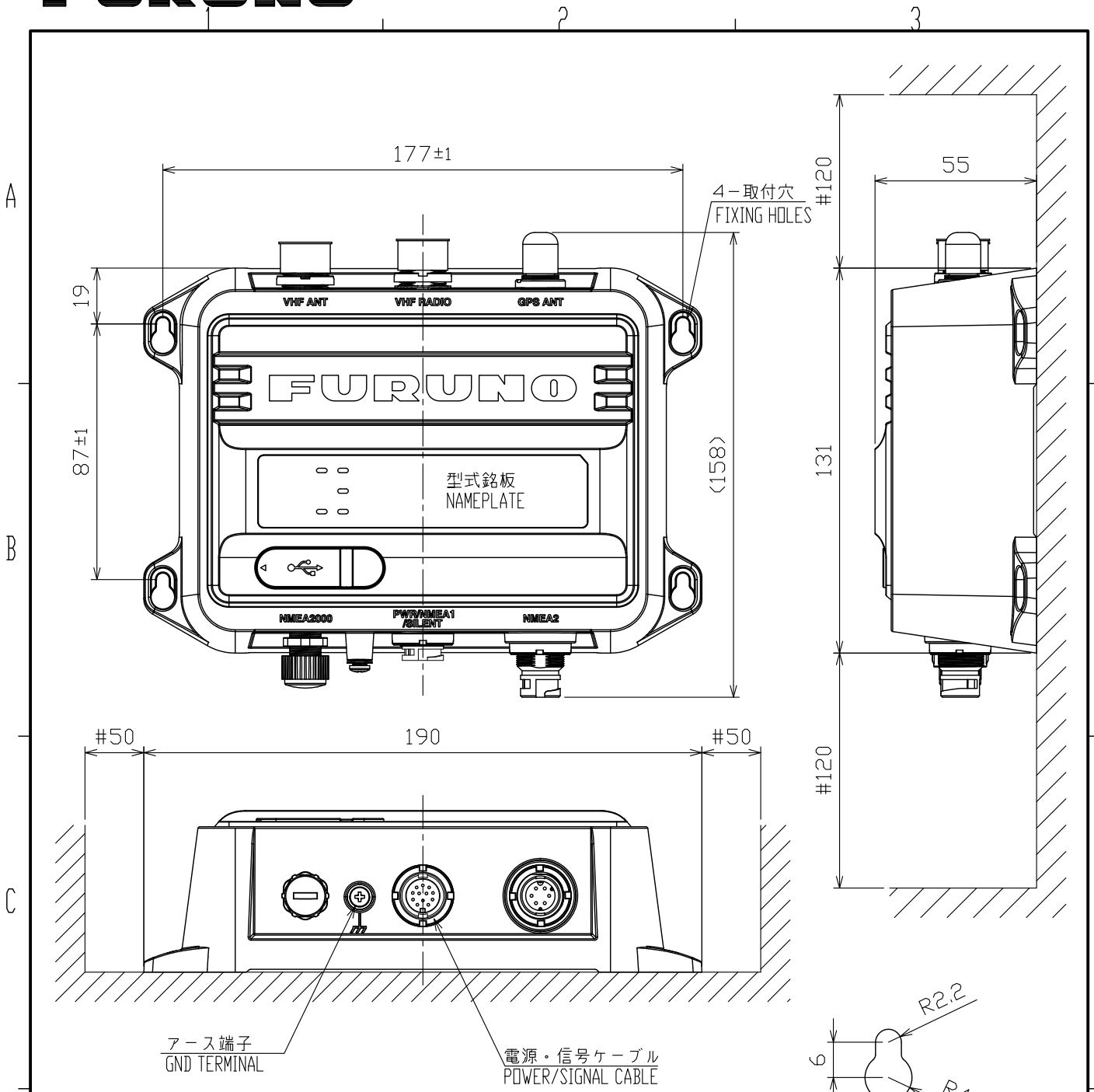

取付穴詳細 (尺度: 1 / 1)
DETAIL FOR FIXING (SCALE: 1/1)

注記

- 1) 指定なき寸法公差は表 1 による。
- 2) #印寸法は最小サービス空間寸法とする。
- 3) 取付用ねじはトラスタッピンネジ呼び径 4×25 を使用のこと。

NOTE

1. TABLE 1 INDICATES TOLERANCE OF DIMENSIONS WHICH IS NOT SPECIFIED.
2. #: MINIMUM SERVICE CLEARANCE.
3. USE TAPPING SCREWS $\phi 4 \times 25$ FOR FIXING THE UNIT.

表 1 TABLE 1

寸法区分(mm) DIMENSION	公差(mm) TOLERANCE
$0 < L \leq 50$	± 1.5
$50 < L \leq 100$	± 2.5
$100 < L \leq 500$	± 3

DRAWN 14/Jan/2020 T.YAMASAKI		TITLE FA-70
CHECKED 14/Jan/2020 H.MAKI		名称 簡易型船舶自動識別装置 (壁掛・卓上装備)
APPROVED 28/Jan/2020 H.MAKI		外寸図
SCALE MASS $0.52 \pm 10\%$ kg	質量はケーブルを含まず。 MASS DOES NOT INCLUDE CABLE.	NAME CLASS B AIS TRANSPONDER (BULKHEAD/TABLETOP MOUNT)
DWG. No. C4515-G01-F	REF. No.	OUTLINE DRAWING

表1 TABLE 1

寸法区分(mm) DIMENSION	公差(mm) TOLERANCE
0 < L ≤ 50	±1.5
50 < L ≤ 100	±2.5
100 < L ≤ 500	±3



表2 TABLE 2

型式 TYPE	ケーブル長 (m) CABLE LENGTH	プラグ PLUG	質量(kg±10%) MASS
GPA-C01	10.2	TNC-P-3	0.53
GPA-C01S	0.18	TNC-J-3	0.2

注記

1) 指定なき寸法公差は表1による。

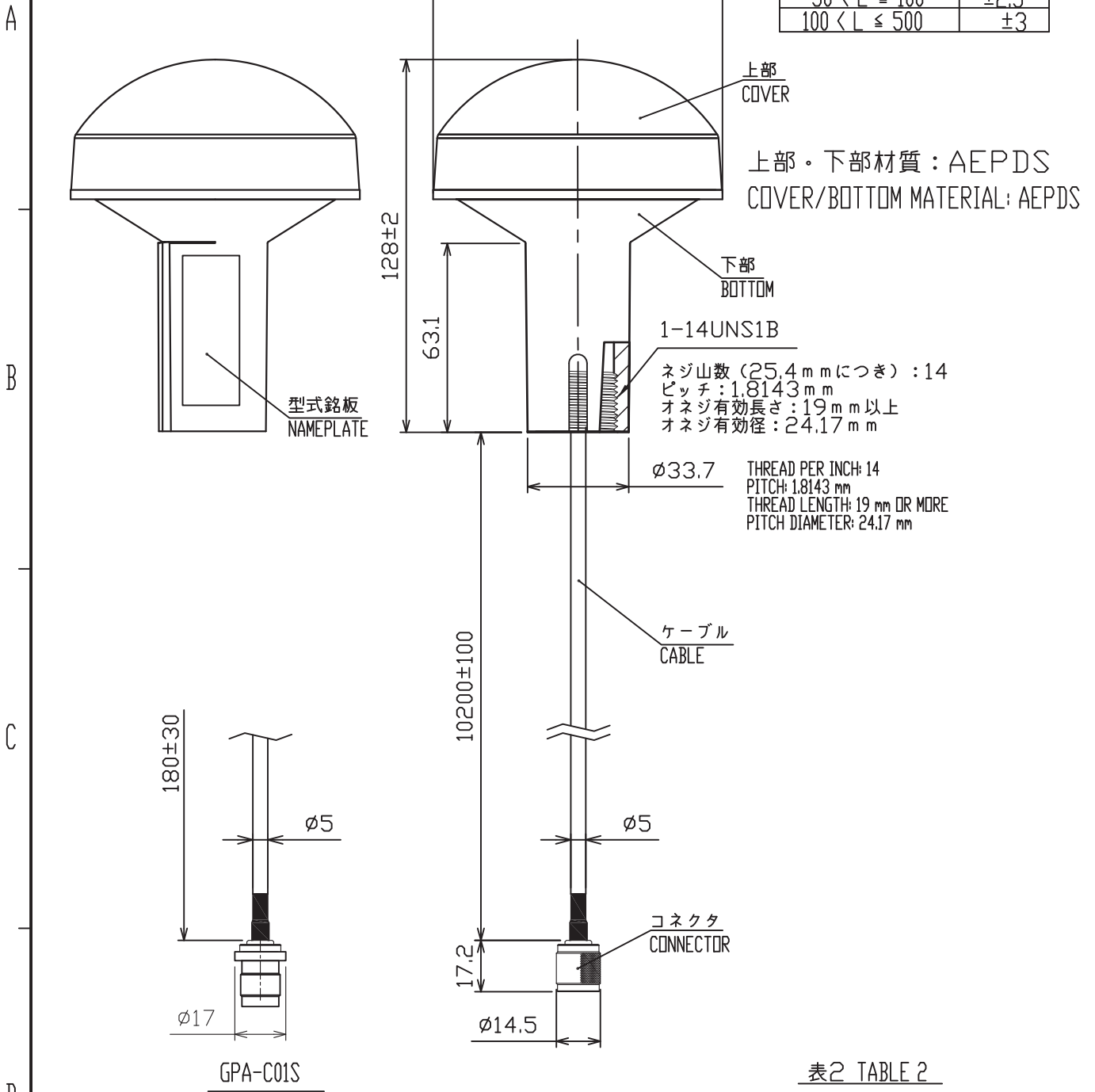
NOTE

1. TABLE 1 INDICATES TOLERANCE OF DIMENSIONS WHICH IS NOT SPECIFIED.

DRAWN	26/Jan/2021 T.YAMASAKI	TITLE	GPA-C01/C01S
CHECKED	26/Jan/2021 H.MAKI	名称	空中線部
APPROVED	28/Jan/2021 H.MAKI	GP-39	外寸図
SCALE	1/2	質量 表2参照 TABLE 2	質量はケーブルを含む。 MASS INCLUDES CABLE.
DWG. No.	C4494-G04-C	REF. No.	NAME ANTENNA UNIT OUTLINE DRAWING



表1 TABLE 1

寸法区分(mm) DIMENSION	公差(mm) TOLERANCE
L ≤ 50	±1.5
50 < L ≤ 100	±2.5
100 < L ≤ 500	±3

1-14UNS1B

ねじ山数 (25.4mmにつき) : 14
 ピッチ : 1.8143 mm
 オネジ有効長さ : 19 mm以上
 オネジ有効径 : 24.17mm

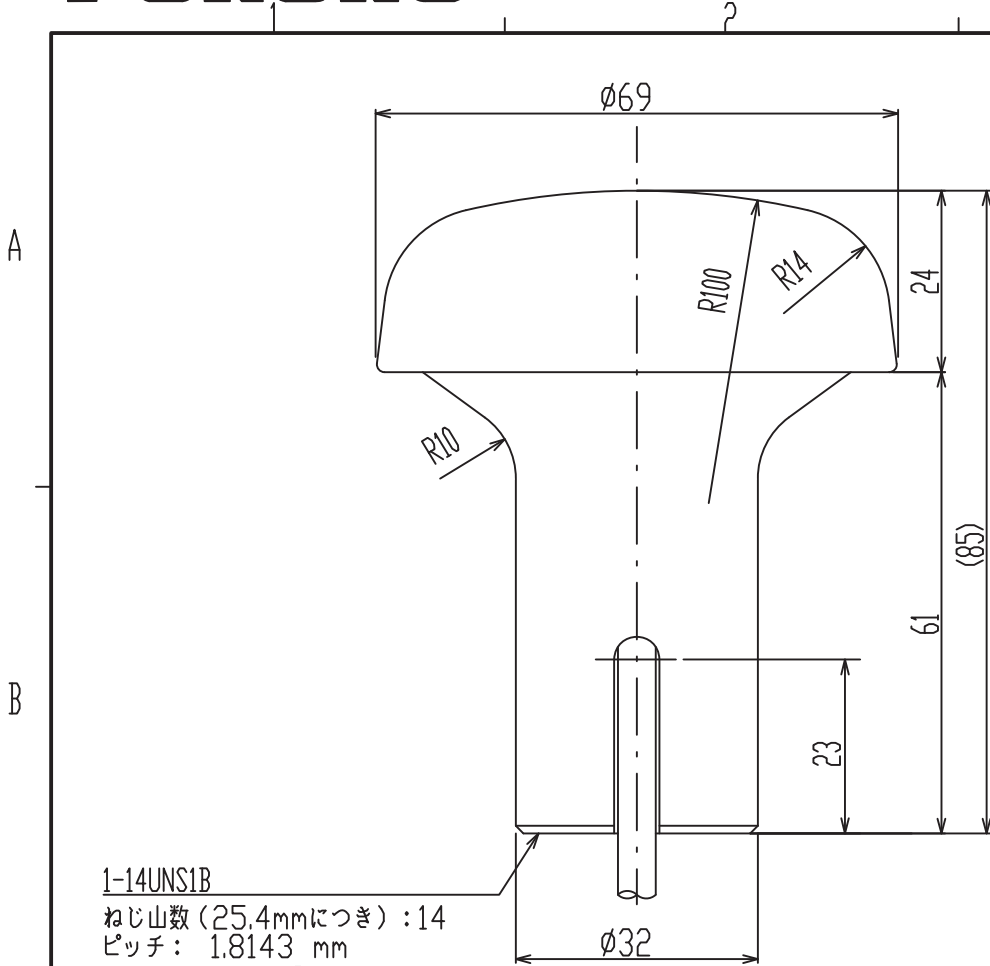
THREAD PER 25.4mm (1 INCH): 14
 PITCH: 1.8143 mm
 THREAD LENGTH: 19 mm OR MORE
 PITCH DIAMETER: 24.17mm



表2 TABLE 2

型式 TYPE	ケーブル長(m) CABLE LENGTH	プラグ PLUG	質量(kg±10%) MASS
GPA-017	10	TNC-P-3	0.6
GPA-017S	0.2	TNC-J-3	0.15

注記
 指定外の寸法公差は表1による。

NOTE
 TABLE 1 INDICATES TOLERANCE OF DIMENSIONS WHICH IS NOT SPECIFIED.

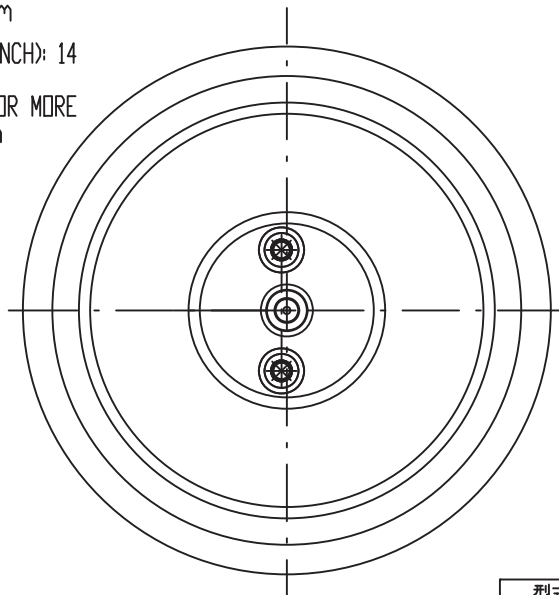
DRAWN Mar. 27 '07 T.YAMASAKI	TITLE GPA-017/017S
CHECKED Mar. 27 '07 T.TAKENO	名称 空中線部
APPROVED Mar. 27 '07 R.Esumi	外寸図
SCALE MASS TABLE 2 表2参照	NAME ANTENNA UNIT
DWG.No. C4384-G04- L	OUTLINE DRAWING

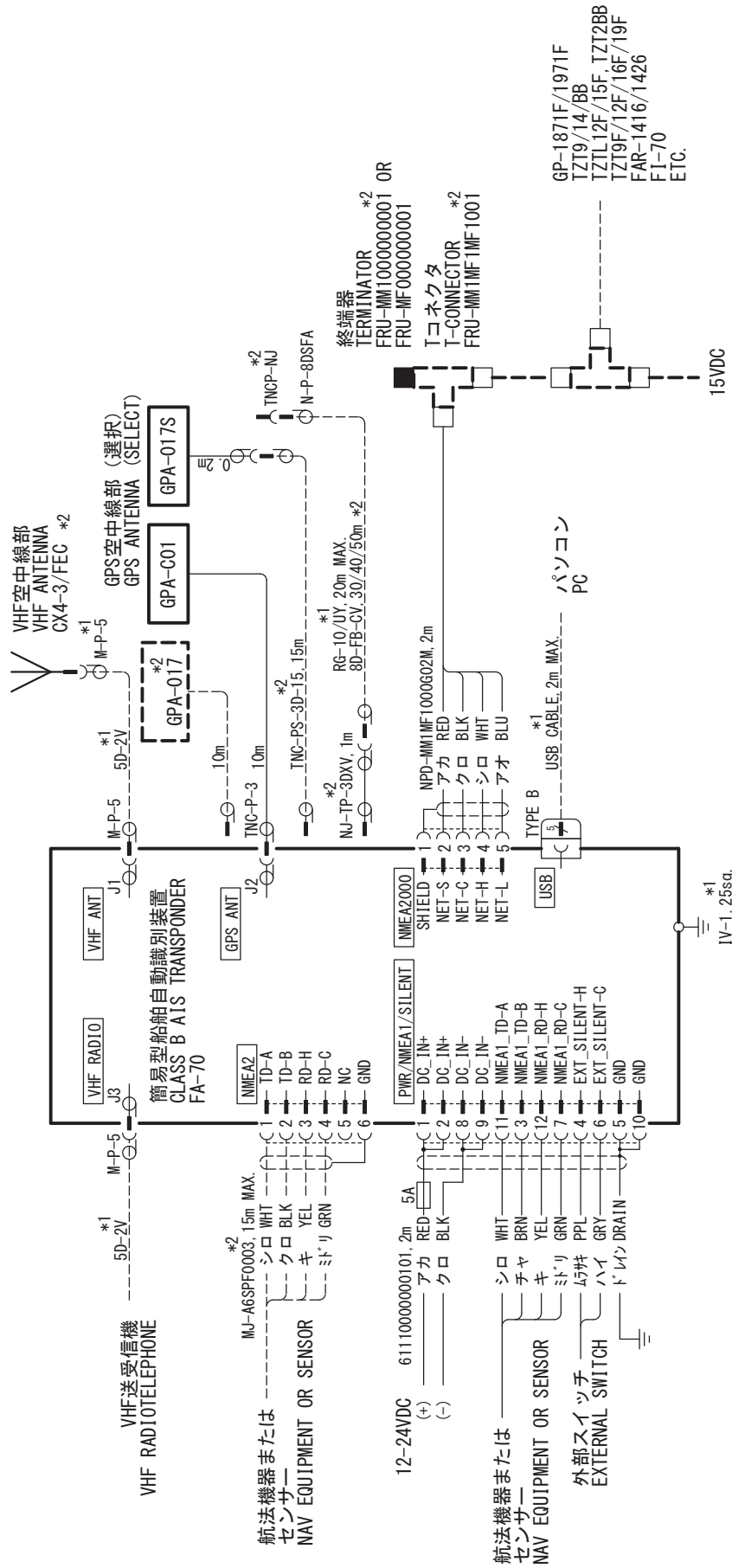

注記
 * 1) 造船所手配。
 * 2) オプション。

NOTE
 * 1: SHIPYARD SUPPLY.
 * 2: OPTION.

DRAWN	18/Feb/2021 T. YAMASAKI	TITLE	FA-70
CHECKED	18/Feb/2021 H. MAKI	名称	簡易型船舶自動識別装置
APPROVED	19/Feb/2021 H. MAKI		相互結線図
SCALE	MASS kg	NAME	CLASS B AIS TRANSPONDER
DWG. No.	C4515-C01-E	REF. No.	05-113-1001-0
		INTERCONNECTION DIAGRAM	

Declaration of Conformity

[FA-70]

- Bulgarian (BG)** С настоящото Furuno Electric Co., Ltd. декларира, че гореспоменат тип радиосъоръжение е в съответствие с Директива 2014/53/ЕС, СИ 2017/1206. Цялостният текст на ЕС/УК декларацията за съответствие може да се намери на следния интернет адрес:
- Spanish (ES)** Por la presente, Furuno Electric Co., Ltd. declara que el tipo de equipo radioeléctrico arriba mencionado es conforme con la Directiva 2014/53/UE, SI 2017/1206. El texto completo de la declaración de conformidad de la EU/UK está disponible en la siguiente dirección Internet:
- Czech (CS)** Tímto Furuno Electric Co., Ltd. prohlašuje, že výše zmíněné typ rádiového zařízení je v souladu se směrnicí 2014/53/EU, SI 2017/1206. Úplné znění EU/SK prohlášení o shodě je k dispozici na této internetové adrese:
- Danish (DA)** Hermed erklærer Furuno Electric Co., Ltd., at ovennævnte radioudstyr er i overensstemmelse med direktiv 2014/53/EU, SI 2017/1206. EU/UK-overensstemmelseserklæringens fulde tekst kan findes på følgende internetadresse:
- German (DE)** Hiermit erklärt die Furuno Electric Co., Ltd., dass der oben genannte Funkanlagentyp der Richtlinie 2014/53/EU, SI 2017/1206 entspricht. Der vollständige Text der EU/UK-Konformitätserklärung ist unter der folgenden Internetadresse verfügbar:
- Estonian (ET)** Käesolevaga deklareerib Furuno Electric Co., Ltd., et ülalmainitud raadioseadme tüüp vastab direktiivi 2014/53/EL, SI 2017/1206 nõuetele. EL/GB vastavusdeklaratsiooni täielik tekst on kättesaadav järgmisel internetiaadressil:
- Greek (EL)** Με την παρούσα η Furuno Electric Co., Ltd., δηλώνει ότι ο προαναφερθέντας ραδιοεξοπλισμός πληροί την οδηγία 2014/53/ΕΕ, SI 2017/1206. Το πλήρες κείμενο της δήλωσης συμμόρφωσης ΕΕ/UK διατίθεται στην ακόλουθη ιστοσελίδα στο διαδίκτυο:
- English (EN)** Hereby, Furuno Electric Co., Ltd. declares that the above-mentioned radio equipment type is in compliance with Directive 2014/53/EU, SI 2017/1206. The full text of the EU/UK declaration of conformity is available at the following internet address:
- French (FR)** Le soussigné, Furuno Electric Co., Ltd., déclare que l'équipement radioélectrique du type mentionné ci-dessus est conforme à la directive 2014/53/UE, SI 2017/1206. Le texte complet de la déclaration UE/RU de conformité est disponible à l'adresse internet suivante:
- Croatian (HR)** Furuno Electric Co., Ltd. ovime izjavljuje da je gore rečeno radijska oprema tipa u skladu s Direktivom 2014/53/EU, SI 2017/1206. Cjeloviti tekst EU/UK izjave o sukladnosti dostupan je na sljedećoj internetskoj adresi:
- Italian (IT)** Il fabbricante, Furuno Electric Co., Ltd., dichiara che il tipo di apparecchiatura radio menzionato sopra è conforme alla direttiva 2014/53/UE, SI 2017/1206. Il testo completo della dichiarazione di conformità UE/RU è disponibile al seguente indirizzo Internet:
- Latvian (LV)** Ar šo Furuno Electric Co., Ltd. deklarē, ka augstāk minēts radioiekārta atbilst Direktīvai 2014/53/ES, SI 2017/1206. Pilns ES/AK atbilstības deklarācijas teksts ir pieejams šādā interneta vietnē:

- Lithuanian (LT) Aš, Furuno Electric Co., Ltd., patvirtinu, kad pirmiau minėta radijo įrenginių tipas atitinka Direktyvą 2014/53/ES, SI 2017/1206.
Visas ES/JK atitikties deklaracijos tekstas prieinamas šiuo interneto adresu:
- Hungarian (HU) Furuno Electric Co., Ltd. igazolja, hogy fent említett típusú rádióberendezés megfelel a 2014/53/EU, SI 2017/1206 irányelvnek.
Az EU/EK-megfelelőségi nyilatkozat teljes szövege elérhető a következő internetes címen:
- Maltese (MT) B'dan, Furuno Electric Co., Ltd., niddikjara li msemmija hawn fuq-tip ta' taghmir tar-radju huwa konformi mad-Direttiva 2014/53/UE, SI 2017/1206.
It-test kollu tad-dikjarazzjoni ta' konformità tal-UE/RU huwa disponibbli f'dan l-indirizz tal-Internet li ġej:
- Dutch (NL) Hierbij verklaar ik, Furuno Electric Co., Ltd., dat het hierboven genoemde type radioapparaat conform is met Richtlijn 2014/53/EU, SI 2017/1206.
De volledige tekst van de EU/VK-conformiteitsverklaring kan worden geraadpleegd op het volgende internetadres:
- Polish (PL) Furuno Electric Co., Ltd. niniejszym oświadcza, że wyżej wymieniony typ urządzenia radiowego jest zgodny z dyrektywą 2014/53/UE, SI 2017/1206.
Pełny tekst deklaracji zgodności UE/UK jest dostępny pod następującym adresem internetowym:
- Portuguese (PT) O(a) abaixo assinado(a) Furuno Electric Co., Ltd. declara que o mencionado acima tipo de equipamento de rádio está em conformidade com a Diretiva 2014/53/UE, SI 2017/1206.
O texto integral da declaração de conformidade da EU/UK está disponível no seguinte endereço de Internet:
- Romanian (RO) Prin prezenta, Furuno Electric Co., Ltd. declară că echipamentul radio menționat mai sus este în conformitate cu Directiva 2014/53/UE, SI 2017/1206.
Textul integral al declarației de conformitate UE/RU este disponibil la următoarea adresă internet:
- Slovak (SK) Furuno Electric Co., Ltd. týmto vyhlasuje, že vyššie spomínané rádiové zariadenie typu je v súlade so smernicou 2014/53/EÚ, SI 2017/1206.
Úplné EÚ/SK vyhlásenie o zhode je k dispozícii na tejto internetovej adrese:
- Slovenian (SL) Furuno Electric Co., Ltd. potrjuje, da je zgoraj omenjeno tip radijske opreme skladen z Direktivo 2014/53/EU, SI 2017/1206.
Celotno besedilo izjave EU/ZK o skladnosti je na voljo na naslednjem spletnem naslovu:
- Finnish (FI) Furuno Electric Co., Ltd. vakuuttaa, että yllä mainittu radiolaitetyyppi on direktiivin 2014/53/EU, SI 2017/1206 mukainen.
EU/UK-vaatimustenmukaisuusvakuutuksen täysimittainen teksti on saatavilla seuraavassa internetosoitteessa:
- Swedish (SV) Härmed försäkrar Furuno Electric Co., Ltd. att ovan nämnda typ av radioutrustning överensstämmer med direktiv 2014/53/EU, SI 2017/1206.
Den fullständiga texten till EU/Storbritannien-försäkran om överensstämmelse finns på följande webbadress:

Online Resource

http://www.furuno.com/en/support/red_doc

Notice for radiated immunity

The test for the radiated immunity is performed up to 2.7 GHz only without the special condition of spot frequency being applied. There is a chance that this equipment may interfere with allocated services in the frequency range of 2.7 GHz to 6 GHz, particularly in harbors, rivers, lake banks, etc.