

FURUNO

OPERATOR'S MANUAL

VHF RADIOTELEPHONE

MODEL **FM-8800D/8800S**

ECF

(Elemental Chlorine Free)

The paper used in this manual
is elemental chlorine free.

FURUNO ELECTRIC CO., LTD.

9-52 Ashihara-cho,
Nishinomiya, 662-8580, JAPAN

Telephone : +81-(0) 798-65-2111

Fax : +81-(0) 798-65-4200

• FURUNO Authorized Distributor/Dealer

All rights reserved. Printed in Japan

Pub. No. OME-56420-J3

(DAMI) FM-8800D/S

A : SEP. 2004

J3 : JUN. 01, 2011



* 0 0 0 1 4 9 3 0 1 8 *

IMPORTANT NOTICES

General

- This manual has been authored with simplified grammar, to meet the needs of international users.
- The operator of this equipment must read and follow the descriptions in this manual. Wrong operation or maintenance can cancel the warranty or cause injury.
- Do not copy any part of this manual without written permission from FURUNO.
- If this manual is lost or worn, contact your dealer about replacement.
- The contents of this manual and equipment specifications can change without notice.
- The example screens (or illustrations) shown in this manual can be different from the screens you see on your display. The screens you see depend on your system configuration and equipment settings.
- Save this manual for future reference.
- Any modification of the equipment (including software) by persons not authorized by FURUNO will cancel the warranty.
- All brand and product names are trademarks, registered trademarks or service marks of their respective holders.

How to discard this product

Discard this product according to local regulations for the disposal of industrial waste. For disposal in the USA, see the homepage of the Electronics Industries Alliance (<http://www.eiae.org/>) for the correct method of disposal.

How to discard a used battery

Some FURUNO products have a battery(ies). To see if your product has a battery, see the chapter on Maintenance. Follow the instructions below if a battery is used. Tape the + and - terminals of battery before disposal to prevent fire, heat generation caused by short circuit.

In the European Union

The crossed-out trash can symbol indicates that all types of batteries must not be discarded in standard trash, or at a trash site. Take the used batteries to a battery collection site according to your national legislation and the Batteries Directive 2006/66/EU.



In the USA

The Mobius loop symbol (three chasing arrows) indicates that Ni-Cd and lead-acid rechargeable batteries must be recycled. Take the used batteries to a battery collection site according to local laws.



Ni-Cd



Pb

In the other countries

There are no international standards for the battery recycle symbol. The number of symbols can increase when the other countries make their own recycling symbols in the future.



SAFETY INSTRUCTIONS

WARNING



Do not open the equipment.

Hazardous voltage which can cause electrical shock, burn or serious injury exists inside the equipment. Only qualified personnel should work inside the equipment.



Do not approach the antenna closer than 0.9 m (MPE by FCC) when it is transmitting.

The antenna emits radio waves which can be harmful to the human body.

	RF power density on antenna aperture	Distance	Description required by
FM-8800D/ 8800S	100 W/m ²	0.11 m	IEC 60945
	10 W/m ²	0.33 m	IEC 60945
	2 W/m ²	0.9 m	MPE by FCC

(MPE: Minimum Permissible Exposure)

Do not disassemble or modify the equipment.

Fire, electrical shock or serious injury can result.

Turn off the power immediately if water leaks into the equipment or the equipment is emitting smoke or fire.

Continued use of the equipment can cause fire or electrical shock.

Do not place liquid-filled containers on the top of the equipment.

Fire or electrical shock can result if a liquid spills into the equipment.

WARNING

Do not operate the equipment with wet hands.

Electrical shock can result.

Keep heater away from equipment.

Heat can alter equipment shape and melt the power cord, which can cause fire or electrical shock.

Any repair work must be done by a licensed radio technician.

Improper repair work can cause electrical shock or fire.

CAUTION

Do not touch any part of the antenna when the equipment is transmitting.

Electrical shock can result.

Use the proper fuse.

Use of a wrong fuse can result in fire or cause permanent damage to the equipment.

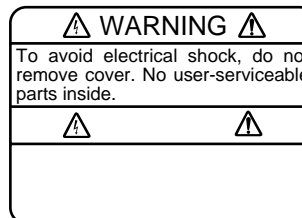

Terminal, Communication Unit

Name: Warning Label (1)

Type: 86-003-1011

Code No.: 100-236-231

DISTRESS ALERT TRANSMISSION

Transmit the distress alert when a life-endangering situation occurs on your vessel.

1. Open the **DISTRESS** key cover and press the **DISTRESS** key more than four seconds.
2. Wait until the distress acknowledge is received.

Distress acknowledge received.
FROM : 003456789 ID IN DIST : 123456789 KIND : DISTRESS ACK NATURE : UNDESIGNATED POS : 12° 34. 1234' N 123° 45. 6789' E AT : 12 : 34 TELEPHONE ACK
CANCEL ALARM

3. Press the **CANCEL** key.
4. Press the **ENT** key. The standby display with CH16 appears.
5. Provide the following information to the coast station, using a handset:

Distress communication

- (1) Press the PTT switch and speak slowly and distinctly, "MAYDAY, MAYDAY, MAYDAY," pronounced as the French expression "m'aider."
- (2) This is; "the name of your vessel and call sign" three times.
- (3) "MAYDAY"
- (4) This is; "the name of your vessel and call sign."
- (5) Position in latitude and longitude;
- (6) The nature of the distress;
- (7) The kind of assistance desired;
- (8) Number of persons on board;
- (9) Any other information which might facilitate rescue, for example, length, color, and type of vessel.
- (10) Indicate the end of message by saying "Over."

CANCELING DISTRESS ALERT

If you have transmitted a false distress alert, cancel it immediately as follows.

1. Press the **CANCEL** key to show the following window.

Distress call will be cancelled? YES NO

2. Select YES by rotating the **CHANNEL** knob and press the **ENT** key.

CAUTION !
Cancel DISTRESS on CH16 by VOICE. EXT:ENT

3. Press the **ENT** key to acknowledge the CAUTION message.
The channel changes to 16.
4. Transmit message to "All Stations" giving your vessel's name, call sign and DSC number.

Example message

All Stations, All Stations, All Stations
This is VESSEL'S NAME, CALLSIGN,
DSC NUMBER, POSITION.

Cancel my distress alert of DATE, TIME, UTC.
Master, VESSEL'S NAME, CALLSIGN.
DSC NUMBER, DATE, TIME UTC.

TABLE OF CONTENTS

FOREWORD	viii
-----------------------	-------------

SYSTEM CONFIGURATION	x
-----------------------------------	----------

1. OPERATIONAL OVERVIEW

1.1 Controls Keys and LCD Indication	1-1
1.1.1 Front panel.....	1-1
1.1.2 Controls	1-2
1.1.3 Indications on the LCD	1-5
1.1.4 Audio alarms.....	1-7
1.2 VHF Basic Operation.....	1-8
1.2.1 Turning the power on and adjusting dimmer.....	1-8
1.2.2 Selecting channel modes, channels	1-8
1.2.3 Adjusting volume of loudspeaker	1-8
1.2.4 Adjusting squelch.....	1-9
1.2.5 Transmitting	1-9
1.2.6 Selecting output power	1-9
1.2.7 Turning the loudspeaker on/off	1-9
1.2.8 Quick selection of CH16	1-10
1.2.9 Dual watch.....	1-10
1.2.10 Scanning.....	1-10
1.2.11 Remarks on voice communications	1-11
1.3 DSC Operational Overview	1-11
1.3.1 LED warnings	1-11
1.3.2 DSC operational overview	1-12
1.3.3 Automatic acknowledge on/off.....	1-13
1.4 Priority	1-13
1.5 Adjusting the Contrast.....	1-14

2. DSC DISTRESS COMMUNICATION

2.1 Distress Alert Transmission from the DISTRESS Key	2-1
2.2 Distress Alert Transmission with Nature of Distress.....	2-4
2.3 Distress Alert Transmission starting with CALL Key	2-5
2.4 Canceling a False Distress Alert.	2-7
2.5 Receiving Distress Alert from Other Vessel, Transmitting DIST ACK Signal	2-8
2.6 Sending Distress Relay on Behalf of a Ship in Distress.	2-12
2.6.1 Sending distress relay to coast station	2-13
2.6.2 Sending distress relay to all ships	2-15
2.7 Receiving Distress Relay	2-17
2.7.1 Receiving distress relay all call.....	2-17
2.7.2 Receiving distress relay from coast station.....	2-18
2.7.3. Receiving distress relay area call	2-19
2.7.4 Receiving duplicated distress relay call and/or distress relay area call	2-20

3. DSC OPERATION FOR NON-DISTRESS CASES

3.1 Coast or Ship Call 3-1

 3.1.1 Sending a coast or ship call 3-2

 3.1.2 Receiving acknowledgement of coast or ship call 3-4

 3.1.3 Receiving a coast or ship call..... 3-5

3.2 Group Call.....3-10

 3.2.1 Sending a group call3-10

 3.2.2 Receiving a group call.....3-12

3.3 PSTN Call3-13

 3.3.1 Sending a PSTN call.....3-13

 3.3.2 PSTN call disconnection (ship disconnects line)3-14

 3.3.3 PSTN call disconnection (coast station disconnects line).....3-15

 3.3.4 Receiving a PSTN call3-15

3.4 ALL Ships Call.....3-16

 3.4.1 Sending an all ships call.....3-16

 3.4.2 Receiving an all ships call.3-18

3.5 Position Call3-19

 3.5.1 Position call: requesting other ship’s position3-19

 3.5.2 Position call: other ship requests your position.....3-21

3.6 Receiving a Polling Call.....3-22

 3.6.1 Automatic reply3-22

 3.6.2 Manual reply3-23

3.7 Neutral Craft Call.....3-24

 3.7.1 Sending a neutral craft call.....3-24

 3.7.2 Receiving a neutral craft call3-25

3.8 Medical Transport Call3-26

 3.8.1 Sending a medical transport call3-26

 3.8.2 Receiving a medical transport call.....3-27

3.9 Log File3-28

4. BASIC SETUP

4.1 Alarm Setup 4-1

4.2 Auto ACK Setup 4-3

4.3 Erasing Logs 4-5

4.4 Memory Channel Setup..... 4-6

4.5 Message File Entry..... 4-7

4.6 Position Setup4-11

4.7 Print Out Setup.....4-12

4.8 Volume Setup.....4-13

4.9 Special Call Setup.....4-15

4.10 RTC Setup4-15

4.11 AUTO CH Setup.....4-16

4.12 PROPOSE CH Setup4-16

4.13 AUTO REVERT Setup4-17

5. SYSTEM SETUP

5.1 Displaying Self ID 5-1
 5.2 Displaying Group ID List 5-1
 5.3 Naming Intercom 5-2
 5.4 Displaying Program Version 5-3

6. MAINTENANCE & TROUBLESHOOTING

6.1 Maintenance 6-1
 6.2 Troubleshooting 6-1
 6.3 Daily Test 6-2
 6.4 DSC Test Transmission 6-3
 6.4.1 Transmitting a DSC test message 6-3
 6.4.2 Receiving a test message 6-5
 6.5 Error Message 6-6
 6.6 Parts Location 6-6

APPENDIX AP-1

Menu Tree AP-1
 Marine VHF Channel Lists AP-3
 Digital Interface (IEC 61162-1 Edition 2) AP-14
 Thermal Printer UTP-80FK AP-19

INDEX IN-1

Declaration of Conformity

FOREWORD

A Word to FM-8800D/8800S Owners

Congratulations on your choice of the FURUNO FM-8800D/8800S VHF Radiotelephone. We are confident you will see why the FURUNO name has become synonymous with quality and reliability.

For over 60 years FURUNO Electric Company has enjoyed an enviable reputation for quality marine electronics equipment. This dedication to excellence is furthered by our extensive global network of agents and dealers.

This equipment is designed and constructed to meet the rigorous demands of the marine environment. However, no machine can perform its intended function unless operated and maintained properly. Please carefully read and follow the recommended procedures for operation and maintenance.

We would appreciate hearing from you, the end-user, about whether we are achieving our purposes.

Thank you for considering and purchasing FURUNO equipment.

Features

The FURUNO FM-8800D/8800S is a cost-effective all-in-one marine VHF radio system consisting of a 25 W VHF radiotelephone, a DSC modem, and a CH 70 watch receiver. It complies with GMDSS carriage requirements for safety and general communications.

The FM-8800D offers full-duplex voice communications and the FM-8800S offers simplex voice communication on ITU channels in the marine mobile VHF band. The features include Dual Watch which allows a continuous watch on CH16 and another selected frequency.

Full Class-A DSC functions are provided for distress alert transmission and reception, as well as the general call formats (Individual telephone, All Ships, and Group call). Distress alert can be readily transmitted but an arrangement is provided to prevent accidental activation. The FM-8800D/8800S maintains a continuous watch on CH70 even while another VHF channel is in use. Aural and visual alarms are given to incoming DSC messages.

The main features of the FM-8800D/8800S are

- Compact cabinet allows for flexible and space-saving installation on a navigation console or at the conning position
- Conforms to the following standards and regulations:
 IMO A.385 (X), A.524 (13), A.694 (17), A.803 (19)
 IMO MSC 68 (68) A1/A2/A3/A4, MSC/Cir.682
 ITU-R M.489-2, M.493-11, M.541-9, M.689-2, M.821-1
 IEC60945 (Ed.4), 61162-1 (July 2000)
 EN300 338 (V1.2.1), 300 828 (V1.1.1), 300 698-1 (V1.3.1)
 EN301 033 (V1.2.1), 301 925 (V1.2.1)
- Precision PLL frequency synthesizer for high frequency stability as required for DSC operation
- Dual Watch and Multiple Watch
- Continuous DSC watch on CH70
- Prevention of accidental distress alert
- File editing for emergency readiness
- Automatic entry of own ship position with manual override

Program number

FM-8800D/8800S:	0550215-04
HS-8800/HS-8800W:	0550216-01
IF-8820:	0550217-01

SYSTEM CONFIGURATION

The FM-8800D/8800S is a highly advanced 25 W VHF transceiver with DSC terminal. It is designed to satisfy the stringent requirements of marine communications, and complies with GMDSS carriage requirements for safety and general communications.

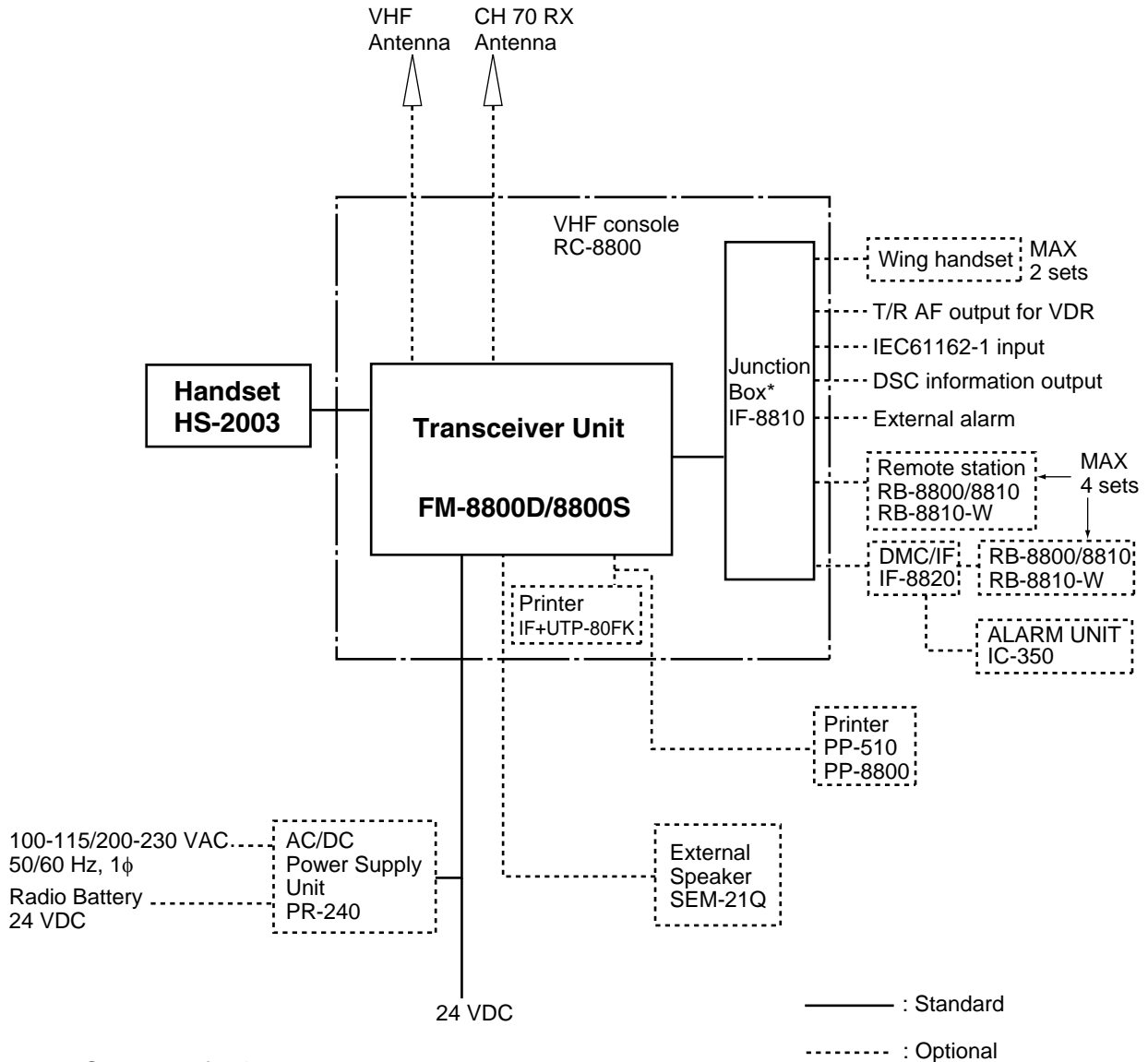

Category of units

Unit	Category
Antenna	Exposed to weather
All other units	Protected from weather

*: Option for FM-8800D/S-N

FM-8800D/8800S system configuration

1. OPERATIONAL OVERVIEW

The FM-8800D/8800S system consists of a transceiver block and two antennas. The transceiver block contains a VHF transmitter, receiver, and channel 70 watch receiver module. All operations are controlled on its front panel.

1.1 Controls Keys and LCD Indication

1.1.1 Front panel

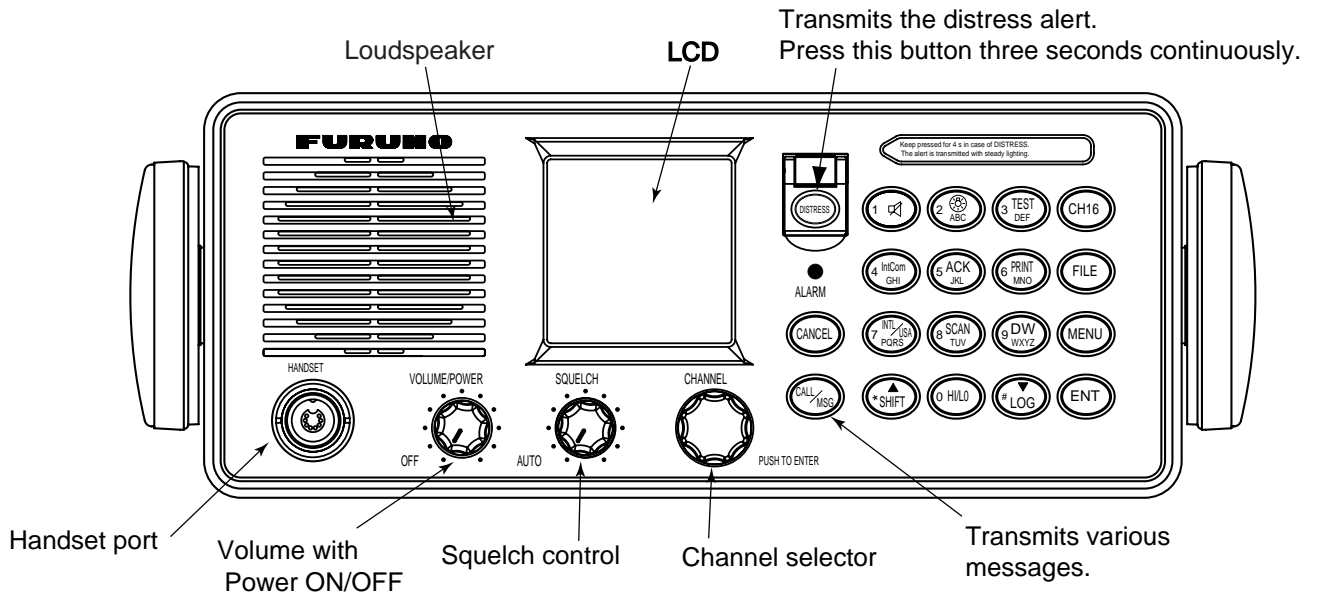

Transceiver unit

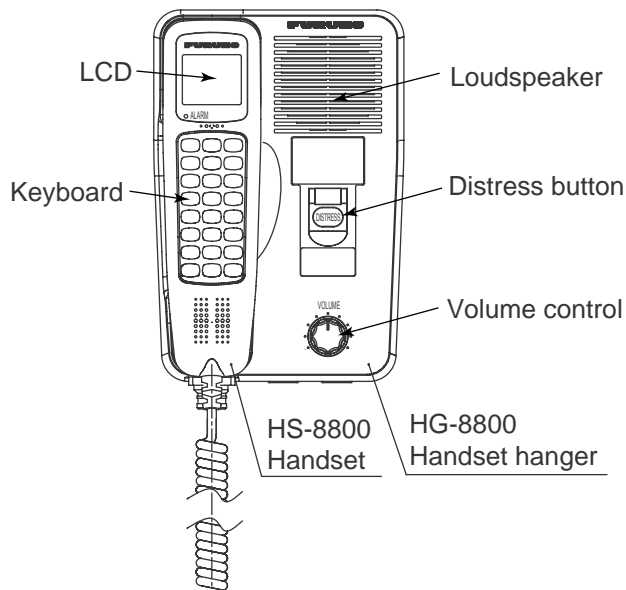



Remote station (option)

1.1.2 Controls

The functions of keys of the transceiver unit and the remote station are almost the same. The table below shows the controls and keys for the transceiver unit.

Controls	Functions
CHANNEL (PUSH TO ENTER)	<ul style="list-style-type: none"> • Selects a channel. • Moves the cursor at menu opened. • Registers a selected item when pressed.
SQUELCH	<ul style="list-style-type: none"> • Mutes the receiver when no signal is presented on the channel selected. • AUTO position automatically reduces white noise.
VOLUME/POWER	<ul style="list-style-type: none"> • Turns the power on/off and adjusts the volume of the loudspeaker.
KEY	Functions
DISTRESS	<ul style="list-style-type: none"> • Transmits the distress alert after pressing four seconds. <p>When the key is pressed, the LED brinks and the buzzer sounds. Pressing the key four seconds continuously the distress alert is transmitted and the LED lights continuously and the buzzer sounds three seconds.</p> <p>These conditions are continued until the distress acknowledge is received or you cancel the distress alert.</p>
ALARM (INDICATOR)	<ul style="list-style-type: none"> • Blinks in red when a distress alert or urgent call is received. Also, the acoustic alarm sounds. To stop the blinking and silence buzzer, press the CANCEL key. • Blinks in green when a safety call or routine call is received. The acoustic alarm sounds and stops automatically two minutes later.
CANCEL	<ul style="list-style-type: none"> • Stops audible and visual alarms. • Erases an error message. • Cancels numeric entry. • Returns a previous menu. • Cancels transmission or printing • Cancels the distress mode by pressing more than four seconds. • Cancels the dual watch. • Cancels the scanning.
CALL MSG	<ul style="list-style-type: none"> • Transmits various DSC messages. To transmit a DSC message, press this key more than three seconds.

<p style="text-align: center;">1</p> 	<ul style="list-style-type: none"> • Enters 1, ., ,, ', " , : , ; , - , + , * , # , , (,) , ! , \$, & , / character at entry mode. • Turns the loudspeaker on or off when proceeded by the SHIFT key. <p>In the off state, the loudspeaker icon appears. However, the key click activates and the alarm sounds when a distress call, urgent call, distress receive, or urgent receiver is activated.</p>
<p style="text-align: center;">2</p>  <p style="text-align: center;">ABC</p>	<ul style="list-style-type: none"> • Enters alphanumeric data (2, A, B, C, a, b, c). • Adjusts panel illumination when proceeded by the SHIFT key.
<p style="text-align: center;">3</p> <p style="text-align: center;">TEST</p> <p style="text-align: center;">DEF</p>	<ul style="list-style-type: none"> • Enters alphanumeric data (3, D, E, F, d, e, f). • Performs the daily test when proceeded by the SHIFT key.
<p style="text-align: center;">4</p> <p style="text-align: center;">IntCom</p> <p style="text-align: center;">GHI</p>	<ul style="list-style-type: none"> • Enters alphanumeric data (4, G, H, I, g, h, i). • Turns the interphone on when proceeded by the SHIFT key and followed by ENT key. Available when a remote handset is connected.
<p style="text-align: center;">5</p> <p style="text-align: center;">ACK</p> <p style="text-align: center;">JKL</p>	<ul style="list-style-type: none"> • Enters alphanumeric data (5, J, K, L, j, k, l). • Turns auto acknowledge of routine calls on or off when proceeded by the SHIFT key.
<p style="text-align: center;">6</p> <p style="text-align: center;">PRINT</p> <p style="text-align: center;">MNO</p>	<ul style="list-style-type: none"> • Enters alphanumeric data (6, M, N, O, m, n, o). • Prints communication log files, current display and daily test result.
<p style="text-align: center;">7</p> <p style="text-align: center;">INT/USA</p> <p style="text-align: center;">PQRS</p>	<ul style="list-style-type: none"> • Enters alphanumeric data (7, P, Q, R, S, p, q, r, s). • Changes the channel mode among INTL, USA**, WX**, CANADA**, INLND-W** and (PRIV/MEMO)*. <p>*: If registered.</p> <p>** : Required system setting by qualified serviceman only.</p>
<p style="text-align: center;">8</p> <p style="text-align: center;">SCAN</p> <p style="text-align: center;">TUV</p>	<ul style="list-style-type: none"> • Enters alphanumeric data (8, T, U, V, t, u, v). • Turns the scan function on when proceeded by the SHIFT key.
<p style="text-align: center;">9</p> <p style="text-align: center;">DW</p> <p style="text-align: center;">WXYZ</p>	<ul style="list-style-type: none"> • Enters alphanumeric data (9, W, X, Y, Z, w, x, y, z). • Turns the dual watch function on when proceeded by the SHIFT key.

1. OPERATIONAL OVERVIEW

<p>0 HI/LO</p>	<ul style="list-style-type: none"> • Enters "0". • Changes the output power high (25 W) or low (1 W) when proceeded by the SHIFT key. However, the following channels are always 1 W. INTL mode: CH15, CH17, CH75, CH76 USA mode: CH13, CH17, CH67, CH77 CANADA mode: CH15, CH17, CH20, CH65, CH77
<p>▲ * SHIFT</p>	<ul style="list-style-type: none"> • Press to activate secondary function. • Moves the screen to previous item. • Moves cursor backward for editor field.
<p>▼ LOG #</p>	<ul style="list-style-type: none"> • Displays transmitting/receiving messages. • Moves the screen to next item. • Moves cursor forward for editor field.
CH16	<ul style="list-style-type: none"> • Selects CH16 by one-touch action.
FILE	<ul style="list-style-type: none"> • Opens the Message file list.
MENU	<ul style="list-style-type: none"> • Opens the SETUP menu.
ENT	<ul style="list-style-type: none"> • Registers the input. (Same as pressing the CH selector.)

Additional keys of the handset HS-8800/HS-8000-W

Key	Function
<p>▲ (up arrow key)</p>	<ul style="list-style-type: none"> • With the SHIFT key pressed, this key increases volumes of internal loudspeaker of remote station. • Scrolls the screen up or increments setting value.
<p>SQ ◀</p>	<ul style="list-style-type: none"> • Adjusts squelch level. • With the SHIFT key pressed, turns off the auto squelch.
<p>▼ (down arrow key)</p>	<ul style="list-style-type: none"> • With the SHIFT key pressed, this key decreases volumes for internal loudspeaker of remote station. • Scrolls the screen down or decrements setting value.
<p>SQ auto ▶</p>	<ul style="list-style-type: none"> • Adjusts squelch level. • With the SHIFT key pressed, turns on the auto squelch.
<p>2 ⊕ ABC</p>	<ul style="list-style-type: none"> • Increases number at the memory channel or private channel setting.
<p>8 SCAN TUV</p>	<ul style="list-style-type: none"> • Decreases number at the memory channel or private channel setting.

1.1.3 Indications on the LCD

Below are all the indications which appear on the standby display on the transceiver unit.

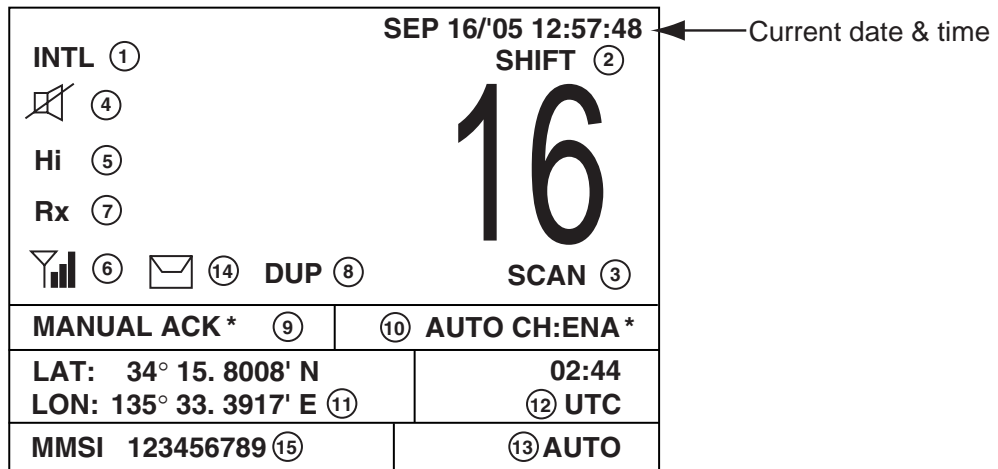

Standby display on the transceiver unit

Reference no.	Meaning
1	Displays the channel mode. (INTL / USA / WX / CANADA / INLAND-W / PRIV / (MEMO))
2	SHIFT is displayed if the shift function is active. Or channel mode (for example CANADA) is displayed at the MEMO mode.
3	Displays the scan mode: SCAN, DW16 or no display. During the scan mode, channel indications are changed alternatively. No display means that the unit receives continuously on the same channel.
4	Lights when the loudspeaker is off. Goes off when the loudspeaker is on.
5	Displays the transmission output. (Hi=25W / Lo=1W)
6	Displays reception signal strength by 4 steps. 1. No signal. Only antenna mark is displayed. 2. Less than 20 dB SINAD : antenna mark and short bar 3. 20 - 40 dB SINAD : antenna mark and two bars 4. 40 dB SINAD and more : antenna mark and three bars
7	RX is displayed during reception and TX is displayed when the RF signal detected at transmission state.
8	Displays the current channel. (PRIV channel: max three digits)
9	Is displayed when the DSC routine call is received. AUTO ACK: Automatic acknowledge MANUAL ACK: Manual acknowledge
10	Automatic channel setup for reception of the coast call and ship call may be set to enable (AUTO CH: ENA) or disable (AUTO CH: DIS). If no MMSI is registered, the message "DSC NOT USABLE" appears at location 9 and 10.
11	Displays the longitude and latitude of own ship.
12	Displays position fixing (above position) UTC time.
13	Displays AUTO for automatic data input (L/L, time data) from a navigation device or MANUAL for manual data input or NO DAT if no data input more than 10 seconds.
14	Displays when un-read message(s) exist.
15	Shows own ships MMSI (Maritime Mobile Service Identifier).

*: "DISTRESS MODE" is displayed at distress calling.

1. OPERATIONAL OVERVIEW

Below are the indications which appear on the standby display on the remote handset.

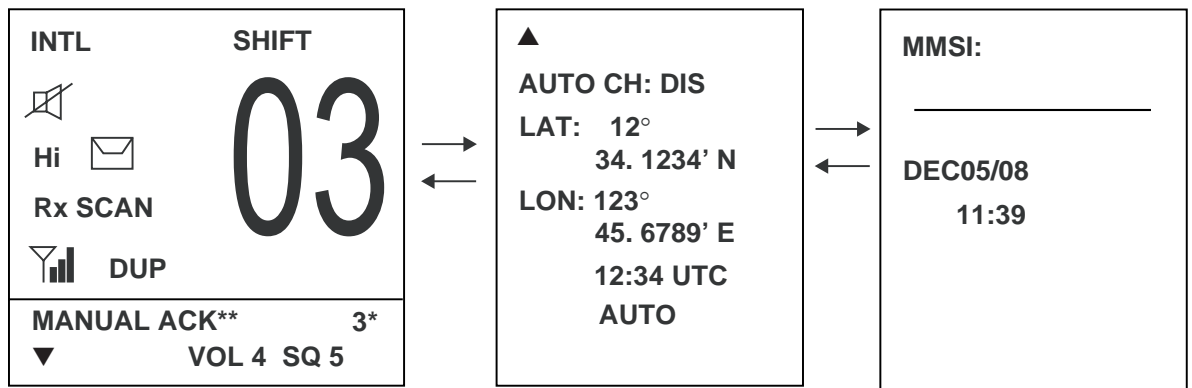

If you press  at the left-hand screen, right-hand screen appears.

If you press  at the right-hand screen, the left-hand screen appears immediately.

The indications are the same as those on of the transceiver unit.

The *- marked number is the terminal number of the remote station.

** : If no MMSI is registered, the message "DSC UNAVAIL" appears instead of MANUAL ACK. "DISTRESS MODE" is displayed at distress calling.

Note: The screen of the remote handset is smaller than the one of the transceiver unit. In this manual, display examples are from the transceiver unit. In the remote handset, scrolling with up or down arrow key displays same information as the screen of the transceiver unit.

Remote handset does not have a channel knob, but the transceiver unit does. To set private channel or memory channel at the remote station, use [2] key or [8] key.

1.1.4 Audio alarms

When you receive a distress alert or other DSC call, the audible and visual alarms are released. For the distress or urgency call, the audio alarm sounds until the **CANCEL** key is pressed. For all other calls, the audible alarm sounds for two minutes and automatically goes off. The tone of the alarm changes with the call received. By becoming accustomed to the tone, you can know which type of call you have received.

Alarm	Frequency (interval)
Safety call received Routine call received Message received from terrestrial telephone line Routine ack received Safety ack received	750 Hz (50 ms) and 650 Hz (50 ms) 10 times, Silence (2 S)
While DISTRESS key is pressed for four seconds	2000 Hz (500 ms), silence (500 ms)
DISTRESS alert sent	2200 Hz, continuous
Own ship position not updated	2000 Hz (250 ms), silence (500 ms)
DISTRESS alert received DISTRESS Relay call received	2200 Hz (250 ms), 1300 Hz (250 ms)
Urgency call received	2200 Hz (250 ms), silence (250 ms)
DISTRESS ack received DISTRESS Relay ack received	2200 Hz (500 ms), 1300 Hz (500 ms)
Urgency ack received	2200 Hz (500 ms), silence (500 ms)

When you call another handset terminal, or you are called by other handset terminal, the following audible alarm is released.

Alarm	Frequency (interval)
Intercomm alarm	800 Hz (50 ms) and 1000 Hz (50 ms) 3 times, Silence (400 ms) 800 Hz (50 ms) and 1000 Hz (50 ms) 3 times, Silence (2 S)

1.2 VHF Basic Operation

1.2.1 Turning the power on and adjusting dimmer

To turn the power on, turn the VOLUME/POWER control clockwise until you hear a click.

To adjust the dimmer of the display, press the **SHIFT** key and press [2] key several times to set a suitable dimmer. The DIMMER LEVEL box appears to show the setting level. The dimmer changes 0 (minimum) to 9 (maximum).

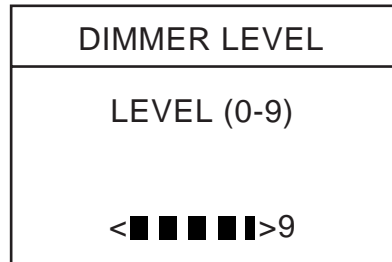

1.2.2 Selecting channel modes, channels

Selecting channel modes

To change the channel mode, press the **SHIFT** key immediately followed by the **7 INT/USA** key. Repeat this operation. The following modes are available.

- INTL : International mode
- USA : USA mode
- WX : Weather channel mode
- CANADA : CANADA mode
- INLND-W : Rhine river mode (USED ON INLAND Waterways)
- PRIV : Private channel
- MEMO : Memory channel mode if registered

Note: Private channels are available only where permitted by the authorities.
The USA, WX, CANADA, INLND-W, PRIV can also be set by a qualified serviceman.

Selecting channels

Rotate the CH selector clockwise (counterclockwise) to display desired channel. Use [2] key or [8] key at the remote station to set private channel or memory channel.

1.2.3 Adjusting volume of loudspeaker

The VOLUME control adjusts the volume of the loudspeaker.

1.2.4 Adjusting squelch

The **SQUELCH** control adjusts the squelch threshold level. Adjust it so that white noise heard in the loudspeaker just fades out. Perform this operation when no traffic is being received. AUTO squelch automatically reduces white noise. Usually select the AUTO position. Avoid turning the squelch too far clockwise — you may miss a long distance communication.

Note: To obtain correct scan watch/dual watch response, adjust the **SQUELCH** control precisely.

1.2.5 Transmitting

Press the PTT (Push-to-talk) switch on the handset or microphone to talk, and release it to listen for the response. The VHF section keyboard accepts no key input when the PTT switch is operated.

Remarks on transmitting

- Before transmitting, think about the subjects which have to be communicated and, if necessary, prepare written notes to avoid unnecessary interruptions and ensure that no valuable time is wasted on a busy channel.
- Listen before commencing to transmit to make certain that the channel is not already in use.

1.2.6 Selecting output power

After pressing the **SHIFT** key, each press of the **0 HI/LO** key selects high or low output power. Also Hi or Lo appears on the screen depending on your selection.

The transmitter power is automatically set for low on the following channels:

International: CH15, CH17, CH75, CH76

USA: CH13, CH17, CH67, CH77; to operate USA channel 13 or 67 in high power, keep **HI/LOW** key pressed while talking into the handset.

1.2.7 Turning the loudspeaker on/off

To turn the loudspeaker on/off, press the **SHIFT** key, then the **1** key. See section 4.8 to set loudspeaker on or off according to handset onhook or offhook.

1.2.8 Quick selection of CH16

Press the **CH16** key to select CH16, the International Calling and Safety Channel. The use is limited to distress, safety and calling. The transmission on CH16 (156.800 MHz) should be limited to within 1 minute except for distress calling.

Avoid calling on CH16 for purposes other than distress, urgency and very brief safety communications when another calling channel is available.

Note: When you put the handset on the handset hanger, the channel changes to CH16 in the default setting. See page 4-17 for details.

1.2.9 Dual watch

The dual watch function permits watch on CH16 and another selected channel. CH16 and another channel are watched at intervals of 0.15 seconds and one second, respectively.

To start dual watch, first select the other frequency to watch and then press the **SHIFT** key and **9 DW** key in that order. When the receiver finds a signal on CH16, it locks on it and restarts dual watching after the signal on CH16 has gone. If another channel has traffic, it still continues dual watch. The speech is heard intermittently.

To stop the dual watch function, do one of following four methods.

- a) Press the CH16 key.
- b) Press the CANCEL key.
- c) If a handset is on-hook, off-hook it.
- d) If a handset is off-hook, press the PTT switch. In this case, press the PTT switch again to transmit.

Note: The dual watch function is not available for INLAND-W mode.

1.2.10 Scanning

The receiver scans all channels at intervals of 0.15 seconds in the selected channel mode in ascending channel order, watching CH16 between channels as below:

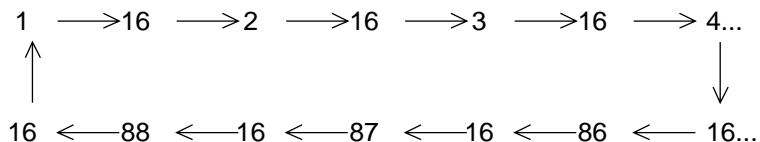

To start scanning, press the **SHIFT** and **8 SCAN** in that order. When the receiver finds a signal, scanning is stopped on that channel and starts dual watch on it and CH16.

To turn off the scanning, do one of following four methods.

- a) Press the CH16 key.
- b) Press the CANCEL key.
- c) If a handset is on-hook, off-hook it.
- d) If a handset is off-hook, press the PTT switch. In this case, press the PTT switch again to transmit.

Note: The scanning function is not available for INLAND-W mode.

1.2.11 Remarks on voice communications

Automatic acknowledge (DSC operation) is automatically changed to manual acknowledge under voice communications (off-hooked). (The “auto” indication, however, remains on the screen.) This is done to prevent a break in communications.

Automatic acknowledge is automatically restored once voice communications are terminated(on-hooked).

1.3 DSC Operational Overview

Digital Selective Calling (DSC) is the global calling system adopted by the ITU-R and IMO for selective calling of coast station and ship radio stations. The DSC system is used for both safety and routine calling. The GMDSS requires the use of DSC for distress alerting and safety calling.

1.3.1 LED warnings

The LED below the **DISTRESS** key lights continuously when the distress signal is transmitted.

The ALARM LED blinks in red (and alarm sounds) when a distress or urgent message is received. The LED can be extinguished and alarm silenced by pressing the **CANCEL** key.

The ALARM LED blinks in green (and alarm sounds) when a message other than distress or urgent is received. Alarm is automatically silenced two minutes after message is received.

1.3.2 DSC operational overview

Standby display

When the FM-8800D/8800S is turned on, the following display appears. This display is known as the “standby display.” This is where you will begin most operations.

INTL		SEP 16'05 12:57:48		INTL		SHIFT	
		16				16	
Hi				Hi			
RX				RX SCAN			
		DUP					
MANUAL ACK		AUTO CH:ENA		MANUAL ACK		1	
LAT: 34° 15. 8008' N		02:44		▼ VOL 5 SQ		2	
LON: 135° 33. 3917' E		UTC					
MMSI 123456789		AUTO					

Standby display (Transceiver unit)

Standby display (Remote handset)

(Press the down arrow key of the remote handset to view rest of screen.)

If the MMSI has not been set, the message “This unit CAN’T send any DSC calls until ship’s MMSI is entered. Press any key!” appears. In this case, consult with FURUNO dealer.

If you get lost in operation you can return to the standby display by pressing the **CANCEL** key several times.

Note: In this manual, screen examples show the transceiver’s screens. To get the same information on the handset screen, press down or up arrow key.

Preparing and transmitting DSC messages

There are two methods by which you can prepare and transmit DSC messages, and they are shown below.

- Preparing message for immediate transmission
 1. Press the **CALL** key at the standby display.
 2. Select the call type.
 3. Select other party (ID) if necessary.
 4. Select the communications category.
 5. Select the communications channel.
 6. Press the **CALL** key more than three seconds.

- Transmitting a message stored in the memory

100 messages can be saved to the memory. You may open a memory-stored message and transmit it. For details, see section 4.5 Message File Entry.

Distress alert transmission and output power

When the distress alert is transmitted (by pressing the **DISTRESS** key), the output power of the FM-8800D/8800S is automatically set to maximum (25 W).

When keyboard input is prohibited

DSC-related controls cannot be operated while a DSC message is being transmitted. (These controls are inoperative about 3 seconds during a DSC distress call; 0.5 seconds for other DSC calls.)

1.3.3 Automatic acknowledge on/off

The automatic acknowledge feature of the DSC/watch receiver automatically transmits the acknowledge back (ACK BQ) signal to the sending station when an individual or polling call is received. (For polling calls, respective item on the AUTO ACK menu must be turned on to enable automatic acknowledge.) Automatic acknowledge can be turned on or off at the standby display by pressing the **SHIFT** and **5** keys in this order.

The message AUTO ACK or MANUAL ACK appears with each press of the keys.

Note 1: To give priority to own ship's communications while own ship is communicating, show MANUAL ACK by the above procedure.

Note 2: Automatic acknowledge is not possible under the following conditions:

Priority: Distress, Urgency or Safety
 Com Type: Fax, Data, No Info
 Com Freq: No Info
 Off Hook

1.4 Priority

If one or more remote stations are installed, the transceiver unit (main unit) has the highest priority. You can interrupt remote station operation at any time with the handset of the main unit. When you hook off the handset of the main unit, "OCCUPIED FM8800" (default. This may be change. See section 5.3) is indicated on all remote stations.

Each remote station has its own priority. The remote station ID (1-4) indicates its priority. The priority of the system is as follows.

DSC of main unit > Wing handset > Handset of main unit > 1 > 2 > 3 > 4

If you hook off No.4 remote station, for example, "Occupied Handset4" is displayed on other remote stations. However, you can hook off and use No.1 handset.

Note: The priority is disabled at the distress mode.

How to set priority of the remote station

1. Disconnect the plug of a remote station to turn off the remote station.
2. While pressing the **MENU** key of a remote station, connect the plug to turn on the power.

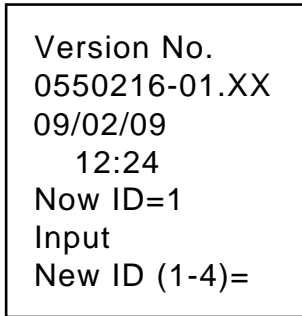

3. Press **1**, **2**, **3**, or **4** key on the remote handset as appropriate followed by the **ENT** key. Never enter same number among different remote stations.
4. Turn off and on the power of the transceiver unit.

1.5 Adjusting the Contrast

1. Press the **MENU** key to show the SETUP MENU screen.
2. Rotate the **CHANNEL** knob to show third page of the SETUP MENU and select the CONTRAST.
3. Press the **ENT** key to show the CONTRAST MENU.
4. Press the **ENT** key again to show the CONTRAST LEVEL SETUP screen.

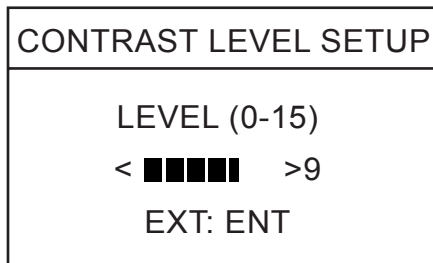

5. Rotate the **CHANNEL** knob, or press the **←** or **→** key to adjust the contrast.
6. Press the **ENT** key.

Note: To restore the default value of the contrast, press the **SHIFT** key three seconds at the standby display.

2. DSC DISTRESS COMMUNICATION

2.1 Distress Alert Transmission from the DISTRESS Key

If a distress situation occurs, do as follows:

1. Open the **DISTRESS** key cover and press the **DISTRESS** key more than four seconds. The alarm sounds and the red lamp in the key blinks. The lamp will light steadily four seconds later and at the same time the distress alert is transmitted.

The screen changes as follows.

- 1) When the **DISTRESS** key is pressed and held down,

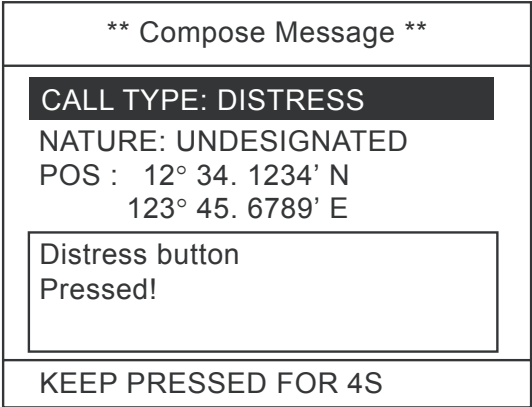

- 2) After the timer counts down to zero, "Distress Call in Progress" is announced.

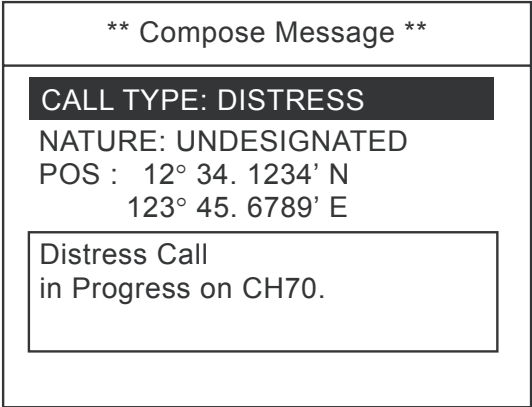

2. DSC DISTRESS COMMUNICATION

- 3) The screen changes to “distress acknowledge (DIST ACK) waiting” display. In this condition, distress communication with CH16 may be possible.

** Compose Message **
CALL TYPE: DISTRESS NATURE: UNDESIGNATED POS : 12° 34. 1234' N 123° 45. 6789' E
Waiting for distress acknowledgement. CH16 Now available.
TIME TO GO : 4M 12S

- 4) When the DIST ACK is received,

Distress acknowledge received.
FROM : 003456789 ID IN DIST : 123456789 KIND : DISTRESS ACK NATURE : UNDESIGNATED POS : 12° 34. 1234' N 123° 45. 6789' E AT : 12 : 34 TELEPHONE ACK
CANCEL ALARM

Note: If you do not receive the distress alert acknowledge call, during 3.5 to 4.5 minutes the equipment automatically re-transmits the distress alert and then awaits the distress alert acknowledge call. This is repeated until the distress alert is acknowledged.

2. Press the **CANCEL** or **ENT** key. The screen changes as follows.

** Received Message **
APR08/04 18:30 ECC : OK DISTRESS ACK FROM : 003456789 ID IN DIST : 123456789 KIND : DISTRESS ACK NATURE : UNDESIGNATED POS : 12° 34. 1234' N 123° 45. 6789' E AT : 12 : 34 TELEPHONE ACK
PRESS ENT

3. Press the **ENT** key. The standby display with CH16 and Hi appears.
4. Provide the following information to the coast station, using a handset on the transceiver unit or remote stations (if connected):

Distress communication

- (1) Press the PTT switch and speak slowly and distinctly, "MAYDAY, MAYDAY, MAYDAY," pronounced as the French expression "m'aider."
- (2) This is; "the name of your vessel and call sign" three times.
- (3) "MAYDAY"
- (4) This is; "the name of your vessel and call sign."
- (5) Position in latitude and longitude;
- (6) The nature of the distress;
- (7) The kind of assistance desired;
- (8) Number of persons on board;
- (9) Any other information which might facilitate rescue, for example, length, color, and type of vessel.
- (10) Indicate the end of message by saying "Over."

Note: Some countries do not have sea area "A1." In this case "ACK" from the coast station does not arrive over DSC. A ship nearby will contact the vessel in distress over CH16. After transmitting the distress alert, conduct voice distress communications as shown above.

How to return to the normal mode

When the DIST ACK is received, the FM-8800D/S changes to the distress mode. In this mode, the CALL, FILE and MENU keys are inoperative. After completing the distress communication and restoring to the normal state, cancel the distress mode as follows.

1. Press the **CANCEL** key three seconds to return to the normal mode.

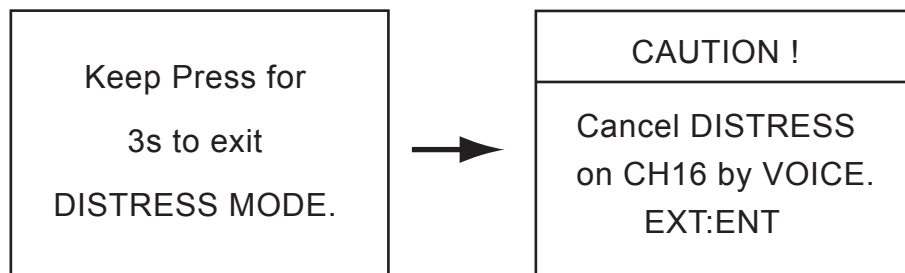

2. Press the **ENT** key.
The distress mode changes to the normal mode.

2.2 Distress Alert Transmission with Nature of Distress

If you want to transmit the distress alert with nature of distress specified, do as follows:

1. Open the **DISTRESS** key cover and press the **DISTRESS** key momentarily. The alarm sounds and the red lamp in the key blinks and after releasing the key within four seconds the alarm stops and the red lamp goes off. The following screen appears.

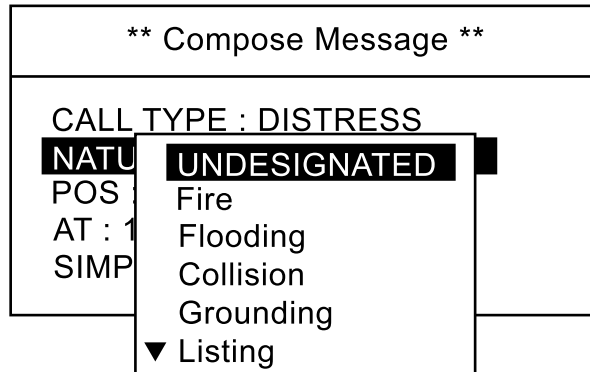

2. Rotate the channel knob to choose the nature of distress. On the remote handset, press the up or down arrow key.

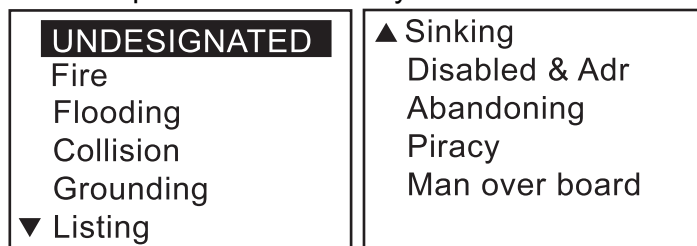

3. Press the **ENT** key. The screen changes as follows.

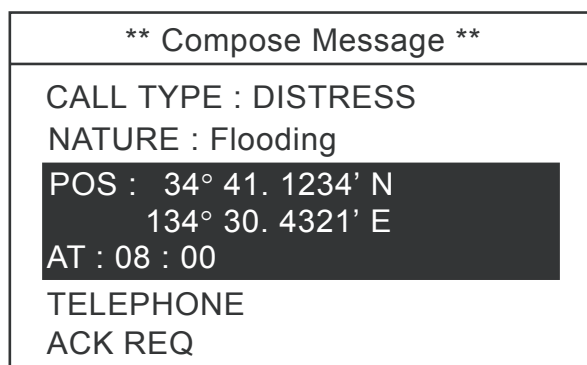

The own ship's position and current time in UTC are displayed if your FM-8800D/8800S is connected to a navigation equipment, for example, GPS.

4. Press the **DISTRESS** key more than four seconds.

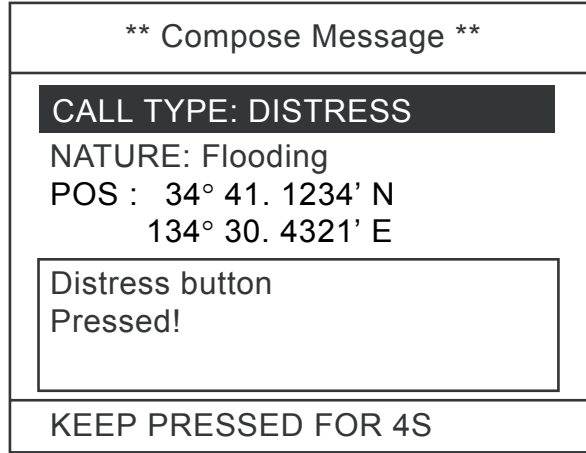

The distress alert with nature of distress, ship's position and time are transmitted.

The sequence of display and procedures are the same as in paragraph 2.1.

2.3 Distress Alert Transmission starting with CALL Key

You can compose the distress alert with nature of distress from the **CALL** key.

1. Press the **CALL** key.

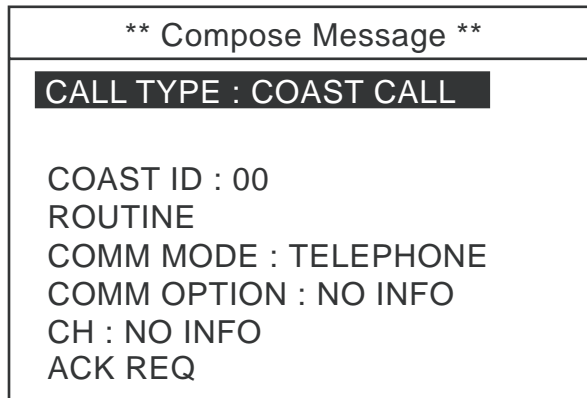

Transceiver unit screen

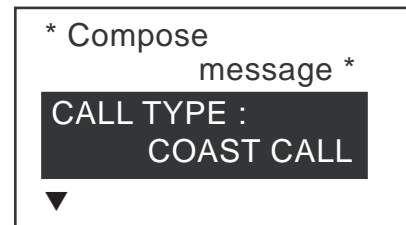

Remote handset screen

2. Press the **ENT** key to show the call type selection window.

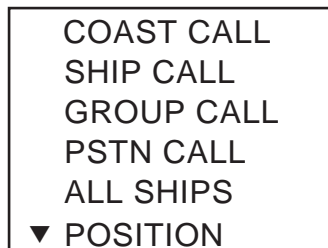

3. Rotate the **CH** knob (or press up / down arrow key) to choose DISTRESS. Press the **ENT** key.

2. DSC DISTRESS COMMUNICATION

** Compose Message **
CALL TYPE : DISTRESS NATURE : UNDESIGNATED POS : 12° 34. 1234' N 123° 45. 6789' E AT : 12 : 34 TELEPHONE ACK REQ

4. Press the **ENT** key to display the distress nature list.

UNDESIGNATED Fire Flooding Collision Grounding ▼ Listing	▲ Sinking Disabled & Adr Abandoning Piracy Man over board
--	---

5. Rotate the **CH** knob (or press up / down arrow key) to choose nature of distress and press the **ENT** key.

** Compose Message **
CALL TYPE : DISTRESS NATURE : Abandoning POS : 34° 41. 1234' N 134° 30. 4321' E AT : 08 : 00 TELEPHONE ACK REQ

6. Press the **ENT** key to show the position setup window.

INPUT TYPE : AUTO LAT : 34° 41. 1234' N LON : 134° 30. 4321' E TIME : 08 : 00

If a position fixing device is not connected, press the **ENT** key, choose **MANUAL** and enter your position.

AUTO MANUAL*

*: **MANUAL** can not be chosen if position data is input at **AUTO** mode.

7. After confirming the ship's position and time, press the **DISTRESS** key more than four seconds to transmit the distress alert.

2.4 Canceling a False Distress Alert

If you have transmitted a distress alert by mistake, do the following to cancel it.

1. Press the **CANCEL** key to show the following window.

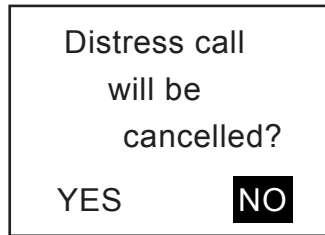

2. Select YES by rotating the **CHANNEL** knob and press the **ENT** key.

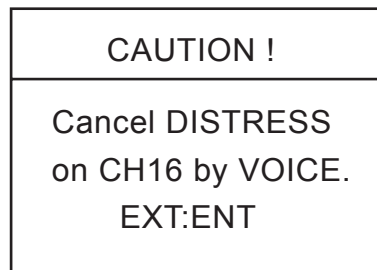

3. Press the **ENT** key to acknowledge the CAUTION message.
The channel changes to 16.
4. Transmit message to "All Stations" giving your vessel's name, call sign and DSC number.

Example message

All Stations, All Stations, All Stations
This is VESSEL'S NAME, CALLSIGN,
DSC NUMBER, POSITION.

Cancel my distress alert of DATE, TIME, UTC.
Master, VESSEL'S NAME, CALLSIGN.
DSC NUMBER, DATE, TIME UTC.

2.5 Receiving Distress Alert from Other Vessel, Transmitting DIST ACK Signal

In no case is a ship permitted to transmit a DSC distress relay call upon receipt of a DSC distress alert on VHF channel 70.

Flow chart for determining if you should/should not transmit DIST ACK signal

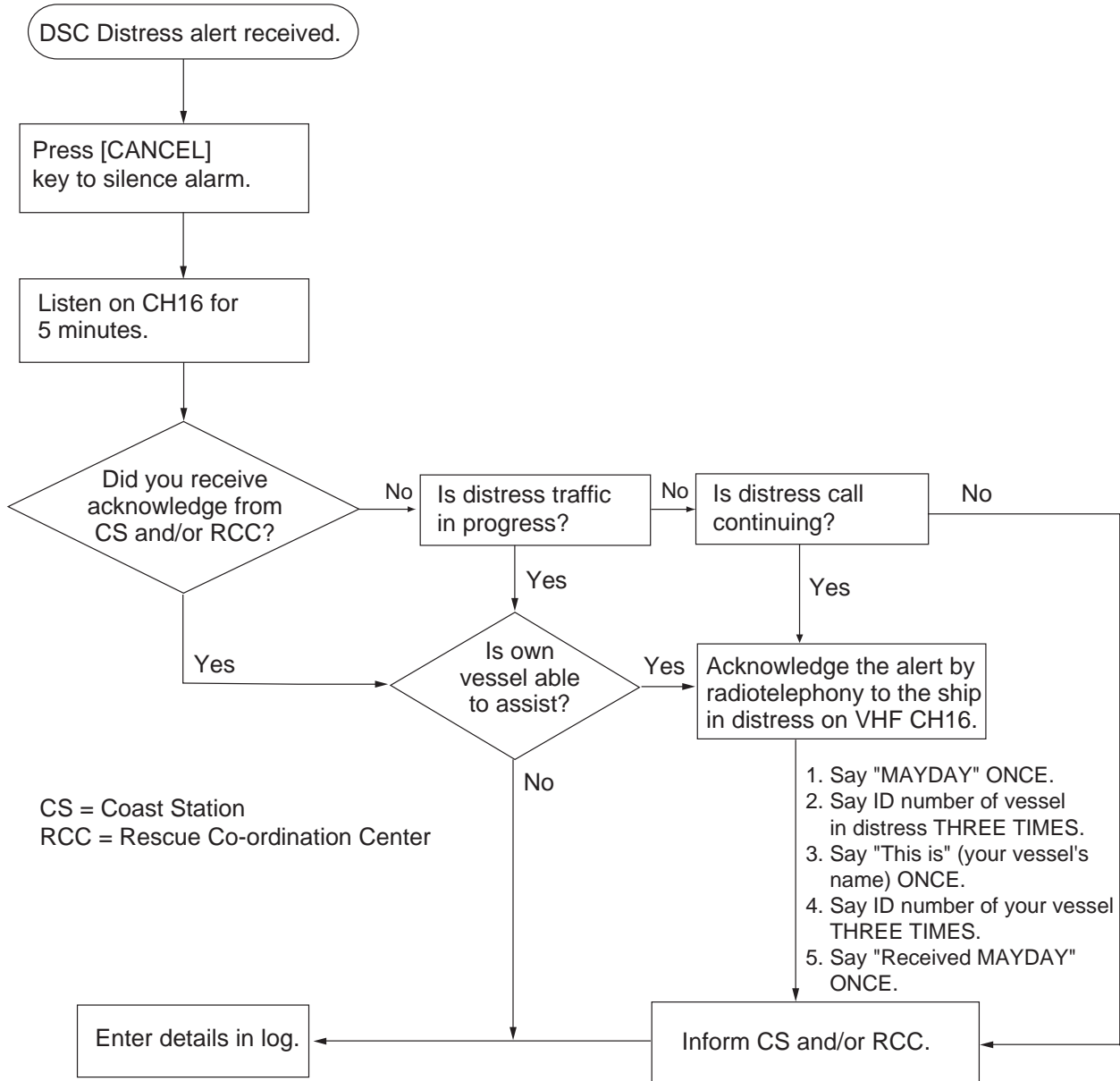

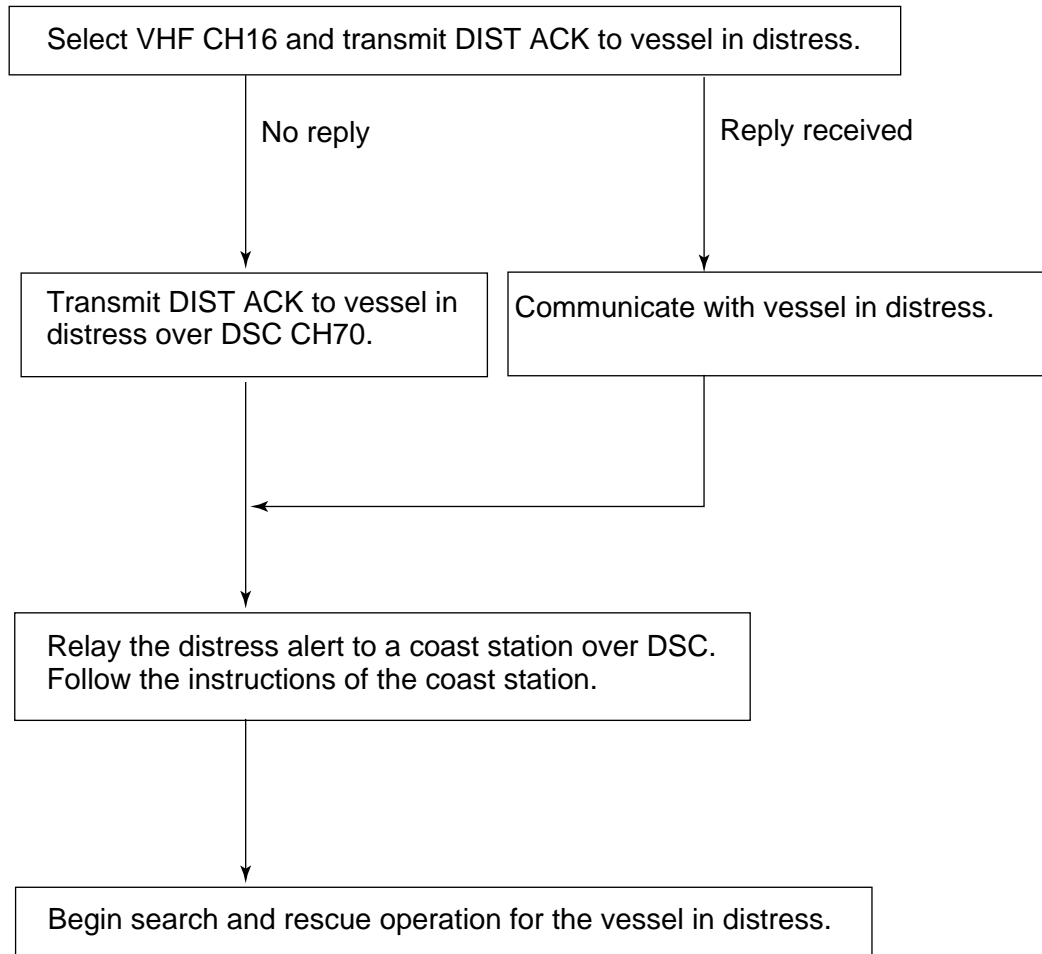
Transmitting DIST ACK over CH16**Procedure when in area A1**

1. When the FM-8800D/S receives a distress alert from another vessel, the ALARM LED (red) blinks and the FM-8800D/S sounds the distress alarm.
2. Silence the alarm by pressing the **CANCEL** key.
3. Wait up to five minutes until the DIST ACK signal from a coast station is received. Be prepared to follow the instructions of the coast station.
4. If you do not receive the DIST ACK signal, follow the flow chart shown on page 2-9 to determine if your vessel should acknowledge a distress alert.

If further DSC alerts are received from the same source and the ship in distress is beyond doubt in the vicinity, a DSC acknowledgement may, after consultation with a Rescue Co-ordination Center (RCC) or Coast Station, be sent to terminate the distress call.

Note 1: An asterisk (*) in a received distress alert message indicates error or unknown at the location marked with the asterisk. For POS field, “-“ appears when a position data has no fractional part.

Note 2: Do not send DIST ACK in response to receipt of distress alert having the nature of distress as “EPIRB emission”.

2. DSC DISTRESS COMMUNICATION

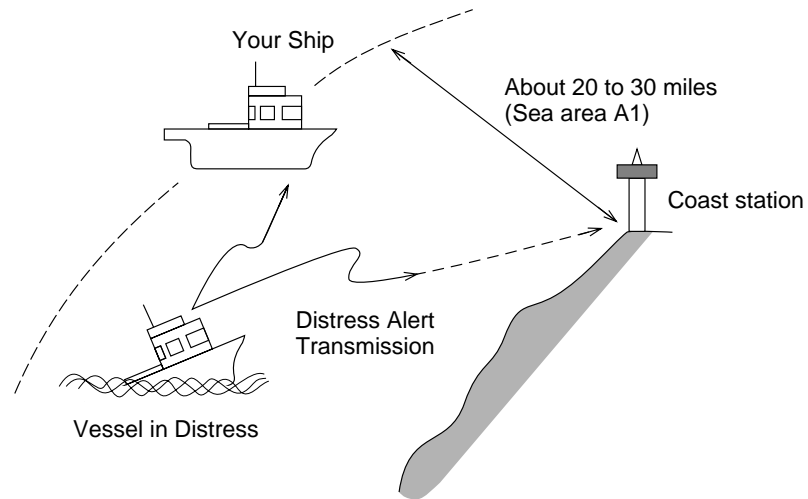

Receiving distress alert from other vessel

Transmitting DIST ACK signal

If your vessel meets the requirements necessary to transmit the DIST ACK signal, do the following:

When a distress alert from other ship is received, the following screen appears. The alarm sounds and the ALARM lamp blinks.

Distress Call received.
ID IN DIST : 123456789 NATURE : UNDESIGNATED POS : 12° 34. 1234' N 123° 45. 6789' E AT : 12 : 34 TELEPHONE ACK REQ
CANCEL ALARM

1. Press the **CANCEL** or **ENT** key to silence the alarm. The following message appears.

** Received Message **
MAY10/04 08:03 ECC : OK DISTRESS ID IN DIST : 123456789 NATURE : UNDESIGNATED POS : 12° 34. 1234' N 123° 45. 6789' E AT : 12 : 34 TELEPHONE ACK REQ
PRESS ENT TO ACK

2. Press the **ENT** key.

Wait for a coast station acknowledge.
CONTINUE RETURN

3. If you do not receive DIST ACK from coast station within five minutes and your vessel meets requirements (see previous page) for transmitting DIST ACK, select CONTINUE by the **CHANNEL** knob and press the **ENT** key. The following window appears.

RELAY SEL RELAY ALL DISTRESS ACK

Note: If you receive the DIST ACK from the coast station (or other ship) within five minutes, the message “Distress acknowledge received” appears. Press the **CANCEL** key and confirm the received message. Press the **ENT** key to return to the standby display.

2. DSC DISTRESS COMMUNICATION

4. Choose DISTRESS ACK and press the **ENT** key.

** Send Message **
DISTRESS ACK TO : 123456789 KIND : DISTRESS ACK NATURE : UNDESIGNATED POS : 12° 34. 1234' N 123° 45. 6789' E AT : 12 : 34 TELEPHONE ACK
PRESS CALL TO SEND

5. Press **CALL** key more than three seconds to transmit the DIST ACK.
After transmitting the DIST ACK, the standby display appears.

After transmitting DIST ACK

Begin search and rescue operations for the vessel in distress, communicating with the vessel over CH16 (automatically set). Relay distress alert to coast station by DSC following the instruction in the next paragraph. Finally, follow the instructions of the coast station.

2.6 Sending Distress Relay on Behalf of a Ship in Distress

When you should relay a distress alert

You may relay a distress alert in the following conditions:

- 1) When the station in distress is not itself in a position to transmit the distress message, or
- 2) When the master or person responsible for the vessel not in distress, or the person responsible for the coast station, considers that further help is necessary.

DO NOT press the **DISTRESS** key to relay a distress alert; it is for use when own vessel is in distress.

2.6.1 Sending distress relay to coast station

1. Press the **CALL** key. The [Compose message] screen appears.

** Compose Message **
CALL TYPE : COAST CALL COAST ID : 00 ROUTINE COMM MODE : TELEPHONE COMM OPTION : NO INFO CH : NO INFO ACK REQ

2. Press the **ENT** key. The CALL TYPE selection window appears.
3. Rotate the **CH** knob (or press up / down arrow key) to choose RELAY SEL.

COAST CALL SHIP CALL GROUP CALL PSTN CALL ALL SHIPS ▼ POSITION	▲ TEST RELAY ALL RELAY SEL DISTRESS
---	---

4. Press the **ENT** key.

** Compose Message **
CALL TYPE : RELAY SEL COAST ID : 00 ID IN DIST : NO INFO KIND : DISTRESS RELAY NATURE : UNDESIGNATED POS : 12° 34. 1234' N 123° 45. 6789' E AT : 12 : 34 TELEPHONE ACK REQ

5. Press the **ENT** key again. The COAST ID entry window appears.
6. Key in a coast station ID with numeric keys and press the **ENT** key.
7. Press the **ENT** key again. The ID IN DIST entry window appears.
8. Key in the ID number of ship in distress with numeric keys and press the **ENT** key. If you do not know the ID, simply press the **ENT** key without entering ID; NO INFO is displayed.
9. Press the **ENT** key and the list of distress nature appears.
10. Rotate the **CH** knob to choose a nature of distress (if known) and press the **ENT** key. If you do not know the nature of distress, choose UNDESIGNATED.

2. DSC DISTRESS COMMUNICATION

11. Press the **ENT** key again.

```
INPUT TYPE : AUTO
LAT : 12° 34. 1234' N
LON : 134° 45. 6789' E
TIME : 08 : 00
```

12. Enter position of the ship in distress, following 1), 2) or 3) below.

```
AUTO
MANUAL
NO INFO
```

- 1) **For automatic input**, press the **ENT** key twice. Go to step 13.
- 2) **For manual input**, press the **ENT** key to open the INPUT TYPE menu, rotate the **CH** knob to choose MANUAL and then push the **ENT** key.
Enter latitude and longitude of ship in distress and time as follows:
 - a) Enter latitude and then press the **ENT** key.
 - b) Enter longitude and then press the **ENT** key.
 - c) Enter UTC time and then press the **ENT** key. Go to step 13.
- 3) **If you cannot confirm position of ship in distress**, press the **ENT** key to open the INPUT TYPE menu, rotate the **CH** knob to choose NO INFO and then press the **ENT** key. Go to step 13.

13. Press the **CALL** key more than three seconds to transmit the distress relay.

```
** Compose Message **
CALL TYPE : RELAY SEL
COAST ID : 003456789
ID IN DIST : NO INFO
KIND : DISTRESS RELAY
NATURE : UNDESIGNATED
POS : 12° 34. 1234' N
      123° 45. 6789' E
AT : 12 : 34
TELEPHONE
ACK REQ
KEEP PRESSED FOR 3S
```

When CALL key is pressed, this message appears and timer counts down.

The message will be transmitted and "Waiting for acknowledgement" will appear.

2.6.2 Sending distress relay to all ships

1. Press the **CALL** key. The [Compose message] screen appears.

** Compose Message **
CALL TYPE : COAST CALL COAST ID : 00 ROUTINE COMM MODE : TELEPHONE COMM OPTION : NO INFO CH : NO INFO ACK REQ

2. Press the **ENT** key. The CALL TYPE selection window appears.
3. Rotate the **CH** knob (or press up / down arrow key) to choose RELAY ALL.

COAST CALL SHIP CALL GROUP CALL PSTN CALL ALL SHIPS ▼ POSITION	▲ TEST RELAY ALL RELAY SEL DISTRESS
---	---

4. Press the **ENT** key.

** Compose Message **
CALL TYPE : RELAY ALL ID IN DIST : NO INFO KIND : DISTRESS RELAY NATURE : UNDESIGNATED POS : 12° 34. 1234' N 123° 45. 6789' E AT : 12 : 34 TELEPHONE NO ACK REQ

5. Press the **ENT** key again. The ID IN DIST entry window appears.
6. Key in the ID number of ship in distress with numeric keys and press the **ENT** key. If you do not know the ID, simply press the **ENT** key without entering ID; NO INFO is displayed.
7. Press the **ENT** key and the list of distress nature appears.
8. Rotate the **CH** knob (or press up / down arrow key) to choose a nature of distress (if known) and press the **ENT** key. If you do not know the nature of distress, choose UNDESIGNATED.

2. DSC DISTRESS COMMUNICATION

9. Press the **ENT** key again.

INPUT TYPE : AUTO LAT : 12° 34. 1234' N LON : 134° 45. 6789' E TIME : 08 : 00

10. Enter position of the ship in distress, following 1), 2) or 3) below.

AUTO MANUAL NO INFO

- 1) **For automatic input**, press the **ENT** key twice. Go to step 11.
- 2) **For manual input**, press the **ENT** key to open the INPUT TYPE menu, rotate the **CH** knob to choose MANUAL and then push the **ENT** key. Enter latitude and longitude of ship in distress and time as follows:
 - a) Enter latitude and then press the **ENT** key.
 - b) Enter longitude and then press the **ENT** key.
 - c) Enter UTC time and then press the **ENT** key. Go to step 11.
- 3) **If you cannot confirm position of ship in distress**, press the **ENT** key to open the INPUT TYPE menu, rotate the **CH** knob to choose NO INFO and then press the **ENT** key. Go to step 11.

11. Press the **CALL** key to transmit the call.

** Compose Message **	
CALL TYPE : RELAY ALL ID IN DIST : NO INFO KIND : DISTRESS RELAY NATURE : UNDESIGNATED POS : 12° 34. 1234' N 123° 45. 6789' E AT : 12 : 34 TELEPHONE NO ACK REQ	
KEEP PRESSED FOR 3S	←

When CALL key is pressed, this message appears and timer counts down.

After the call is transmitted, the standby display appears.

2.7 Receiving Distress Relay

2.7.1 Receiving distress relay all call

If you receive a distress relay for all ships, continue monitoring CH16.

1. When a distress relay all ships call is received, the audio alarm sounds and the display looks like the one below.

Distress relay all Call received.
FROM : 123456789 ID IN DIST : 234567890 KIND : DISTRESS RELAY NATURE : UNDESIGNATED POS : 12° 34. 1234' N 123° 45. 6789' E AT : 12 : 34 TELEPHONE NO ACK REQ
CANCEL ALARM

2. Press the **CANCEL** key or **ENT** key to silence the alarm and the display changes as below.

* Received Message *
APR01/04 12 : 34 ECC : OK DIST RLY ALL CALL FROM : 123456789 ID IN DIST : 234567890 KIND : DISTRESS RELAY NATURE : UNDESIGNATED POS : 12° 34. 1234' N 123° 45. 6789' E AT : 12 : 34 TELEPHONE NO ACK REQ
PRESS ENT

3. Press the **ENT** key to return to the standby display with CH16.
4. Watch CH16.

2.7.2 Receiving distress relay from coast station

If you receive a distress relay call from a coast station, continue monitoring CH16.

1. When a distress relay call from a coast station is received, the audio alarm sounds and the display looks like the one below.

Distress relay sel call received.
FROM : 003456789 ID IN DIST : 123456789 KIND : DISTRESS RELAY NATURE : UNDESIGNATED POS : 12° 34. 1234' N 123° 45. 6789' E AT : 12 : 34 TELEPHONE ACK REQ
CANCEL ALARM

2. Press the **CANCEL** key to silence the alarm and the display changes as below.

** Received Message **
APR01/04 12 : 34 ECC : OK DIST RLY SEL CALL FROM : 003456789 ID IN DIST : 123456789 KIND : DISTRESS RELAY NATURE : UNDESIGNATED POS : 12° 34. 1234' N 123° 45. 6789' E AT : 12 : 34 TELEPHONE ACK REQ
PRESS ENT TO ACK

3. Press the **ENT** key and press the **CALL** key more than three seconds. The standby display with CH16 appears.
4. Watch CH16.

2.7.3 Receiving distress relay area call

If you receive a distress relay area call, continue monitoring CH16.

1. When a distress relay area call from a coast station is received, the audio alarm sounds and the display looks like the one below.

Distress relay area call received.
FROM : 003456789 AREA : 15°N 120°E ↓10°→10° ID IN DIST : 123456789 KIND : DISTRESS RELAY NATURE : UNDESIGNATED POS : 12° 34. 1234' N 123° 45. 6789' E AT : 12 : 34 TELEPHONE NO ACK REQ
CANCEL ALARM

2. Press the **CANCEL** key to silence the alarm and the display changes as below.

** Received Message **
APR01/04 12 : 34 ECC : OK DIST RLY AREA CALL FROM : 003456789 AREA : 15°N 120°E ↓10°→10° ID IN DIST : 123456789 KIND : DISTRESS RELAY NATURE : UNDESIGNATED POS : 12° 34. 1234' N 123° 45. 6789' E AT : 12 : 34 TELEPHONE NO ACK REQ
PRESS ENT

3. Press the **ENT** key to return to the standby display with CH16.
4. Watch CH16.

2.7.4 Receiving duplicated distress relay call and/or distress relay area call

If you receive a distress relay call and/or distress relay area call about a same vessel, twice or more within one hour, the following message appears.

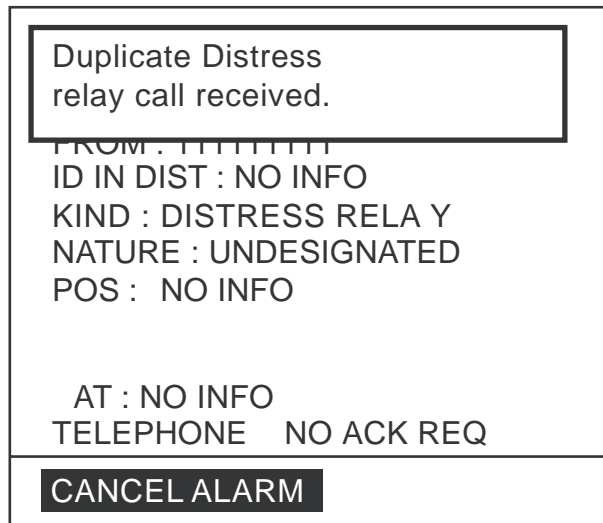

In case of distress relay call
Press the **CANCEL** key to return to the standby display.

3. DSC OPERATION FOR NON-DISTRESS CASES

Note: When you set a call type to RELAY ALL, RELAY SEL, or DISTRESS by error in the Compose Message screen, you cannot change the CALL TYPE in the same screen. If you want to cancel the call, press the CANCEL key and restart from scratch.

** Compose Message **
CALL TYPE : DISTRESS NATURE : UNDESIGNATED POS : 12° 34. 1234' N 123° 45. 6789' E AT : 12 : 34 TELEPHONE ACK REQ

3.1 Coast or Ship Call

The coast or ship call is for sending message to a specific coast or ship station. After transmitting message (called ACK RQ transmission), wait to receive the acknowledge back (ACK BQ) signal from the receiving station. You should receive it within five minutes.

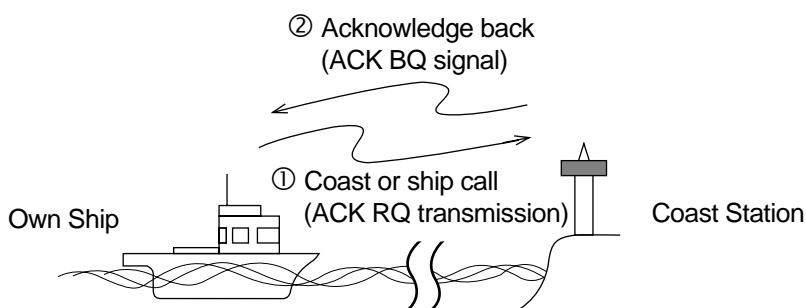

How a coast or ship call is transmitted

General procedure for transmitting a coast or ship call

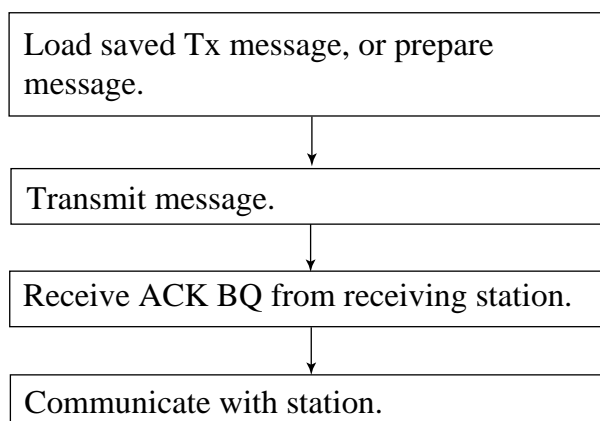

3.1.1 Sending a coast or ship call

1. Press the **CALL** key. The display changes from the standby display to the COMPOSE MESSAGE screen and the CALL TYPE is displayed in reverse video.



*1: If the coast or ship ID is registered in FILE, the registered name is displayed. If no registered, blank.

2. Press the **ENT** key to open the call type list.

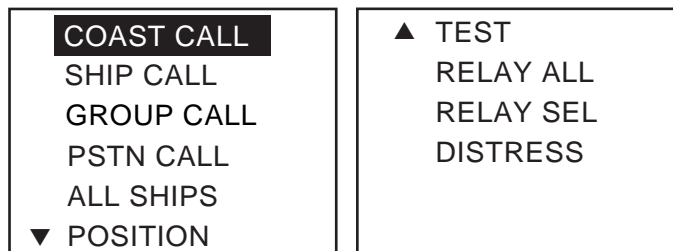

3. Rotate the **CH** knob (or press up / down arrow key) to choose COAST CALL or SHIP CALL and press the **ENT** key.
4. ID is selected; press the **ENT** key.
5. Key in a coast ID or ship ID number as appropriate and press the **ENT** key.
6. ROUTINE is selected; press the **ENT** key.



7. Choose ROUTINE, SAFETY, or URGENCY as appropriate followed by pressing the **ENT** key.

COAST CALL/ROUTINE: The COMM OPTION and CH are fixed to NO INFO. Go to step 8 to set the COMM MODE.

SHIP CALL/ROUTINE: The COMM OPTION is fixed to NO INFO. Go to step 8 to set the COMM MODE.

SAFETY: The COMM MODE and COMM OPTION are fixed to TELEPHONE and NO INFO, respectively. Go to step 10 to set the channel.

URGENCY: The COMM MODE, COMM OPTION and CH are fixed to TELEPHONE, NO INFO and 16, respectively. Go to step 13 to transmit the message.

8. COMM MODE is selected; press the **ENT** key. (for ROUTINE only)



9. Choose TELEPHONE or DATA as appropriate followed by pressing the **ENT** key. The COMM OPTION always shows NO INFO.
 For the COAST CALL/ROUTINE, go to step 13. For the SHIP CALL/ROUTINE, go to step 10.
10. Choose CH and press the **ENT** key. The following window appears.



11. Choose SELECT CH or MANUAL as appropriate followed by pressing the **ENT** key.
12. If you chose SELECT CH, the following channel list appears. Rotate the **CH** knob (or press up / down arrow key) to choose a channel you wish to communicate over and then press the **ENT** key.

CHANNEL							
01	09	17	25	64	73	81	
02	10	18	26	65	74	82	
03	11	19	27	66	75	83	
04	12	20	28	67	76	84	
05	13	21	60	68	77	85	
06	14	22	61	69	78	86	
07	15	23	62	71	79	87	
08	16	24	63	72	80	88	

(For COAST CALL/SAFETY)

SIMP CHANNEL		
06	15	73
08	16	74
09	17	75
10	67	76
11	68	77
12	69	87
13	71	88
14	72	

(For SHIP CALL/
ROUTINE and SAFETY)

If you choose MANUAL at above step, enter channel number desired with numeric keys.

13. Press the **CALL** key more than three seconds to transmit the message.

3.1.2 Receiving acknowledgement of coast or ship call

1. After a coast or ship call is sent, the equipment waits for acknowledgement of the call, showing the display below.

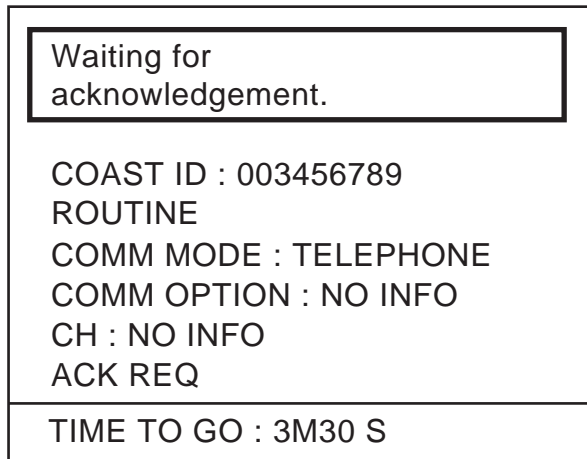

The timer starts counting down the maximum time to wait for acknowledgement, five minutes.

2. One of the following three messages appears. "No response! Try calling again?" appears after the timer counts down to zero. It means the receiving station did not respond.

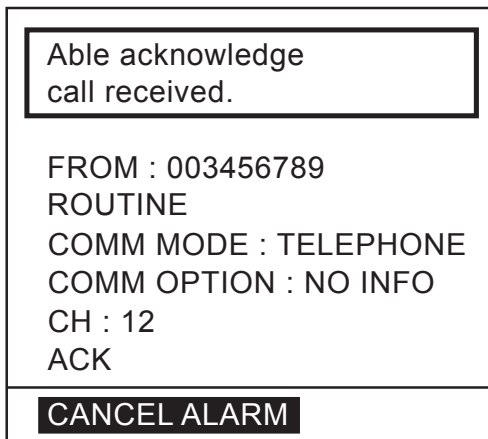

Able acknowledge call received

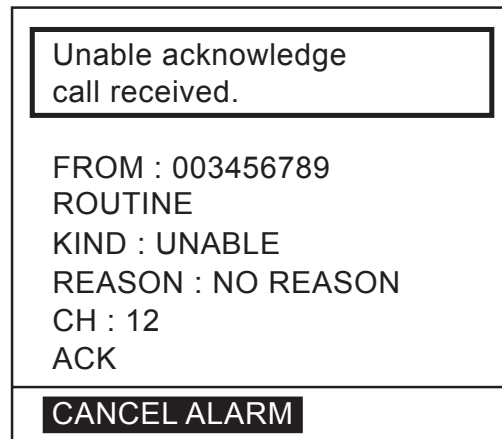

Unable acknowledge call received

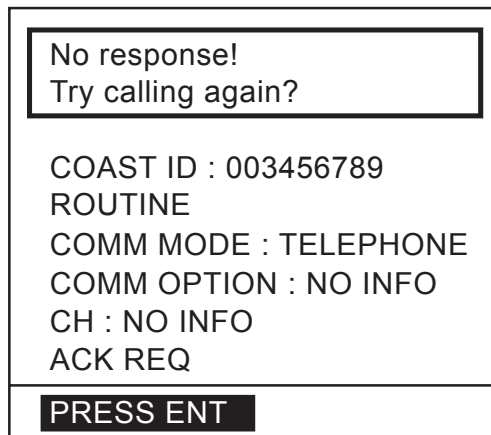

No response from station

A reason of Unable acknowledge is displayed. In case of QUEUE INDICATION, the channel will change to one that the coast station specifies.

3. Do one of the following depending on the message shown above.

Able acknowledge call received

- a) The audio alarm sounds; press the **CANCEL** key to silence it, and the display changes as below.

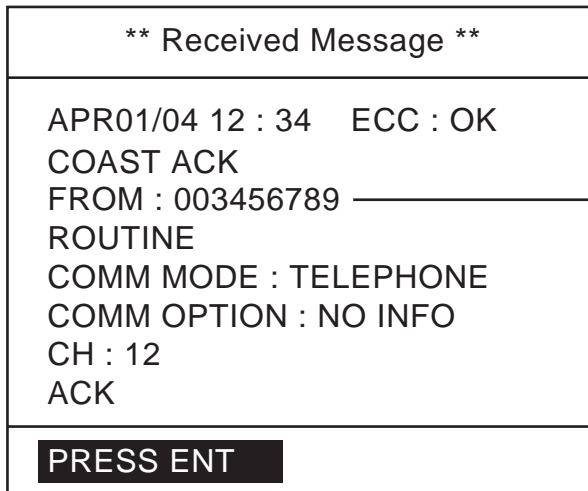

If a file is registered, its registered name is displayed instead of ID.

- b) Press the **ENT** key to go to the standby display. The working channel is automatically set; you may start voice communications.

Unable acknowledge call received

- a) The alarm sounds; press the **CANCEL** key to silence the alarm.
- b) Press the **ENT** key to return to the standby display.

No response! Try calling again?

Re-send call: Push the **ENT** key followed by pressing the **CALL** key.

Cancel call: Press the **CANCEL** key to go to the standby display.

You can re-send the message from the TRANSMITTED log. See “3.9 Log File.”

3.1.3 Receiving a coast or ship call

When own ship receives a coast or ship call, acknowledgement is automatically or manually sent depending on the comply-type setting (see paragraph 4.2). The relationship between comply status and automatic/manual acknowledge is as shown in the table below.

Comply status Setting: SHIFT→5ACK	ABLE	UNABLE
AUTO ACK	Can send ABLE acknowledge automatically.	Can send UNABLE acknowledge automatically.
MANUAL ACK	Can send ABLE acknowledge manually	Can send UNABLE acknowledge manually.

Note: The handset must be on hook to enable automatic acknowledge. Acknowledging the call automatically or manually by doing one of the following:

3. DSC OPERATION FOR NON-DISTRESS CASES

- 1) Sending automatic acknowledge (ACK BQ) with comply status "ABLE." See the procedure below.
- 2) Sending automatic acknowledge (ACK BQ) with comply status "UNABLE." See the procedure on page 3-7.
- 3) Manually acknowledging a coast or ship call with "ABLE." See the procedure on page 3-8.
- 4) Manually acknowledging a coast or ship call with "UNABLE." See the procedure on page 3-9

1) Sending automatic acknowledge (ACK BQ) with comply status "ABLE."

1. When the automatic acknowledge feature is active (AUTO ACK), the comply status is "ABLE" and a coast or ship call is received, the auto acknowledge (ACK BQ) call is sent immediately. The display shown below appears. The alarm sounds and the ALARM LED blinks two minutes.

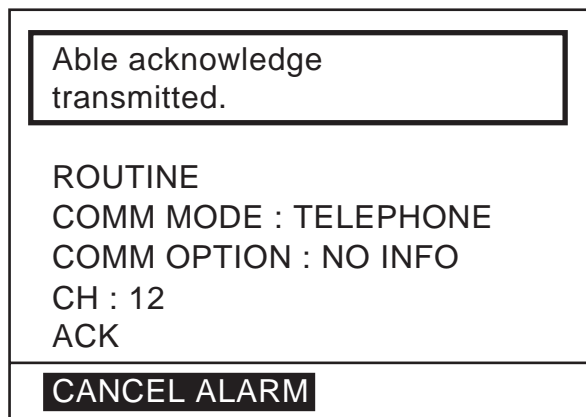

2. Press the **CANCEL** key to silence the alarm. The following display appears.

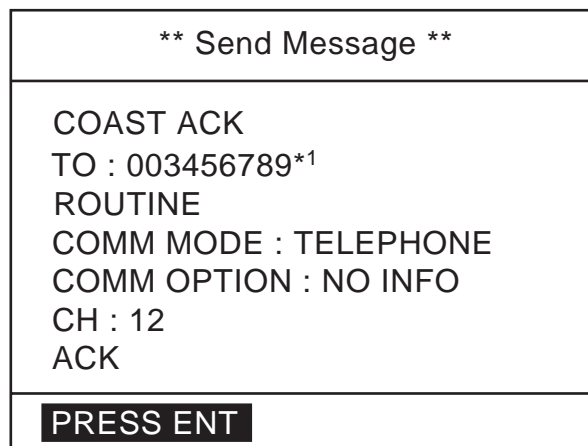

*1: If the coast or ship ID is registered in FILE, the registered name appears.

3. Press the **ENT** key. You can now communicate with the party, over the VHF channel specified.

2) Sending automatic acknowledge (ACK BQ) with comply status "UNABLE."

1. When the automatic acknowledge feature is active (AUTO ACK), the comply status is "UNABLE" and a coast or ship call is received, the display shown below appears, indicating that the auto acknowledge call with UNABLE (ACK BQ) has been sent. The alarm sounds and the ALARM LED blinks two minutes.

<div style="border: 1px solid black; padding: 2px;"> Unable acknowledge transmitted. </div> ROUTINE KIND : UNABLE REASON : BUSY CH : 12 ACK
<div style="background-color: black; color: white; padding: 2px; display: inline-block;">CANCEL ALARM</div>

2. Press the **CANCEL** key to silence the alarm. The following display appears.

** Send Message **
COAST ACK TO : 003456789 ROUTINE KIND : UNABLE REASON : BUSY CH : 12 ACK
<div style="background-color: black; color: white; padding: 2px; display: inline-block;">PRESS ENT</div>

3. Press the **ENT** key.
4. If you want to send a proposal, prepare a message and sent it following the procedures shown on in paragraph 3.1.1.

3. DSC OPERATION FOR NON-DISTRESS CASES

3) Manually acknowledging a coast or ship call with "ABLE."

1. When the equipment is set up with manual acknowledge (MANUAL ACK) and a coast or ship call is received, the alarm sounds and the display looks like the one below.

Individual request call received.
FROM : 123456789 ROUTINE COMM MODE : TELEPHONE COMM OPTION : NO INFO CH : 12 ACK REQ
CANCEL ALARM

2. Press the **CANCEL** key to silence the alarm. The following display appears.

** Received Message **
APR01/04 12 : 34 ECC : OK SHIP CALL FROM : 123456789 ROUTINE COMM MODE : TELEPHONE COMM OPTION : NO INFO CH : 12 ACK REQ
PRESS ENT TO ACK.

3. To send the ACK BQ manually, press the **ENT** key. The pop-up window shown below is displayed.

ABLE UNABLE

4. Choose **ABLE** and press the **ENT** key. The display changes as shown below.

** Send Message **
SHIP ACK TO : 123456789 ROUTINE COMM MODE : TELEPHONE COMM OPTION : NO INFO CH : 12 ACK
PRESS CALL TO SEND

5. Press the **CALL** key more than three seconds to transmit the ACK BQ. The display changes to the standby display with a channel specified.

4) Manually acknowledging a coast or ship call with "UNABLE."

1. When the equipment is set up with manual acknowledge and a coast or ship call is received, the alarm sounds and the display shows the message "Individual request call received."

Individual request call received.
FROM : 123456789 ROUTINE COMM MODE : TELEPHONE COMM OPTION : NO INFO CH : 12 ACK REQ
CANCEL ALARM

2. Press the **CANCEL** key to silence the alarm. The following display appears.

** Received Message **
APR01/04 12 : 34 ECC : OK SHIP CALL FROM : 123456789 ROUTINE COMM MODE : TELEPHONE COMM OPTION : NO INFO CH : 12 ACK REQ
PRESS ENT TO ACK.

3. DSC OPERATION FOR NON-DISTRESS CASES

3. To send the ACK BQ manually, press the **ENT** key. The pop-up window shown below is displayed.



4. Choose UNABLE and press the **ENT** key. The following pop-up screen appears.

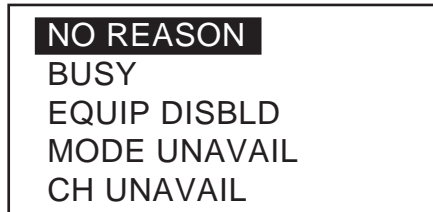

5. Choose the appropriate option and press the **ENT** key.

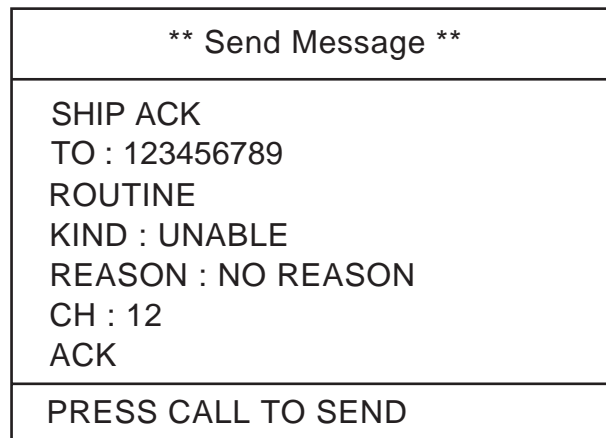

6. Press the **CALL** key more than three seconds to transmit the ACK BQ. The display changes to the standby display.

3.2 Group Call

A group call is for calling a specific group by specifying its group ID. When you set the group call in a message file, its group ID is stored automatically for your ship's group ID (see paragraph 4.5). To confirm group IDs, open the SYSTEM menu.

3.2.1 Sending a group call

1. Press the **CALL** key. The display changes to the COMPOSE MESSAGE screen and the CALL TYPE is displayed in reverse video.

2. Press the **ENT** key to open the call type list.

<p>COAST CALL SHIP CALL GROUP CALL PSTN CALL ALL SHIPS ▼ POSITION</p>	<p>▲ TEST RELAY ALL RELAY SEL DISTRESS</p>
--	--

3. Rotate the **CH** knob (or press up / down arrow key) to choose GROUP CALL and press the **ENT** key.
4. GROUP ID is selected; press the **ENT** key.
5. Key in a group ID and press the **ENT** key.
6. Choose CH and press the **ENT** key. The following window appears.

<p>SELECT CH MANUAL</p>

7. Choose SELECT CH or MANUAL as appropriate followed by pressing the **ENT** key.
8. If you chose SELECT CH at above step, the following channel list appears. Rotate the **CH** knob (or press up / down arrow key) to choose a channel you wish to communicate and press the **ENT** key.

SIMP CHANNEL		
06	15	73
08	16	74
09	17	75
10	67	76
11	68	77
12	69	87
13	71	88
14	72	

If you choose MANUAL at above step, enter channel number desired with numeric keys.

9. Press the **CALL** key more than three seconds. A message will be transmitted.

3. DSC OPERATION FOR NON-DISTRESS CASES

3.2.2 Receiving a group call

Group ID must be registered in order to receive a group call. See paragraph 4.5.

1. When a group call is received, the alarm sounds and the ALARM LED blinks two minutes.

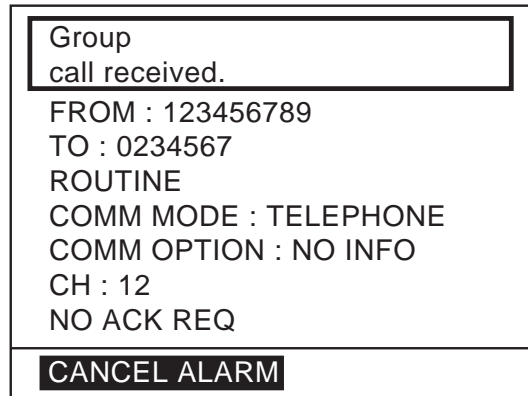

2. Press the **CANCEL** or **ENT** key to silence the alarm. The following display appears.

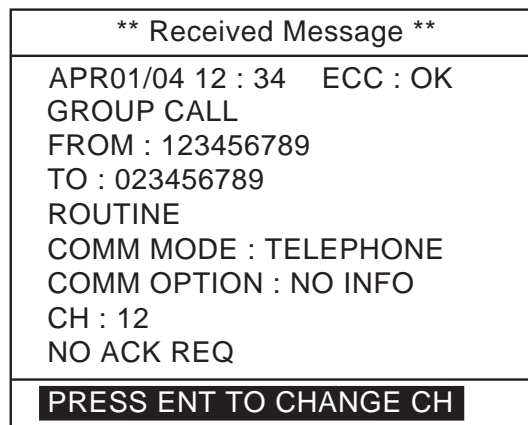

3. Press the **ENT** key. You can now communicate with the party, over the VHF channel specified.

Note: If you press the **ACK** key, instead of **CANCEL** or **ENT** key at step 2 above, the display changes to the standby display, indicating channel specified.

3.3 PSTN Call

The PSTN call allows the making and receiving of telephone calls over public switched telephone networks. To use the PSTN call feature, use a handset which has a HOOK ON/OFF function. The standard supply handset has this feature.

3.3.1 Sending a PSTN call

1. Press the **CALL** key. The display changes from standby display to the COMPOSE MESSAGE screen and the CALL TYPE is displayed in reverse video.
2. Press the **ENT** key to open the call type list.

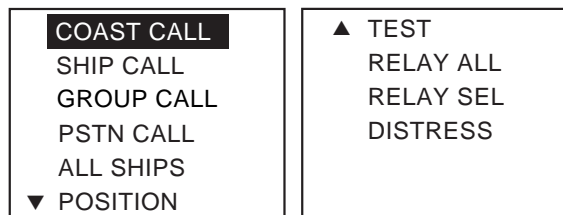

3. Rotate the **CH** knob (or press up / down arrow key) to choose PSTN CALL and press the **ENT** key.

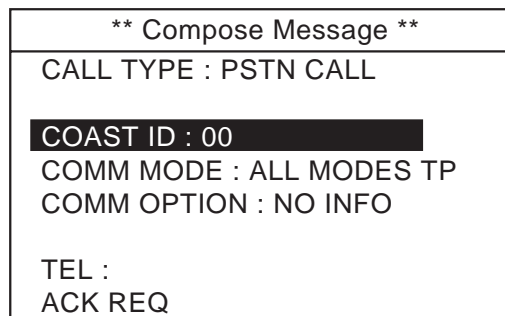

4. COAST ID is selected; press the **ENT** key.
5. Key in a coast ID and press the **ENT** key.
6. COMM MODE is selected; press the **ENT** key.
7. Choose ALL MODES TP, DUPLEX TP or DATA as appropriate followed by pressing the **ENT** key.
8. TEL is selected; press the **ENT** key.
9. Key in a subscriber's telephone number (max. 16 digits). Below are
 - **Deleting digit's one by one:** Press the **SHIFT** key to delete digit one by one from right side and enter a correct number.
 - **Correct one digit:** Select digit by rotating the CHANNEL knob and overwrite it.
 - **Delete all digits:** Locate the cursor at most right side and press the **SHIFT** key several times.
10. Press the **ENT** key.

3. DSC OPERATION FOR NON-DISTRESS CASES

11. Press the **CALL** key more than three seconds.

Call in progress on CH70
COAST ID : 003456789 COMM MODE : DUPLEX TP COMM OPTION : NO INFO NAME : FURUNO TEL : 81798631131 ACK REQ
AUTO RETRY IN : 5S

When TEL no. is registered,
the registered name is displayed.

If a response from the coast station is received within five seconds, transmit PSTN CALL signal and then carrier frequency during two seconds. Then your phone rings. Press the **CANCEL** key to stop the calling sound and change to standby display. Hook off and communicate with other party.

Note: If using a hand-microphone, pressing the **CANCEL** key is equal to off-hook.

3.3.2 PSTN call disconnection (ship disconnects line)

1. After hanging up the handset or pressing the **CANCEL** key to complete your call, the display shows the following message. The end of call signal is transmitted; and the system then waits for a response from the coast station.

Waiting for acknowledgement
TO : 003456789 COMM MODE : ALL MODES TP COMM OPTION : NO INFO TEL : 1234567890123456 CH : 28 ACK REQ

2. When the ACK from the coast station is received, the following display appears. The communication time (charge time) is informed.

Able acknowledge call received.
FROM : 003456789 KIND : END CALL COMM OPTION : NO INFO TEL : 1234567890123456 CHARGE TIME : 00h05m18s ACK
PRESS ENT

3.3.3 PSTN call disconnection (coast station disconnects line)

1. The PSTN line is disconnected by the coast station when it finds no evidence of communications or the land subscriber hangs up. The coast station then sends charge information as below.

PSTN end of call received.
FROM : 003456789 KIND : END CALL COMM OPTION : NO INFO TEL : 1234567890123456 CHARGE TIME : 00h06m18s ACK
PRESS ENT

3.3.4 Receiving a PSTN call

1. When a PSTN call is received, the following display appears. Your phone rings.

Able PSTN call Pick up the handset!
FROM : 003456789 COMM MODE : ALL MODES TP COMM OPTION : NO INFO TEL No : 1234567890123456 CH : 28 ACK REQ

2. Hook off within 60 seconds. The channel changes automatically and you can communicate with other party.
3. When the communication is completed, hook on the handset or press the **CANCEL** key.

3.4 All Ships Call

When an urgent but not life-endangering situation arises on your ship, for example, engine trouble, send an all ships call to request assistance.

After sending the call, you can communicate by voice over the radiotelephone. Do the following before beginning actual communications:

URGENCY priority: Say PAN three times followed by your call sign.

SAFETY priority: Say SECURITE three times followed by your call sign.

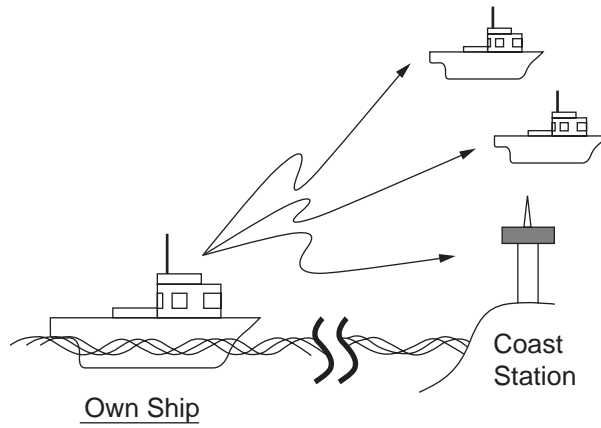

3.4.1 Sending an all ships call

1. Press the **CALL** key. The display changes from standby display to the COMPOSE MESSAGE screen and the CALL TYPE is displayed in reverse video.
2. Press the **ENT** key to open the call type list.

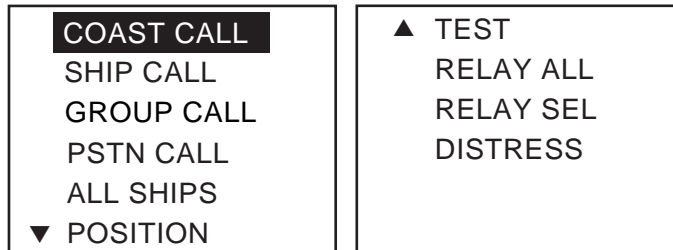

3. Rotate the **CH** knob (or press up / down arrow key) to choose ALL SHIPS and press the **ENT** key.
4. SAFETY is selected; press the **ENT** key.
5. Choose SAFETY or URGENCY as appropriate followed by pressing the **ENT** key.
6. If you choose SAFETY at above step, choose CH and press the **ENT** key. The following window appears.



If you choose URGENCY, go to step 9.

3. DSC OPERATION FOR NON-DISTRESS CASES

7. Choose **SELECT CH** or **MANUAL** as appropriate followed by pressing the **ENT** key.
8. If you chose **SELECT CH**, the following channel list appears. Rotate the **CH** knob (or press up / down arrow key) to choose a channel and press the **ENT** key.

SIMP CHANNEL		
06	15	73
08	16	74
09	17	75
10	67	76
11	68	77
12	69	87
13	71	88
14	72	

If you choose **MANUAL** at above step, enter channel number desired with numeric keys.

9. Press the **CALL** key more than three seconds to transmit the call. After transmitting the message, the screen changes to standby display.

3.4.2 Receiving an all ships call

1. When an all ships call is received, the audio alarm sounds and the display looks something like the one shown below.

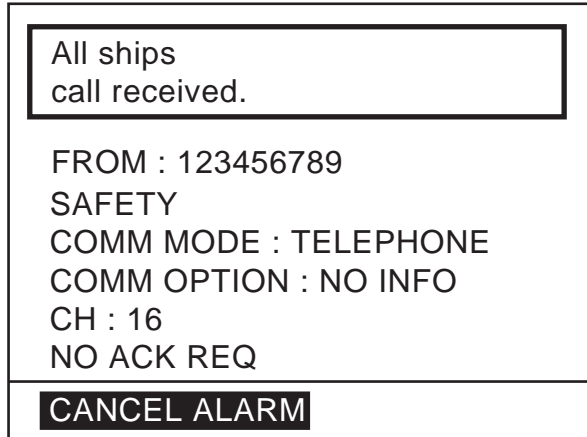

2. Press the **CANCEL** or **ENT** key to silence the alarm. The display changes as follows.

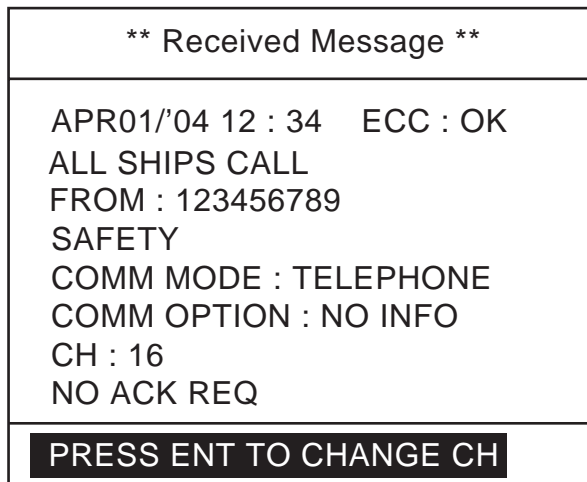

3. Press the **ENT** key. The display changes to the standby display, indicating channel specified, and you can watch the contents of the message.

Note: If you press the **ACK** key, instead of **CANCEL** or **ENT** key at step 2 above, the display changes to the standby display, indicating channel specified.

3.5 Position Call

There are two types of position calls: other station requires your ship's position and your ship requests position of another ship.

Finding position of other station

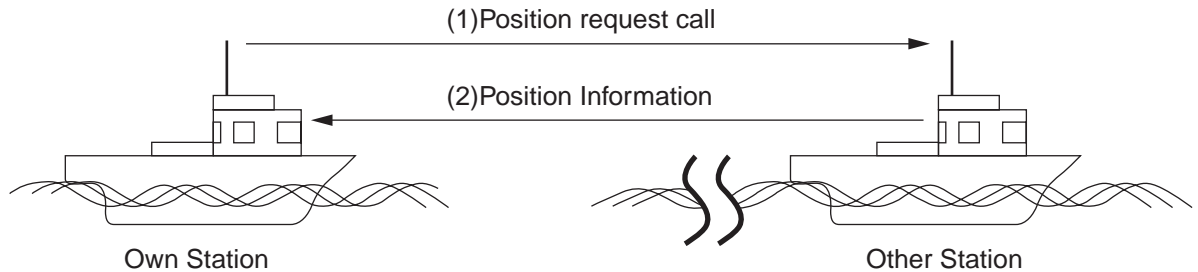

Sending own ship's position to other station

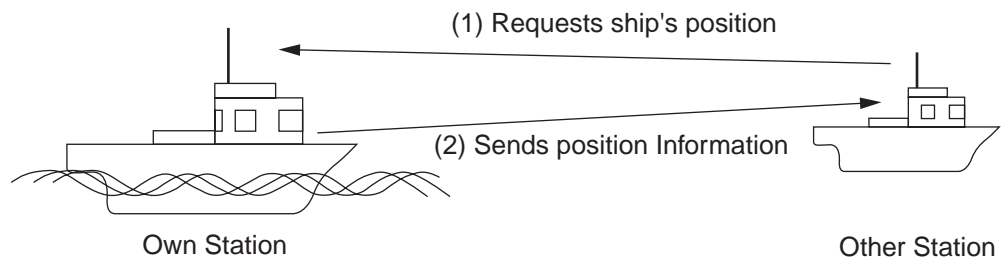

3.5.1 Position call: requesting other ship's position

1. Press the **CALL** key. The display changes from standby display to the COMPOSE MESSAGE screen and the CALL TYPE is displayed in reverse video.
2. Press the **ENT** key to open the call type list.
3. Rotate the **CH** knob (or press up / down arrow key) to choose POSITION and press the **ENT** key.

** Compose Message **	
CALL TYPE : POSITION REQUEST	
TO :	_____
SHIP ID :	
SAFETY	
KIND : POSITION REQ	
COMM OPTION : NO INFO	
ACK REQ	

If a file is registered, its registration name is displayed. If not, this field is blank.

4. SHIP ID is selected; press the **ENT** key.
5. Key in a ship ID for which you want to know its position.
6. Press the **ENT** key.

3. DSC OPERATION FOR NON-DISTRESS CASES

7. Press the **CALL** key more than three seconds to transmit position request. The following display appears. The timer counts down until a response is received.

Waiting for acknowledgement.
SHIP ID : 123456789 SAFETY KIND : POSITION REQ COMM OPTION : NO INFO ACK REQ
TIME TO GO : 3M30 S

If a file is registered, its registration name is displayed.
If not, this field is blank.

8. When an acknowledge call is received, the following display appears and the audio alarm sounds.

Position acknowledge received.
FROM : 123456789 SAFETY KIND : POSITION REQ COMM OPTION : NO INFO POS : 12° 34' N 123° 45' E AT 12 : 34 ACK
CANCEL ALARM

9. Press the **CANCEL** key to silence the alarm. The display looks as below. You can now confirm position of other ship.

** Received Message **
APR01/04 12 : 34 ECC : OK POSITION ACK FROM : 123456789 SAFETY KIND : POSITION REQ COMM OPTION : NO INFO POS : 12° 34' N 123° 45' E AT 12 : 34 ACK
PRESS ENT

10. When "No response! Try calling again?" is displayed;
Re-send call: Push the **ENT** key followed by the **CALL** key.
Cancel call: Press the **CANCEL** key.

3.5.2 Position call: other ship requests your position

1. When a position request call is received, the audio alarm sounds and the display changes as below.

<div style="border: 1px solid black; padding: 2px;">Position request call received.</div>
FROM : 123456789 SAFETY KIND : POSITION REQ COMM OPTION : NO INFO ACK REQ
<div style="background-color: black; color: white; padding: 2px; text-align: center;">CANCEL ALARM</div>

2. Press the **CANCEL** key to silence the alarm.

** Received Message **
APR01/04 12 : 34 ECC : OK POSITION CALL FROM : 123456789 SAFETY KIND : POSITION REQ COMM OPTION : NO INFO ACK REQ
<div style="background-color: black; color: white; padding: 2px; text-align: center;">PRESS ENT TO ACK.</div>

3. To send your position manually, press the **ENT** key. The following pop-up menu appears.

<div style="background-color: black; color: white; padding: 2px; text-align: center;">ANSWER</div> NO ANSWER

4. Choose ANSWER by the **CH** knob and press the **ENT** key.
5. Press the **CALL** key more than three seconds to send your position data. Then, the standby display appears.
To send no position data, choose NO ANSWER and press the **ENT** key twice to return to the standby display.

3.6 Receiving a Polling Call

3.6.1 Automatic reply

1. When a polling request call is received and the equipment is set up for automatic acknowledge POLLING CALL ON at the AUTO ACK menu and the **ACK** key is set to show AUTO ACK on the display, the display changes as shown in the illustration below and the audio alarm sounds.

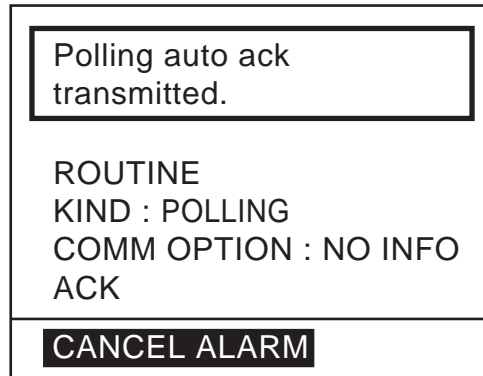

2. Press the **CANCEL** or **ENT** key to silence the alarm. The display changes as below.

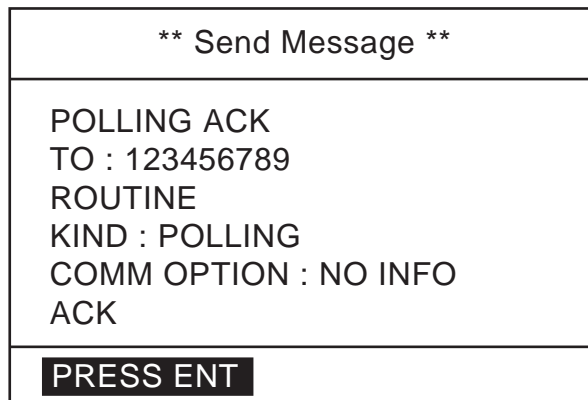

3.6.2 Manual reply

1. When a polling request call is received and the setting of POLLING CALL on the AUTO ACK menu is OFF or the **ACK** key is set to show MANUAL ACK on the display, the display changes as shown in the illustration below and the audio alarm sounds.

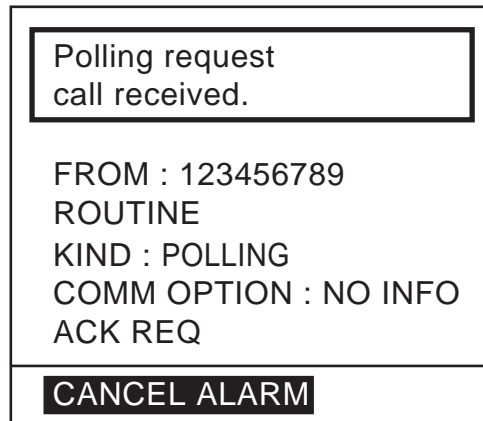

2. Press the **CANCEL** key to silence the alarm. The display changes as below.

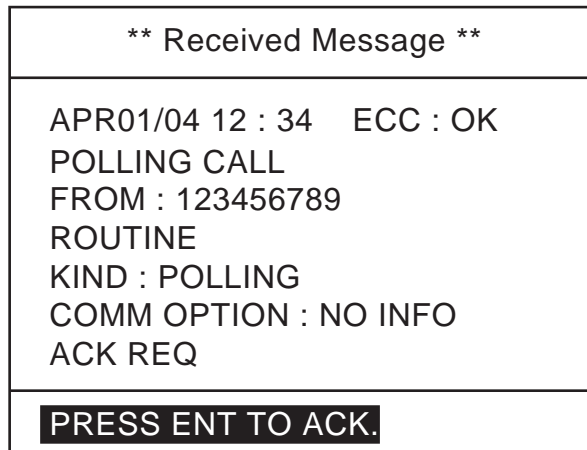

3. To respond to the call, press the **ENT** key. The following pop-up window appears.



4. Choose ANSWER by the **CH** knob and press the **ENT** key.
5. Press the **CALL** key more than three concords to send the polling acknowledge call. Then the standby display appears.
To send no reply, choose NO ANSWER and press the **ENT** key twice to return to the standby display.

3.7 Neutral Craft Call

The neutral craft call, which contains own ship position and ID, informs all ships that your ship is not a participant in armed conflict. Send the call BEFORE entering an area of armed conflict.

To enable the neutral craft call, set the NEUTRAL CALL to ABLE in the SPECIAL CALL menu. See section "4.9 Special Call Setup."

3.7.1 Sending a neutral craft call

1. Press the **CALL** key. The display changes from the standby display to the COMPOSE MESSAGE screen and the CALL TYPE is displayed in reverse video.
2. Press the **ENT** key to open the call type list.
3. Rotate the **CH** knob (or press up / down arrow key) to choose SPECIAL and press the **ENT** key.



Note: The NEUTRAL and/or MEDICAL are indicated if each one is set to ABLE in the SPECIAL MENU. See page 4-15.

4. Choose NEUTRAL and press the **ENT** key.

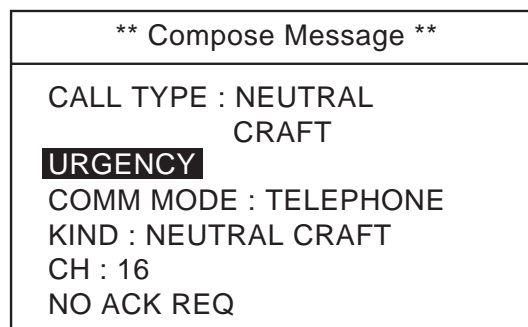

5. Press the **CALL** key more than three seconds to transmit the call. After the call is transmitted, the standby display appears with CH16 selected.

3.7.2 Receiving a neutral craft call

1. When a neutral craft call is received, the alarm sounds and the display changes as below.

Neutral craft call received.
FROM : 123456789 URGENCY COMM MODE : TELEPHONE KIND : NEUTRAL CRAFT CH : 16 NO ACR REQ
CANCEL ALARM

2. Press the **CANCEL** or **ENT** key. The audible alarm is silenced and the display changes as below.

** Received Message **
APR01/04 12 : 34 ECC : OK NEUTRAL CALL FROM : 123456789 URGENCY COMM MODE : TELEPHONE KIND : NEUTRAL CRAFT CH : 16 NO ACK REQ
PRESS ENT TO CHANGE CH

3. Press the **ENT** key. The display changes to the standby display, indicating CH16.

3.8 Medical Transport Call

The medical transport call informs all ships, by urgency priority, that own ship carries medical supplies.

To enable the medical transport call, set the MEDICAL CALL to ABLE in the SPECIAL CALL menu. See section “4.9 Special Call Setup.”

3.8.1 Sending a medical transport call

1. Press the **CALL** key. The display changes from the standby display to the COMPOSE MESSAGE screen and the CALL TYPE is displayed in reverse video.
2. Press the **ENT** key to open the call type list.
3. Rotate the **CH** knob (or press up / down arrow key) to choose the SPECIAL and press the **ENT** key.



Note: The NEUTRAL and/or MEDICAL are indicated if each one is set to ABLE in the SPECIAL MENU. See page 4-15.

4. Choose MEDICAL and press the **ENT** key.

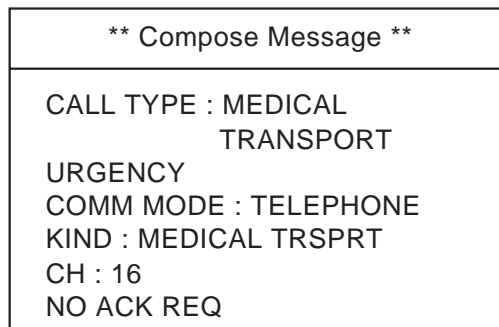

5. Press the **CALL** key more than three seconds to transmit the call. After the call is transmitted, the standby display appears, with CH16 selected.

3.8.2 Receiving a medical transport call

1. When a medical call is received, the alarm sounds and the display changes as below.

<div style="border: 1px solid black; padding: 2px; margin-bottom: 5px;"> Medical call received. </div> <p> FROM : 123456789 URGENCY COMM MODE : TELEPHONE KIND : MEDICAL CH : 16 NO ACK REQ </p>
<div style="background-color: black; color: white; padding: 2px 10px; display: inline-block;"> CANCEL ALARM </div>

2. Press the **CANCEL** or **ENT** key. The audible alarm stops and the display changes as below.

** Received Message **
<p> APR01/04 12 : 34 ECC : OK MEDICAL CALL FROM : 123456789 URGENCY COMM MODE : TELEPHONE KIND : MEDICAL CH : 16 NO ACK REQ </p>
<div style="background-color: black; color: white; padding: 2px 10px; display: inline-block;"> PRESS ENT TO CHANGE CH </div>

3. Press the **ENT** key. The display changes to the standby display, indicating CH16.

3.9 Log File

Three log files are provided for storage of calls: received ordinary log, received distress log and transmitted log. Each log file stores 50 calls, on a first-in, first-out basis. This means that the latest call is saved as log no.1 and the log no. of all previous calls in that log increments by one. When the storage capacity is exceeded, the oldest call is deleted to make room for the latest. A letter mark shows unread calls. Received distress calls are automatically deleted 48 hours after being read.

Opening a log file

The procedure for opening a log is common to all logs.

1. Press the **LOG** key to open the SELECT LOG FILE display.

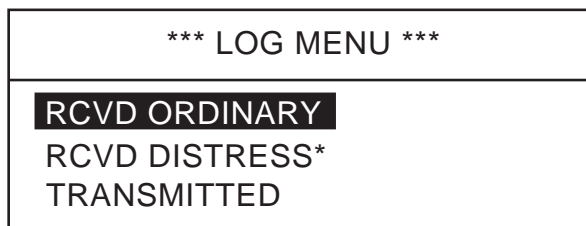

*: All received messages of the category DISTRESS are stored.

2. Rotate the **CH** knob to choose RCVD ORDINARY, RCVD DISTRESS or TRANSMITTED as appropriate and press the **ENT** key. For example, choose RCVD ORDINARY or TRANSMITTED.

RCVD ORDINARY LOG 1/13	TRANSMITTED 1/13								
<table style="width: 100%; border-collapse: collapse;"> <tr style="background-color: #cccccc;"> <td style="padding: 2px;">01: APR 10/04 12:30 SHIP ACK</td> </tr> <tr> <td style="padding: 2px;">02: APR 15/04 10: 15 ALL SHIPS</td> </tr> <tr> <td style="padding: 2px;">03: APR 25/04 11: 30 <input type="checkbox"/> COAST CALL</td> </tr> <tr> <td style="padding: 2px;">04: MAY10/04 18: 30 ▼ COAST CALL</td> </tr> </table>	01: APR 10/04 12:30 SHIP ACK	02: APR 15/04 10: 15 ALL SHIPS	03: APR 25/04 11: 30 <input type="checkbox"/> COAST CALL	04: MAY10/04 18: 30 ▼ COAST CALL	<table style="width: 100%; border-collapse: collapse;"> <tr style="background-color: #cccccc;"> <td style="padding: 2px;">01: APR 10/04 12:35 SHIP CALL</td> </tr> <tr> <td style="padding: 2px;">02: APR 15/04 10: 25 ALL SHIPS CALL</td> </tr> <tr> <td style="padding: 2px;">03: APR 25/04 12: 30 COAST CALL</td> </tr> <tr> <td style="padding: 2px;">04: MAY10/04 19: 30 ▼ COAST CALL</td> </tr> </table>	01: APR 10/04 12:35 SHIP CALL	02: APR 15/04 10: 25 ALL SHIPS CALL	03: APR 25/04 12: 30 COAST CALL	04: MAY10/04 19: 30 ▼ COAST CALL
01: APR 10/04 12:30 SHIP ACK									
02: APR 15/04 10: 15 ALL SHIPS									
03: APR 25/04 11: 30 <input type="checkbox"/> COAST CALL									
04: MAY10/04 18: 30 ▼ COAST CALL									
01: APR 10/04 12:35 SHIP CALL									
02: APR 15/04 10: 25 ALL SHIPS CALL									
03: APR 25/04 12: 30 COAST CALL									
04: MAY10/04 19: 30 ▼ COAST CALL									

3. Rotate the **CH** knob to choose a file you wish to browse.
The in the RCVD ORDINARY LOG indicates unread message.

4. Press the **ENT** key to open the message. Below is a sample message.

** Received Message **		
APR 10/04 18:30 ECC : OK SHIP CALL TO : 123456789 ROUTINE COMM MODE : TELEPHONE COMM OPTION : NO INFO CH : 16 ACK REQ		
DELETE	▲ ▼	ANSWER

For a received message which requires a reply, ANSWER is displayed (for 4.5 minutes). To reply choose it with CHANNEL knob and press the ENT key.

5. Press ▲ or ▼ key to open previous or next page on the log.
 6. If you wish to print the file selected, press the **PRINT** key.
 7. If you wish to delete the file selected, choose DELETE with the **CHANNEL** knob and press the **ENT** key.
 The following confirmation window appears.

DELETE RECEIVED LOG ARE YOU SURE? YES NO

8. Choose YES and press the **ENT** key.

Resending from the Transmitted log

1. Open a transmitted message that is required retransmission.

** Transmitted Message **		
FEB 10/09 18:30 SHIP CALL TO : 123456789 ROUTINE COMM MODE : TELEPHONE COMM OPTION : NO INFO CH : 16 ACK REQ		
DELETE	▲ ▼	RESEND

2. Select RESEND with the **CHANNEL** knob and press the **ENT** key.
 3. Press the **CALL** key more than three seconds.

3. DSC OPERATION FOR NON-DISTRESS CASES

This page is intentionally left blank.

4. BASIC SETUP

4.1 Alarm Setup

This section provides the procedures for setting up various alarms. The alarm menu enables/disables internal and external alarms. Note that the Distress/Urgency alarm cannot be disabled.

Old position alarm in manual position entry mode

This alerts the operator when manually entered position data is older by the number of hours or minutes set.

1. Press the **MENU** key.

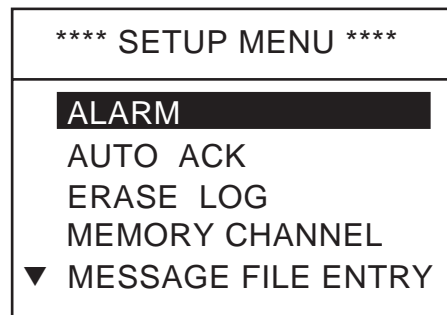

SETUP MENU on transceiver unit



SETUP MENU on remote handset

2. ALARM is selected; press the **ENT** key to display the ALARM menu.



ALARM MENU on transceiver unit



ALARM MENU on remote handset

3. Rotate the **CH** knob (or press up / down arrow key) to choose POSITION OLDER (POS. OLDER for remote handset) from the ALARM MENU and press the **ENT** key. The following setting window appears.

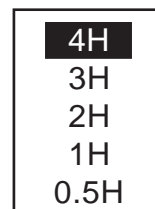

4. Rotate the **CH** knob (or press up / down arrow key) to choose an appropriate value and press the **ENT** key.

Alarm is output when position is older by the number of hours set here.

5. Press the **CANCEL** key twice to return to standby display.

To set type of alarm to output

1. Rotate the **CH** knob (or press up / down arrow key) to choose EXT ALARM from the ALARM MENU and press the **ENT** key. The following setting window appears.

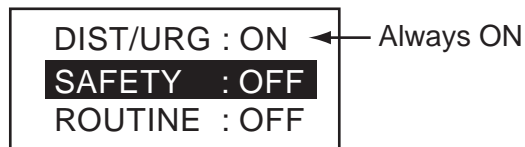

2. Rotate the **CH** knob (or press up / down arrow key) to choose an appropriate option. Alarm is output to external device.
DIST/URG: Distress or urgency call output upon receipt.
SAFETY: Safety call output upon receipt.
ROUTINE: Routine call output upon receipt.
3. Press the **ENT** key.
4. Choose ON or OFF as appropriate and press the **ENT** key.
5. Press the **CANCEL** key three times to return to the standby display.

4.2 Auto ACK Setup

The Auto Ack Menu enables/disables automatic acknowledgement of ship, coast, and polling calls.

Comply status Setting of SHIFT → 5ACK key	ABLE	UNABLE
AUTO ACK	Can send ABLE acknowledge automatically.	Can send UNABLE acknowledge automatically.
MANUAL ACK	Can send ABLE acknowledge manually	Can send UNABLE acknowledge manually.

To set COMPLY Status

1. Press the **MENU** key.
2. Rotate the **CH** knob (or press up / down arrow key) to choose AUTO ACK and press the **ENT** key. The following menu appears.

```

**** AUTO ACK MENU ****
COMPLY STATUS ABLE
UNABLE REASON
          NO REASON
POLLING CALL      ON
  
```

3. COMPLY STATUS is selected; press the **ENT** key. The following setting window appears.

```

ABLE
UNABLE
  
```

4. Rotate the **CH** knob (or press up / down arrow key) to choose ABLE or UNABLE.
5. Press the **ENT** key.

Note: Automatic acknowledge is automatically disabled when RX call contains error, as required by law. Further, automatic acknowledge is disabled in case of OFF HOOK.

4. BASIC SETUP

To set reason for unable

If you have chosen UNABLE as the COMPLY STATUS, set the reason as follows:

1. Rotate the **CH** knob (or press up / down arrow key) to choose UNABLE REASON from the AUTO ACK MENU and press the **ENT** key. The following menu appears.

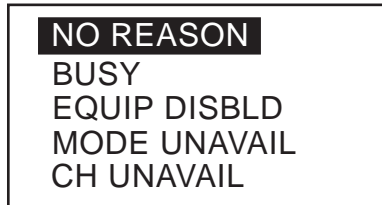

2. Rotate the **CH** knob (or press up / down arrow key) to choose a reason for UNABLE.
3. Press the **ENT** key.

Note: This menu is the same as manual acknowledgement. EQUIPMENT DISABLED is shown in calls when EQUIP DISBLD is selected.

To set polling call response

1. Rotate the **CH** knob (or press up / down arrow key) to choose the POLLING CALL from the AUTO ACK MENU and press the **ENT** key.
2. Rotate the **CH** knob (or press up / down arrow key) to choose ON or OFF as appropriate.
OFF: Disables automatic acknowledgement of polling request.
ON: Enables automatic acknowledgement of polling request.
3. Press the **ENT** key.

4.3 Erasing Logs

Erasing received ordinary log

1. Press the **MENU** key.
2. Rotate the **CH** knob (or press up / down arrow key) to choose ERASE LOG and press the **ENT** key. The following window appears.

```

*** ERASE LOG MENU ***
RCVD ORDINARY
RCVD DISTRESS
TRANSMITTED
  
```

3. RCVD ORDINARY is selected; press the **ENT** key to erase the received ordinary log.

```

ERASE
RCVD ORDINARY
ARE YOU SURE?
YES          NO
  
```

4. Choose YES and press the **ENT** key to erase the received ordinary log.

Erasing received distress log

1. Press the **MENU** key.
2. Rotate the **CH** knob (or press up / down arrow key) to choose ERASE LOG and press the **ENT** key.
3. Rotate the **CH** knob (or press up / down arrow key) to choose RCVD DISTRESS and press the **ENT** key to erase the received distress log.

```

ERASE
RCVD DISTRESS
ARE YOU SURE?
YES          NO
  
```

4. Choose YES and press the **ENT** key to erase the received distress log.

Erasing transmitted log

1. Press the **MENU** key.
2. Rotate the **CH** knob (or press up / down arrow key) to choose ERASE LOG and press the **ENT** key.
3. Rotate the **CH** knob (or press up / down arrow key) to choose TRANSMITTED and press the **ENT** key.

```

ERASE
TRANSMITTED
ARE YOU SURE?
YES          NO
  
```

4. Choose YES and press the **ENT** key to erase the transmitted message log.

4.4 Memory Channel Setup

You can save up to 50 channels as follows.

1. Press the **MENU** key.
2. Rotate the **CH** knob (or press up / down arrow key) to choose MEMORY CHANNEL and press the **ENT** key.

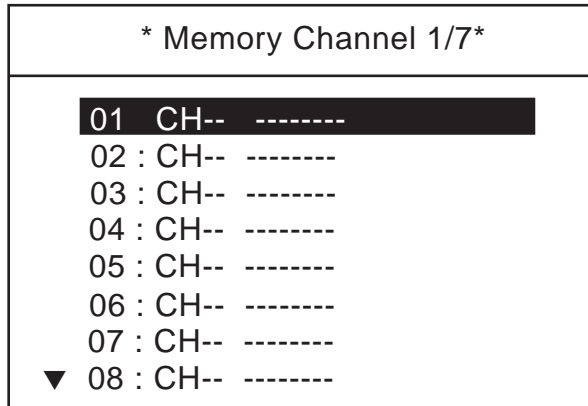

3. Rotate the **CH** knob (or press up / down arrow key) to choose a vacant CH number and press the **ENT** key.

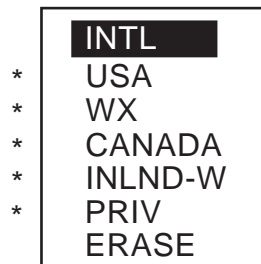

* : Only permitted channel modes are displayed, which are set by the installer of the equipment.

4. Rotate the **CH** knob (or press up / down arrow key) to choose appropriate channel type and press the **ENT** key.
5. Rotate the **CH** knob (or press up / down arrow key) to choose channel number and press the **ENT** key.

To erase a channel, choose a channel to erase at step 3 and ERASE at step 4 followed by the **ENT** key.

Note: To set memory channel at the remote station, use [2] or [8] key.

4.5 Message File Entry

In this section you will learn how to prepare and store ship, coast, PSTN, and group calls for future transmission. 100 calls can be stored.

1. At the standby display, press the **MENU** key to open the SETUP MENU.

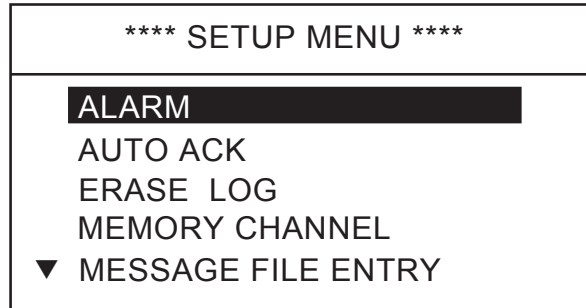

2. Rotate the **CH** knob (or press up / down arrow key) to choose MESSAGE FILE ENTRY and press the **ENT** key.

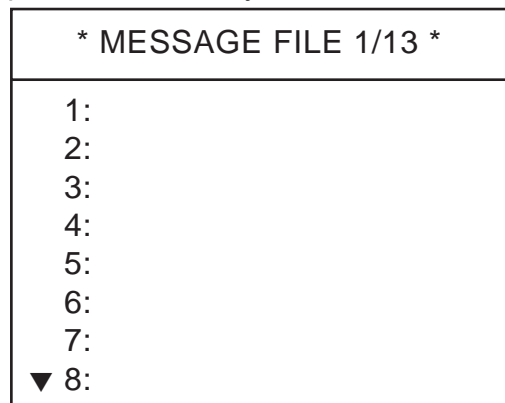

3. Rotate the **CH** knob to choose a vacant number and press the **ENT** key. The following selection window appears.



4. BASIC SETUP

4. Rotate the **CH** knob to choose the call type and press the **ENT** key. One of the following display appears depending on the call type selected above.

MESSAGE FILE 1 ENTRY
CALL TYPE : COAST CALL COAST ID : 00 ROUTINE COMM MODE: TELEPHONE COMM OPTION: NO INFO CH : NO INFO ACK REQ NAME :
REGIST ERASE

In case of Coast call

MESSAGE FILE 1 ENTRY
CALL TYPE : SHIP CALL SHIP ID : ROUTINE COMM MODE: TELEPHONE COMM OPTION: NO INFO CH : 16 ACK REQ NAME :
REGIST ERASE

In case of Ship call

MESSAGE FILE 1 ENTRY
CALL TYPE : GROUP CALL GROUP ID : 0 ROUTINE COMM MODE: TELEPHONE COMM OPTION: NO INFO CH : 16 NO ACK REQ NAME :
REGIST ERASE

In case of Group call

MESSAGE FILE 1 ENTRY
CALL TYPE : PSTN CALL COAST ID : 00 COMM MODE: DUPLEX TP COMM OPTION: NO INFO TEL : ACK REQ NAME :
REGIST ERASE

In case of PSTN call

Note1: The communication priority is ROUTINE only.

Note2: The group ID will be registered automatically after a group call message file is saved.

Note3: If you register a group call, its group ID becomes your own group ID.

5. Press the **ENT** key and key in each ID followed by the **ENT** key.
6. COMM MODE is selected; press the **ENT** key.

TELEPHONE DATA

7. Choose TELEPHONE or DATA as appropriate followed by pressing the **ENT** key. The COMM OPTION field always shows NO INFO.
8. Choose CH and press the **ENT** key. The following window appears.

SELECT CH MANUAL

9. Choose SELECT CH with the **CH** knob (or up / down arrow key) and press the **ENT** key.

SIMP CHANNEL		
06	15	73
08	16	74
09	17	75
10	67	76
11	68	77
12	69	87
13	71	88
14	72	

In case of MANUAL, enter the channel number with numeric keys manually.

10. Choose a channel with the **CH** knob (or up / down arrow key) and press the **ENT** key.
11. Press the **ENT** key to open the name entry window.
12. Enter a name with the alphanumeric keys. To change a digit, rotate the **CH** knob. Press the **ENT** key.

MESSAGE FILE 1 ENTRY	
CALL TYPE :	COAST CALL
COAST ID :	0012345678
ROUTINE	
COMM MODE:	TELEPHONE
COMM OPTION:	NO INFO
CH :	NO INFO
ACK REQ	
NAME :	ABCD
REGIST	ERASE

In case of Coast call

13. **REGIST** is selected; press the **ENT** key to register. To erase, rotate the **CH** knob to select **ERASE** and press the **ENT** key.

4. BASIC SETUP

To send a message file:

Method1

- 1) Press the **CALL** key.
- 2) Choose call type and press the **ENT** key.
- 3) Highlighting xxx ID, press the **FILE** key to display list of message files.
- 4) Choose file to send and press the **ENT** key.
- 5) Set the Routine, COMM MODE, and CH.
- 6) Press the **CALL** key more than three seconds.

Method2

- 1) Press the **FILE** key at the standby display.
- 2) Choose a file you want to send and press the **ENT** key.
- 3) Press the **CALL** key more than three seconds.

4.6 Position Setup

This is where you enter your position, automatically or manually.

1. Press the **MENU** key at the standby display.
2. Rotate the **CH** knob (or press up / down arrow key) to choose POSITION from the second page of the main menu.

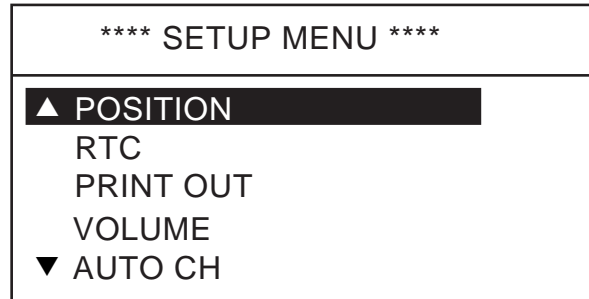

3. Press the **ENT** key. The following menu appears.

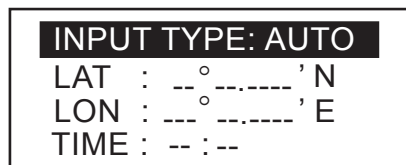

4. INPUT TYPE is selected; press the **ENT** key. The following setting window appears.



Note: If the position data from a positioning sensor is available, MANUAL can not be chosen, i.e. the above window does not open.

5. Rotate the **CH** knob (or press up / down arrow key) to choose AUTO or MANUAL as appropriate and press the **ENT** key.

If you chose AUTO, your ship's position and time appear; press the **CANCEL** to close the menu and return to the standby display. These data are supplied from the navigation equipment connected.

Note: • If correct position data is entered from a position source during the setting of MANUAL, the setting changes automatically to AUTO from MANUAL.

- If the message "EPFS ERROR" appears after you change INPUT TYPE from MANUAL to AUTO, confirm that the navigation device is functioning.

If you chose MANUAL, enter your position and time as follows.

6. Enter latitude (in eight digits) with the numeric keys. If necessary, switch coordinates: **1** key to switch to North; **2** key to switch to South.
7. Press the **ENT** key and enter longitude (in nine digits) with the numeric keys. If necessary, switch coordinates: **1** key to switch to East; **2** key to switch to West.
8. Press the **ENT** key and enter UTC time with the numeric keys.
9. Press the **ENT** key and **CANCEL** key to finish.

4.7 Print Out Setup

The PRINT MENU enables/disables automatic printing of all transmitted and received calls and the results of the daily test.

1. Press the **MENU** key at the standby display to open menu.
2. Rotate the **CH** knob (or press up / down arrow key) to choose PRINT OUT from the second page of the main menu and press the **ENT** key.

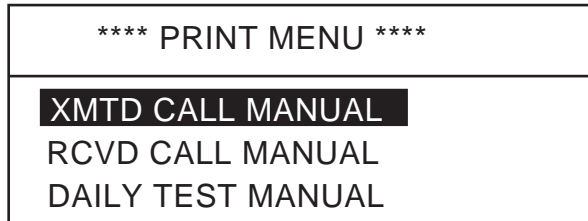

3. Choose appropriate item among XMTD CALL, RCVD CALL or DAILY TEST and press the **ENT** key.



4. Choose AUTO or MANUAL as appropriate and press the **ENT** key.
5. Press the **CANCEL** key twice to return to the standby display.

In the AUTO, when a message is received, its message automatically is printed out. In the MANUAL, open a message you want to print and press the **PRINT** key (see page 3-29).

Note: In the AUTO, you can print a message as same as Manual.

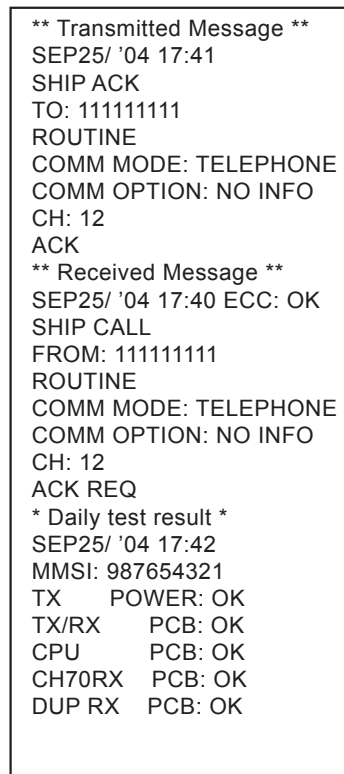

Sample printout

4.8 Volume Setup

The VOLUME menu enables/disables key beep (acknowledges correct key input) and adjusts the volume of the earpiece, intercom and off-hook loudspeaker.

1. Press the **MENU** key at the standby display.
2. Rotate the **CH** knob (or press up / down arrow key) to choose VOLUME and press the **ENT** key.

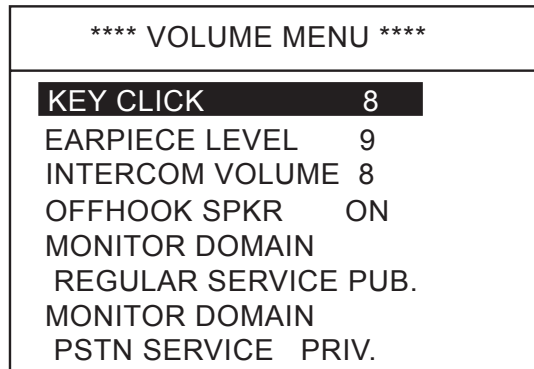

Follow the appropriate procedure to adjust volume of desired item.

Key click

1. Choose KEY CLICK, and press the **ENT** key.

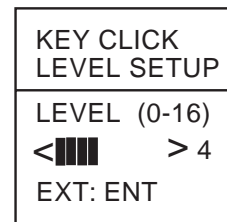
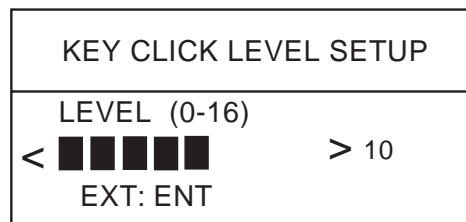

Note: Do not confuse keyboard beep (single beep) with ACK beep (three beeps).

2. Rotate the **CH** knob (or press up / down arrow key) to set the key click level. The setting range is 0 to 16.
3. Press the **ENT** key. (If you press the **CANCEL** key, the setting is not stored.)

Earpiece volume

Set KEY CLICK (see above section) to zero (0) then do the following:

1. Choose EARPIECE LEVEL and press the **ENT** key.

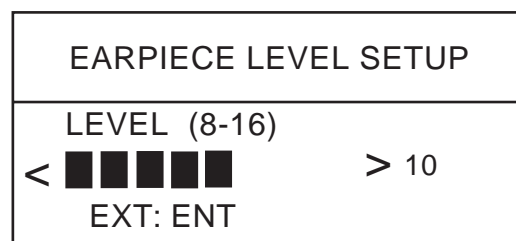

Transceiver unit

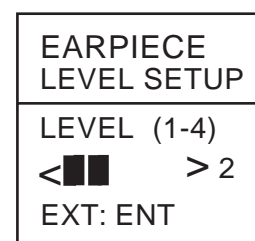

Remote handset

4. BASIC SETUP

2. Rotate the **CH** knob (or press up / down arrow key) to set the earpiece volume level. The setting range is 8 to 16 for transceiver handset and 1 to 4 for remote handset.
3. Press the **ENT** key. (If you press the **CANCEL** key, the setting is not stored.)

Intercom volume

1. Choose INTERCOM VOLUME and press the **ENT** key.

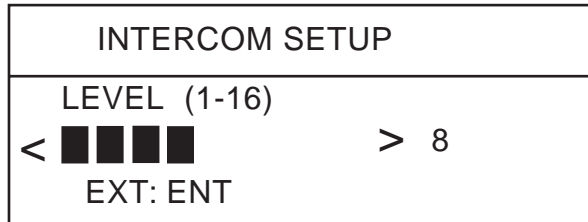

2. Rotate the **CH** knob (or press up / down arrow key) to set the intercom volume level. The setting range is 1 to 16.
3. Press the **ENT** key.

Off-hook loudspeaker

You can set the loudspeaker(s) (internal and external) on or off, according to off-hook condition.

1. Choose OFFHOOK SPKR and press the **ENT** key.
2. Choose ON or OFF and press the **ENT** key.
OFFHOOK SPKR ON: Loudspeaker(s) is activated when off-hook.
OFFHOOK SPKR OFF: Loudspeaker(s) is deactivated when off-hook.

Note: The loudspeaker in the transceiver unit can be set by above procedures.
The loudspeaker in the remote station is not affected.

Speaker Domain

You can enable or disable the monitoring of PSTN calls and regular calls (calls other than PSTN) for remote units.

1. Rotate the **CH** knob to choose [MONITOR DOMAIN REGULAR SERVICE] or [MONITOR DOMAIN PSTN SERVICE], and then press the **ENT** key.
2. Rotate the **CH** knob to choose PUB or PRIV as applicable.
PRIV (Private): For a speaker having priority
PUB (Public): For any speaker
3. Press the **ENT** key.

4.9 Special Call Setup

The Special Call menu enables/disables the neutral craft call and / or medical call.

1. Press the **MENU** key at the standby display.
2. Rotate the **CH** knob to choose SPECIAL CALL and press the **ENT** key.

**** SPECIAL MENU ****	
NEUTRAL CALL	: ABLE
MEDICAL CALL	: ABLE

3. Choose NEUTRAL CALL or MEDICAL CALL and press the **ENT** key.

ABLE
UNABLE

4. Choose ABLE to enable the chosen call, or UNABLE to disable it, and then press the **ENT** key.
5. Press the **CANCEL** key twice to return to the standby display.

If you select the ABLE, the menu item SPECIAL appears at the CALL TYPE menu.

COAST CALL SHIP CALL GROUP CALL PSTN CALL ALL SHIPS ▼ POSITION	▲ TEST RELAY ALL RELAY SEL DISTRESS SPECIAL
---	---

4.10 RTC Setup

The date and time are normally set from NMEA data. Also, you may enter manually as follows.

1. Press the **MENU** key at the standby display.
2. Rotate the **CH** knob to choose RTC and press the **ENT** key.

**** SETUP MENU ****	
▲ POSITION	
RTC	
DATE : 2006-01-24	
TIME : 01:24:17	
AUTO CH	
▼	

4. BASIC SETUP

3. Press the **ENT** key again to show date entry box.

DATE : 2005-08-24 TIME : 01:24:17
2006-01-24

4. Enter current date and press the **ENT** key.
Time entry box appears.
5. Enter current time and press the **ENT** key.
6. Press the **CANCEL** key to return to the standby display.

4.11 AUTO CH Setup

The automatic channel setup for reception of the coast call and the ship call may be set to enable or disable.

1. Press the **MENU** key at the standby display.
2. Rotate the **CH** knob to choose AUTO CH and press the **ENT** key.

**** AUTO CH MENU ****
AUTO CH : DISABLE

3. Press the **ENT** key to show the selection window.

ENABLE DISABLE

4. Rotate the **CH** knob to choose ENABLE or DISABLE as appropriate and press the **ENT** key.
5. Press the **CANCEL** key twice to return to the standby display.

4.12 PROPOSE CH Setup

If a PROPOSE calling comes from a coast station with no channel specified, own ship is required to suggest a working channel. This one can be set as follows.

1. Press the **MENU** key at the standby display.
2. Rotate the **CH** knob to choose PROPOSE CH and press the **ENT** key.

** PROPOSE CH MENU **
PROPOSE CH : 10

3. Press the **ENT** key to show the entry window.
4. Enter a new channel to specify the working channel and press the **ENT** key.
5. Press the **CANCEL** key twice to return to the standby display.

4.13 AUTO REVERT Setup

AUTO REVERT sets what channel to set when the handset is hung in the handset hanger. The default setting (ON) reverts to CH16.

1. Press the **MENU** key at the standby display.
2. Rotate the **CH** knob to choose AUTO REVERT and press the **ENT** key.



3. Press the **ENT** key to show the selection window.



4. Rotate the **CH** knob to choose OFF or ON as appropriate and press the **ENT** key.
OFF keeps the current channel.
5. Press the **CANCEL** key twice to return to the standby display.

4. BASIC SETUP

This page intentionally left blank.

5. SYSTEM SETUP

5.1 Displaying Self ID

1. Press the **MENU** key.

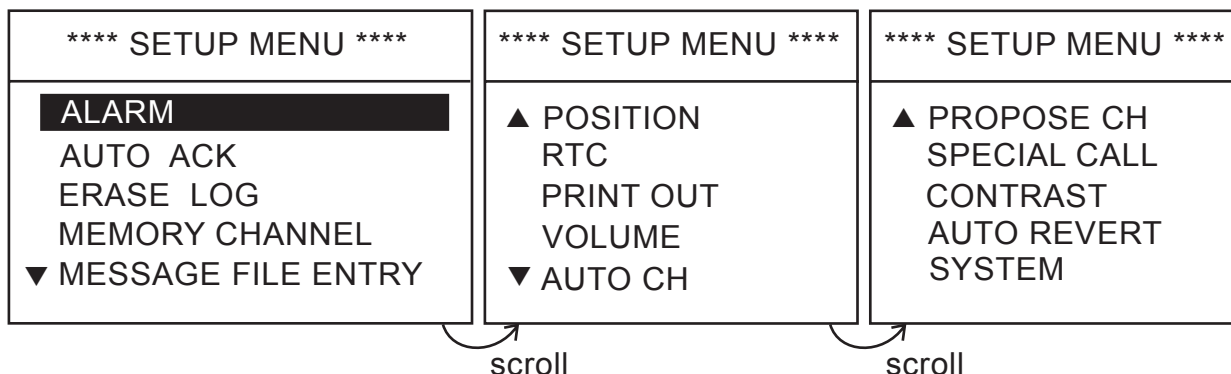

2. Rotate the **CH** knob (or press up / down arrow key) to choose SYSTEM from page 3 of the menu and press the **ENT** key. The following window appears. The self ID is displayed on the first line.

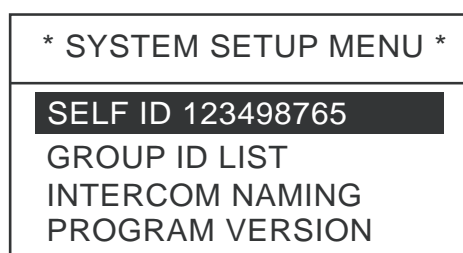

Transceiver unit

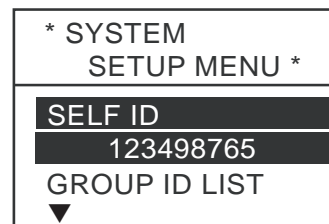

Remote handset

3. Confirm the SELF ID.

5.2 Displaying Group ID LIST

1. Press the **MENU** key.
2. Rotate the **CH** knob (or press up / down arrow key) to choose SYSTEM from page 3 of the menu and press the **ENT** key.
3. Rotate the **CH** knob (or press up / down arrow key) to choose GROUP ID LIST and press the **ENT** key to show the GROUP ID list. For how to registers group IDs, see paragraph 4.5.



5.3 Naming Intercom

1. Press the **MENU** key.
2. Rotate the **CH** knob (or press up / down arrow key) to choose SYSTEM from page 3 of the menu and press the **ENT** key. The following window appears.

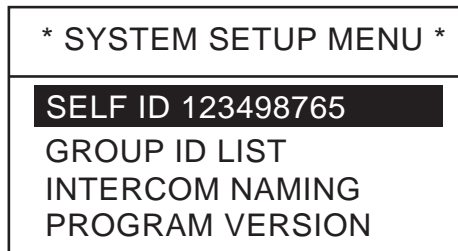

3. Rotate the **CH** knob (or press up / down arrow key) to choose INTERCOM NAMING and press the **ENT** key. The following window appears.

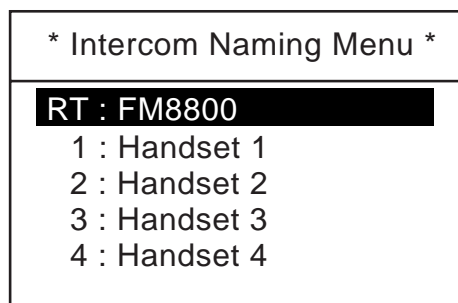

4. Rotate the **CH** knob (or press up / down arrow key) to choose a handset number and press the **ENT** key.
5. Key in remote station name with alphanumeric keys and press the **ENT** key.
6. Repeat steps 4 and 5 to name other handsets.

To change the default name, for example, "1: Handset 1", rotate the CH knob to move the cursor to right of "1".

1: Handset 1_



Move cursor here. And then press the **ENT** key to delete the characters.

Enter a new name for the remote station.

5.4 Displaying Program Version

1. Press the **MENU** key
2. Rotate the **CH** knob to choose the SYSTEM and press the **ENT** key. The following selection window appears.

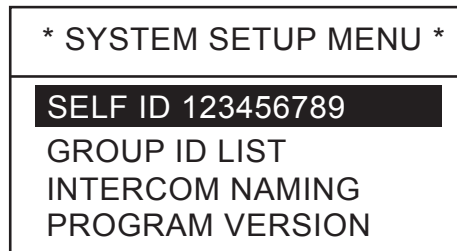

3. Rotate the **CH** knob to choose PROGRAM VERSION and press the **ENT** key to show program version number.

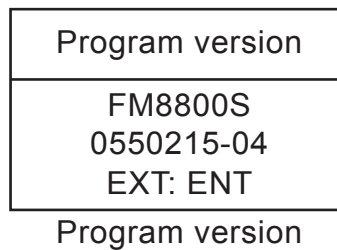

4. Press the **ENT** key to exit.

5. SYSTEM SETUP

This page is intentionally left blank.

6. MAINTENANCE & TROUBLESHOOTING

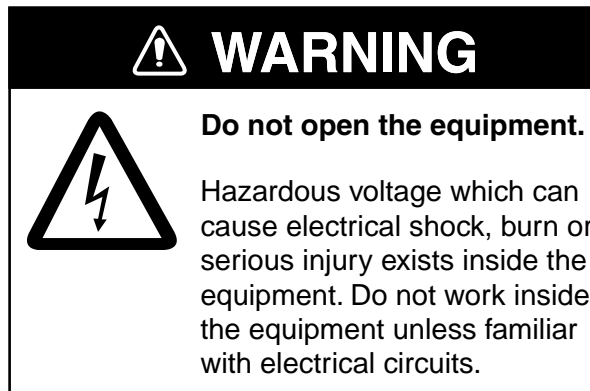

6.1 Maintenance

Periodic checks

- 1) Check that each connector is firmly connected.
- 2) Clean corroded or soiled connectors.
- 3) Check coaxial cable for damage. If damaged, replace.
- 4) Check that bolts fixing the antenna are firmly tightened.

6.2 Troubleshooting

When the power cannot be turned on

- 1) Check if power plug is firmly connected.
- 2) Check fuses in the power cable. If it has tripped, replace it with a new one (15A).
- 3) If power cannot be turned on (after checking 1 and 2), contact a FURUNO agent or representative for advice.

6.3 Daily Test

Authorities require that the DSC be checked daily for proper operation to ensure that it will function properly in the event of distress. Execute the daily test as below.

1. At the standby display, press the **SHIFT** key and **TEST** key in that order. The following display appears for test. And distress alarm (visual and audible) occurs.

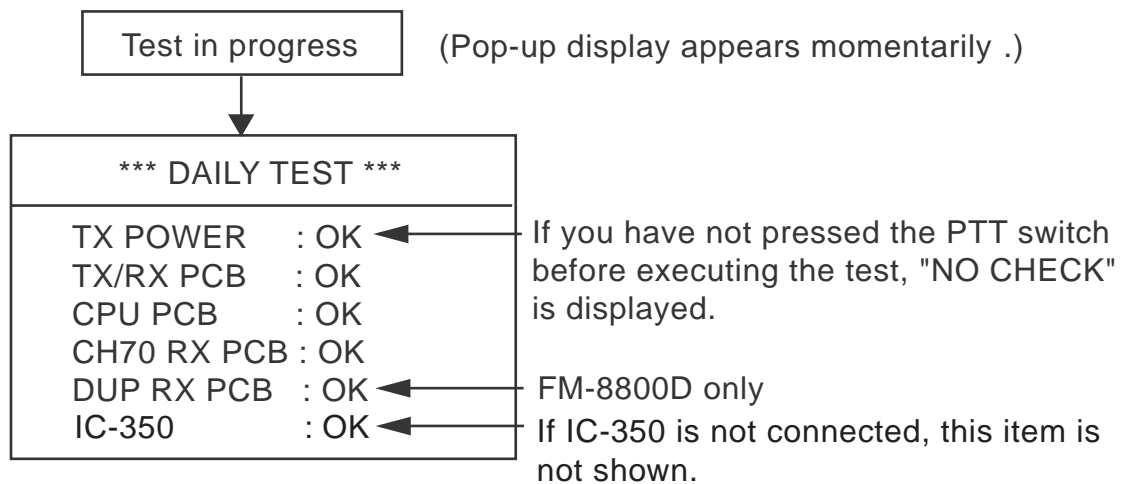

Result of daily test

2. To stop ALARM, press the **CANCEL** key.
3. To stop the daily test, press the **CANCEL** key.

“NG” may be displayed depending on the receiving conditions. In this case, repeat the daily test a couple of times. If NG is displayed always, contact a FURUNO agent or representative for advice.

The table below shows the abnormal indications and causes shown in the daily test.

Indication	Cause
TX POWER: NG	Indicates no transmitting output power. PA module or TX/RX pcb 05P0774 may be damaged.
TX/RX PCB: NG	Indicates abnormal PLL circuit in the TX/RX pcb. TX/RX pcb 05P0774 may be damaged.
CPU PCB: NG	Indicates abnormal loop circuit inside the CPU board. CPU pcb 05P0773 may be damaged.
CH70 RX PCB: NG	Indicates abnormal loop circuit between CPU and CH70 RX pcb. CH70 RX pcb 05P0775 may be damaged.
DUP RX PCB: NG	Indicates abnormal PLL circuit in the DUP RX pcb. DUP RX pcb 05P0777 may be damaged
IC-350: NG	Indicates that the IC-350 has some abnormality.

If necessary, refer to Parts Location on subsequent pages.

6.4 DSC Test Transmission

6.4.1 Transmitting a DSC test message

1. Press the **CALL** key. The display changes from the standby display to the COMPOSE MESSAGE screen and the CALL TYPE is displayed in reverse video.
2. Press the **ENT** key to open the call type list.
3. Rotate the **CH** knob to choose TEST and press the **ENT** key.
4. ID is selected; press the **ENT** key.
5. Key in a ID you want to communicate and press the **ENT** key.

** Compose Message **
<div style="background-color: black; color: white; padding: 2px; margin-bottom: 5px;">CALL TYPE: TEST</div> <p>STATION ID : 987654321 SAFETY KIND : TEST COMM OPTION : NO INFO ACK REQ</p>

6. Press the **CALL** key more than three seconds. A message will be transmitted.

The screen changes as follows.

- a) The timer counts down until you receive ACK.

<div style="border: 1px solid black; padding: 2px; margin-bottom: 5px;">Waiting for acknowledgement.</div> <p>STATION ID : 987654321 SAFETY <div style="background-color: black; color: white; padding: 2px;">KIND : TEST</div> COMM OPTION : NO INFO ACK REQ</p>
TIME TO GO : 3M 30S

6. MAINTENANCE & TROUBLESHOOTING

- b) When the ACK is received, the alarm sounds and the screen changes as follows.

Test acknowledge received.
FROM : 987654321 SAFETY KIND : TEST COMM OPTION : NO INFO ACK
CANCEL ALARM

7. Press the **CANCEL** key to stop the alarm and confirm the message received.

** Received Message **
JAN03/06 11:18 ECC : OK TEST ACK FROM : 987654321 SAFETY KIND : TEST COMM OPTION : NO INFO ACK
PRESS ENT

Note: If the message “No response! Try calling again?” is displayed, press the **ENT** and **CALL** key in order to call again, or press the **CANCEL** key to cancel the calling and return to the standby display.

6.4.2 Receiving a test message

When a test call is received, the alarm sounds. If the manual ACK is set, the following message appears.

<div style="border: 1px solid black; padding: 2px;"> Test request call received. </div>
FROM : 002444888 SAFETY KIND : TEST COMM OPTION : NO INFO ACK REQ
<div style="background-color: black; color: white; padding: 2px; display: inline-block;"> CANCEL ALARM </div>

1. Press the **CANCEL** key to silence the alarm. The following display appears.

** Received Message **
JAN03/06 11:18 ECC : OK TEST CALL FROM : 002444888 SAFETY KIND : TEST COMM OPTION : NO INFO ACK REQ
<div style="background-color: black; color: white; padding: 2px; display: inline-block;"> PRESS ENT TO ACK. </div>

2. Press the **ENT** key.

** Send Message **
TEST ACK TO : 002444888 SAFETY KIND : TEST COMM OPTION : NO INFO ACK
PRESS CALL TO SEND

3. Press the **CALL** key more than three seconds to send the ACK. The screen returns standby display.

6.5 Error Message

The table below shows all the error messages which may appear.

Error message	Meaning
PLL1 Unlock	PLL circuit on the TX/RX pcb 05P0774 has unlocked.
PLL2 Unlock	PLL circuit on the DUP RX pcb 05P0777 has unlocked (only FM-8800D).
ANT ERROR	The antenna is abnormal. In this condition, if the transmission continues more than five seconds, the output power is reduced to approximately 10W.
EPFS ERROR	There is no L/L input from a positioning sensor for more than ten minutes.
System Error	The DSP (digital signal processor) is abnormally.
Printer PE	Printer is disconnected or paper runs out.

6.6 Parts Location

Transceiver unit FM-8800D/8800S

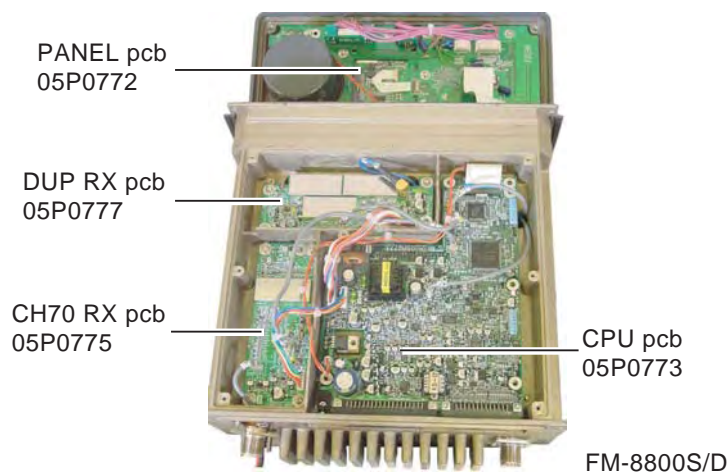
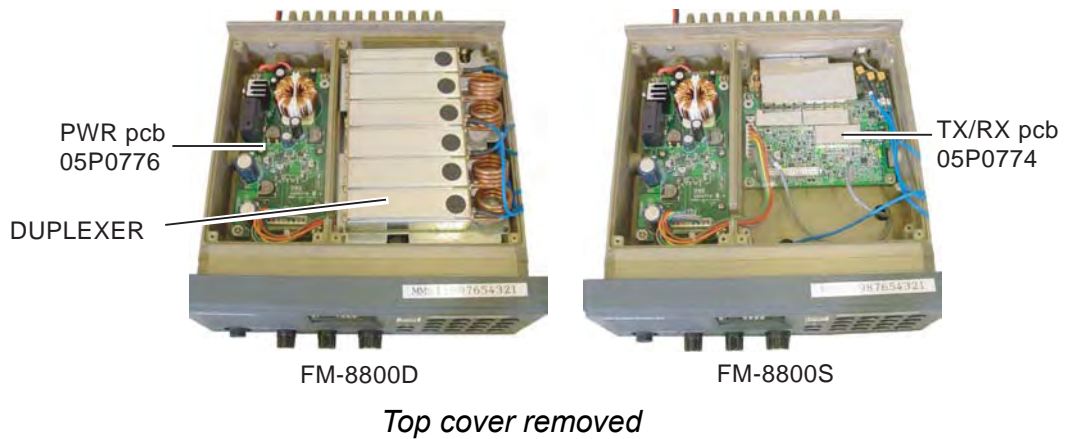

6. MAINTENANCE & TROUBLESHOOTING



Bottom cover removed

Handset HS-2003

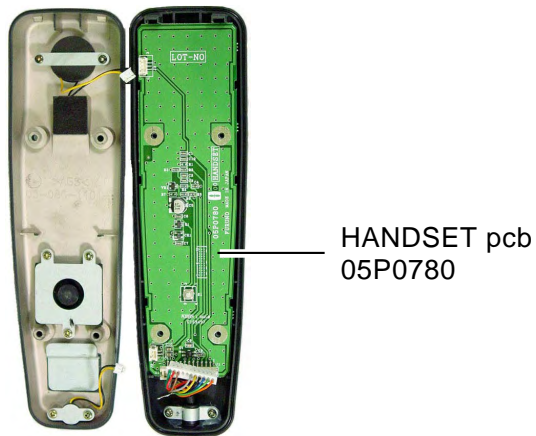

Remote station RB-8800/RB-8810/ RB-8810-W/HS-8800/ HS-8800-W

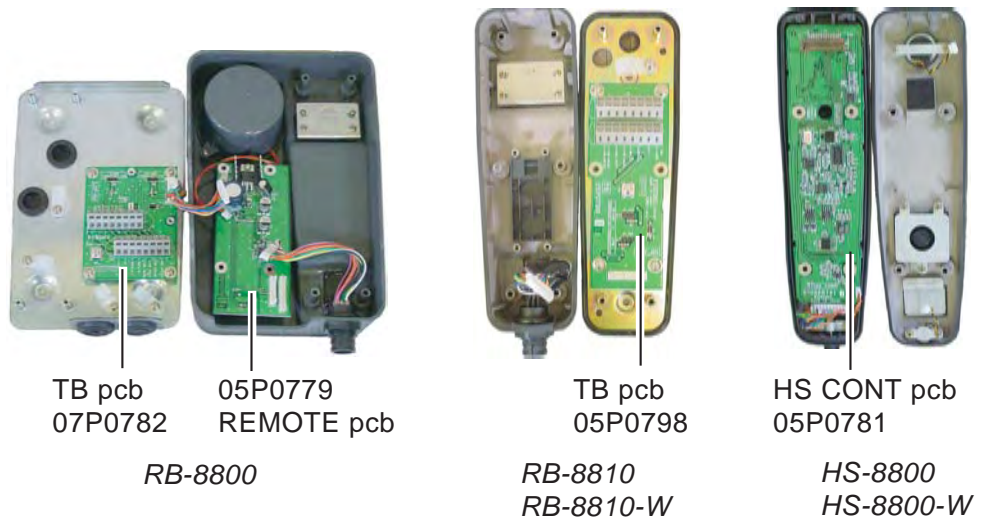

TB pcb 07P0782
05P0779
REMOTE pcb

RB-8800

TB pcb 05P0798

*RB-8810
RB-8810-W*

HS CONT pcb 05P0781

*HS-8800
HS-8800-W*

6. MAINTENANCE & TROUBLESHOOTING

Junction box IF-8810

JUNCTION pcb
05P0790

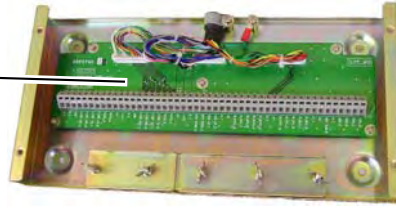

DMC Interface IF-8820

DMC IF pcb
05P0778



APPENDIX

Menu Tree

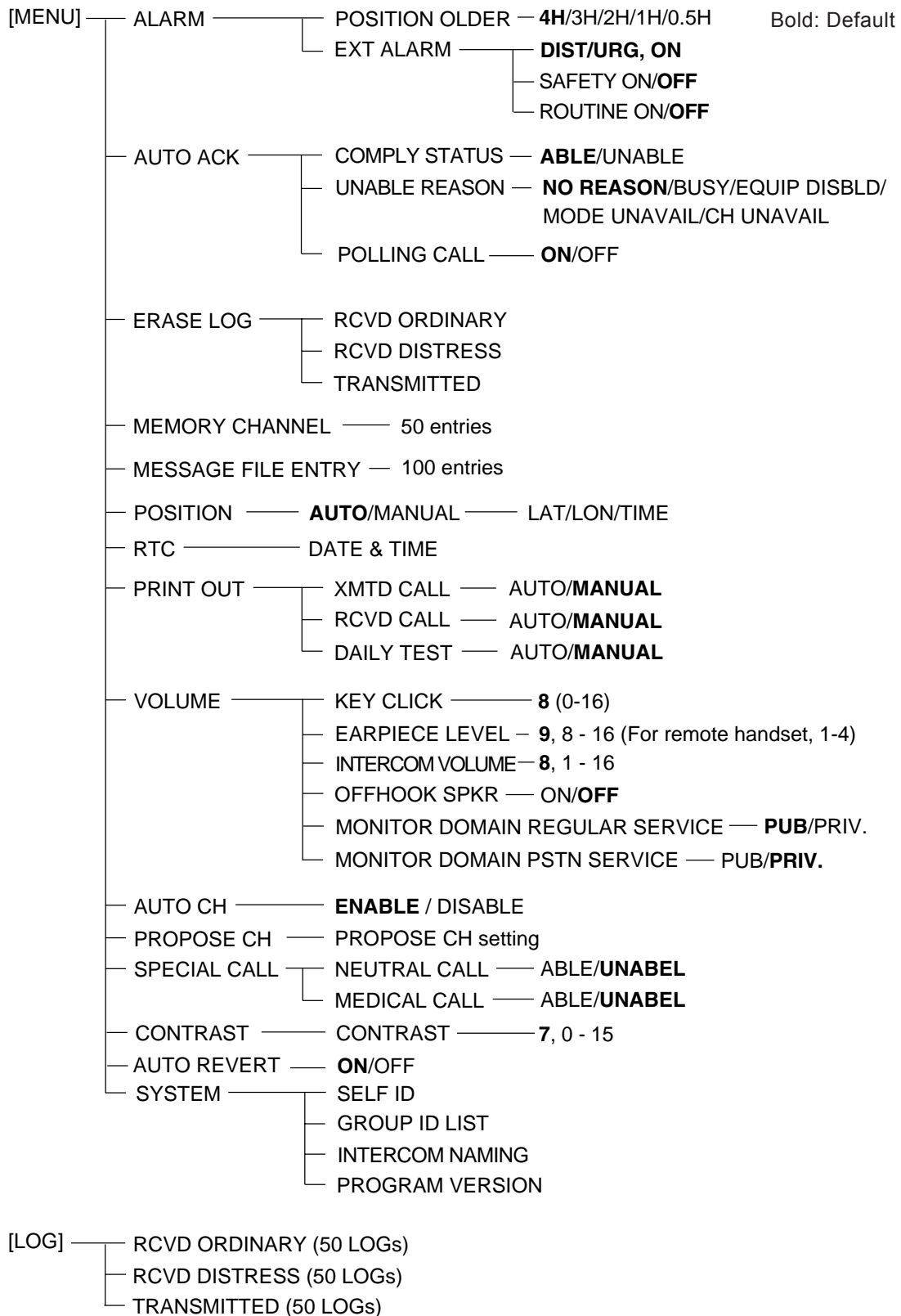

APPENDIX

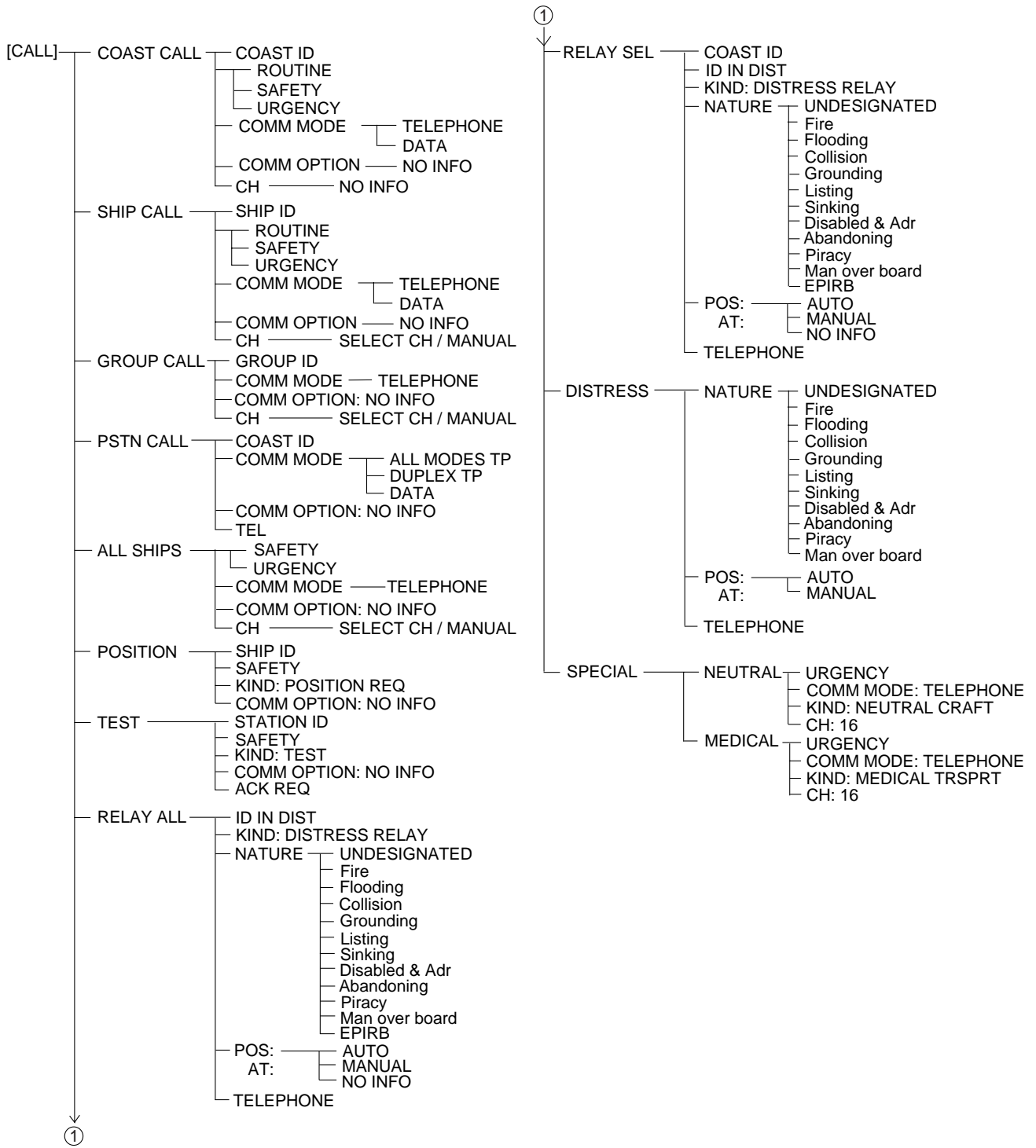

Marine VHF Channel Lists

1) International Channels

CH	TX MHz	RX MHz	Remark	CH	TX MHz	RX MHz	Remark
01	156.050	160.650		60	156.025	160.625	
02	156.100	160.700		61	156.075	160.675	
03	156.150	160.750		62	156.125	160.725	
04	156.200	160.800		63	156.175	160.775	
05	156.250	160.850		64	156.225	160.825	
06	156.300	156.300		65	156.275	160.875	
07	156.350	160.950		66	156.325	160.925	
08	156.400	156.400		67	156.375	156.375	
09	156.450	156.450		68	156.425	156.425	
10	156.500	156.500		69	156.475	156.475	
11	156.550	156.550		70	-	156.525	DSC
12	156.600	156.600		71	156.575	156.575	
13	156.650	156.650		72	156.625	156.625	
14	156.700	156.700		73	156.675	156.675	
15	156.750	156.750	Low PWR	74	156.725	156.725	
16	156.800	156.800		75	156.775	156.775	Low PWR
17	156.850	156.850	Low PWR	76	156.825	156.825	Low PWR
18	156.900	161.500		77	156.875	156.875	
19	156.950	161.550		78	156.925	161.525	
20	157.000	161.600		79	156.975	161.575	
21	157.050	161.650		80	157.025	161.625	
22	157.100	161.700		81	157.075	161.675	
23	157.150	161.750		82	157.125	161.725	
24	157.200	161.800		83	157.175	161.775	
25	157.250	161.850		84	157.225	161.825	
26	157.300	161.900		85	157.275	161.875	
27	157.350	161.950		86	157.325	161.925	
28	157.400	162.000		87	157.375	157.375	
				88	157.425	157.425	

APPENDIX

2) USA Channels

CH	TX MHz	RX MHz	Remark	CH	TX MHz	RX MHz	Remark
01	156.050	156.050		60	-	-	
02	-	-		61	-	-	
03	-	-		62	-	-	
04	-	-		63	156.175	156.175	
05	156.250	156.250		64	-	-	
06	156.300	156.300		65	156.275	156.275	
07	156.350	156.350		66	156.325	156.325	
08	156.400	156.400		67	156.375	156.375	Low PWR
09	156.450	156.450		68	156.425	156.425	
10	156.500	156.500		69	156.475	156.475	
11	156.550	156.550		70	-	156.525	DSC
12	156.600	156.600		71	156.575	156.575	
13	156.650	156.650	Low PWR	72	156.625	156.625	
14	156.700	156.700		73	156.675	156.675	
15	-	156.750		74	156.725	156.725	
16	156.800	156.800		75	-	-	
17	156.850	156.850	Low PWR	76	-	-	
18	156.900	156.900		77	156.875	156.875	Low PWR
19	156.950	156.950		78	156.925	156.925	
20	157.000	157.000		79	156.975	156.975	
21	157.050	157.050		80	157.025	157.025	
22	157.100	157.100		81	157.075	157.075	
23	157.150	157.150		82	157.125	157.125	
24	157.200	161.800		83	157.175	157.175	
25	157.250	161.850		84	157.225	161.825	
26	157.300	161.900		85	157.275	161.875	
27	157.350	161.950		86	157.325	161.925	
28	157.400	162.000		87	157.375	157.375	
				88	157.425	157.425	

US Weather Channels

WX	RX MHz	WX	RX MHz
01	162.550	06	162.500
02	162.400	07	162.525
03	162.475	08	161.650
04	162.425	09	161.775
05	162.450	10	163.275

3) Canadian Channels

CH	TX MHz	RX MHz	Remark	CH	TX MHz	RX MHz	Remark
01	156.050	160.650		60	156.025	160.625	
02	156.100	160.700		61	156.075	156.075	
03	156.150	160.750		62	156.125	156.125	
04	156.200	156.200		63			
05	156.250	156.250		64	156.225	156.225	
06	156.300	156.300		65	156.275	156.275	Low PWR
07	156.350	156.350		66	156.325	156.325	
08	156.400	156.400		67	156.375	156.375	
09	156.450	156.450		68	156.425	156.425	
10	156.500	156.500		69	156.475	156.475	
11	156.550	156.550		70	-	156.525	DSC
12	156.600	156.600		71	156.575	156.575	
13	156.650	156.650		72	156.625	156.625	
14	156.700	156.700		73	156.675	156.675	
15	156.750	156.750	Low PWR	74	156.725	156.725	
16	156.800	156.800		75	-	-	
17	156.850	156.850	Low PWR	76	-	-	
18	156.900	156.900		77	156.875	156.875	Low PWR
19	156.950	156.950		78	156.925	156.925	
20	157.000	161.600	Low PWR	79	156.975	156.975	
21	157.050	157.050		80	157.025	157.025	
22	157.100	157.100		81	157.075	157.075	
23	157.150	161.750		82	157.125	157.125	
24	157.200	161.800		83	157.175	157.175	
25	157.250	161.850		84	157.225	161.825	
26	157.300	161.900		85	157.275	161.875	
27	157.350	161.950		86	157.325	161.925	
28	157.400	162.000		87	157.375	157.375	
				88	157.425	157.425	

APPENDIX

4) Inland waterways (INLND-W) Channels

CH	TX MHz	RX MHz	Remark	CH	TX MHz	RX MHz	Remark
01	156.050	160.650		60	156.025	160.625	
02	156.100	160.700		61	156.075	160.675	
03	156.150	160.750		62	156.125	160.725	
04	156.200	160.800		63	156.175	160.775	
05	156.250	160.850		64	156.225	160.825	
06	156.300	156.300	Low PWR	65	156.275	160.875	
07	156.350	160.950		66	156.325	160.925	
08	156.400	156.400	Low PWR	67	156.375	156.375	
09	156.450	156.450		68	156.425	156.425	
10	156.500	156.500	Low PWR	69	156.475	156.475	
11	156.550	156.550	Low PWR	70	-	156.525	DSC
12	156.600	156.600	Low PWR	71	156.575	156.575	Low PWR
13	156.650	156.650	Low PWR	72	156.625	156.625	Low PWR
14	156.700	156.700	Low PWR	73	156.675	156.675	
15	156.750	156.750	Low PWR	74	156.725	156.725	Low PWR
16	156.800	156.800		75	-	-	
17	156.850	156.850	Low PWR	76	-	-	
18	156.900	161.500		77	156.875	156.875	Low PWR
19	156.950	161.550		78	156.925	161.525	
20	157.000	161.600		79	156.975	161.575	
21	157.050	161.650		80	157.025	161.625	
22	157.100	161.700		81	157.075	161.675	
23	157.150	161.750		82	157.125	161.725	
24	157.200	161.800		83	157.175	161.775	
25	157.250	161.850		84	157.225	161.825	
26	157.300	161.900		85	157.275	161.875	
27	157.350	161.950		86	157.325	161.925	
28	157.400	162.000		87	157.375	157.375	
				88	157.425	157.425	

5) Private Channels

TX	RX		CH NO (current)	Remark
	Simplex	Semi-dup		
155.000	155.000	159.600	180	
155.025	155.025	159.625	181	
155.050	155.050	159.650	182	
155.075	155.075	159.675	183	
155.100	155.100	159.700	184	
155.125	155.125	159.725	185	
155.150	155.150	159.750	186	
155.175	155.175	159.775	187	
155.200	155.200	159.800	188	
155.225	155.225	159.825	189	
155.250	155.250	159.850	190	
155.275	155.275	159.875	191	
155.300	155.300	159.900	192	
155.325	155.325	159.925	193	
155.350	155.350	159.950	194	
155.375	155.375	159.975	195	
155.400	155.400	160.000	196	
155.425	155.425	160.025	197	
155.450	155.450	160.050	198	
155.475	155.475	160.075	199	
155.500	155.500	160.100	120(L1)	
155.525	155.525	160.125	121(L2)	
155.550	155.550	160.150	122	
155.575	155.575	160.175	123	
155.600	155.600	160.200	124	
155.625	155.625	160.225	125(F1)(P1)	
155.650	155.650	160.250	126(L3)	
155.675	155.675	160.275	127	
155.700	155.700	160.300	128	
155.725	155.725	160.325	129	
155.750	155.750	160.350	130	
155.775	155.775	160.375	131(F2)(P2)	
155.800	155.800	160.400	132	
155.825	155.825	160.425	133(F3)(P3)	
155.850	155.850	160.450	134	
155.875	155.875	160.475	135	
155.900	155.900	160.500	136	
155.925	155.925	160.525	137	
155.950	155.950	160.550	138	

- Continued -

-

APPENDIX

TX	RX		CH NO (current)	Remark
	Simplex	Semi-dup		
155.975	155.975	160.575	139	
156.000	156.000	160.600	00	Min DUPch
156.025	156.025	160.625	60	
156.050	156.050	160.650	01	
156.075	156.075	160.675	61	
156.100	156.100	160.700	02	
156.125	156.125	160.725	62	
156.150	156.150	160.750	03	
156.175	156.175	160.775	63	
156.200	156.200	160.800	04	
156.225	156.225	160.825	64	
156.250	156.250	160.850	05	
156.275	156.275	160.875	65	
156.300	156.300	160.900	06	
156.325	156.325	160.925	66	
156.350	156.350	160.950	07	
156.375	156.375	160.975	67	
156.400	156.400	161.000	08	
156.425	156.425	161.025	68	
156.450	156.450	161.050	09	
156.475	156.475	161.075	69	
156.500	156.500	161.100	10	
156.525	156.525	161.125	70	
156.550	156.550	161.150	11	
156.575	156.575	161.175	71	
156.600	156.600	161.200	12	
156.625	156.625	161.225	72	
156.650	156.650	161.250	13	
156.675	156.675	161.275	73	
156.700	156.700	161.300	14	
156.725	156.725	161.325	74	
156.750	156.750	161.350	15	
156.775	156.775	161.375	75	
156.800	156.800	161.400	16	
156.825	156.825	161.425	76	
156.850	156.850	161.450	17	
156.875	156.875	161.475	77	
156.900	156.900	161.500	18	
156.925	156.925	161.525	78	
156.950	156.950	161.550	19	

- Continued -

TX	RX		CH NO (current)	Remark
	Simplex	Semi-dup		
156.975	156.975	161.575	79	
157.000	157.000	161.600	20	
157.025	157.025	161.625	80	
157.050	157.050	161.650	21	
157.075	157.075	161.675	81	
157.100	157.100	161.700	22	
157.125	157.125	161.725	82	
157.150	157.150	161.750	23	
157.175	157.175	161.775	83	
157.200	157.200	161.800	24	
157.225	157.225	161.825	84	
157.250	157.250	161.850	25	
157.275	157.275	161.875	85	
157.300	157.300	161.900	26	
157.325	157.325	161.925	86	
157.350	157.350	161.950	27	
157.375	157.375	161.975	87	
157.400	157.400	162.000	28	
157.425	157.425	162.025	88	
157.450	157.450	162.050	29	
157.475	157.475	162.075	89	
157.500	157.500	162.100	30	Max DUPch
157.525	157.525	162.125	90	
157.550	157.550	162.150	31	
157.575	157.575	162.175	91	
157.600	157.600	162.200	32	
157.625	157.625	162.225	92	
157.650	157.650	162.250	33	
157.675	157.675	162.275	93	
157.700	157.700	162.300	34	
157.725	157.725	162.325	94	
157.750	157.750	162.350	35	
157.775	157.775	162.375	95	
157.800	157.800	162.400	36	
157.825	157.825	162.425	96	
157.850	157.850	162.450	37	
157.875	157.875	162.475	97	
157.900	157.900	162.500	38	
157.925	157.925	162.525	98	
157.950	157.950	162.550	39	

- Continued -

-

APPENDIX

TX	RX		CH NO (current)	Remark
	Simplex	Semi-dup		
157.975	157.975	162.575	99	
158.000	158.000	162.600	40	
158.025	158.025	162.625	100	
158.050	158.050	162.650	41	
158.075	158.075	162.675	101	
158.100	158.100	162.700	42	
158.125	158.125	162.725	102	
158.150	158.150	162.750	43	
158.175	158.175	162.775	103	
158.200	158.200	162.800	44	
158.225	158.225	162.825	104	
158.250	158.250	162.850	45	
158.275	158.275	162.875	105	
158.300	158.300	162.900	46	
158.325	158.325	162.925	106	
158.350	158.350	162.950	47	
158.375	158.375	162.975	107	
158.400	158.400	163.000	48	
158.425	158.425	163.025	108	
158.450	158.450	163.050	49	
158.475	158.475	163.075	109	
158.500	158.500	163.100	50	
158.525	158.525	163.125	110	
158.550	158.550	163.150	51	
158.575	158.575	163.175	111	
158.600	158.600	163.200	52	
158.625	158.625	163.225	112	
158.650	158.650	163.250	53	
158.675	158.675	163.275	113	
158.700	158.700	163.300	54	
158.725	158.725	163.325	114	
158.750	158.750	163.350	55	
158.775	158.775	163.375	115	
158.800	158.800	163.400	56	
158.825	158.825	163.425	116	
158.850	158.850	163.450	57	
158.875	158.875	163.475	117	
158.900	158.900	163.500	58	
158.925	158.925	163.525	118	
158.950	158.950	163.550	59	

- Continued -

-

TX	RX		CH NO (current)	Remark
	Simplex	Semi-dup		
158.975	158.975	163.575	119	
159.000	159.000	163.600	200	RX.max.freq
159.025	159.025		201	
159.050	159.050		202	
159.075	159.075		203	
159.100	159.100		204	
159.125	159.125		205	
159.150	159.150		206	
159.175	159.175		207	
159.200	159.200		208	
159.225	159.225		209	
159.250	159.250		210	
159.275	159.275		211	
159.300	159.300		212	
159.325	159.325		213	
159.350	159.350		214	
159.375	159.375		215	
159.400	159.400		216	
159.425	159.425		217	
159.450	159.450		218	
159.475	159.475		219	
159.500	159.500		220	
159.525	159.525		221	
159.550	159.550		222	
159.575	159.575		223	
159.600	159.600		224	
159.625	159.625		225	
159.650	159.650		226	
159.675	159.675		227	
159.700	159.700		228	
159.725	159.725		229	
159.750	159.750		230	
159.775	159.775		231	
159.800	159.800		232	
159.825	159.825		233	
159.850	159.850		234	
159.875	159.875		235	
159.900	159.900		236	
159.925	159.925		237	
159.950	159.950		238	

- Continued -

-

APPENDIX

TX	RX		CH NO (current)	Remark
	Simplex	Semi-dup		
159.975	159.975		239	
160.000	160.000		240	
160.025	160.025		241	
160.050	160.050		242	
160.075	160.075		243	
160.100	160.100		244	
160.125	160.125		245	
160.150	160.150		246	
160.175	160.175		247	
160.200	160.200		248	
160.225	160.225		249	
160.250	160.250		250	
160.275	160.275		251	
160.300	160.300		252	
160.325	160.325		253	
160.350	160.350		254	
160.375	160.375		255	
160.400	160.400		256	Added ch no.
160.425	160.425		257	Added ch no.
160.450	160.450		258	Added ch no.
160.475	160.475		259	Added ch no.
160.500	160.500		140	
160.525	160.525		141	
160.550	160.550		142	
160.575	160.575		143	
160.600	160.600		144	
160.625	160.625		145	
160.650	160.650		146	
160.675	160.675		147	
160.700	160.700		148	
160.725	160.725		149	
160.750	160.750		150	
160.775	160.775		151	
160.800	160.800		152	
160.825	160.825		153	
160.850	160.850		154	
160.875	160.875		155	
160.900	160.900		156	
160.925	160.925		157	
160.950	160.950		158	

- Continued -

-

TX	RX		CH NO (current)	Remark
	Simplex	Semi-dup		
160.975	160.975		159	
161.000	161.000		160	
161.025	161.025		161	
161.050	161.050		162	
161.075	161.075		163	
161.100	161.100		164	
161.125	161.125		165	
161.150	161.150		166	
161.175	161.175		167	
161.200	161.200		168	
161.225	161.225		169	
161.250	161.250		170	
161.275	161.275		171	
161.300	161.300		172	
161.325	161.325		173	
161.350	161.350		174	
161.375	161.375		175	
161.400	161.400		176	
161.425	161.425		177(M2)	
161.450	161.450		178	
161.475	161.475		179	

Digital Interface (IEC 61162-1 Edition 2)

Input sentences

GGA, GLL, RMC, ZDA, GNS

Schematic diagram

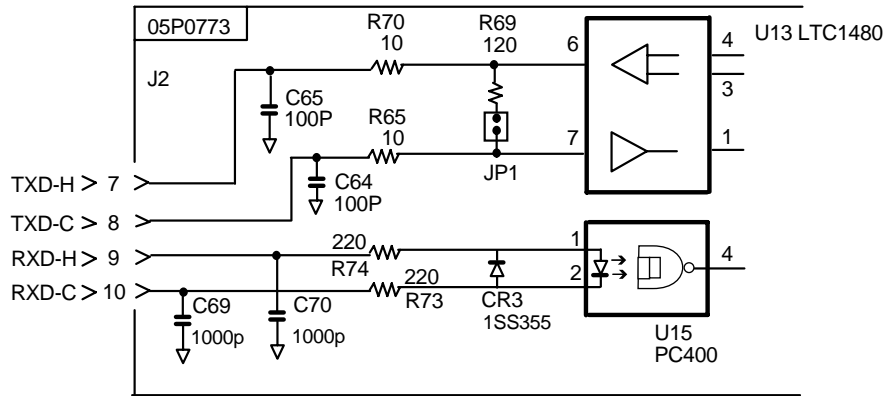

Load requirements as listner

Isolation	Optocoupler
Input impedance	560 ohms
Max. Voltage	±15V
Threshold	4 mA

Output sentence

TLL

GGA - Global positioning system (GPS) fix data

```
$--GGA,hhmmss.ss,llll.lll,a,yyyyy.yyy,a,x,xx,x.x,x.x,M,x.x,M,x.x,xxxx*hh<CR><LF>
```

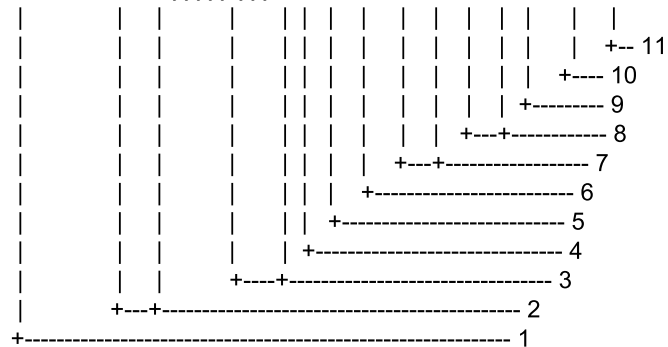

1. UTC of position
2. Latitude, N/S
3. Longitude, E/W
4. GPS quality indicator (see note)
5. Number of satellite in use,00-12, may be different from the number in view
6. Horizontal dilution of precision
7. Antenna altitude above/below mean sealevel, m
8. Geoidal separation, m
9. Age of differential GPS data
10. Differential reference station ID, 0000-1023
11. Checksum

NOTE

- 0 = fix not available or invalid
 - 1 = GPS SPS mode, fix valid
 - 2 = differential GPS, SPS mode, fix valid
 - 3 = GPS PPS mode, fix valid
 - 4 = Real Time Kinetic. Satellite system used in RTK mode with fixed integers
 - 5 = Float RTK. Satellite system used in RTK mode with floating fingers
 - 6 = Estimated (dead reckoning) mode
 - 7 = Manual input mode
 - 8 = Simulator mode
- The GPS quality indicator shall not be a null field.

RMC - Recommended minimum specific GPS/TRANSIT data

\$--RMC,hhmmss.ss,A,lll.lll,a,yyyyy.yyy,a,x.x,x.x,xxxxxx,x.x,a,a*hh<CR><LF>

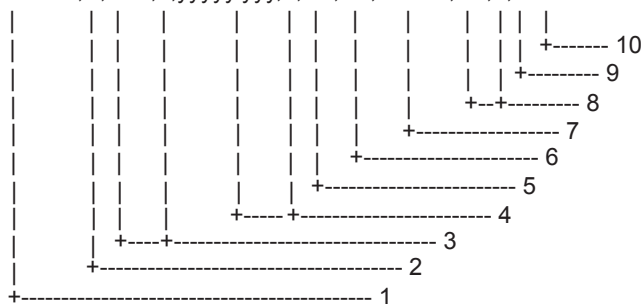

1. UTC of position fix
2. Status: A=data valid, V=navigation receiver warming
3. Latitude, N/S
4. Longitude, E/W
5. Speed over ground, knots
6. Course over ground, degrees true
7. Date: dd/mm/yy
8. Magnetic variation, degree E/W
9. Mode indicator(see note)
10. Checksum

NOTE Positioning system Mode indicator:

- A=Autonomous
- D=Differential
- E = Estimated (dead reckoning)
- M = Manual input
- S= Simulator
- N=Data not valid

The Mode indicator field supplements the Status field. The Status field shall be set to V=invalid for all values of Operating Mode except for A=Autonomous and D=Differential. The positioning system Mode indicator and Status field shall not be null fields.

ZDA - Time and data

\$--ZDA,hhmmss.ss,xx,xx,xxxx,xx,xx*hh<CR><LF>

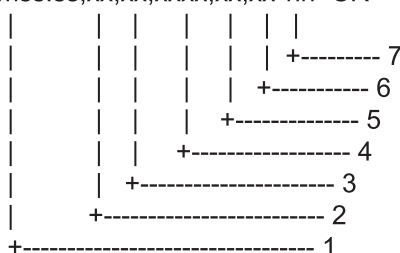

1. UTC
2. Day, 01 to 31(UTC)
3. Month, 01 to 12(UTC)
4. Year(UTC)
5. Local zone hours, 00h to +-13h
6. Local zone minutes, 00 to +59
as local hours
7. Checksum

TLL – Target latitude and longitude

\$--TLL,xx,III.III,a,yyyyy.yyy,a,c--c,hhmmss.ss,a,a*hh<CR><LF>

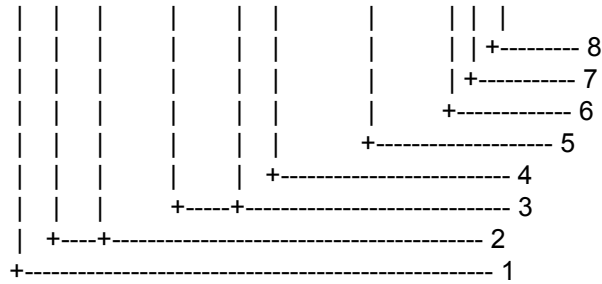

1. Target number 00 - 99
- 2. Latitude, N/S**
- 3. Longitude, E/W**
4. Target name
5. UTC of data
6. Target status(see note)
7. Reference target=R,null otherwise
8. Checksum

NOTE - Target status

- L = lost, tracked target has beenlost
- Q = query, target in the process of acquisition
- T = tracking

Thermal Printer UTP-80FK

1. Printer usage cautions

- Do not disassemble or attempt to repair the printer.
- Do not allow water to enter the printer.
- Do not drop or jar the printer.
- Fix a paper jam after turning off the power.
- Turn off the power when there is some problem (for example, strange smell or smoke), and confirm that the trouble is not continuous.

2. Paper usage cautions

The surface of the thermal paper is coated with special chemicals and the characters are printed out by thermochemical reaction.

- Use specified thermal roll paper.
- Keep in a cool, dry place.
- Keep paper away from hard objects, solvents and vinyl film to prevent paper discoloration.
- Use water-based glue (starch glue, synthetic glue, etc.) when pasting thermal paper.
- Adhesive tape can discolor the thermal paper. Use double-sided tape on the reverse side of the paper.
- Do not touch the paper with wet hands. Fingerprints may appear on the recording or the recording may become blurred.

3. Specifications, Parts of the Printer

Specifications

1. Thermal roll paper

Paper type: P-80-25 (Code NO. 000-805-780)

Width of paper: 80 mm

External diameter of roll paper: ϕ 48mm

Length of paper: 25m

2. Environmental conditions

Useable temperature: 0 to +50°C

Storage temperature: -20 to +60°C

Useable and storage humidity: 35 to 85% (no condensation)

Parts

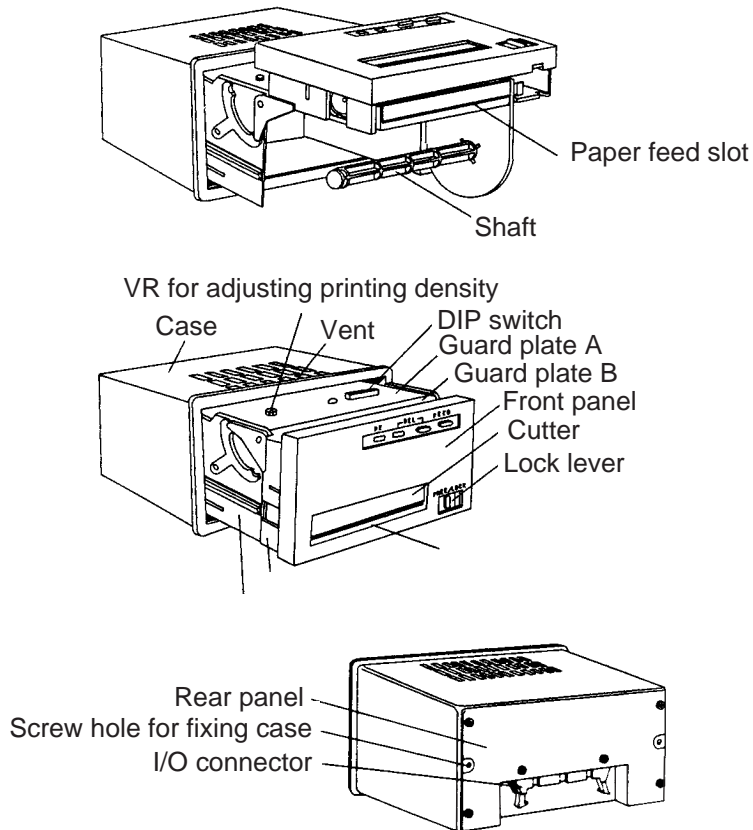

4. Operation

Loading roll paper

- 1) Unlocking the Slide lock

Slide the Lock lever at the right bottom of the panel to the FREE position to unlock the front panel ①.

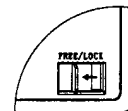

- 2) Pushing the panel

Push the center of the front panel about 2 mm inward. Release, and panel pops out by about 10mm ②.

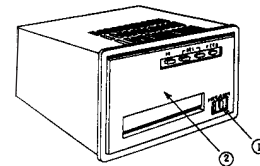

- 3) Pulling out the panel

Place thumb and index finger at top and bottom of panel and pull the panel forward until you feel some resistance.

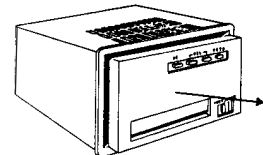

- 4) Pulling the panel upward

Pull the panel upward. When you hear a click, continue pulling the panel upward to 90° until you hear a click again.

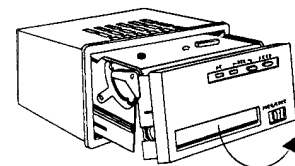

5) Attaching roll paper

Insert roll paper into the shaft.

NOTE) Insert the paper so it feeds from above as shown in the figure at right.

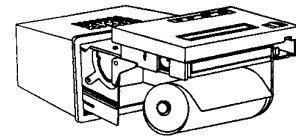

6) Inserting paper

Turn on the POWER and confirm that the PE LED lights red. Insert paper through paper feed slot. The PE LED goes off then paper is fed. Feeding stops after the paper is fed a certain amount.

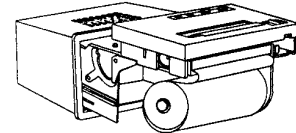

7) Pulling down the panel

After setting paper, pull the bottom of the panel downward to fix the panel. Confirm that a click sounds.

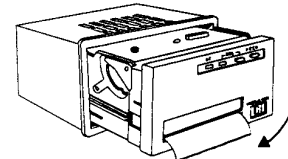

8) Pushing in the panel

Place thumb and index finger at bottom and top of panel and push in the panel.

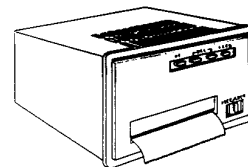

9) Locking the panel

Push the center of the panel inside the case until it is deeper than the frame. The front panel should be flush with the frame.

10) Locking the Slide lock

Slide the Lock lever to the LOCK position to lock the panel.

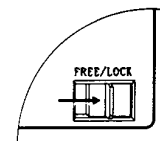

Front panel

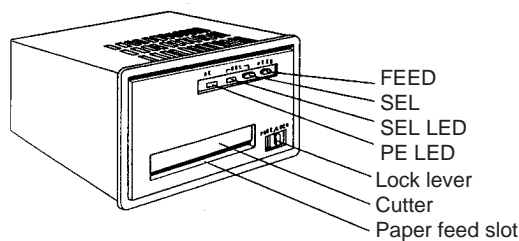

- PE LED: Lights when paper is out.
- SEL LED: Lights in ON-LINE condition.
Data can be received when the light is ON.
- SEL: Chooses ON-LINE or OFF-LINE, alternately.
To temporarily stop printing use this switch to choose OFF-LINE (SEL LED goes OFF). Push the switch again to re-start printing.
FEED is available on OFF-LINE.
- FEED: Feeds out paper continuously when equipment is in OFF-LINE condition.
This switch also executes the printing test – while pressing down the switch, turn on the power.

APPENDIX

- Lock lever: Locks the front panel. The LOCK position prevents opening of the front panel.
- Cutter: Cuts paper. Pull up the paper to cut it.
- Paper feed slot: Feeds paper.

Setting the DIP switch

The DIP switch at the top of the frame functions to change printer specifications. Default specifications are shown in the table below.

TABLE1 Setting DIP switch

Function	1	2	3	4	5	6	7	8	9	10
Small characters	ON									No use
Normal character	OFF									
Inverted printing		ON								
Upright printing		OFF								
22 digits printing			ON							
20 digits printing			OFF							
International characters				Ref. TABLE 2						
Printer mechanism compensation							Ref. TABLE 3			
Auto line feed									ON	

TABLE 2 International characters

Function	4	5	6
Japan	OFF	OFF	OFF
United States	OFF	OFF	ON
Germany	OFF	ON	OFF
England	OFF	ON	ON
France	ON	OFF	OFF
Spain	ON	OFF	ON
Italy	ON	ON	OFF
Sweden	ON	ON	ON

TABLE 3 Printer mechanism compensation

The left and right printing positions may vary over the course of a voyage. Printing position is adjusted at the factory, however friction, etc. may cause misalignment. If misalignment occurs, adjust printing position.

Addition to standard α	7	8
0	OFF	OFF
-1	OFF	ON
+1	ON	OFF
+2	ON	ON

4) Removing jammed paper

- a) Remove paper carefully from the paper feed slot.
- b) If torn paper cannot be removed with fingers use a tweezers, being careful not to scratch parts.

NOTE) Scratched printing head, platen or rubber roller can cause printing or paper feed malfunction.

- c) If torn paper cannot be removed, consult a FURUNO dealer for advice.

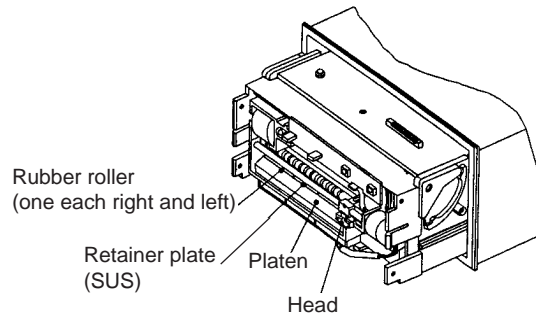

5) Setting paper

Set paper as mentioned earlier.

5. Adjusting printing intensity

You can adjust the printing intensity with the control at the top of the frame.

Clockwise: Lessens intensity.

Counterclockwise: Increases intensity.

Thermal Printer UTP-58E

For general operation notice, see Thermal printer UTP-80FK.

UTP-58E for RC-8800S/D-B (Rack Console) and PP-8800A (Printer)

Push the POWER switch and the POWER Lamp goes on. When the lamp is on data received from the radiotelephone is printed. After completion of printing, feed paper out by pressing the LINE FEED button.

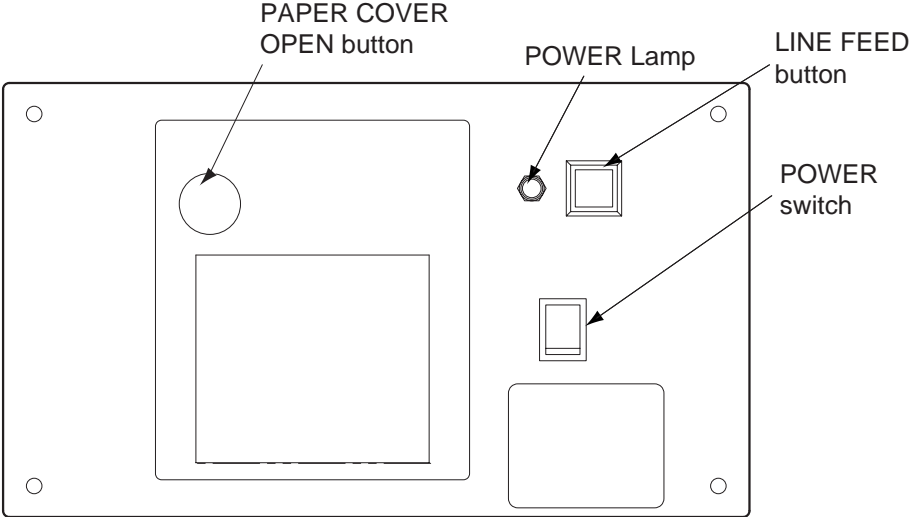

Paper replacement

Paper: type TP058-30CL, code number 000-154-047-10

1. Push the PAPER COVER OPEN button to open the paper cover.
2. Load the roll paper as shown below.
3. Set the roll paper so that the end of paper is outside the printer, and then close the cover by pressing both sides of the top of the paper cover.

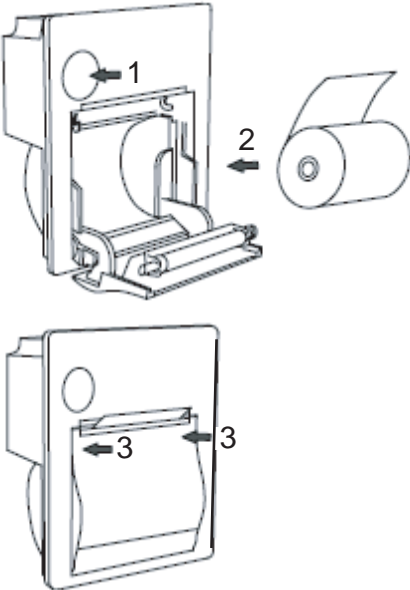

This page is intentionally left blank.

SPECIFICATIONS OF MARINE VHF RADIOTELEPHONE FM-8800D/FM-8800S

1. GENERAL

- | | | |
|--------------------------|---|---|
| (1) Number of Channels | INTL: 57
USA: 55 (57)*
Weather: 10
Canada: 55 (57)*
INLND-W: 55 (57)*
Private: 20
MEMORY CH: 50 | *: CH75&76 can be included
for some countries. |
| (2) Frequency Stability | Within ± 1.5 kHz | |
| (3) Communication System | FM-8800S: Simplex/Semi-duplex
FM-8800D: Simplex/Full-duplex | |
| (4) Class of Emission | 16K0G3E (Voice)
16K0G2B (DSC) | |
| (5) Antenna Impedance | 50 ohms | |

2. TRANSMITTER

(1) Frequency Range

FM-8800S	Simplex	155.000 to 161.475 MHz
	Semi-duplex	155.000 to 161.475 MHz
FM-8800D	Simplex	155.000 to 158.000 MHz
	Full-duplex	155.000 to 158.000 MHz

- | | |
|-------------------------|-----------------------------------|
| (2) Output Power | 25 W max., 1 W at power reduction |
| (3) Frequency Deviation | ≤ 5 kHz |

3. RECEIVER

(1) Frequency Range

FM-8800S	Simplex	155.000 to 159.600 MHz
	Semi-duplex	161.475 to 164.200 MHz
FM-8800D	Simplex	155.000 to 158.000 MHz
	Full-duplex	160.625 to 162.600 MHz

- | | |
|----------------------------------|--|
| (2) Receiving System | Double Superheterodyne |
| (3) Intermediate Frequency | 1st: 51.2375 MHz, 2nd: 37.5 kHz |
| (4) Sensitivity | +6 dB μ V (20 dB SINAD) |
| (5) Adjacent Channel Selectivity | 70 dB or more |
| (6) Spurious Response | 70 dB or more |
| (7) AF Output | Built-in Speaker: 3 W (4 ohms)
Handset earphone: 2mW (150 ohms) |

4. DSC

- | | |
|---------------------|--|
| (1) Protocol | ITU-R Rec. 541-9, 493-11 (class A) and 689-2 |
| (2) Baud Rate | 1200 baud ± 30 ppm max. |
| (3) Modulation | AFSK |
| (4) Frequency Shift | 1700 ± 400 Hz
Mark: 1300 Hz, Space: 2100 Hz |

5. CH70 WATCH RECEIVER

- (1) Receiving Frequency 156.525 MHz
- (2) Sensitivity Symbol error rate: Less than 1% (at 0 dBμV)
- (3) Conducted Spurious Emission Less than 2 nW

6. POWER REQUIREMENTS

- (1) Power Supply 24 VDC (-10%/+30%)
- (2) Power Consumption

FM-8800S	Waiting	0.5 A
	Receive	1.6 A at 4 W audio output
	Transmit	1.6 A at 1 W output, 4.7 A at 25 W output
FM-8800D	Waiting	0.5 A
	Receive	1.6 A at 4 W audio output
	Transmit	2 A at 1 W output, 6 A at 25 W output
	DUP Transmit	3.6 A at 1 W output, 7.6 A at 25 W output

7. DIGITAL INTERFACE

IEC 61162-1 (NMEA0183 Ver.3)

Input sentence & priority

DATE (for RTC): ZDA>RMC

TIME (for RTC): ZDA>GGA>RMC>GNS>GLL

Position & UTC (for DSC): GGA>RMC>GNS>GLL

Output sentence: TLL

Talker: GP>LC>DE>II>IN>EC

8. AMBIENT CONDITIONS

- (1) Temperature -15°C to 55°C (IEC60945)
- (2) Relative Humidity 93% (at 40°C)
- (3) Waterproofing (IEC 60529)
 - Transceiver Unit Chassis: IPX0, Panel: IPX4
 - Handset/Hanger HS-2003: IPX4
 - Remote Station/Handset RB-8800: IPX0
 - HS-8800: IPX2
 - RB-8810: IPX0
 - RB-8810-W: IP56
 - HS-8800-W: IP56
 - Junction Box IF-8810: IPX0
 - DMC Interface IF-8820: IPX0

9. COATING COLOR

- (1) Transceiver Unit Chassis: Munsell 2.5GY5/1.5, Panel: Munsell N3.0
- (2) VHF console 7.5BG7/2, 2.5G7/2 or user specified

INDEX

A

- Able acknowledge call 3-5
- ACK BQ 3-7
- Alarm setup 4-1
- All ships call 3-16
- Audio alarms 1-7
- Auto ACK setup 4-3
- Automatic acknowledge 1-13, 3-6

C

- Call key 1-12
- Cancel key 1-2, 1-7
- CH16 key 1-10
- Channel modes 1-8
- Coast call 3-2
- Contrast 1-14
- Controls 1-2

D

- Daily Test 6-2
- Dimmer 1-8
- DIST ACK signal 2-10
- Distress Alert 2-1
- Distress communication 2-1
- Distress key 2-1
- Distress relay 2-12
- Distress relay area call 2-19
- DSC operational 1-12
- Dual watch 1-10

E

- Earpiece volume 4-13
- Erasing logs 4-5
- Error message 6-6

F

- Front panel 1-1

G

- Group call 3-10
- Group ID list 5-1

I

- Intercom volume 4-14

K

- Key click 4-13

L

- LCD 1-5
- Log file 3-28
- Loudspeaker 1-8

M

- Maintenance 6-1
- Manually acknowledging 3-8
- Medical transport call 3-26
- Memory channel setup 4-6
- Message file entry 4-7

N

- Naming intercom 5-2
- Nature of distress 2-4
- Neutral craft call 3-24

O

- Off-hook loudspeaker 4-14
- Old position alarm 4-1
- Output power 1-9

P

- Polling call 3-22
- Position call 3-19
- Position setup 4-11
- Print out setup 4-12
- Priority 1-13
- Program version 5-3
- PSTN call 3-13

R

- Remote station 1-1

S

- Scanning 1-10
- Self ID 5-1
- Shift key 1-8
- Ship call 3-2
- Speaker domain 4-14
- Squelch 1-9
- Standby display 1-12

INDEX

T

Transceiver unit 1-1
Transmitting 1-9
Troubleshooting 6-1

U

Unable acknowledge call 3-5

V

Volume 1-8
Volume setup 4-13

