

FURUNO

OPERATOR'S MANUAL

DOPPLER SPEED LOG

Model **DS-80**

ECF

(Elemental Chlorine Free)

The paper used in this manual
is elemental chlorine free.

FURUNO ELECTRIC CO., LTD.

9-52 Ashihara-cho,
Nishinomiya, 662-8580, JAPAN

• FURUNO Authorized Distributor/Dealer

All rights reserved. Printed in Japan

Pub. No. OME-72470-R

(AKMU) DS-80

A : FEB. 2000

R : OCT. 01, 2020



0 0 0 8 0 8 8 9 6 1 5

IMPORTANT NOTICES

General

- This manual has been authored with simplified grammar, to meet the needs of international users.
- The operator of this equipment must read and follow the instructions in this manual. Wrong operation or maintenance can void the warranty or cause injury.
- Do not copy any part of this manual without written permission from FURUNO.
- If this manual is lost or worn, contact your dealer about replacement.
- The contents of this manual and the equipment specifications can change without notice.
- The example screens (or illustrations) shown in this manual can be different from the screens you see on your display. The screens you see depend on your system configuration and equipment settings.
- Save this manual for future reference.
- Any modification of the equipment (including software) by persons not authorized by FURUNO will void the warranty.
- The following concern acts as our importer in Europe, as defined in DECISION No 768/2008/EC.
 - Name: FURUNO EUROPE B.V.
 - Address: Ridderhaven 19B, 2984 BT Ridderkerk, The Netherlands
- All brand, product names, trademarks, registered trademarks, and service marks belong to their respective holders..

How to discard this product

Discard this product according to local regulations for the disposal of industrial waste. For disposal in the USA, see the homepage of the Electronics Industries Alliance (<http://www.eiae.org/>) for the correct method of disposal.

How to discard a used battery

Some FURUNO products have a battery(ies). To see if your product has a battery, see the chapter on Maintenance. Follow the instructions below if a battery is used. Tape the + and - terminals of battery before disposal to prevent fire, heat generation caused by short circuit.

In the European Union

The crossed-out trash can symbol indicates that all types of batteries must not be discarded in standard trash, or at a trash site. Take the used batteries to a battery collection site according to your national legislation and the Batteries Directive 2006/66/EU.

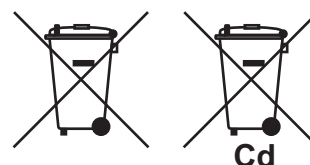

In the USA

The Mobius loop symbol (three chasing arrows) indicates that Ni-Cd and lead-acid rechargeable batteries must be recycled. Take the used batteries to a battery collection site according to local laws.

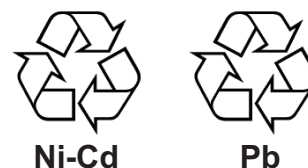

In the other countries

There are no international standards for the battery recycle symbol. The number of symbols can increase when the other countries make their own recycling symbols in the future.



SAFETY INSTRUCTIONS



WARNING



ELECTRICAL SHOCK HAZARD
Do not open the equipment.

Only qualified personnel should work inside the equipment.

Immediately turn off the power at the switchboard if water leaks into the equipment or an object is dropped into the equipment.

Continued use of the equipment can cause fire or electrical shock. Contact a FURUNO agent for service.

Do not place liquid-filled containers on the top of the equipment.

Fire or electrical shock can result if the liquid spills into the equipment.

Do not disassemble or modify the equipment.

Fire, electrical shock or serious injury can result.

Keep the equipment away from rain and water splash.

Fire or electrical shock can result if the rain or water gets into the equipment.

Do not operate the equipment with wet hands.

Electrical shock can result.

Keep heater away from equipment.

A heater can melt the equipment's power cord, which can cause fire or electrical shock.

Use the proper fuse.

Fuse rating is shown on the equipment. Use of a wrong fuse can result in damage to the equipment.



CAUTION

Do not use the equipment for other than its intended purpose.

Improper use of the equipment can result in personal injury or equipment damage.

Turn off the equipment immediately if you feel it is abnormal.

Turn off the power from the switchboard if the equipment is emitting strange noises or becomes excessively hot. Contact your dealer for advice.

The useable ambient temperature range is 15°C to 55°C.

Do not use the equipment out of the above temperature range.

Do not place objects around the equipment.

Overheating may result.

Do not power the equipment when the transducer is in air.

The transducer may become damaged.

Handle all units carefully.

Damage can lead to corrosion.

Do not use chemical cleaners such as alcohol, acetone and benzine to clean the equipment.

Chemical cleaners can remove paint and markings. Use only a soft, dry cloth. For stubborn dirt, use a soft cloth moistened with water-diluted mild detergent.

When dry docked remove marine life from the transducer.

Remove marine life to maintain good sensitivity.

Do not paint the transducer face. Further, handle the transducer with care.

Paint will affect equipment performance.

WARNING LABEL

A warning label is attached to the Distributor, Transceiver and Terminal Box. Do not remove the labels. If a label is missing or is illegible, contact a FURUNO dealer or agent about replacement.

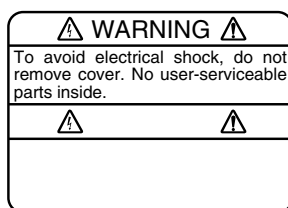

Name: Warning Label (1)
Type: 86-003-1011-0
Code No.: 100-236-230

RECORD OF REVISION IN THIS OPERATOR'S MANUAL

Date of Revision	Software (Prog. No.)	Outline of Revision
Apr/2000	03I-02J-02K (DS-800, DS-801, DS-810)	Publicized for submission to type test BSH
June/2000	DS-800: 6550100003I DS-801: 6550110003J DS-810: 6550120003K	Publicized for submission to type test BSH
Apr/2002	DS-800: 6550101003 DS-801: 6550110003 DS-810: 6550120003	Modified to conform to IEC 61162-1 Edition 2
Mar/2010	DS-800: 6550101004	Modified to conform to IEC62288 Modified abbreviations kn, NM, SIM
June/2012	DS-800: 6550101005 DS-810: 6550120006	Modified to conform to IEC 61162-1 Edition 4
Apr/2017	DS-800: 6550101006	Modified to conform to IEC 62288 Edition 2

TABLE OF CONTENTS

FOREWORD	1	2 OPERATION OF OPTIONAL	
SYSTEM CONFIGURATION.....	2	EQUIPMENT	12
PRINCIPLE OF OPERATION	3	2.1 Digital Indicator DS-830, Distance	
REMARKS ON USAGE	4	Indicator DS-840.....	12
1 OPERATION OF DISPLAY UNIT .	5	3 MAINTENANCE,	
1.1 Controls	5	TROUBLESHOOTING	15
1.2 Turning the Power On/Off.....	5	3.1 Maintenance	15
1.3 Adjusting Contrast, Panel Dimmer....	6	3.2 Troubleshooting	16
1.4 Selecting a Display	6	3.3 Diagnostics, Checking	
1.5 Main Menu Operation	7	Program Number	17
1.6 Distance Run Operation	7	4 DIGITAL INTERFACE	
1.7 System Setting.....	9	(IEC 61162-1 Edition 4)	18
1.8 Simulation Mode	11	4.1 I/O Sentences	18
		4.2 Sentence Description.....	21
		5 PARTS LOCATION AND	
		PARTS LIST	24
		Parts Location	24
		Parts List	26
		CALIBRATION SHEET	30
		MENU OVERVIEW	31
		LIST OF ABBREVIATIONS.....	32
		SPECIFICATIONS.....	SP-1
		INDEX.....	Index-1

FOREWORD

Foreword

Thank you for purchasing the FURUNO DS-80 Doppler Speed Log. We are confident you will discover why FURUNO has become synonymous with quality and reliability.

Since 1948, FURUNO Electric Company has enjoyed an enviable reputation for innovative and dependable marine electronics equipment. This dedication to excellence is furthered by our extensive global network of agents and dealers.

Please carefully read and follow the safety information and operating and maintenance instructions set forth in this manual before attempting to operate the equipment and conduct any maintenance. Your Doppler speed log will perform to the utmost of its ability only if it is operated and maintained in accordance with the correct procedures.

This equipment is designed, produced and documented by FURUNO Electric Co., Ltd., complying with ISO 9001 standards as certified by the Lloyd's Register of Quality Assurance System.

Features

The FURUNO DS-80 displays ship's speed relative to water, using the Doppler principle; ship's speed is measured by detecting the Doppler shift frequency from the signal returned from the watermass.

The output is interfaced with ARPA, AIS, and other shipborne equipment in IEC 61162-1 format.

The main features of the DS-80 are

- Simple operation. In most cases all that is required to display ship's speed is to turn on the equipment.
- Pair-beam system effectively reduces error caused by pitching. The transducer assembly symmetrically emits two sonic beams, one fore and the other aft. By averaging the Doppler shift in both directions accurate speed data is available under rough sea conditions.
- Speed and distance information on the adjustable-contrast LCD display.
- Analog display, digital Indicator and digital distance indicator display optionally available.
- Conforms to the following standards: IMO A.824(19), as amended by MSC.97(72), IMO A.694(17), IEC 61023, IEC 60945 (3rd edition), IEC 61162-1 (4th edition).

CE declaration

With regards to CE declarations, please refer to our website (www.furuno.com), for further information about RoHS conformity declarations.

SYSTEM CONFIGURATION

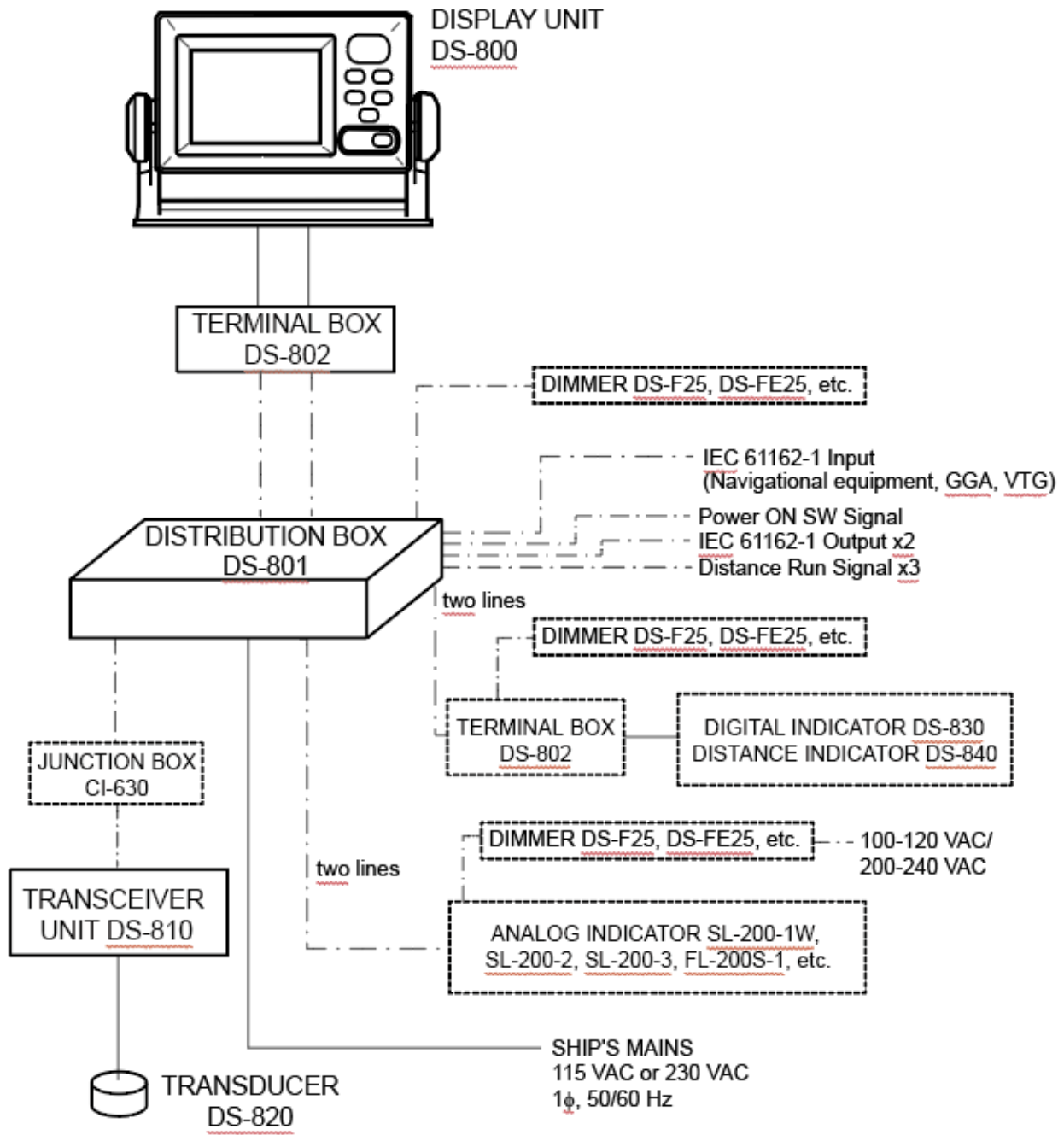

PRINCIPLE OF OPERATION

The Doppler speed log measures ship's speed by using the Doppler Effect, which is observed as a frequency shift resulting from relative motion between a transmitter and receiver or reflector of acoustic or electro-magnetic energy. A common example of the Doppler Effect is a train. When a train is approaching, the whistle has a higher pitch than normal. You can hear the change in pitch as the train passes.

The DS-80 has a pair-beam, one directed in the fore direction and the other in the aft direction, which emits ultrasonic waves at an angle of θ to the waterline towards ship's fore and aft directions. The frequency of the received signal is then compared with that of the transmitted frequency to measure doppler shift to calculate ship's speed.

The relative motion causes the Doppler shift and the ultrasonic waves reflected at the watermass (plankton or any underwater objects) are received at the frequency of $f_r = f_o + f_d$ where f_d is the number of frequency shifts counted at the receiver circuit. To calculate ship's speed, the following formula is used.

$$V = f_d / f_o \cdot c / 2 \sin \theta$$

c : Underwater velocity

Note that the sound velocity in water changes with water temperature and water pressure but the DS-80 readout is automatically compensated for change by using a temperature sensor.

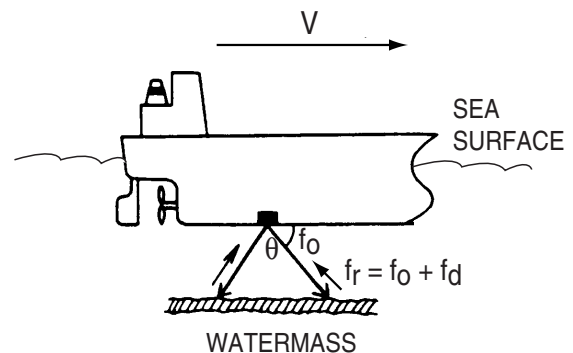

REMARKS ON USAGE

Remarks on Usage

The DS-80 measures ship's speed by detecting the Doppler shift frequency of the echo reflected by a watermass (water layer containing plankton and other micro-organisms) located within the measuring area, which is usually about 2 m. In some instances, however, no signal is returned because of too few plankton in the sensing depths. This phenomenon can occur in particular areas in particular seasons. The probable cause is the plankton are lying in deep water because an ice-melted cold water mass covers the sea surface. Similar cases may also occur in a freshwater lake. Under these circumstances the DS-80 will not show the correct ship's speed.

Conditions Affecting the Accuracy

(with ref to IMO A.824/3.3)

The Doppler speed log DS-80 is designed for reliable and accurate performance through FURUNO's long experience and advanced technology. It operates on the best choice of system frequency and power output. As far as the sonic energy is used, the performance (accuracy) may be reduced or even lost under:

- rough weather (may be sea state 6 or severer)
- improper location of sensor, e.g., too close to the propeller, thrusters, drain tubes, echo sounder transducer
- depth under the keel if less than 3 m

The accuracy will not be affected by:

- - water temperature (sound velocity)
- salinity
- pitch/roll $\pm 10^\circ$

Beware of Transducer Location

The transducer may be damaged if it hits the dry dock blocks. Take the following measures to prevent damage to the transducer.

1. Before delivering the ship, draw up a suitable docking plan taking into account the dimensions and location of the transducer. Store the plans onboard the ship.
2. Place the dry dock blocks according to the plan.
3. Have a diver check the position between the transducer and the blocks before removing the water. Confirm that the transducer will not touch the blocks.

1 OPERATION OF DISPLAY UNIT

1.1 Controls

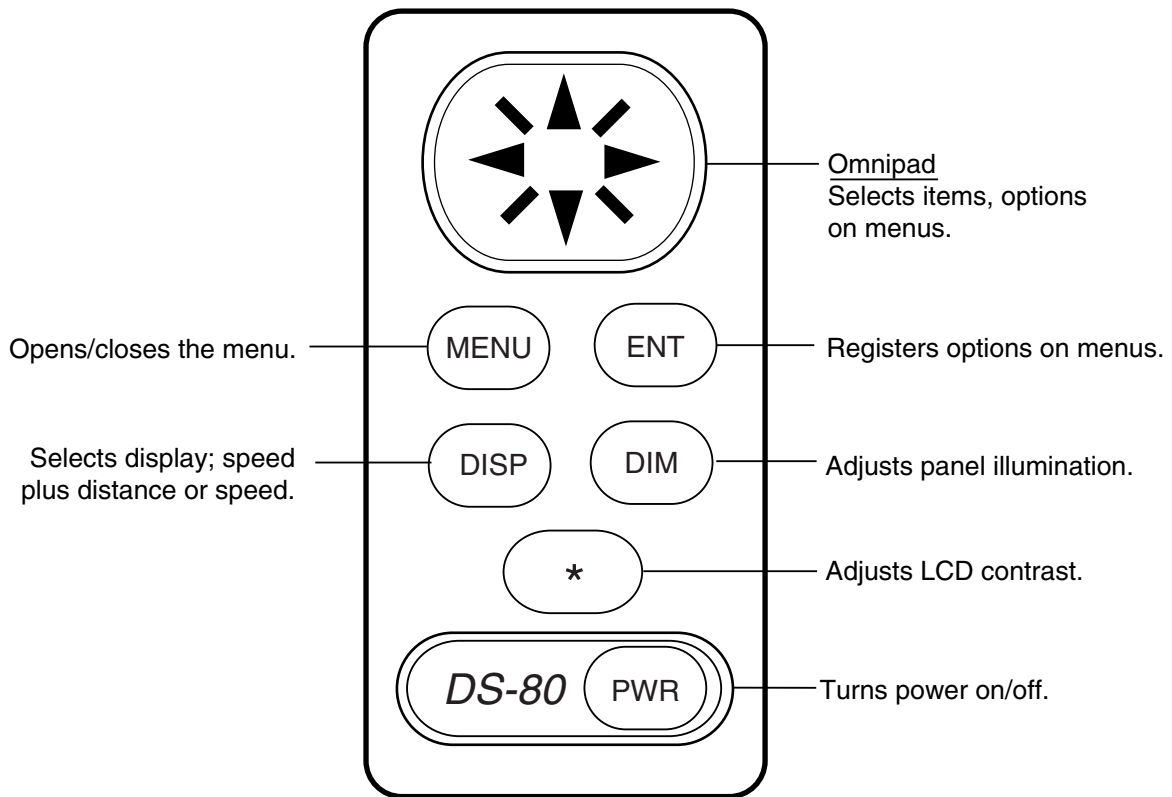

1.2 Turning the Power On/Off

1.2.1 Power on

Press the [POWER] switch to turn on the equipment. The last-used display appears. The example below shows the speed and distance run.

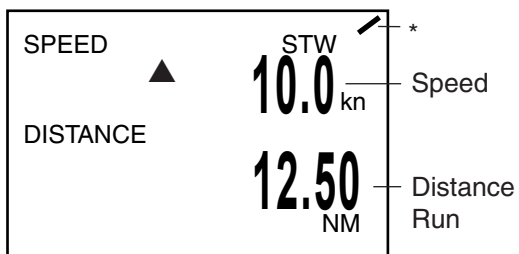

*: Bar mark rotates at normal condition. If the equipment freezes, it stops.

Note: STW means Speed Through Water. This indication flashes when transducer temperature, which can be monitored on the TEST display (see page 17), is abnormal. This means speed accuracy is less than stated in the specifications.

1.2.2 Power off

Press the [POWER] switch to turn the power off.

Note: Keep the DS-80 energized continuously unless it fails. Turning off the DS-80 may cause an inconvenience in associated equipment, such as a radar.

1.3 Adjusting Contrast, Panel Dimmer

1.3.1 Contrast

1. Press the [*] key to open the contrast adjustment dialog box.

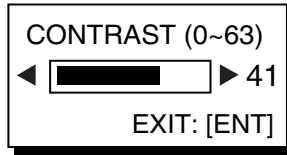

2. Press the Omnipad at ◀ or ▶ to adjust the contrast. The setting range is 0 to 63 and the default setting is 48.
3. Press the [ENT] key.

Note: The contrast is automatically set to default (48) when the power is turned on.

1.3.2 Panel dimmer

1. Press the [DIM] key to show the dimmer adjustment dialog box.

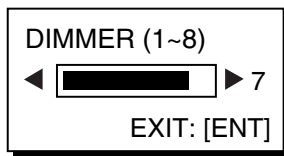

2. Press the Omnipad at ◀ or ▶ to adjust the dimmer. The setting range is 1 to 8 and the default setting is 4.
3. Press the [ENT] key to conclude.

Note: The [DIM] key is inoperative when dimmer is controlled externally.

1.4 Selecting a Display

Press the [DISP] key to select display desired. Each time the key is pressed the display shows speed and distance run or speed alone as below.

Note: The [DISP] key is inoperative when the menu is shown.

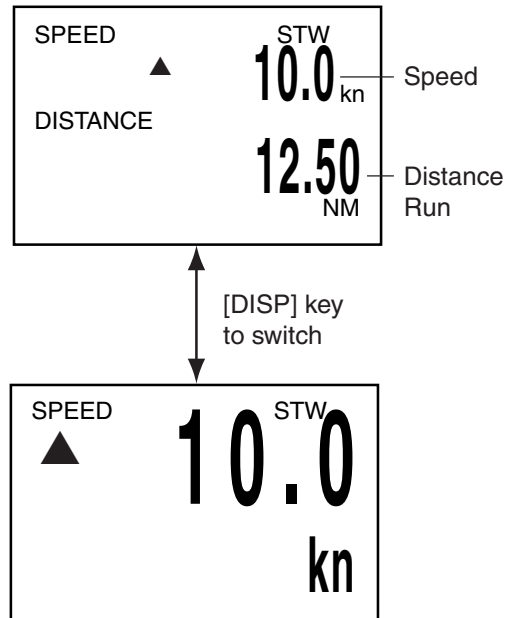

Speed: The speed through water of the vessel is shown. Arrow indicates direction: ▲ indicates fore; ▼, aft.

Note: Speed error may occur in rough seas because of air bubbles, etc.

When speed error occurs, the speed indication freezes, and “kn” is highlighted and blinks. If speed error continues more than 30 seconds, the speed indication changes to **.*

Distance Run: The distance run is calculated by only forward speed through water. The distance run is backed up when the power is turned off.

Note: If the setting for SPD DATA SELECT is changed to either [GPS] or [AUTO], the [DISTANCE] indication on the dual data screen automatically changes to COG. The [DISP] key becomes inactive and distance cannot be displayed. To return the setting to [DOPPLER], see section 1.7.6.

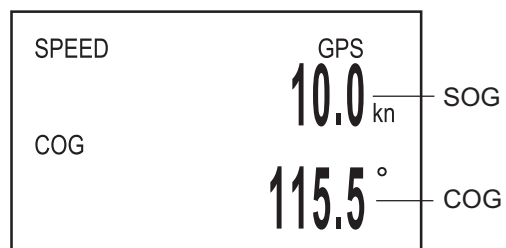

1.5 Main Menu Operation

Functions of the DS-80 are selected through the menu.

1. Press the [MENU] key to open the menu.

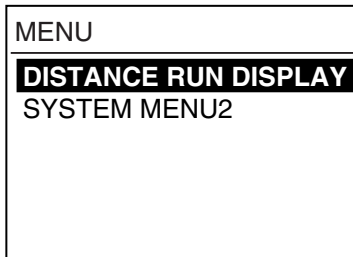

2. Press the Omnipad at ▲ or ▼ to select a menu item (current selection is highlighted) and press the [ENT] key. For example, when DISTANCE RUN DISPLAY is selected the following display appears. Distance run is a form of contact closure, 200 pulses/NM. To select IEC 61162 sentence, see paragraph 1.6.1.

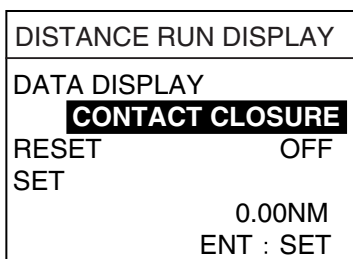

3. Press the Omnipad at ▲ or ▼ to select the menu item desired and press the [ENT] key. For example select RESET.

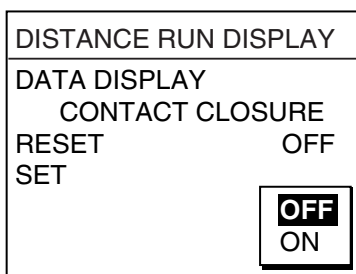

4. Press the Omnipad at ▲ or ▼ to select the menu option desired and press the [ENT] key.

5. Press the [MENU] key twice to close the menu. (Some menus require only a single pressing of the [MENU] key.)

To enter numerical data

Some menus require input of numeric data. This is done with the Omnipad.

1. Select the digit or sign (+ or -) to change with ◀ or ▶ on the Omnipad. (The cursor shows the digit or sign selected.)
2. Enter a figure at each digit by hitting the Omnipad at ▲ or ▼. The example below shows the DISTANCE RUN DISPLAY menu, where you may adjust the distance run indication for SET.

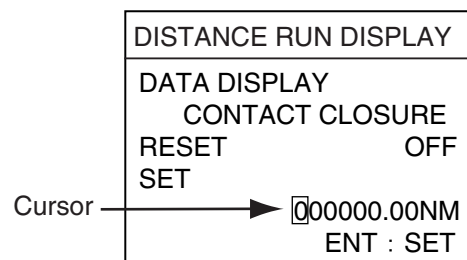

3. Press the [ENT] key to conclude.

1.6 Distance Run Operation

The operator may adjust and reset the distance run indication and select display method.

1.6.1 Selecting display method

The default setting provides for independent display and adjustment of the distance run indication on all displays (display unit, Digital Indicator, distance indicator).

To show the same distance run indication on all displays do the following:

1. Press the [MENU] key to open the menu.

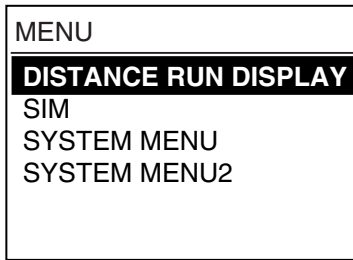

2. Press the Omnipad at ▲ to select DISTANCE RUN DISPLAY and press the [ENT] key.

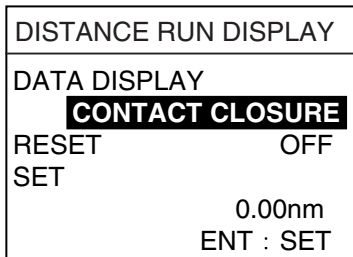

3. Select DATA DISPLAY and press the [ENT] key.

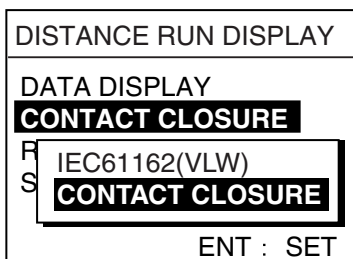

4. Press ▲ to select IEC 61162(VLW) and press the [ENT] key.
5. Press the [MENU] key twice to close the menu.

1.6.2 Adjusting distance run

Distance run can be changed when the menu item DATA DISPLAY is selected to CONTACT CLOSURE. It may also be changed only at the display unit when IEC 61162(VLW) is selected. .

1. Press the [MENU] key to open the menu.
2. Use ▲ to select DISTANCE RUN DISPLAY and press the [ENT] key.
3. Select SET and press the [ENT] key.

The cursor circumscribes the leftmost digit of the distance run figure.

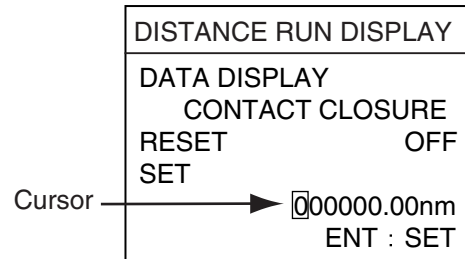

4. Press the Omnipad at ◀ or ▶ to select the digit to change.
5. Press the Omnipad at ▲ or ▼ to change value. The setting range is 0.00 NM to 999999.99 NM.
6. Press the [ENT] key followed by pressing the [MENU] key twice to conclude your selection and close the menu.

1.6.3 Resetting distance run to zero

Distance run can be reset to zero when the menu item DATA DISPLAY is selected to CONTACT CLOSURE. It may also be reset to zero only at the display unit when IEC 61162(VLW) is selected.

1. Press the [MENU] key to open the menu.
2. Press the Omnipad at ▼ to select DISTANCE RUN DISPLAY and press the [ENT] key.
3. Select RESET and press the [ENT] key.

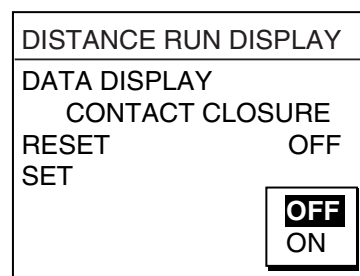

4. Press the Omnipad at ▼ to select ON.

5. Press the [ENT] key to finish and press the [MENU] key twice to close the menu.

The distance run indication reads 0.00.

1.7 System Setting

The system setting provides the fundamental parameters for intended performance of the DS-80.

1.7.1 Displaying the system menu

1. Press the [MENU] key to open the menu.
2. Select SYSTEM MENU and press the [ENT] key.

SYSTEM MENU	
SHIP SPEED AVG	15 SEC
SPEED OFFSET	+0.0%
TRACK DEPTH	2.0 m
XDR OFFSET	+00°
SPD DATA SELECT	
	DOPPLER
	ENT: SET

1.7.2 Ship speed average

Wind and currents affect ship's speed, and speed data is averaged over the time period set on this menu. Increase the speed averaging period if the speed reading is unstable.

1. Open the SYSTEM MENU.
2. Select SHIP SPEED AVG and press the [ENT] key.

15 SEC
30 SEC
45 SEC
60 SEC

3. Select averaging time period desired among 15, 30, 45 and 60 seconds.
4. Press the [ENT] key.
5. Press the [MENU] key twice to close the menu.

1.7.3 Speed offset (calibration)

Calibration of any speed log is necessary through the sea trials during the commissioning tests. Fill in the calibration sheet which is on page 30 of this manual. Use the resultant data to calculate speed offset and enter it as below. The setting range is -25.0% to +25.0%.

1. Open the SYSTEM MENU.
2. Select SPEED OFFSET and press the [ENT] key.

SYSTEM MENU	
SHIP SPEED AVG	30 SEC
SPEED OFFSET	±0.0%
TRACK DEPTH	2.0 m
XDR OFFSET	+00°
SPD DATA SELECT	
	DOPPLER
	ENT: SET

3. Select the digit to change with ◀ or ▶ and change the value with ▲ or ▼ on the Omnipad.
4. Press the [ENT] key.
5. Press the [MENU] key twice to close the menu.

1.7.4 Tracking depth

Doppler shift measuring depth in the DS-80 is 2 m at default. If the speed readout is unstable due to air bubbles near the ship's hull, increase or decrease the track depth to stabilize the readout. The setting range is 1.0 m to 9.9 m.

1. Open the SYSTEM MENU.

SYSTEM MENU	
SHIP SPEED AVG	30 SEC
SPEED OFFSET	+0.0%
TRACK DEPTH	2.0 m
XDR OFFSET	+00°
SPD DATA SELECT	
	DOPPLER
	ENT: SET

2. Select TRACK DEPTH and press the [ENT] key.

SYSTEM MENU	
SHIP SPEED AVG	30 SEC
SPEED OFFSET	+0.0%
TRACK DEPTH	2.0 m
XDR OFFSET	+00°
SPD DATA SELECT	
	DOPPLER
	ENT: SET

3. Select the digit to change ◀ or ▶ and change the value with ▲ or ▼ on the Omnipad.
4. Press the [ENT] key.
5. Press the [MENU] key twice to close the menu.

1.7.5 Transducer offset

Sets the deviation angle of the transducer's orientation with reference to the ship's longitudinal axis. This is done at installation; no user adjustment is necessary.

1.7.6 Speed data selection

The default setting for speed data selection is [DOPPLER]. You can change this setting to suit your needs. The options are:

DOPPLER: Use the DS-80 for speed data.

GPS: Use a connected GPS for speed data. (The [DISTANCE] indication is replaced with [COG]).

AUTO: Use the DS-80 for speed data, however, if the DS-80 fails, automatically switch to the connected GPS for speed data.

1. Open the SYSTEM MENU.
2. Select SPD DATA SELECT and press the [ENT] key.

GPS
DOPPLER
AUTO

3. Select the option GPS and press the [ENT] key.
4. Press the [MENU] key twice to close the menu.

See the illustration below for speed display information. If the speed displayed is unstable perform the check described in paragraph 3.2.

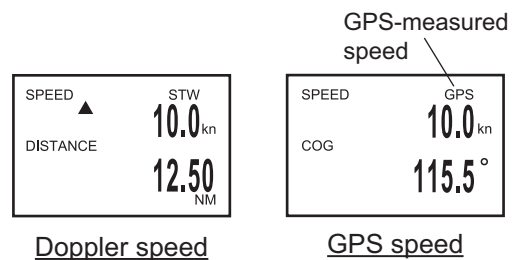

Note 1: If the log speed fails, the display unit reads a GPS speed, but speed data will not be output to other equipment.

Note 2: Doppler speed is used to calculate speed when both DOPPLER and GPS are abnormal in AUTO.

1.7.7 System menu 2

The System Menu 2 contains the diagnostic test and selection of dimmer control and display language.

1. Press the [MENU] key to open the menu.
2. Select SYSTEM MENU 2 and press the [ENT] key.

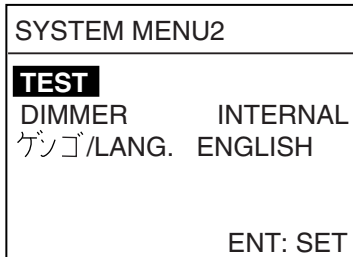

TEST: Checks the equipment for proper operation. For further details see Chapter 3.

DIMMER: See paragraph 1.3.2.

LANG.: Selects the language to use in menus, English or Japanese.

1.8 Simulation Mode

The simulation mode outputs the Doppler speed signal to external equipment. This checks if the signal is being correctly output.)

1. Press the [MENU] key to open the menu.
2. Select SIM and press the [ENT] key.

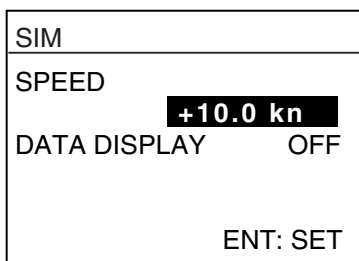

3. Select SPEED and press the [ENT] key.

4. Select the digit to change with ◀ or ▶.
5. Use ▲ or ▼ to set. (The setting range is -10.0 to +40.0 kn, and the default setting is +10.0 kn.)
6. Press the [ENT] key.
7. Press the [ENT] key to open the DATA DISPLAY menu.

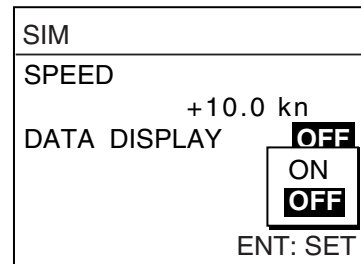

8. Press ▲ to select ON and press the [ENT] key.
9. Press the [MENU] key twice to close the menu.

The indication "SIM" appears at the top right-hand corner when the sim mode is on. To turn off the simulation display, show the SIM menu and set DATA DISPLAY to OFF.

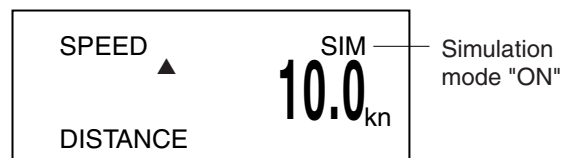

2 OPERATION OF OPTIONAL EQUIPMENT

The Digital Indicator DS-830 and Distance Indicator DS-840 have the same controls as the display unit. This chapter explains the features which are not shared with the display unit.

2.1 Digital Indicator DS-830, Distance Indicator DS-840

2.1.1 Selecting a display

Press the [DISP] key to select the display mode. Each time the key is pressed the display shows speed plus distance run or speed alone as below.

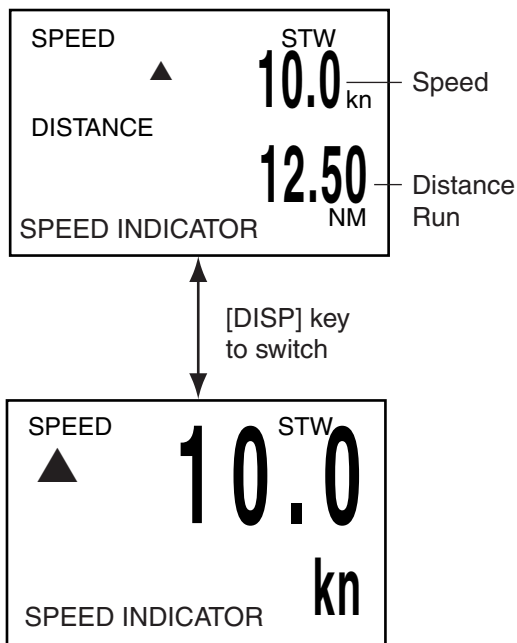

Digital Indicator DS-830

Note: If the setting for SPD DATA SELECT is changed to either [GPS] or [AUTO], the [DISTANCE] indication on the dual data screen automatically changes to COG. The [DISP] key becomes inactive and distance cannot be displayed.

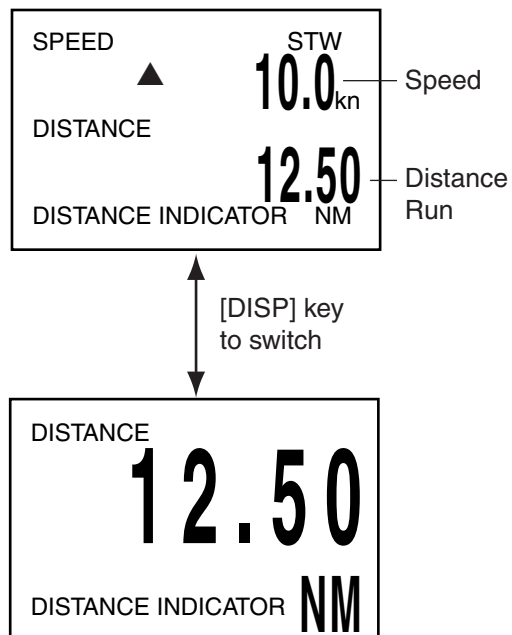

Distance Indicator DS-840

Note: If the setting for SPD DATA SELECT is changed to either [GPS] or [AUTO], the [DISTANCE] indication on the dual data screen automatically changes as shown below.

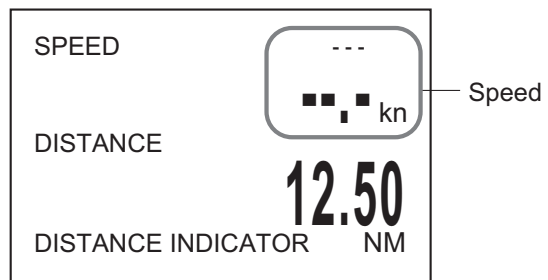

2.1.2 Menu operation

1. Press the [MENU] key to show the display below.

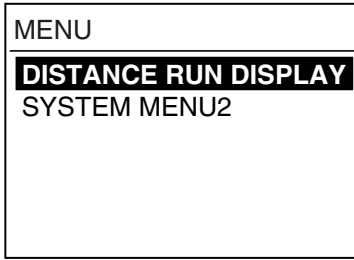

SYSTEM MENU 2: See 1.7.7 System Menu 2.

2.1.3 Adjusting dimmer and contrast

See paragraph 1.3.

2. For details refer to the following:

DISTANCE RUN DISPLAY: See paragraph 1.6.

ANALOG DISPLAY UNIT CORRECTION DIAGRAM AT EXTREME TEMPERATURES

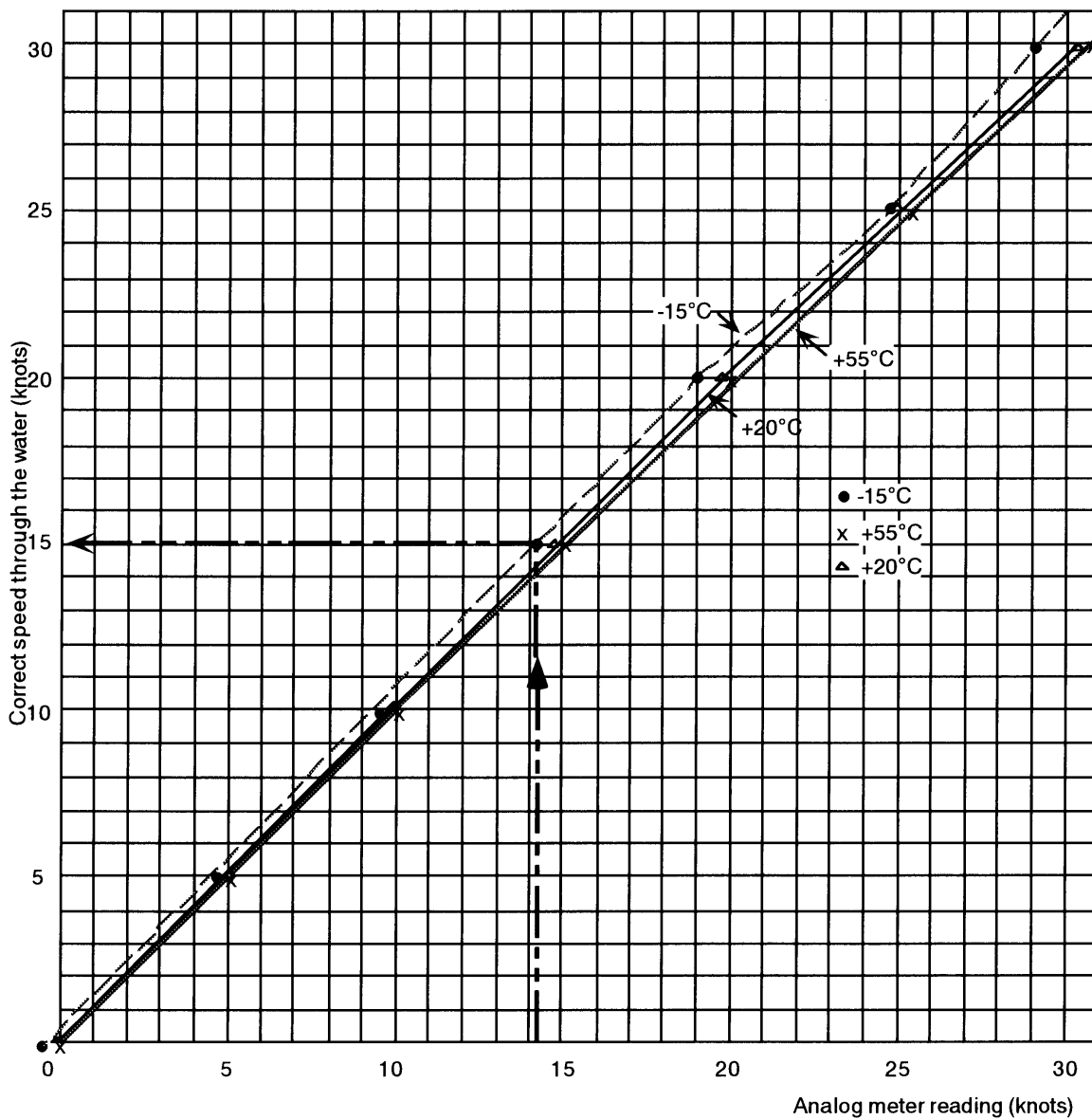

Doppler Speed Log DS-80
CORRECTION FACTOR FOR ANALOG DISPLAY MF-22A-1

Example:

If the analog speedometer reads 14.2 kn at a temperature of -15°C , the correct speed through the water is 15 kn. Failure of correction in low temperature can result in a maximum error of -0.8 kn or 5.3% for 14.2 kn readout. IMO limit of $\pm 2\%$ is exceeded over 10.0 – 30.0 kn reading but correction by this graph brings a correct measurement.

At $+55^{\circ}\text{C}$, an error of $+0.0$ kn ($+2.7\%$) occurs at a speed of 30 kn; no other point IMO limit of $\pm 2\%$ is exceeded.

When the digital display and analog display readouts are different, take precedence of the digital readout. At temperatures 0°C to 50°C , the speedometer never exceeds the IMO limits.

3 MAINTENANCE, TROUBLESHOOTING

WARNING

ELECTRICAL SHOCK HAZARD
Do not open the equipment.

Only qualified personnel should work inside the equipment.

CAUTION

Do not paint the transducer.

Painting will affect performance.

3.1 Maintenance

3.1.1 Preventive maintenance

Check the following points regularly to maintain performance.

- Check that the connectors on all units of the system are firmly fastened and free of rust. Clean if soiled or corroded.
- Check that all ground wires are tightly fastened.
- Dust and dirt on the display unit including the screen may be removed with a soft cloth. Do not use chemical cleaners to clean the display unit; they can remove paint and markings.

3.1.2 Transducer maintenance

Marine life (barnacles, etc.) adhering to the transducer face will reduce sensitivity. Periodically remove any marine life from the transducer face with fine sandpaper or a piece of wood.

3.1.3 Fuse replacement

Fuses in the units of the system protect the electrical circuitry from burning by overcurrent. If the equipment cannot be energized check the fuse in the power cable connected to the display unit. Locate the cause before replacing the fuse.

Unit	Rating, Qty	Type, Code No.	Location
Display Unit	1A, 2 pcs.	FGMB 1A 125 VAC, 000-114-805	Fuse holder in power cable
Distribution Box	3A, 2 pcs.	FGBO 3A 250 VAC 000-549-021	Inside unit
Transceiver Unit	1A, 2 pcs.	FGBO 1A 250 VAC, 000-549-019	



CAUTION

Use the proper fuse.

Use of a wrong fuse can cause fire or equipment damage and void the warranty.

3.2 Troubleshooting

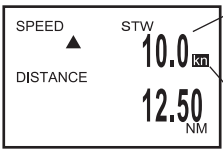
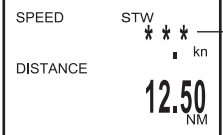
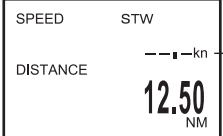
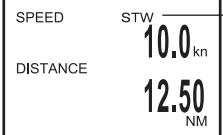
This section provides troubleshooting procedures. Advanced level troubleshooting should be done by referring to the Service Manual (optional supply).

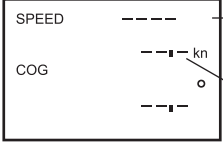
Problem	Probable cause	Remedy
General		
Cannot turn on the power.	Loosened power cable	Fasten the power cable.
	Blown fuse	Replace the fuse.
Power is on but nothing appears on the screen.	Contrast too low.	Press the [*] key several times.
Doppler speed indication		
 <p> SPEED ▲ STW 10.0 kn DISTANCE 12.50 NM </p> <p> Last correct speed is displayed (display freezes). Reverse video and blinking </p>		Ship's speed cannot be calculated because of air bubbles, etc. (Speed error : 30 seconds)
 <p> SPEED STW *** kn DISTANCE 12.50 NM </p> <p> Indication for [SPEED] appears as "***.*". </p>		<ul style="list-style-type: none"> • Problem with the transducer or air bubbles. • Speed error continues more than 30 seconds.
 <p> SPEED STW --- kn DISTANCE 12.50 NM </p> <p> Indication for [SPEED] appears as "--.*". </p>		<ul style="list-style-type: none"> • No speed data for 30 seconds.
 <p> SPEED STW 10.0 kn DISTANCE 12.50 NM </p> <p> STW flashing </p>		<ul style="list-style-type: none"> • Temperature sensor is abnormal.
GPS speed indication		
 <p> SPEED GPS *** kn COG ** * ° </p> <p> Indication for [SPEED] appears as "***.*". </p>		GPS data error.
 <p> SPEED ---- COG --- kn --- ° </p> <p> "GPS" is replaced with "----". Indication for [SPEED] appears as "--.*". </p>		<ul style="list-style-type: none"> • No GPS data for 30 seconds. • GPS receiver disconnected.

If any abnormal speed indication continues contact your dealer for advice.

3.3 Diagnostics, Checking Program Number

The diagnostic facility checks the ROM, RAM, SIO and displays program ID.

1. Press the [MENU] key to open the menu.
2. Select SYSTEM MENU2 and press the [ENT] key.

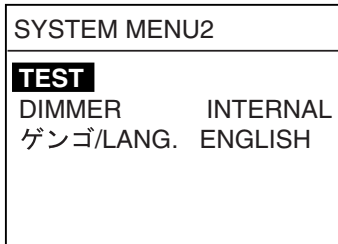

3. Press the [ENT] key. The following display appears.

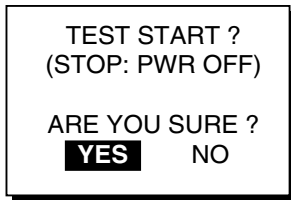

4. Press the [ENT] key to start the test. In a few moments the display should change as shown at the top of the adjacent column.

The ROM, RAM and SIO (if special connector is used) are checked for proper operation and the results shown as OK or NG (No Good). For NG, contact your dealer for advice.

The program number also appears here.

“PUSH KEY” is highlighted, prompting you to check the controls. Operate any control (except the [POWER] switch) within five seconds. The name of the activated control appears on screen if it is operating normally. Note that if no

control is operated within five seconds, the equipment automatically begins checking the LCD.

Transducer temperature

Name of control operated appears here.

TEST		
ROM	: OK	12.3CX
RAM	: OK	
SIO	: OK	
PUSH KEY		
(STOP: PWR OFF)		
	6550101005	
	6550110003	
CNT: 006	6550120006	

X appears when temperature sensor is abnormal

No. of times test consecutively executed.

6550101005 = Display Unit DS-800
 6550110003 = Distribution Box DS-801
 6550120006 = Transceiver Unit DS-810

Control operated and indication

Control	Indication
▲	UP
▼	DOWN
◀	LEFT
▶	RIGHT
MENU	MENU
ENT	ENT
DISP	DISP
DIM	DIM
*	*

5. The equipment automatically checks the LCD, displaying the following in order.

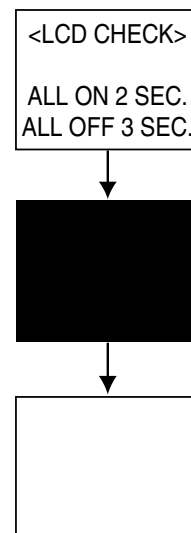

6. The test repeats itself. To stop the test, turn the power switch off and on again.

4 DIGITAL INTERFACE (IEC 61162-1 Edition 4)

4.1 I/O Sentences

Input sentences of IEC61162_RX port

GGA, VTG

Output sentences of IEC61162_TX1, IEC61162_TX2 ports

VBW, VLW (Talker: VD)

Transmission interval

3 s for VBW, VLW

Data transmission

Data is transmitted in serial asynchronous form in accordance with the standard referenced in 2.1 of IEC 61162-1. The first bit is a start bit and is followed by data bits, least-significant-bit as illustrated below.

The following parameters are used:

Baud rate: 4800

Data bits: 8 (D7 = 0), parity none

Stop bits: 1

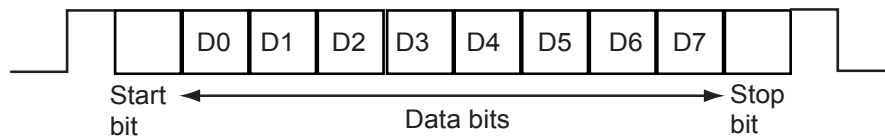

Schematic diagrams

IEC61162 RX port

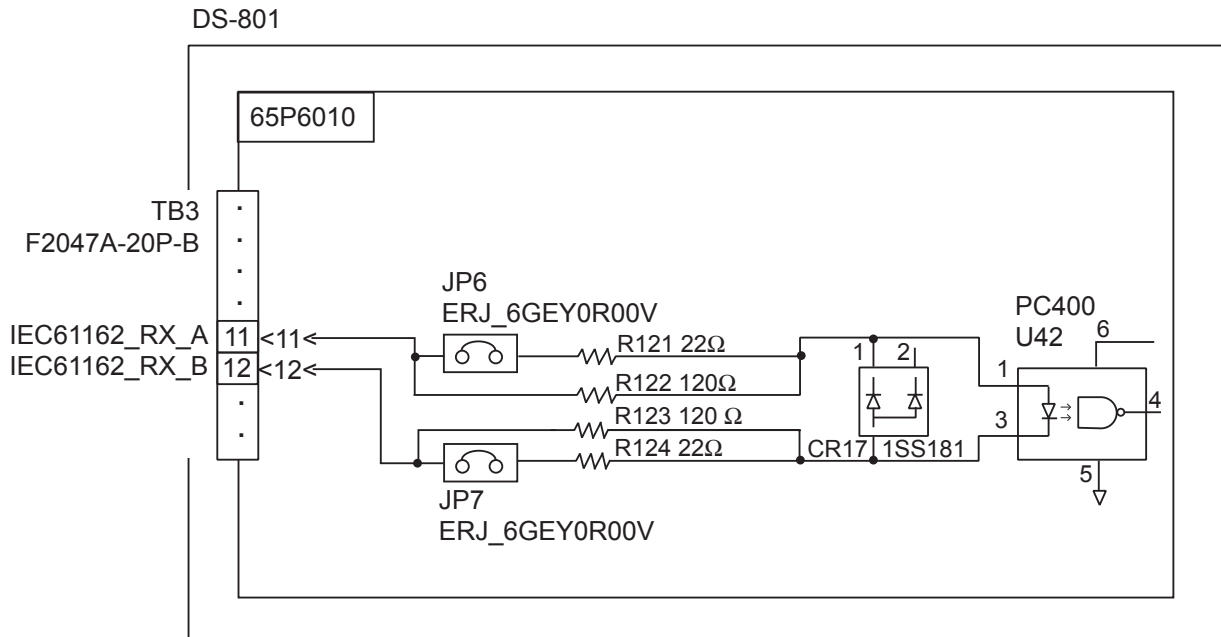

Load requirements as listener

Isolation: Optocoupler

Input Impedance: 44 ohms

Max. Voltage: $\pm 2.6V$

Threshold: 4 mA

IEC61162 TX1 port

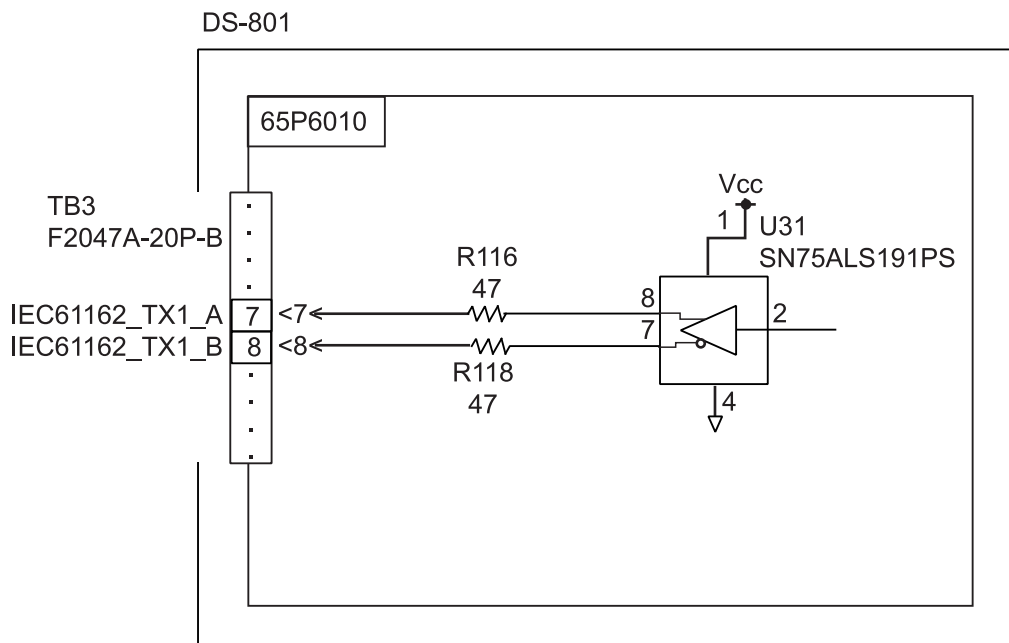

Output drive capability

Max. 20 mA

IEC61162 TX2 port

DS-801

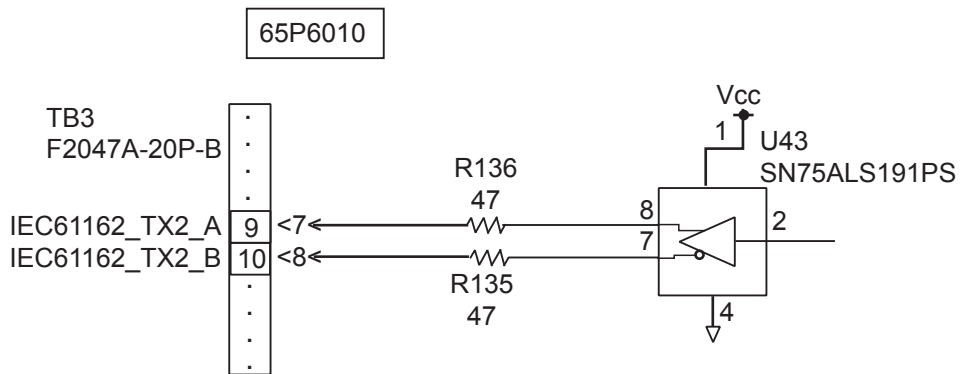

Output drive capability

Max. 20 mA

4.2 Sentence Description

GGA - Global positioning system (GPS) fix data

Time, position and fix related data for a GPS receiver.

\$--GGA,hhmmss.ss,lll.lll,a,yyyyy.yyy,a,x,xx,x.x,x.x,M,x.x,M,x.x,xxxx*hh<CR><LF>

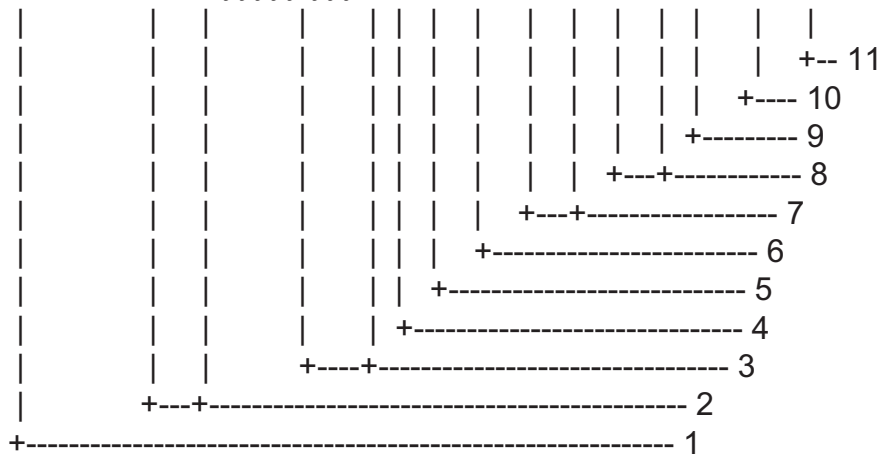

1. UTC of position
2. Latitude, N/S
3. Longitude, E/W
4. GPS quality indicator (see note)
5. Number of satellite in use,00-12, may be different from the number in view
6. Horizontal dilution of precision
7. Antenna altitude above/below mean sealevel, m
8. Geoidal separation, m
9. Age of differential GPS data
10. Differential reference station ID, 0000-1023
11. Checksum

NOTE

- 0 = fix not available or invalid
- 1 = GPS SPS mode, fix valid
- 2 = differential GPS, SPS mode, fix valid
- 3 = GPS PPS mode, fix valid
- 4 = Real Time Kinetic. Satellite system used in RTK mode with fixed integers
- 5 = Float RTK. Satellite system used in RTK mode with floating fingers
- 6 = Not used.
- 7 = Not used.
- 8 = Not used.

The GPS quality indicator shall not be a null field.

Note: Item Only GPS quality indicator are used.

VTG - Course over ground and ground speed

The actual course and speed relative to the ground.

\$--VTG,x.x,T,x.x,M,x.x,N,x.x,K,a*hh<CR><LF>

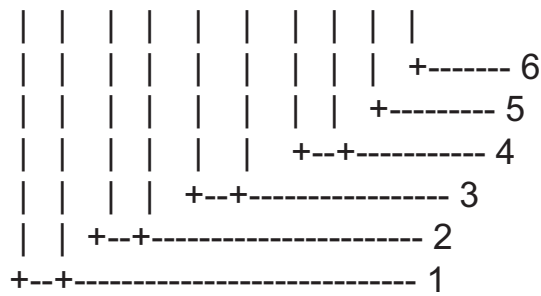

1. Course over ground, degrees true
2. Course over ground, degrees magnetic
3. Speed over ground, knots
4. Speed over ground, km/h
5. Mode indicator (see Note.)
6. Checksum

Note: Positioning system Mode indicator;

A = Autonomous mode;

D = Differential mode;

E = Not used.

M = Not used.

P = Precise. Satellite system used in precision mode. Precision mode is defined as: no deliberate degradation (such as selective availability) and higher resolution code (P-code) is used to compute position fix. P is also used for satellite system used in multi-frequency, SBAS or Precise Point Positioning (PPP) mode;

S = Not used.

N = Not used.

The mode indicator field should not be a null field.

Note: Course over ground, degrees magnetic is not used.

VBW - Dual ground/water speed

Water-referenced and ground-referenced speed data.

\$--VBW,x.x,x.x,A,x.x,x.x,A,x.x,A,x.x,A*hh<CR><LF>

```

| | | | | | | | | | |
| | | | | | | | | | +--- 11
| | | | | | | | | | +---- 10
| | | | | | | | | | +----- 9
| | | | | | | | | | +----- 8
| | | | | | | | | | +----- 7
| | | | | | | | | | +----- 6
| | | | | | | | | | +----- 5
| | | | | | | | | | +----- 4
| | | | | | | | | | +----- 3
| | | | | | | | | | +----- 2
+----- 1

```

1. Longitudinal water speed, knots
2. Transverse water speed, knots
3. Status: water speed, A=data valid V=data invalid
4. Longitudinal ground speed, knots
5. Transverse ground speed, knots
6. Status: ground speed, A=data valid V=data invalid
7. Stern transverse water speed, knots
8. Status: stern water speed, A=data valid V=data invalid
9. Stern transverse ground speed, knots
10. Status: stern ground speed, A=data valid V=data invalid
11. Checksum

Notes

1. Longitudinal speed: "-" astern.
- * Not used.

VLW - Distance travelled through the water

The distance travelled, relative to the water.

IEC61162-1 Ed.1/Ed.2

\$--VLW,x.x,N,x.x,N*hh<CR><LF>

```

| | | | |
| | | | | +----- 3
| | +----- 2
+----- 1

```

1. Total cumulative distance, nautical miles
2. Distance since reset, nautical miles
3. Checksum

IEC61162-1 Ed.3/Ed.4

\$--VLW,x.x,N,x.x,N,x.x,N,x.x,N*hh<CR><LF>

```

| | | | | | | | |
| | | | | | | | | +-----5
| | | | | | | | | +--+-----4
| | | | | | | | | +--+-----3
| | +--+-----2
+--+-----1

```

1. Total cumulative water distance, nautical miles
2. Water distance since reset, nautical miles
3. Total cumulative ground distance, nautical miles
4. Ground distance since reset, nautical miles
5. Checksum

5 PARTS LOCATION AND PARTS LIST

Parts Location

Display unit DS-800

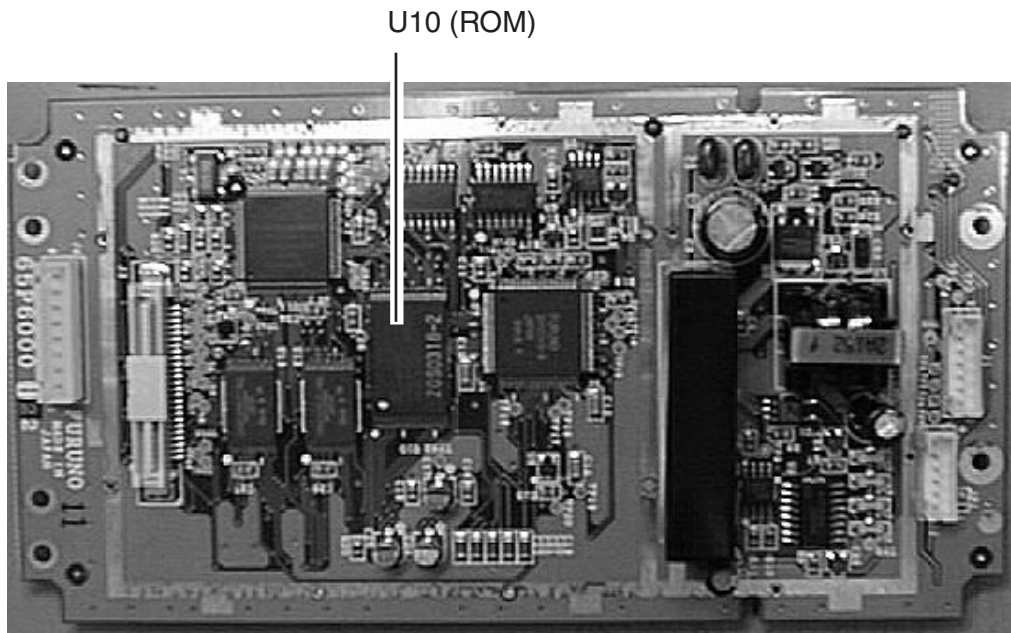

ICP Board 65P6000, parts side

Distribution box DS-801

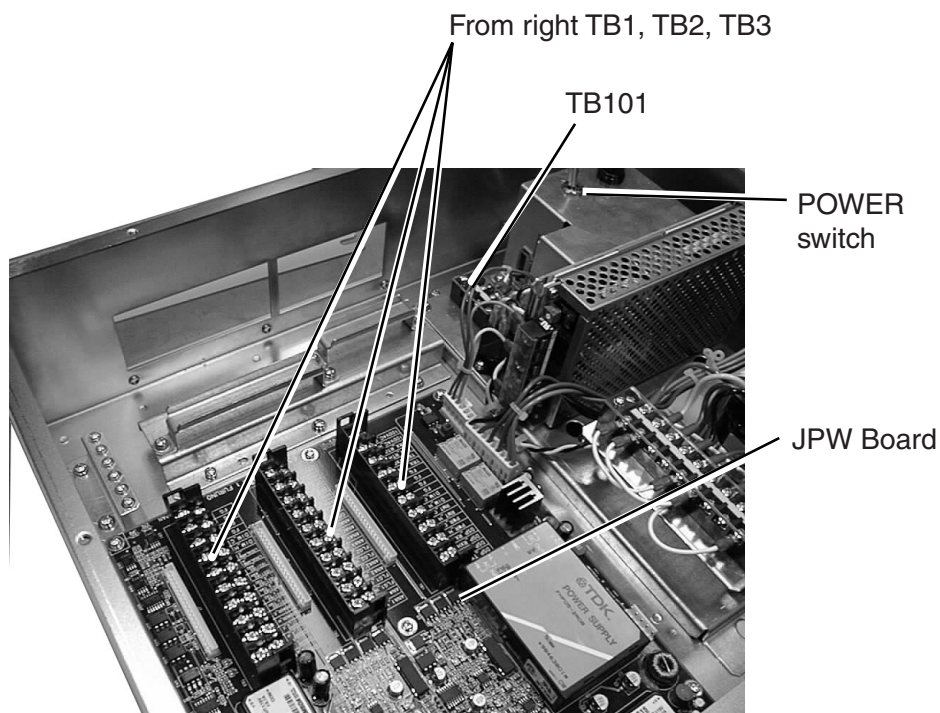

Distribution Box DS-801, inside view

Transceiver unit DS-810

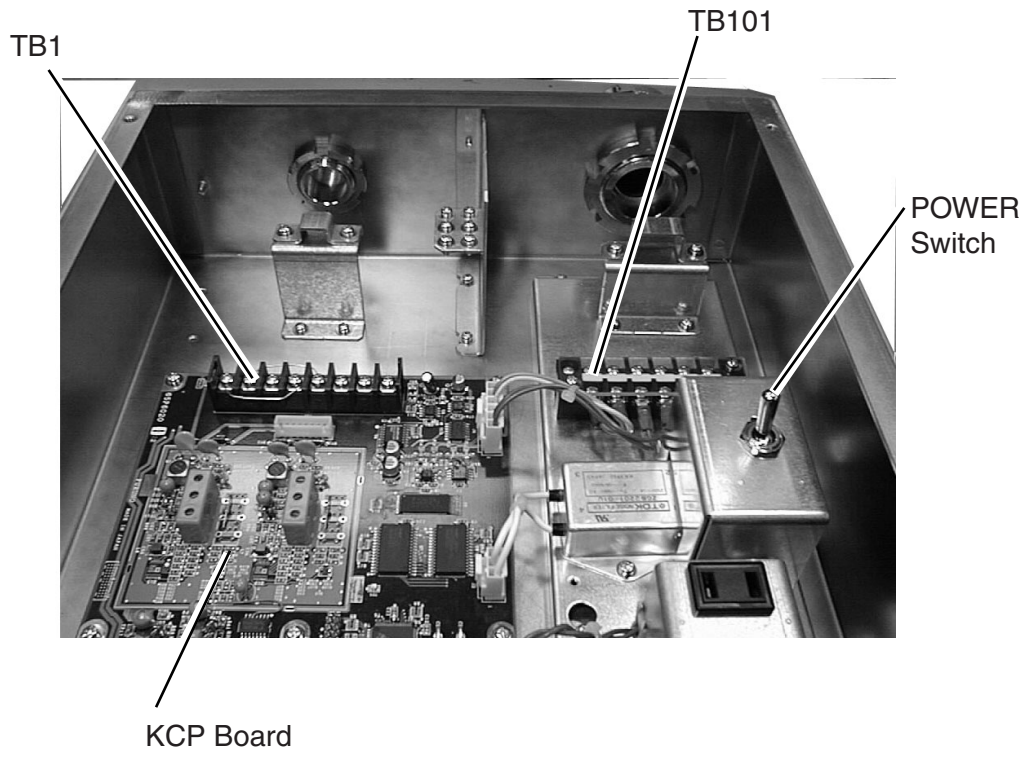

Transceiver Unit DS-810, inside view

Parts List

This equipment contains complex modules in which fault diagnosis and repair down to component level are not practicable (IMO A.694(17)/8.3.1). Only some discrete components are used. FURUNO ELECTRIC CO., LTD. believes identifying these components is of no use for shipborne maintenance; therefore, they are not listed in this manual. Major modules can be located on parts location photos on the preceding page.

ELECTRICAL PARTS LIST

2000-01

Model	DS-80	
Unit	DISPLAY UNIT DS-800	
Ref.Dwg.	C3441-K01-C	
Block.No.		

SYMBOL	TYPE	CODE No.	REMARKS	SHIPPABLE ASSEMBLY
PRINTED CIRCUIT BOARD				
	65P6000, ICP	000-142-649		X
CABLE w/CONNECTOR				
	MJ-A7SPF-005-020	000-139-384	20S0251	
	MJ-A6SPF-003-020	000-142-658	65S1231	
	MJ-PH 6P	000-142-659	65S1227	
	MJ-PH 7P	000-142-660	65S1228	

ELECTRICAL PARTS LIST

2000-01

Model	DS-80	
Unit	TRANSCEIVER DS-810	
Ref.Dwg.	C7247-K02-A	
Block.No.		

SYMBOL	TYPE	CODE No.	REMARKS	SHIPPABLE ASSEMBLY
PRINTED CIRCUIT BOARD				
	65P6020,KCP	002-889-570		X
POWER SUPPLY ASSEMBLY				
	DS-810	002-889-530		X
SWITCH				
S1	S-331	000-474-214		
VARISTOR				
CR1	ERZV-20D471	000-136-287		
TRANSFORMER				
T1	65S1218	000-142-647		
TERMINAL BOARD				
TB101	F1003-20A-5725-6P	000-137-321		
NOISE FILTER				
XF1	ZGB2202-01U	000-132-968		
CABLE w/CONNECTOR				
	66-045(2P)	002-889-550	VH CONNECTOR	
	65-046(6P)	002-889-560	VH CONNECTOR	

ELECTRICAL PARTS LIST

2000-01

Model	DS-80	
Unit	DISTRIBUTOR DS-801	
Ref.Dwg.	C7247-K03-A	
Block No.		

SYMBOL	TYPE	CODE No.	REMARKS	SHIPPABLE ASSEMBLY
PRINTED CIRCUIT BOARD				
	65P6010,JPW	002-889-490		X
ASSEMBLY				
	DS-801	002-889-470	POWER SUPPLY	X
POWER SUPPLY ASSEMBLY				
	DS-801-100	002-889-410		X
	DS-801-110	002-889-420		X
	DS-801-115	002-889-430		X
	DS-801-200	002-889-440		X
	DS-801-220	002-889-450		X
	DS-801-230	002-889-460		X
SWITCH				
S1	S-331	000-474-214		
VARISTOR				
CR1	ERZV-20D471	000-136-287		
TERMINAL BOARD				
TB101	F1003-20A-2P	000-142-631		
FUSE HOLDER				
F1	FH-001AF	000-138-909		
POWER SUPPLY				
PD1	FAW-24-2R1	000-142-633		
NOISE FILTER				
XF1	ZAC2210-11	000-120-155		

MENU OVERVIEW

Default settings in bold italic.

[MENU] key

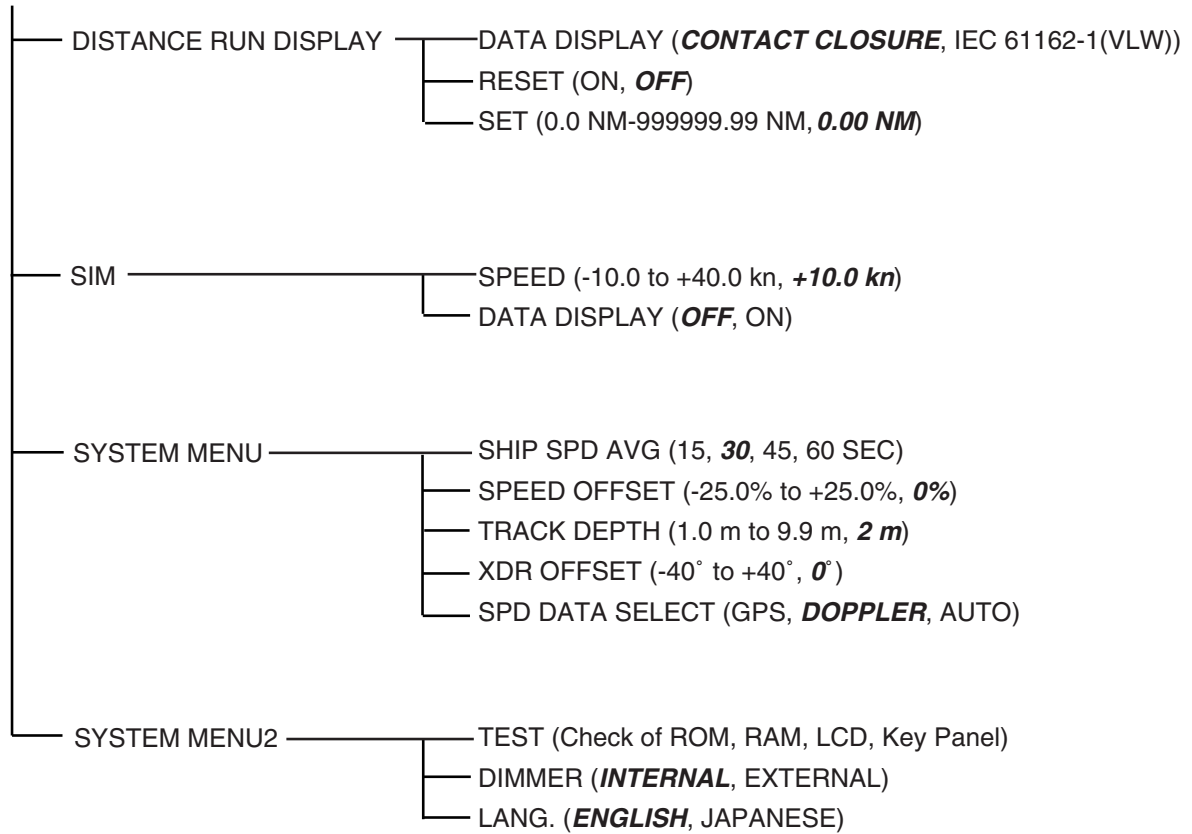

LIST OF ABBREVIATIONS

Abbreviation	Meaning
AVG	Average
COG	Course Over the Ground
DEP	Depth
DIM	Dimmer
DISP	Display
DIST	Distance
ENT	Enter
GPS	Global Positioning System
kn	Knot(s)
LANG	Language
MENU	Menu
NM	Nautical Mile(s)
OFF	Off
OFFSET	Offset
ON	On
PWR	Power
SEC,s	Second(s)
SEL	Select
SIM	Simulation
SOG	Speed Over the Ground
SPD	Speed
STW	Speed Through the Water
TRK	Track
XDR	Transducer

**SPECIFICATIONS OF THE DOPPLER SPEED LOG
DS-80**

1 GENERAL

- 1.1 Speed range Fore-Aft: -10.0 to +40.0 kn through-the-water
- 1.2 Distance run 0.00 to 999,999.99 NM through-the-water
- 1.3 Working depth Water depth greater than 3 m beneath the keel
- 1.4 Working frequency 1.0 MHz
- 1.5 Speed accuracy 1.0% or 0.1 kn whichever is the greater
- 1.6 Distance accuracy 1.0% or 0.1 NM whichever is the greater

Note: Accuracy is subject to shallow water effects, to the effect of wind, current and tide, and sensor location. Any ultrasonic equipment having the same frequency may interfere with speed measurement. The Doppler Log transducer should be installed apart from the transducers of such kind of equipment.

2 DISPLAY UNIT

- 2.1 Display 4.5-inch monochrome LCD, 120 x 64 dots
- 2.2 Visible distance 0.7 m nominal

3 INTERFACE

- 3.1 Serial signal
 - Output: 2 ports; VBW, VLW in IEC 61162-1
 - Input: 1 port; IEC 61162-1
- 3.2 Digital signal 2 ports; for sub display
- 3.3 Analog signal
 - Speed signal for Analog display: 2 port
 - 3.3 mA to 10 mA/ -10 kn to +30 kn
 - Analog current output: 1 port
 - 4 mA to 20 mA/ -10 kn to 30 kn
 - Analog voltage output: 1 port
 - 3.3 V to 10 V/ -10 kn to 30 kn
- 3.4 Distance run output 2 ports; Contact closure each 0.005 NM, 30 VDC: 0.2 A, forward speed, pulse length: 1.0ms
- 3.5 System check signal 1 port, 30 VDC: 0.2 A, default: closed

4 POWER SOURCE

100/110/115/200/220/230 VAC:1.5/0.7 A max, 1 phase, 50-60 Hz

5 ENVIRONMENTAL CONDITION

- 5.1 Ambient temperature -15°C to +55°C
- 5.2 Relative humidity 95% at 40°C
- 5.3 Vibration IEC 60945

5.4 Degree of protection

Display unit/ Transceiver unit

IPX2

Transducer IPX8, for submerged 600 kPa x 12 h

Distributor/ Terminal box IPX2

6 COATING COLOR

6.1 Display unit N2.5

6.2 Others 2.5GY5/1.5

7 COMPASS SAFE DISTANCE

7.1 Display unit Standard: 1.20 m, Steering: 0.80 m

7.2 Transceiver unit Standard: 2.05 m, Steering: 1.40 m

7.3 Distribution box Standard: 3.10 m, Steering: 2.10 m

7.4 Terminal box Standard: 0.65 m, Steering: 0.45 m

INDEX

C

Contrast.....	6
Controls	5

D

Diagnostics	17
Digital indicator.....	12
Digital interface.....	18
Digital display.....	13
DIM key.....	6
Dimmer.....	6
Distance run	
adjusting	8
resetting to zero.....	8

F

Fuse replacement.....	15
-----------------------	----

M

Maintenance.....	15
MENU key.....	7
Menu operation.....	7
Menu tree	31

P

Parts list.....	26
Parts location.....	24
POWER switch	5

S

Ship's speed	
averaging time.....	9
offset.....	9
source	10
Simulation mode.....	11
System configuration	2
System menu	9
System menu 2	11

T

Transducer	
maintenance	15
position offset.....	10

U

UNIT key	7
----------------	---

W

Water tracking depth	9
----------------------------	---

Declaration of Conformity



0560

We **FURUNO ELECTRIC CO., LTD.**

(Manufacturer)

9-52 Ashihara-Cho, Nishinomiya City, 662-8580, Hyogo, Japan

(Address)

declare under our sole responsibility that the product

DOPPLER SPEED LOG DS-80

(Serial No. 2210/2259/2263-xxxx)

(Model name, type number)

to which this declaration relates conforms to the following standard(s) or normative document(s)

IMO Resolution A.694(17)	IEC 61023 Ed. 3.0: 2007
IMO Resolution A.824(19)	IEC 60945 Ed. 4.0: 2002 incl. Corr. 1: 2008
IMO Resolution MSC.36(63)	IEC 61162-1 Ed. 5.0: 2016
IMO Resolution MSC.97(73)	IEC 62288 Ed. 2.0: 2014
IMO Resolution MSC.191(79)	
IMO Resolution MSC.302(87)	

(title and/or number and date of issue of the standard(s) or other normative document(s))

For assessment, see

- EC Type Examination (Module B) certificate No. MEDB00000HG Rev.1 issued by DNV GL AS (0575), Norway.
- Product Quality System (Module D) certificate No. P 112 (Issue 46) issued by Telefication, The Netherlands.

This declaration is issued according to the Directive 2014/90/EU of the European Parliament and of the Council on marine equipment, and the Implementing Regulation (EU) 2019/1397.

On behalf of Furuno Electric Co., Ltd.

Nishinomiya City, Japan
July 29, 2020

(Place and date of issue)

Yoshitaka Shogaki
Department General Manager
Quality Assurance Department

(name and signature or equivalent marking of authorized person)