

FURUNO

OPERATOR'S MANUAL

SATELLITE SPEED LOG

Model

GS-100

ECF

(Elemental Chlorine Free)

The paper used in this manual
is elemental chlorine free.

FURUNO ELECTRIC CO., LTD.

9-52 Ashihara-cho,
Nishinomiya, 662-8580, JAPAN

• FURUNO Authorized Distributor/Dealer

All rights reserved. Printed in Japan

Pub. No. OME-72790-L

(GREG) GS-100

A : MAY 2014

L : SEP. 16, 2021



0 0 0 1 9 8 5 1 3 1 0

IMPORTANT NOTICE

General

- This manual has been authored with simplified grammar, to meet the needs of international users.
- The operator of this equipment must read and follow the descriptions in this manual. Wrong operation or maintenance can void the warranty or cause injury.
- Do not copy any part of this manual without written permission from FURUNO.
- If this manual is lost or worn, contact your dealer about replacement.
- The contents of this manual and the equipment specifications can change without notice.
- The example screens (or illustrations) shown in this manual can be different from the screens you see on your display. The screens you see depend on your system configuration and equipment settings.
- Save this manual for future reference.
- Any modification of the equipment (including software) by persons not authorized by FURUNO will void the warranty.
- The following concern acts as our importer in Europe, as defined in DECISION No 768/2008/EC.
 - Name: FURUNO EUROPE B.V.
 - Address: Ridderhaven 19B, 2984 BT Ridderkerk, The Netherlands
- The following concern acts as our importer in UK, as defined in SI 2016/1025 as amended SI 2019/470.
 - Name: FURUNO (UK) LTD.
 - Address: West Building Penner Road Havant Hampshire PO9 1QY, U.K.
- All brand, product names, trademarks, registered trademarks, and service marks belong to their respective holders.

How to discard this product

Discard this product according to local regulations for the disposal of industrial waste. For disposal in the USA, see the homepage of the Electronics Industries Alliance (<http://www.eiae.org/>) for the correct method of disposal.

How to discard a used battery

Some FURUNO products have a battery(ies). To see if your product has a battery, see the chapter on Maintenance. If a battery is used, tape the + and - terminals of the battery before disposal to prevent fire, heat generation caused by short circuit.

In the European Union

The crossed-out trash can symbol indicates that all types of batteries must not be discarded in standard trash, or at a trash site. Take the used batteries to a battery collection site according to your national legislation and the Batteries Directive 2006/66/EU.

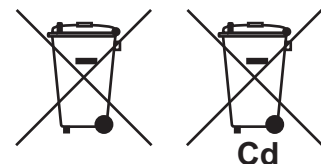

In the USA

The Mobius loop symbol (three chasing arrows) indicates that Ni-Cd and lead-acid rechargeable batteries must be recycled. Take the used batteries to a battery collection site according to local laws.

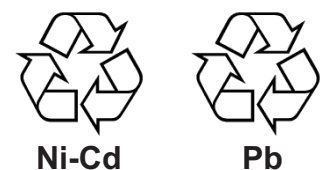

In the other countries

There are no international standards for the battery recycle symbol. The number of symbols can increase when the other countries make their own recycle symbols in the future.



SAFETY INSTRUCTIONS



WARNING

Indicates a condition that can cause death or serious injury if not avoided.



CAUTION

Indicates a condition that can cause minor or moderate injury if not avoided.



Warning, Caution



Prohibitive Action



Mandatory Action

Safety Instructions for the Operator



WARNING



Do not disassemble or modify the equipment.

Fire, electrical shock or serious injury can occur.



Turn off the power immediately if water leaks into the equipment or smoke or fire is coming from the equipment.

Failure to turn off the equipment can cause fire or electrical shock. Contact a FURUNO agent for service.



Use the correct fuse.

A wrong fuse can cause fire or serious damage to the equipment.



CAUTION



Handle the display carefully.

Injury can result if the display breaks.



Do not connect/disconnect the signal cable while turning the power on.

The unit may be damaged.







No single navigation aid (including this unit) should ever be relied upon as the exclusive means for navigating your vessel.

The navigator is responsible for checking all aids available to confirm his position. Electronic aids are intended to assist, not replace, the navigator.

About the TFT LCD

The TFT LCD is constructed using the latest LCD techniques, and displays 99.99% of its pixels. The remaining 0.01% of the pixels may drop out or blink, however this is not an indication of malfunction.

Safety Instructions for the Installer

 WARNING	
	<p>Have a qualified serviceman do the installation.</p> <p>Only qualified personnel should work inside the equipment.</p>
	<p>Turn off the power at the switchboard before beginning the installation.</p> <p>Fire or electrical shock can result if the power is left on.</p>
	<p>Use the specified power cable.</p> <p>Fire can result if an incorrect cable is used.</p>
	<p>Be sure that the power supply is compatible with the voltage rating of the equipment.</p> <p>Connection of an incorrect power supply can cause fire or damage the equipment.</p>



 CAUTION																												
	<p>Ground the equipment to prevent electrical shock and mutual interference.</p>																											
	<p>The mounting location for the units must satisfy the following conditions:</p> <ul style="list-style-type: none"> - Away from rain and water splash - Out of direct sunlight - Away from air conditioner vents - Moderate and stable in temperature and humidity 																											
<p>Observe the following compass safe distances to prevent interference to a magnetic compass:</p>																												
	<table border="1"> <thead> <tr> <th></th> <th>Type</th> <th>Standard compass</th> <th>Steering compass</th> </tr> </thead> <tbody> <tr> <td>Display Unit</td> <td>GS-1001B</td> <td>0.70 m</td> <td>0.45 m</td> </tr> <tr> <td>Antenna Unit</td> <td>GS-1002</td> <td>0.60 m</td> <td>0.40 m</td> </tr> <tr> <td>Junction Box</td> <td>GS-1003</td> <td>0.75 m</td> <td>0.50 m</td> </tr> <tr> <td>Display Unit (option)</td> <td>DS-600</td> <td>0.60 m</td> <td>0.40 m</td> </tr> <tr> <td rowspan="2">AC/DC Power Supply Unit</td> <td>PR-240</td> <td>0.90 m</td> <td>0.60 m</td> </tr> <tr> <td>PR-241</td> <td>0.85 m</td> <td>0.55 m</td> </tr> </tbody> </table>		Type	Standard compass	Steering compass	Display Unit	GS-1001B	0.70 m	0.45 m	Antenna Unit	GS-1002	0.60 m	0.40 m	Junction Box	GS-1003	0.75 m	0.50 m	Display Unit (option)	DS-600	0.60 m	0.40 m	AC/DC Power Supply Unit	PR-240	0.90 m	0.60 m	PR-241	0.85 m	0.55 m
	Type	Standard compass	Steering compass																									
Display Unit	GS-1001B	0.70 m	0.45 m																									
Antenna Unit	GS-1002	0.60 m	0.40 m																									
Junction Box	GS-1003	0.75 m	0.50 m																									
Display Unit (option)	DS-600	0.60 m	0.40 m																									
AC/DC Power Supply Unit	PR-240	0.90 m	0.60 m																									
	PR-241	0.85 m	0.55 m																									

TABLE OF CONTENTS

FOREWORD	vii
SYSTEM CONFIGURATIONS	ix
EQUIPMENT LISTS	x
1. OPERATIONAL OVERVIEW	1-1
1.1 Controls	1-1
1.2 How to Turn the Power On/Off	1-3
1.3 How to Adjust the Brilliance of the Display and Panel	1-4
1.4 Main Menu Overview	1-5
1.5 List Overview	1-6
2. DISPLAYS	2-1
2.1 Display Modes	2-1
2.2 How to Select the Background Color	2-2
2.3 Navigation Display	2-2
2.4 Integrity Display	2-5
3. SETTINGS	3-1
3.1 Display Menu	3-1
3.1.1 How to set the time for smoothing	3-1
3.1.2 How to set the current direction and wind angle	3-1
3.1.3 How to use the "cm/sec" display	3-2
3.2 Trip Menu	3-3
3.2.1 How to calculate the trip distance	3-3
3.2.2 How to set the total distance	3-3
3.3 System Menu	3-4
3.3.1 How to change the user password	3-4
3.3.2 SNTP setting	3-5
3.4 How to Set the Demo Mode	3-5
3.5 GNSS Menu	3-7
3.5.1 How to set the positioning condition	3-7
3.6 Other Setting Menus for Antenna Unit	3-8
3.6.1 How to reset the sensor	3-8
3.6.2 How to clear the sensor settings	3-8
3.6.3 How to set the time for dead reckoning	3-8
3.6.4 How to restart heading data output after restoration of heading data	3-9
3.7 Device List	3-9
3.7.1 How to open the device list from the menu	3-9
3.7.2 Device menu	3-10
3.8 I/O Menu	3-11
3.8.1 How to set the output data 1, 2, 3 or 4	3-11
3.8.2 How to set the sentences to output to the Ethernet	3-12
3.8.3 How to select the input data	3-13
3.8.4 Line monitor log	3-14
3.8.5 How to set the digit number for sentences	3-16
3.9 How to Clear the Memory	3-16
4. NOTICES	4-1
4.1 Audio Notice Type	4-1
4.2 Ship Speed Notice	4-1
4.3 Trip Notice	4-2

5. ALERTS	5-1
5.1 Overview.....	5-1
5.1.1 What is an Alert?	5-1
5.2 Alert List.....	5-3
5.3 Alert Log	5-4
5.4 How to Acknowledge Alerts.....	5-4
5.5 Responsibility Transfer Alert.....	5-5
6. BERTHING DISPLAY	6-1
6.1 Berthing Display for the GS-100.....	6-1
6.2 Controls for the Display Unit DS-600.....	6-3
6.3 Various Settings	6-4
6.4 Display Range	6-7
6.4.1 How to select a range.....	6-7
6.4.2 How to pre-set ranges	6-8
6.5 Track.....	6-8
6.5.1 Types of tracks	6-8
6.5.2 How to select the type of track to display	6-9
6.5.3 How to select the past track format	6-10
6.5.4 How to select the predicted track plot interval.....	6-10
6.6 How to Show, Hide Navigation Data and 3-axis Speed Data.....	6-10
6.7 Berthing Line	6-11
6.7.1 How to register a berthing line.....	6-11
6.7.2 How to edit a berthing line.....	6-13
6.7.3 How to delete a point or a line.....	6-13
6.7.4 How to send the berthing lines data to DS-600.....	6-14
7. MAINTENANCE, TROUBLESHOOTING	7-1
7.1 Maintenance.....	7-1
7.2 Fuse Replacement	7-1
7.3 Consumable Parts.....	7-2
7.4 Troubleshooting.....	7-3
7.5 Equipment Information	7-4
7.6 Self Test	7-5
7.7 Backup.....	7-7
7.8 Replacement Parts Settings.....	7-8
7.8.1 How to reset the operating time for replacement parts	7-8
7.8.2 Correction for the replaced sensor board.....	7-9
8. INSTALLATION	8-1
8.1 Mounting.....	8-1
8.1.1 Display unit GS-1002	8-1
8.1.2 Antenna unit GS-1001.....	8-3
8.1.3 Junction box GS-1003.....	8-7
8.2 Wiring	8-8
8.2.1 Junction box	8-9
8.2.2 Display unit.....	8-11
8.2.3 Antenna unit	8-12
8.2.4 How to connect the Cable Replacement Kit (OP20-50)	8-13
8.2.5 How to secure and waterproof the cable connections.....	8-16
8.3 Adjustments.....	8-17
8.3.1 Language	8-17
8.3.2 Device mode	8-17
8.3.3 Unit	8-17
8.3.4 Datum.....	8-18
8.3.5 Time format	8-18

TABLE OF CONTENTS

8.3.6	Equipment ID	8-19
8.3.7	Offset menu.....	8-19
8.3.8	Alert mode.....	8-23
8.3.9	IP address	8-24
8.4	Connections and Adjustments with Optional Interface Unit IF-2503.....	8-24
8.5	Installation, Adjustment of Optional Display Unit DS-600	8-25
8.5.1	Installation of the display unit DS-600.....	8-25
8.5.2	Menu settings for DS-600	8-27
8.5.3	Adjustments for GS-1002.....	8-30
8.6	Speed Test.....	8-30
APPENDIX 1MENU TREE		AP-1
APPENDIX 2LIST OF TERMS/SYMBOLS		AP-5
APPENDIX 3TIME DIFFERENCES		AP-10
APPENDIX 4GEODETTIC CHART LIST		AP-11
APPENDIX 5WHAT IS SBAS?		AP-12
APPENDIX 6DIGITAL INTERFACE (IEC61162-1/2/450).....		AP-13
APPENDIX 7PARTS LIST/LOCATION		AP-22
APPENDIX 8JIS CABLE GUIDE		AP-25
APPENDIX 9ALERT LIST		AP-26
APPENDIX 10DISPLAY FOR DS-600.....		AP-29
SPECIFICATIONS		SP-1
PACKING LISTS.....		A-1
OUTLINE DRAWINGS.....		D-1
INTERCONNECTION DIAGRAM		S-1
INDEX.....		IN-1

FOREWORD

A Word to the Owner of the GS-100

Congratulations on your choice of the FURUNO GS-100 Satellite Speed Log. We are confident you will see why the FURUNO name has become synonymous with quality and reliability.

Since 1948, FURUNO Electric Company has enjoyed an enviable reputation for innovative and dependable marine electronics equipment. This dedication to excellence is furthered by our extensive global network of agents and dealers.

Your equipment is designed and constructed to meet the rigorous demands of the marine environment. However, no machine can perform its intended function unless properly installed and maintained. Please carefully read and follow the operation and maintenance procedures set forth in this manual.

We would appreciate feedback from you, the end-user, about where we are achieving our purposes.

Thank you for considering and purchasing FURUNO equipment.

Features

The main features of the GS-100 are as shown below.

- High-resolution color LCD
- Comprehensive navigation data displays
- Highly accurate speed data
- External USB memory capability (for maintenance)
- Vessel speed for port and starboard at any position of the hull by built-in satellite compass
- Optional DS-600 (display unit) can be connected to the GS-100 to add berthing support capability
- Notices: Ship speed, Trip
- Alerts: Warning, Caution
- Ethernet port for connection to a LAN

Software used in this product

This equipment uses the following open source software.

This product includes software to be licensed under the GNU General Public License (GPL) version 2.0, GNU Lesser General Public Software License (LGPL) version 2.0, Apache, BSD and others. The program(s) is/are free software(s), and you can copy it and/or redistribute it and/or modify it under the terms of the GPL version 2.0 or LGPL version 2.0 as published by the Free Software Foundation. Please access to the following URL if you need source codes:
https://www.furuno.co.jp/en/contact/cnt_oss_e01.html

Program No.

Unit	Name	No.
GS-1001B	GNSS	48505230**
	OS	2051590-01.**
	APL	2051591-01.**
GS-1002	Boot	2051551-02.**
	APL	2051552-04.**
DS-600	Starter	6652000-01.**
	Booter	6652001-02.**
	Main	6652002-02.**

** : Minor change

CE declaration

With regards to CE declarations, please refer to our website (www.furuno.com) for further information about RoHS conformity declarations.

SYSTEM CONFIGURATIONS

Basic configuration is shown with solid line.

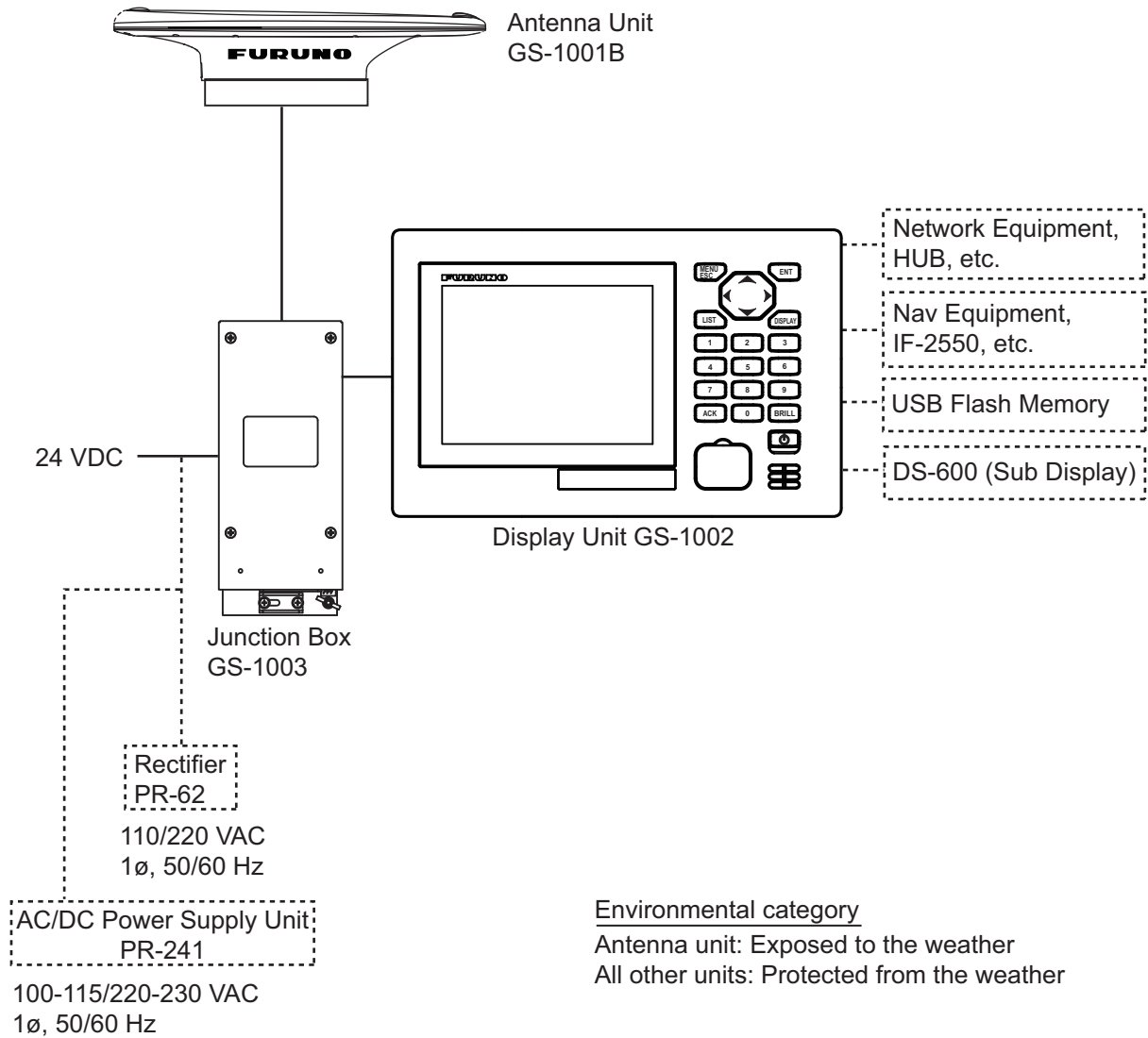

EQUIPMENT LISTS

Standard supply

Name	Type	Code No.	Qty	Remarks
Antenna Unit	GS-1001B-A	-	Select one	For GNSS (GPS, GLONASS, Galileo, QZSS) For cable 30/40/50m with armor
	GS-1001B-N	-		For GNSS (GPS, GLONASS, Galileo, QZSS) For cable 15/30m without armor
Display Unit	GS-1002	-	1	
Junction Box	GS-1003	-	1	
Installation Materials	CP20-03503	001-531-980	Select one	For Antenna Unit
	CP20-03502	001-265-740		
	CP20-03600	000-024-964	1	For Display Unit
	CP20-03701	001-265-650	1	For Junction Box
	CP20-03820	000-024-980	Select one	30 m cable, w/armor
	CP20-03830	000-024-981		40 m cable, w/armor
	CP20-03840	000-024-982		50 m cable, w/armor
	CP20-03870	000-035-909		15 m cable, w/o armor
CP20-03880	000-035-910	30 m cable, w/o armor		
Spare Parts	SP20-01501	001-265-820	1	For Junction Box (See the packing list at the back of this manual.)
Accessories	FP20-01100	000-042-239	1	LCD Cleaning Cloth for display unit (Type: 19-028-3125-6, Code No.: 100-360-676-10)

Optional supply

Name	Type	Code No.	Qty	Remarks
Flush Mount Kit	OP20-40	001-243-890	1	For S-type
Flush Mount Kit	OP20-41	001-243-900	1	For F-type
Rectifier	PR-62	-	1	For 110/220 VAC
AC/DC Power Supply Unit	PR-241	-	1	For 100 to 230 VAC
Interface Unit	IF-2550	-	1	
Ferrite Core	OP86-11	001-594-450	1	For PR-241.
Bird-Repellent Fixture	OP20-36	004-380-830	1	Four pieces
	OP20-37	004-380-840	1	Single.
Display Unit	DS-600-S	-	1	
Bracket Assembly with Knobs	OP26-8	000-016-313	1	For DS-600-S

Name	Type	Code No.	Qty	Remarks
Cable Conversion kit	OP20-50	001-506-810	1	Replacement kit for GS-1001 (MJ-A10SPF0015-xxxC) <u>Contents</u> - Waterproof relay box (JPBS 06) - 120 Ω Lead resistance (03S9939) - FRU-NMEA-PFF-060 - Vinyl tape (0.2X19X10000MM Black, 000-172-691-10) - Self-bonding tape (No.15, 000-174-646-10)
Cable Assy.	MJ-A6SPF0003-050C	000-154-054-10	1	5 m, For DATA1, 2 or 3
	MJ-A6SPF0011-050C	000-159-690-10	1	5 m, For DATA1, 2 or 3
	MJ-A6SPF0011-100C	000-159-691-10	1	10 m, For DATA1, 2 or 3
	MJ-A6SPF0011-200C	001-244-120	1	20 m, For DATA1, 2 or 3
	MJ-A6SPF0012-050C	000-154-053-10	1	5 m, For DATA1, 2 or 3
	MJ-A6SPF0012-100C	000-154-037-10	1	10 m, For DATA1, 2 or 3
	MJ-A6SPF0012-200C	001-244-130	1	20 m, For DATA1, 2 or 3
	MJ-A7SPF0003-050C	000-159-688-10	1	5 m, For DATA 4
	MOD-WPAS0001-030+	000-164-609-10	1	3 m, Between Display Unit and Switching Hub
	M12-05BFFM-060	001-105-800-10	1	6 m, Between Display Unit and Junction Box
	MJ-A3SPF0015-060C	001-265-430	1	6 m, For power
	MJ-A10SPF0016-010C	001-266-040	1	1 m, For Antenna Unit
	80-580-0008	000-193-291-10	1	0.3m, In-line terminator For cable w/armor
	ANT-DN18WAPVC-300	001-277-330	1	30 m, w/armor, Between An- tenna Unit and Junction Box
	ANT-DN18WAPVC-400	001-277-340	1	40 m,w/armor, Between An- tenna Unit and Junction Box
	ANT-DN18WAPVC-500	001-277-350	1	50 m,w/armor, Between An- tenna Unit and Junction Box
	MJ-A10SPF0015-150C	000-166-891-11	1	15 m, w/o armor, Between Antenna Unit and Junction Box For GS-1001-N
	MJ-A10SPF0015-300C	000-166-892-11	1	30 m, w/o armor, Between Antenna Unit and Junction Box For GS-1001-N
	FRU-NMEA-NFF-R15	000-194-637-11	1	15 m, w/o armor, Between Antenna Unit and Junction Box For GS-1001B
	FRU-NMEA-NFF-R30	000-194-638-11	1	30 m, w/o armor, Between Antenna Unit and Junction Box For GS-1001B

This page is intentionally left blank.

1. OPERATIONAL OVERVIEW

1.1 Controls

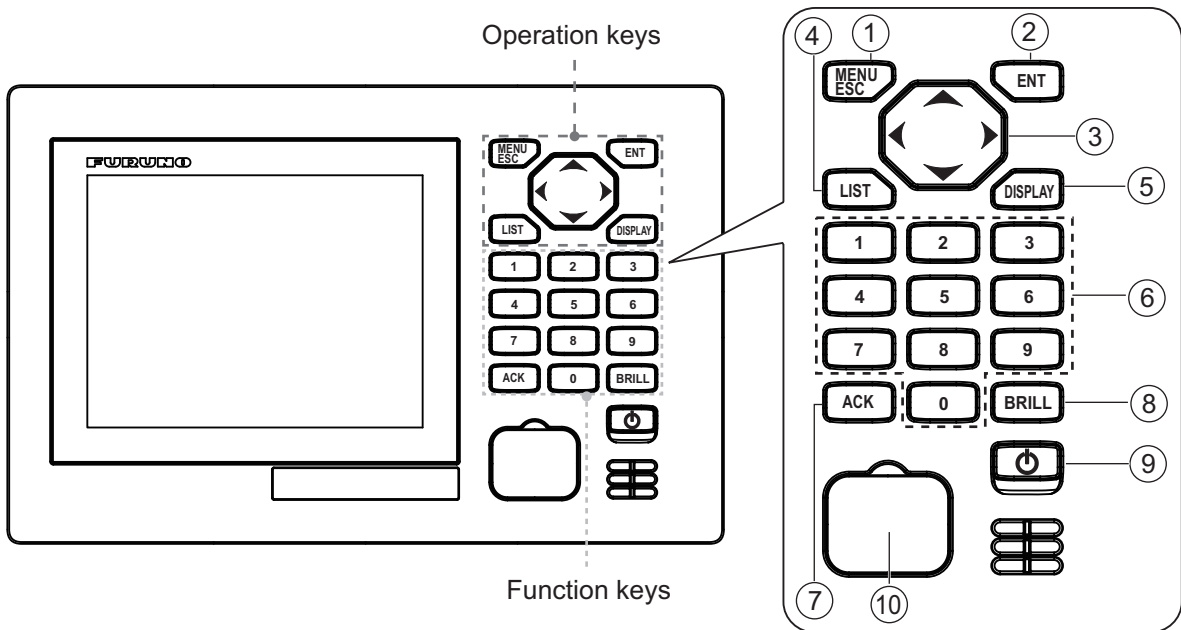

The keys are arranged according to the function.

No.	Key	Function	
		Menu screen	Display mode
1	MENU ESC	<p><u>Short press</u></p> <ul style="list-style-type: none"> Closes the menu. Quits current operation. <p><u>Long press</u></p> <p>Closes all menus and pop-up windows, then opens the [Alert List].</p> <p>Note: In the following situations, the [Alert List] is not shown. Close the pop-up or menu first, then press and hold the MENU ESC key.</p> <ul style="list-style-type: none"> Buzzer volume window is shown; Memory I/O menu is shown; Keyboard Test screen is shown; LCD Test screen is shown; Loading screen is shown; Restart confirmation screen is shown; A screen requiring user input is shown; Timeout message is shown; Program information screen is shown. 	Opens the menu.
2	ENT	Confirms a selection.	Switches the screen between main (digital navigation data) and sub (graphic screen).

1. OPERATIONAL OVERVIEW

No.	Key	Function	
		Menu screen	Display mode
3	Cursorpad	<ul style="list-style-type: none"> ▲ or ▼: Select the menu item. ◀: Returns one layer in multi-layer menu. ▶: Go to one layer in multi-layer menu. 	▲ or ▼: Switches display on the integrity display.
4	LIST	<ul style="list-style-type: none"> Opens the list. Switches the list (any display → active alert → alert log → device list → any display). Long-press to switch the list in reverse order. 	
5	DISPLAY	Opens the display mode.	Switches the screen between THD and SDME modes.
6	0 to 9	<ul style="list-style-type: none"> Selects and confirms the menu item. Enters a numeric character. 	<ul style="list-style-type: none"> Long-press 0 key to reset the trip distance. Long-press 1 key to switch the unit of the own ship's speed between [cm/sec] and [Preset Unit] set in subsection 8.3.3.
7	ACK	Acknowledges an unacknowledged alert when the pop-up appears.	
8	BRILL	Opens the brilliance adjustment window. Adjusts the display brilliance when the adjustment window is open.	
9	 (Power)	Turn the power on and off.	
10	USB port	For connection of USB flash memory.	

Key sound

When you operate a key, a single beep sounds. If you do not need the key beep, deactivate the beep sound as follows (see section 1.4):

1. Press the **MENU ESC** key to open the main menu.
2. Select [2 Speed/Trip Setting] then [4 Sound].
3. Select [2 Key Sound].
4. Select [2 Off].
5. Press the **MENU ESC** key to close the main menu.

1.2 How to Turn the Power On/Off

Press the  key to turn the display unit on. The start-up screen appears for 30 seconds then the screen set at the [6 Device Mode] menu (see subsection 8.3.2) appears.



Note: The screen refreshes slower in low ambient temperature.

To turn the display unit off, press the  key.

Antenna unit power is turned on/off at the ship's mains.

1.3 How to Adjust the Brilliance of the Display and Panel

1. Press the **BRILL** key to show the following setting window.

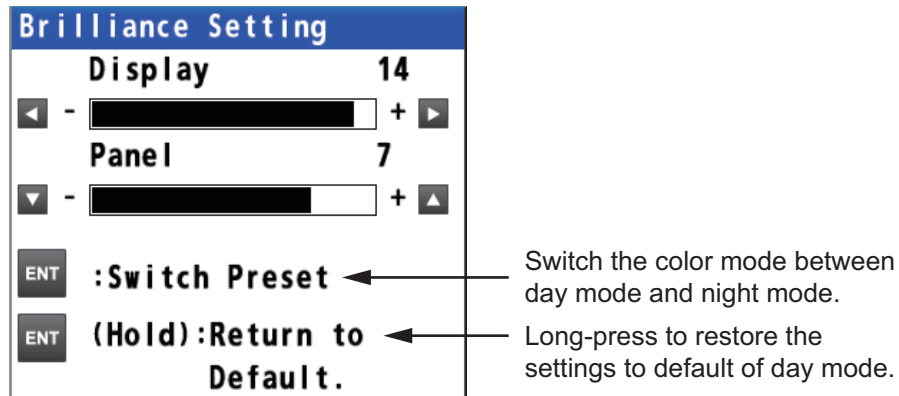

2. To adjust the display brilliance, press the cursorpad (◀ or ▶) or the **BRILL** key (setting range: 0 to 15, default: 14 for day mode/6 for night mode).
3. To adjust the panel brilliance, press the cursorpad (▲ or ▼) (setting range: 0 to 9, default: 7 for day and night modes).
4. Press the **MENU ESC** key to close the setting window.

Note 1: The default settings for night mode is 6 for [Display] and 7 for [Panel]. If the display is difficult to see when switching to the night mode, press the cursorpad (▶) to increase the display brilliance.

Note 2: When you switch the brilliance mode, the last-used brilliance for the selected mode is set.

Note 3: When the brilliance is preset, the background color is also preset (see section 2.2). So both the brilliance and the background color are restored to the default when long-pressing the **ENT** key.

1.4 Main Menu Overview

1. Press the **MENU ESC** key to open the main menu.

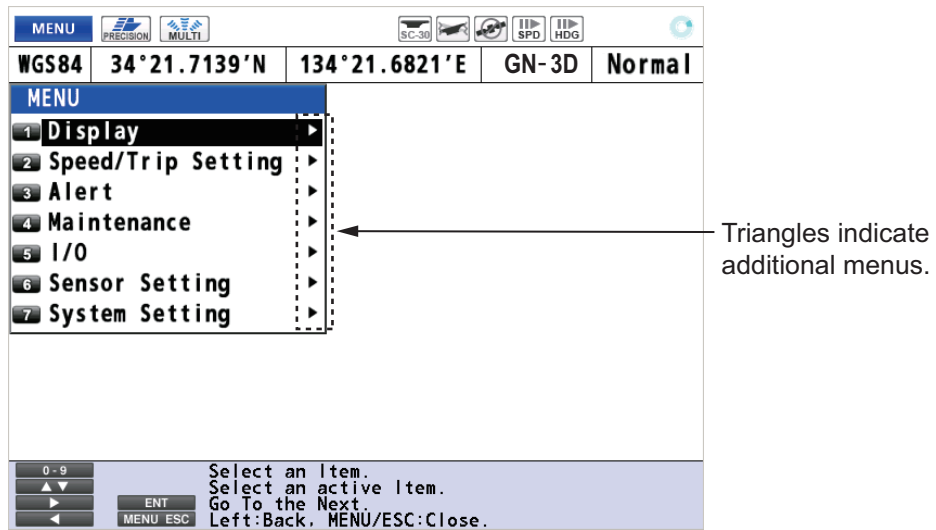

2. Press the cursorpad (**▲** or **▼**) to select a menu item then press the **ENT** key. You can also select a menu item by pressing the numeric keys. This manual states this operating procedure as “Select [No. menu name].” The menu items that have a **▶** indicate additional menus.

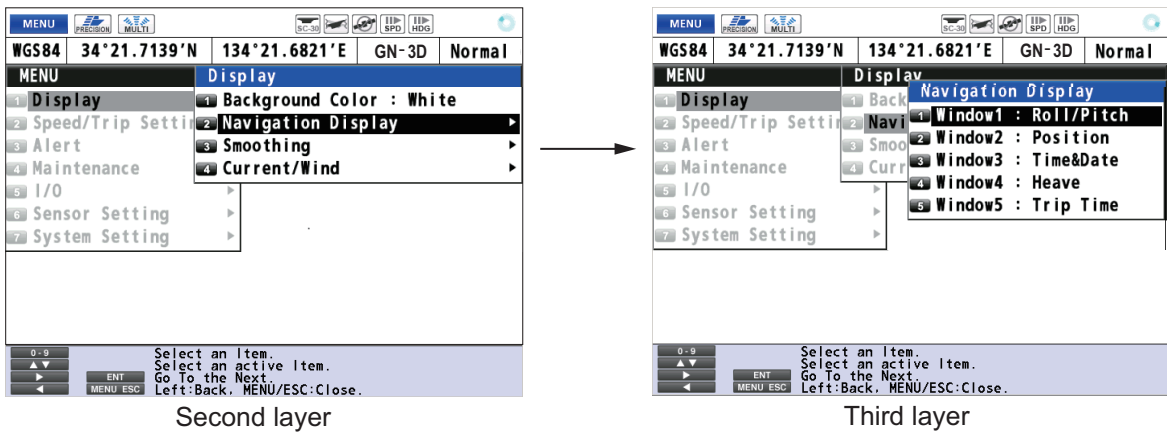

3. Select an option.
4. Press the **MENU ESC** key to close the main menu.

1.5 List Overview

The **LIST** key displays the active alert list, alert log list and device list, in the sequence shown below.

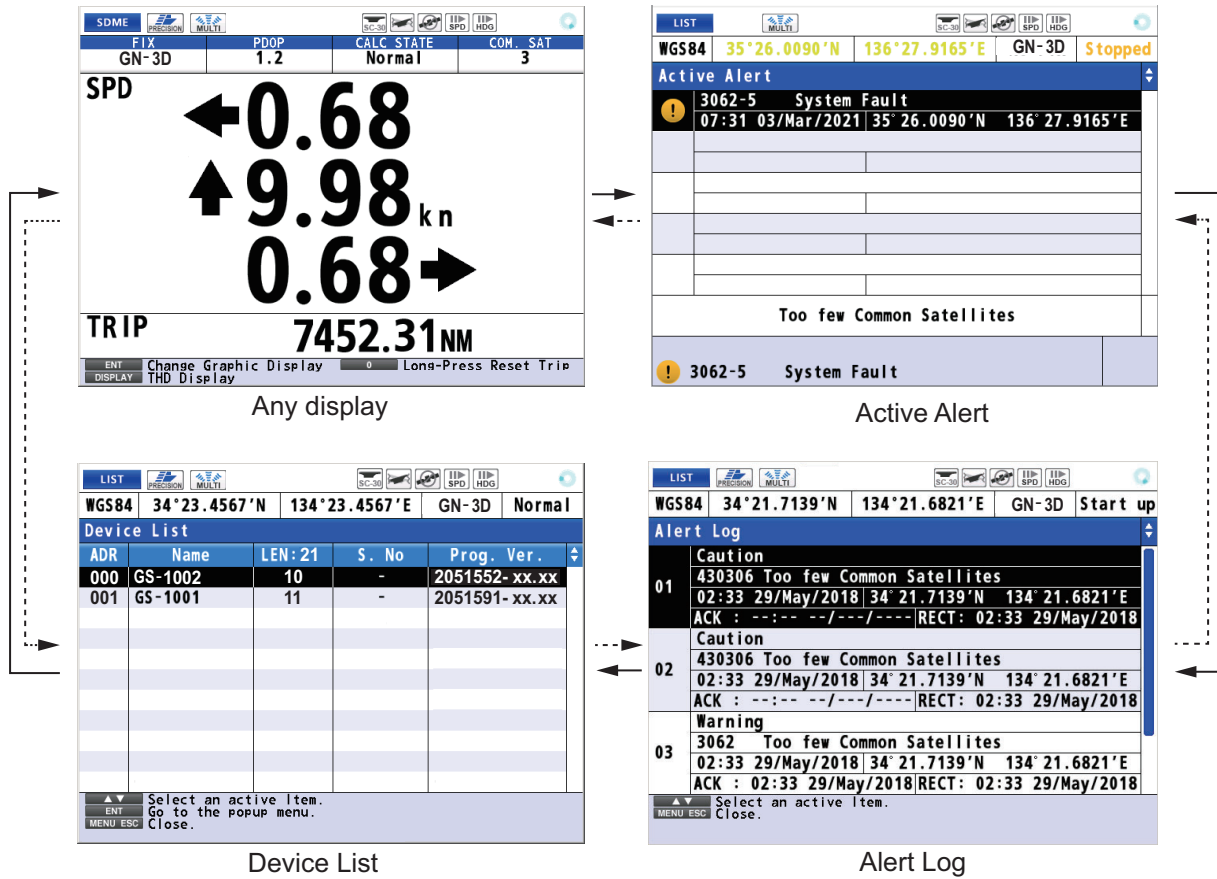

→ : Short-press the **LIST** key
→ : Long-press the **LIST** key

2. DISPLAYS

2.1 Display Modes

The GS-100 has two main display modes. The SDME (Speed and Distance Measuring Equipment) mode measures speed and distance. The THD (Transmitting Heading Device) outputs heading data to external equipment. You can switch between the two display modes with the **DISPLAY** key. The mode is indicated at the top left corner as follows:

Indication	Description
	Mode selected on the [Device Mode]* menu.
	Top: Currently selected mode. Bottom: Mode selected on the [Device Mode]* menu.

*: See subsection 8.3.2.

Each mode has a main (digital navigation data) and sub (graphic) display, and you can switch between them with the **ENT** key. For a description of the sub displays, see sections 2.3 and 2.4.

The example below shows sample screens when the SDME mode is the “Device Mode”. The screens for the THD mode are similar.

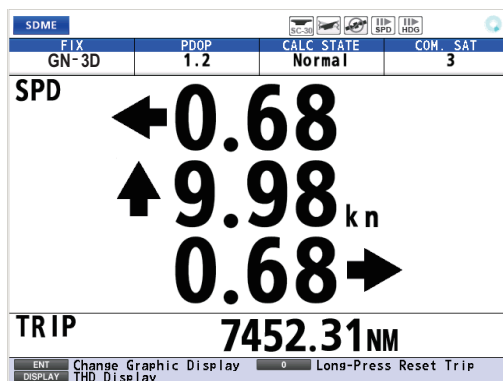

Main (digital navigation data)

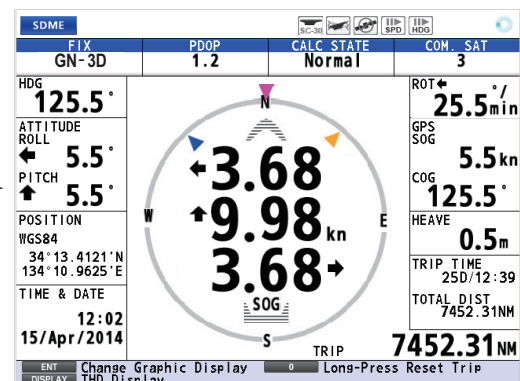

Sub (graphic screen: Navigation)

Press the ENT key.

Press the DISPLAY key.

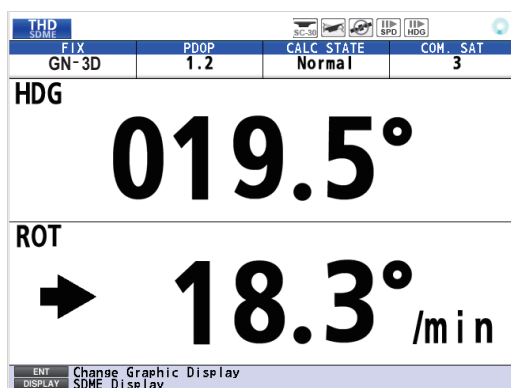

Main (digital navigation data)

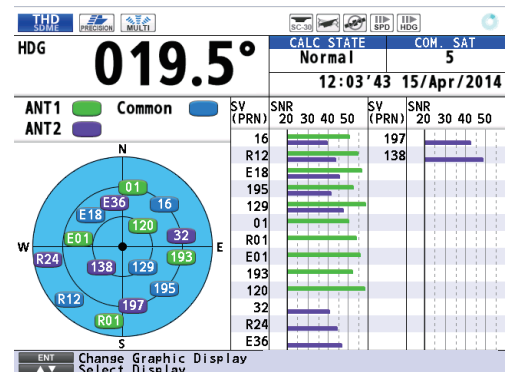

Sub (graphic screen: Integrity)

Press the ENT key.

The trip distance can be reset from the main screen of the SDME mode. Long-press (more than one second) the **0** key to reset the trip distance.

2.2 How to Select the Background Color

You can select the background color to suit lighting conditions or environment (see section 1.3).

1. Press the **MENU ESC** key to open the main menu.
2. Select [1 Display] then [1 Background Color].



3. Select [1 White] or [2 Black].
4. Press the **MENU ESC** key to close the main menu.

2.3 Navigation Display

The navigation display in the SDME mode shows various navigation data.

How to select the data to display

You can select the data to display on the windows 1 to 5.

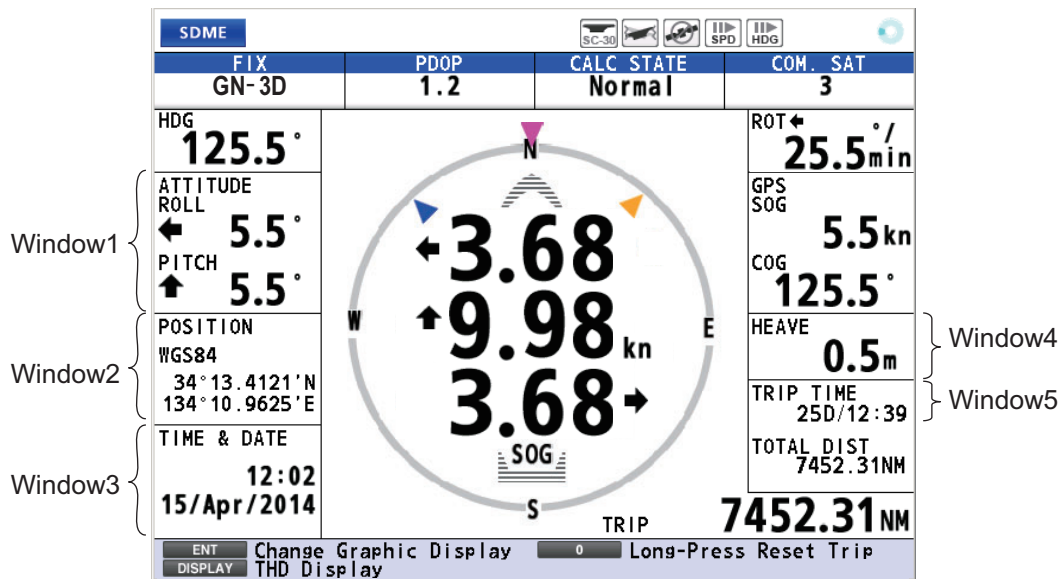

1. Press the **MENU ESC** key to open the main menu.
2. Select [1 Display] then [2 Navigation Display].

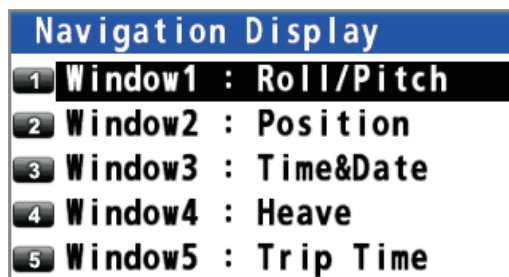

3. Select [1 Window1].

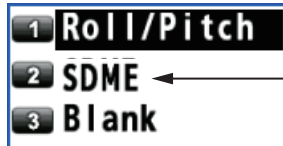

Displays external input data for doppler SOG/COG.

4. Select [1 Roll/Pitch], [2 SDME] or 3 [Blank].
5. Select the options for windows 2 to 5 as well.



Window1



Window2



Window3



Window4



Window5

Atm: Atmospheric pressure
Temp: Air temperature

Note: The options [SDME], [Current], [Wind] and [Depth] require appropriate external sensors.

6. Press the **MENU ESC** key to close the main menu.

Calculation state (Start up, Normal, DR (Dead-Reckoning), Stopped (HDG stopped), SYS FAULT (System fault))

Satellite number common to ANT1 and ANT2

Spinner rotates when the equipment is functioning normally.

Rate of turn (→: Starboard) (←: Port)

GNSS speed over ground and course over ground

Heave

Trip time

Total distance

Trip distance

HDOP: 2D
PDOP: 3D

See page AP-8.

SDME	FIX	PDOP	CALC STATE	COM. SAT
GN-3D	1.2	Normal	3	

HDG: 125.5°

ATTITUDE ROLL: 5.5° (←: Starboard, →: Port)

PITCH: 5.5° (↑: Up, ↓: Down)

POSITION WGS84: 34°13.4121'N, 134°10.9625'E

TIME & DATE: 12:02, 15/Apr/2014

ROT: 25.5°/min (→: Starboard, ←: Port)

GPS SOG: 5.5kn

COG: 125.5°

HEAVE: 0.5m

TRIP TIME: 25D/12:39

TOTAL DIST: 7452.31NM

TRIP: 7452.31NM

ENT Change Graphic Display 0 Long-Press Reset Trip
DISPLAY THD Display

[Roll/Pitch], [Position], [Time&Date], [Heave] or [Trip Time] selected

2. DISPLAYS

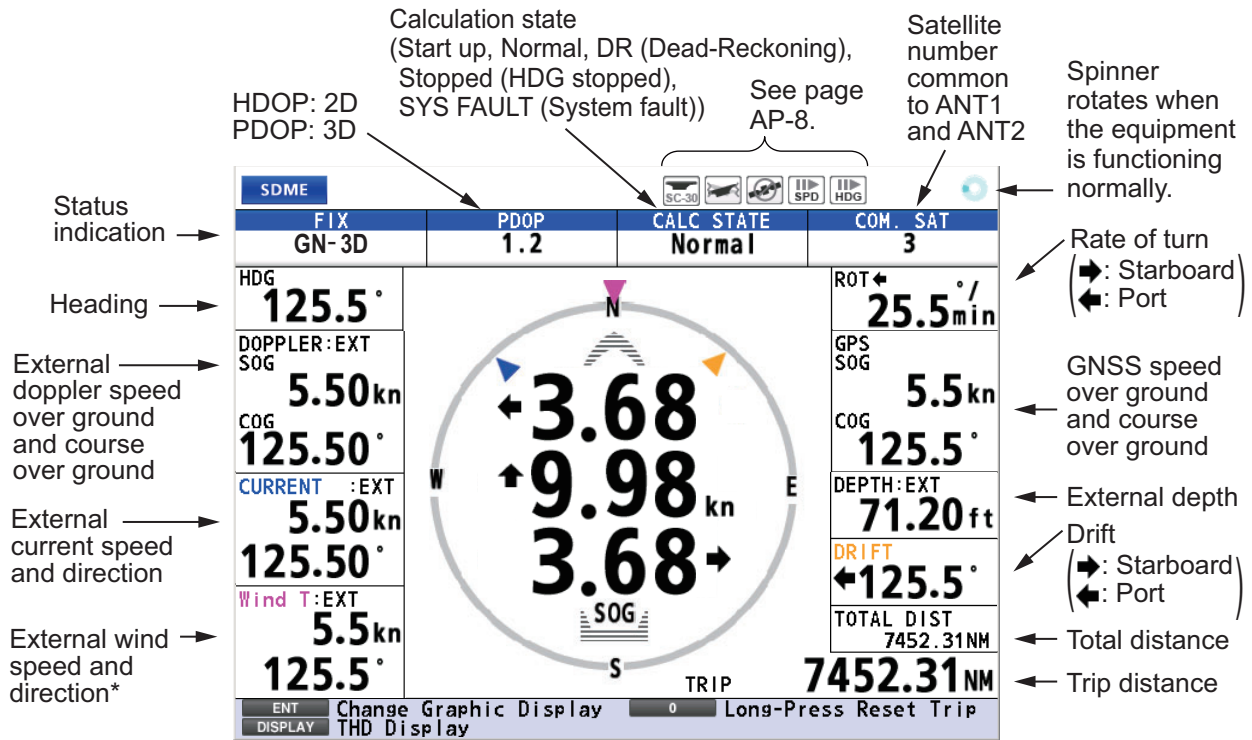

* [WIND T]: True, [WIND TH]: Theoretical, [WIND R]: Relative (See paragraph 3.1.2.)

[SDME], [Current], [Wind], [Depth] or [Drift] selected

Note: When there is no external input or the input value is invalid, the applicable window is blank. When the input value is valid, ":EXT" is displayed.

Status indications

No.	Indication		System
	2D positioning	3D positioning	
1	GP-2D	GP-3D	GPS
2	GP-S2D	GP-S3D	GPS + SBAS
3	GN-2D	GN-3D	Multi
4	GN-S2D	GN-S3D	Multi + SBAS
5	No Fix		No fixed

3-axis speed display

The circle at the center of the display shows the own ship's speed.

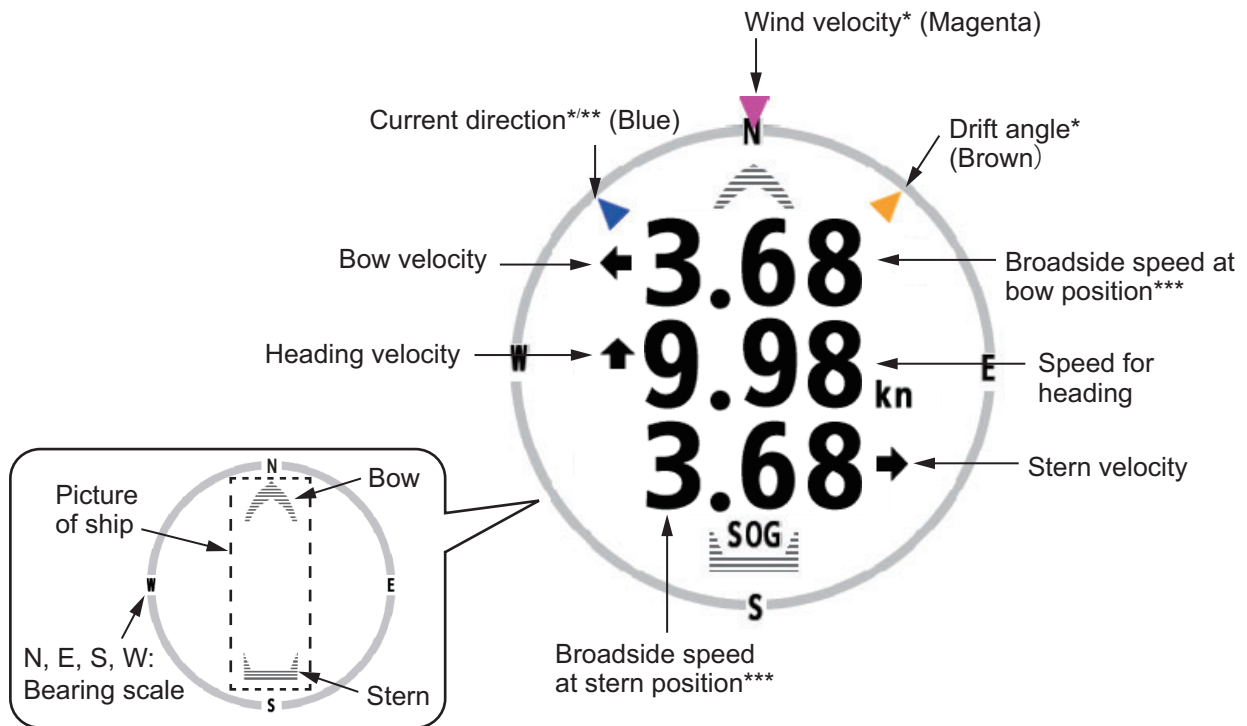

*: These triangles are displayed in the following conditions:

- Current direction: Selected [Current] in the [Window2] menu.
- Wind velocity: Selected [Wind] in the [Window3] menu.
- Drift angle: Selected [Drift] in the [Window5] menu.

** : When the current indication method is [Flow from] (set on the [Current] menu, see subsection 3.1.2), the blue icon for current direction turns 180° and is displayed outside of the circle.

***: The speed value at the position where the antenna is installed is more accurate.

2.4 Integrity Display

The integrity display, available in the THD mode, provides information about GNSS satellite position and signal quality. There are three integrity displays: GNSS, graph for satellite angle and graph for signal noise ratio.

Use the cursorpad (▲ or ▼) to change the displays, in the following sequence.

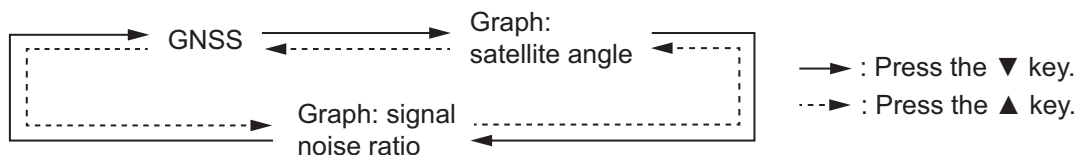

2. DISPLAYS

GNSS

The GNSS display shows the condition of satellite positioning system. Number, azimuth and elevation angle of all satellites (if applicable) in view of your receiver appear.

Satellites used for positioning (Satellite numbers used for positioning are displayed in white, or black if not used for positioning.)

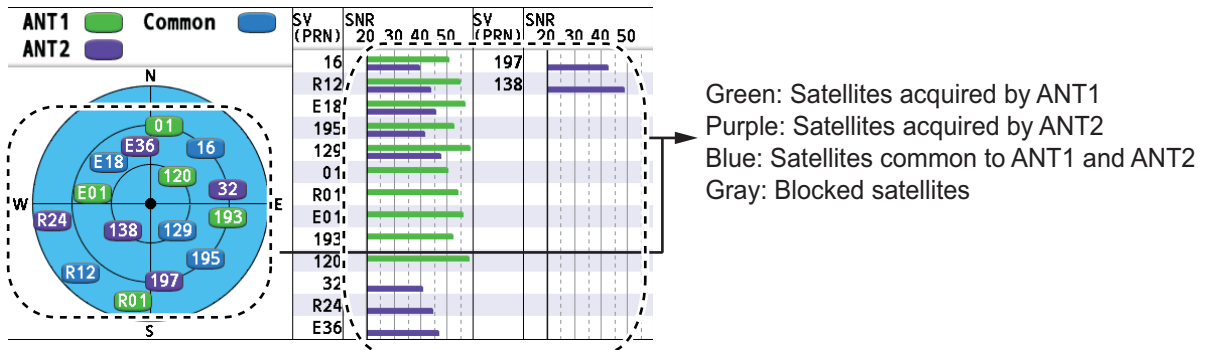
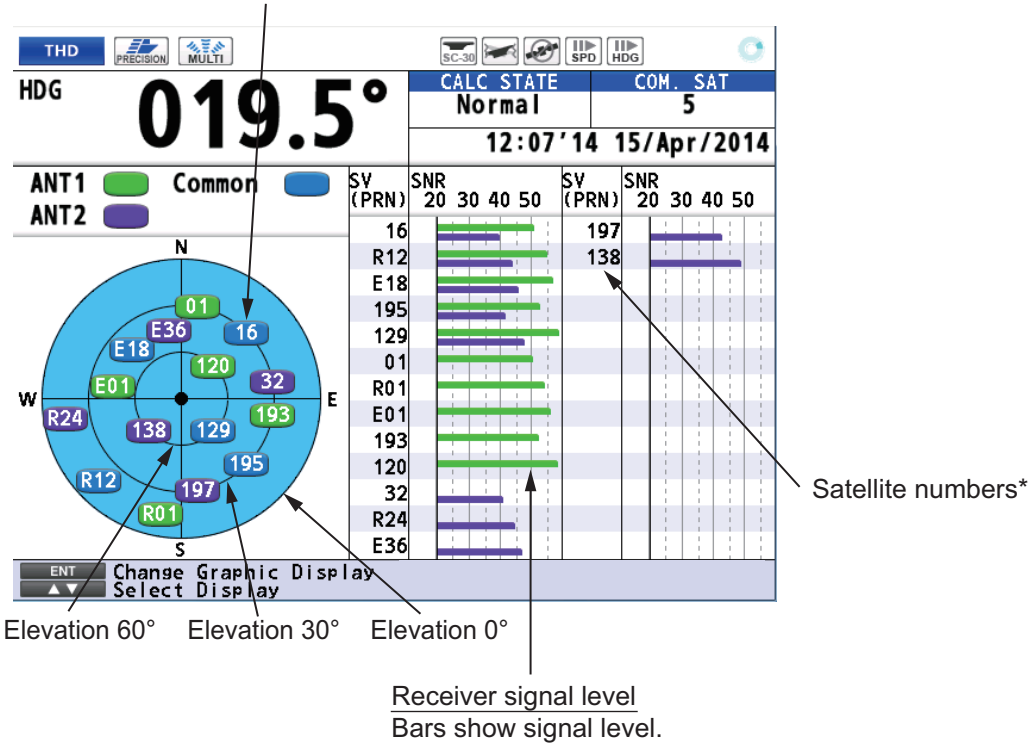

*: Satellites are displayed in order of acquisition, not numerical order.

Graphs

The graph displays show satellite angle and signal noise ratio used for positioning for the last six hours.

Satellite angle

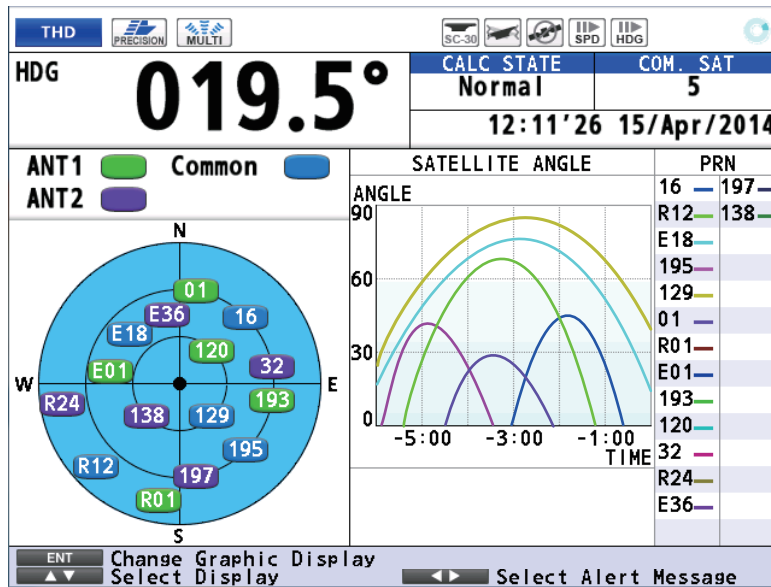

Signal noise ratio

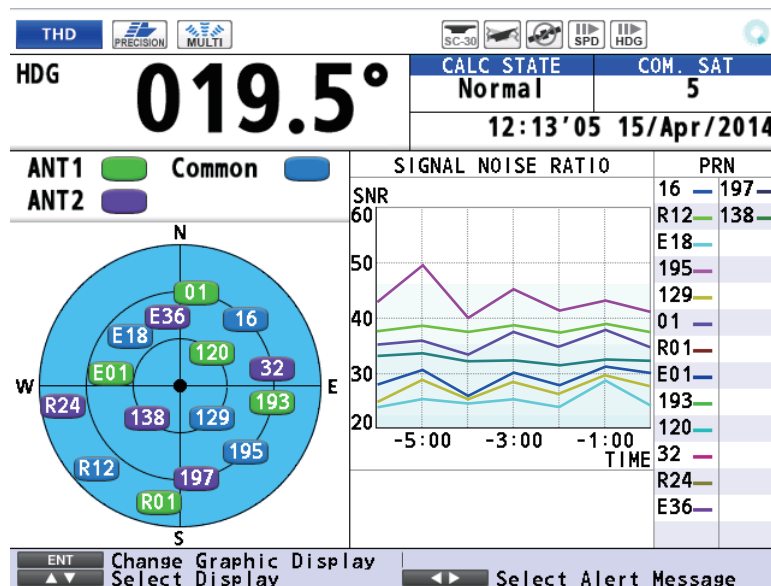

An alert (see chapter 5), which informs you to various types of errors, may appear on a graph display, with a red bar and triangle. The figure on the following page is an example of an alert on the signal noise ratio graph.

Press ◀ or ▶ to select an alert and show the alert details at the bottom of the screen. If no alert is selected by the user, the latest alert's details (alert which occurred within the last six hours) are displayed by default. The reason for the alert, the time of occurrence and the position at the time of the alert are displayed. Information shown in the first line changes according to the alert mode.

- [Alert I/F1] or [Alert I/F2]: Alert number and instance number.
- [Legacy]: Alert name.

2. DISPLAYS

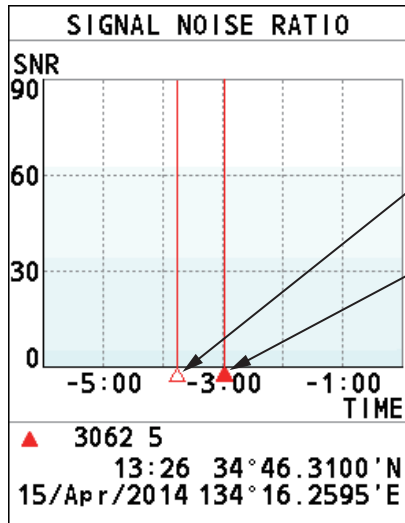

A hollow triangle marks an alert that occurred within the past six hours.

Filled red triangle marks the latest alert.

Selected alert/latest alert information.

3. SETTINGS

3.1 Display Menu

3.1.1 How to set the time for smoothing

When the receiving condition is unfavorable, the GNSS fix may change randomly, even if the boat is dead in water. This change can be reduced by smoothing the raw GNSS fixes. The higher the setting the more smoothed the raw data, however too high a setting slows response time to change in latitude and longitude.

1. Press the **MENU ESC** key to open the main menu.
2. Select [1 Display] then [3 Smoothing].

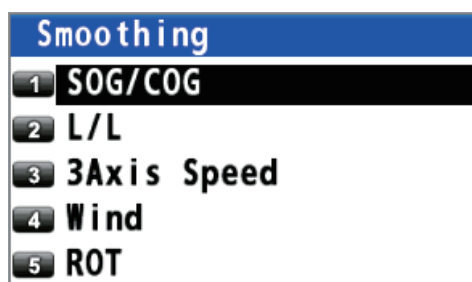

3. Select [1 SOG/COG].
4. Enter the time (unit: second) for smoothing of the antenna transmission speed with the numeric keys.
5. Move the cursor to [Enter] then press the **ENT** key.
6. Set [2 L/L], [3 3Axis Speed], [4 Wind] and [5 ROT] as well.
[L/L]: Position
[3Axis Speed]: Ship's 3-axis speed
[Wind]: Wind
[ROT]: Rate of turn
7. Press the **MENU ESC** key to close the main menu.

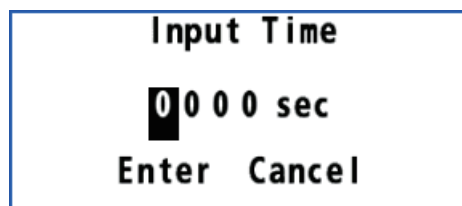

3.1.2 How to set the current direction and wind angle

Note: These functions require the external input.

1. Press the **MENU ESC** key to open the main menu.
2. Select [1 Display] then [4 Current/Wind].

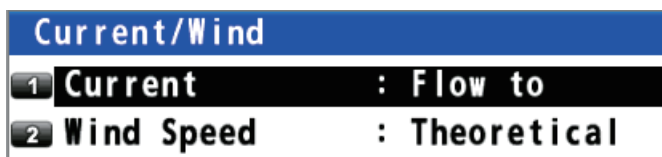

3. Select [1 Current].
4. Select [1 Flow to] or [2 Flow from].
[Flow to]: The direction of the currents is shown as flowing to.
[Flow from]: The direction of the currents is shown as flowing from.

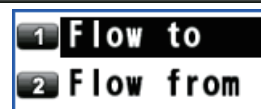

3. SETTINGS

5. Select [2 Wind Speed].
6. Select [1 True], [2 Theoretical] or [3 Relative].
[True]: The wind speed and angle minus movement of ship, reference to North.
[Theoretical]: The wind speed and angle minus movement of ship, reference to ship's bow.
[Relative]: The speed and relative direction that the wind appears to blow with ship in motion, reference to ship's bow.
7. Press the **MENU ESC** key to close the main menu.

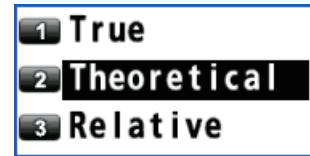

3.1.3 How to use the "cm/sec" display

You can change the unit for the own ship's speed to "cm/sec" from the unit set in subsection 8.3.3.

1. Press the **MENU ESC** key to open the main menu.
2. Select [7 System Setting] then [1 System].
3. Select [2 cm/sec Display].
4. Select [2 On] to use "cm/sec".
5. Press the **MENU ESC** key to close the main menu.
You can also toggle between [cm/sec] and [Preset Unit] (see section 8.3.3) by pressing and holding the **1** key.

3.2 Trip Menu

3.2.1 How to calculate the trip distance

1. Press the **MENU ESC** key to open the main menu.
2. Select [2 Speed/Trip Setting] then [2 Trip].



3. Select [1 Calculation].
4. Select [1 Stop], [2 Start/Restart] or [3 Clear].
 [Stop]: Stops the trip distance calculation.
 [Start/Restart]: Starts or restarts the trip distance calculation.
 [Clear]: Resets the trip distance and trip time.
5. Press the **MENU ESC** key to close the main menu.

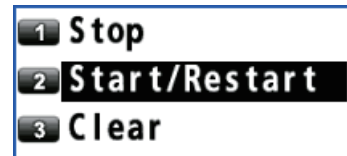

3.2.2 How to set the total distance

1. Press the **MENU ESC** key to open the main menu.
2. Select [2 Speed/Trip Setting] then [3 Total Distance].

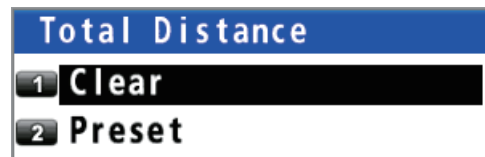

3. Select [2 Preset].
4. Enter the default total distance with the numeric keys.
5. Move the cursor to [Enter] then press the **ENT** key.
6. Press the **MENU ESC** key to close the main menu.

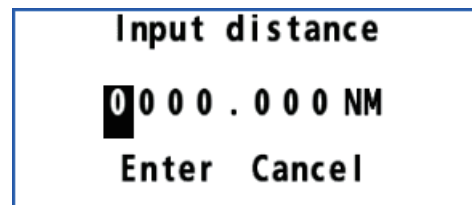

To reset the total distance, select [1 Clear] at step 3. In this case, trip distance and trip time are reset.

3.3 System Menu

3.3.1 How to change the user password

You can set a four-character password to prevent unauthorized entry into certain menus. The default setting is no password.

1. Press the **MENU ESC** key to open the main menu.
2. Select [7 System Setting] then [1 System].
3. Select [9 Password].

Note: The default setting is "0000", which means no password is set. When the password is "0000", the [Input Password] screen does not appear.



4. Enter the password (four characters) with the numeric keys (default: 0000).



5. Enter the new password (four characters) with the numeric keys.



6. Enter the password (four characters) with the numeric keys again.
7. Press the **ENT** key.
8. Press the **MENU ESC** key to close the main menu.

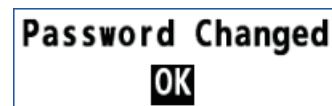

When the password is set, access to the following menus and settings requires password input.

- [4 Maintenance] - [3 Backup] - [2 Load User Setting] (See section 7.7.)
- [6 Sensor Setting] - [9 Device List] - [4 Set Device Instance] (See subsection 3.7.2.)
- [6 Sensor Setting] - [9 Device List] - [5 Set System Instance] (See subsection 3.7.2.)

3.3.2 SNTP setting

SNTP (Simple Network Time Protocol) is a communication protocol that synchronizes the time data in this equipment with UTC.

1. Press the **MENU ESC** key to open the main menu.
2. Select [7 System Setting] then [2 Network].

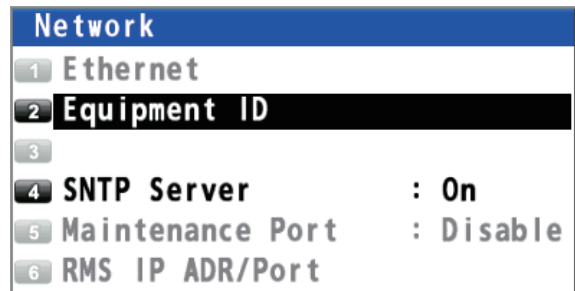

3. Select [4 SNTP Server].
4. Select [1 On], or [2 Off].
5. Press the **MENU ESC** key to close the main menu.



3.4 How to Set the Demo Mode

A demo mode, which shows internally generated navigation data, is provided to acquaint you with the features of the GS-100. You can set the demo mode as follows:

1. Press the **MENU ESC** key to open the main menu.
2. Select [7 System Setting] then [4 Demo].

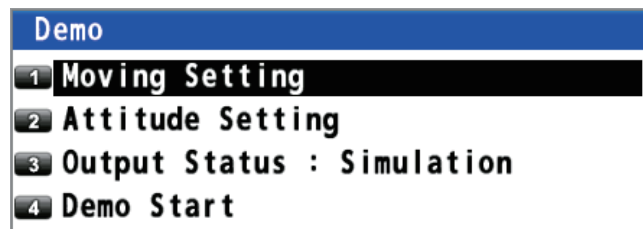

3. Select [1 Moving Setting].

Demo Setting

Date **01/01/2013 00:00**

Position **00°00.0000'N**
000°00.0000'E

Straight

1.Direction **000.0°**

2.SOG **00.0 kn**

Circle

3.Direction **CW CCW**

4.Radius **000.0 NM**

5.Angular Speed **00.0 °/s**

Enter Cancel

3. SETTINGS

4. Enter each setting with the numeric keys referring to the figure above.
 [Date]: Set the starting date and time in UTC.
 [Position]: Set the starting position. To change the coordinate, select "N" or "E" then press one of keys from **0** to **9**.
 [1. Direction]: Set the direction for translatory movement.
 [2. SOG]: Set the speed for translatory movement in kn.
 [3. Direction]: Select the direction for rotary motion from [CW] (clockwise) and [CCW] (counterclockwise).
 [4. Radius]: Set the radius for rotary motion in NM.
 [5. Angular Speed]: Set the angular speed for rotary motion.
5. Move the cursor to [Enter] then press the **ENT** key.
6. Select [2 Attitude Setting].

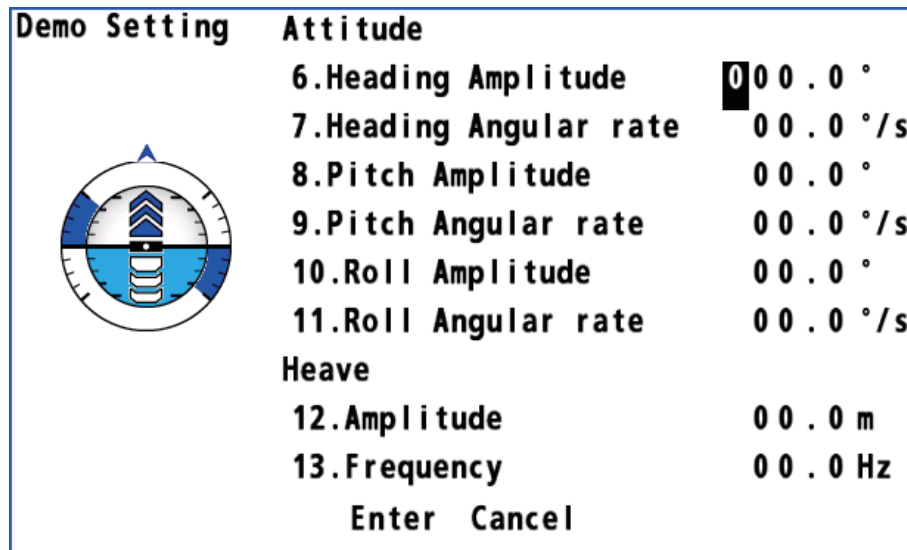

7. Enter each setting with the numeric keys.
 [6. Heading Amplitude]: Set the amplitude for the heading.
 [7. Heading Angular rate]: Set the angular rate for the heading.
 [8. Pitch Amplitude]: Set the amplitude for bow and stern sway of own ship.
 [9. Pitch Angular rate]: Set the angular rate for bow and stern sway of own ship.
 [10. Roll Amplitude]: Set the amplitude for port and starboard sway of own ship.
 [11. Roll Angular rate]: Set the angular rate for port and starboard sway of own ship.
 [12. Amplitude]: Set the amplitude for heave.
 [13. Frequency]: Set the frequency for heave.
8. Move the cursor to [Enter] then press the **ENT** key.
9. Select [3 Output Status].
Note: This function is for a serviceman.
10. Select a mode for NMEA output in demo mode.

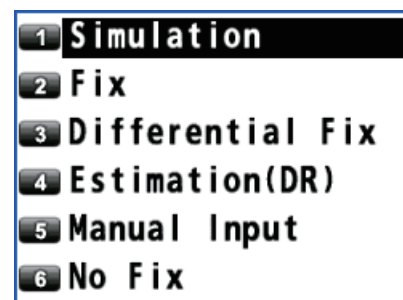

11. Select [4 Demo Start]. The confirmation message appears.
12. Select [1 Yes]. The equipment restarts.



3.5 GNSS Menu

3.5.1 How to set the positioning condition

Satellite elevation

Note: This function is for a serviceman.

You can set the minimum elevation of satellites to use to calculate the heading and position.

Disable satellite

Every GNSS satellite is broadcasting abnormal satellite number(s) in its Almanac, which contains general orbital data about all GNSS satellites. Using this information, the GNSS receiver automatically eliminates any malfunctioning satellite from the GNSS satellite schedule. However, the Almanac sometimes may not contain this information. You can disable an inoperative satellite manually. Enter satellite numbers (up to three satellites) in three digits.

1. Press the **MENU ESC** key to open the main menu.
2. Select [6 Sensor Setting] then [2 GNSS].
3. Select [2 Condition].

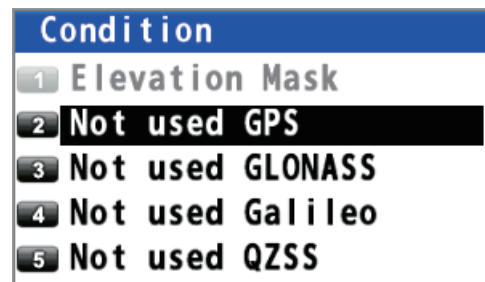

4. Select [2 Not used GPS], [3 Not used GLONASS], [4 Not used GALILEO] or [5 Not used QZSS].
5. Enter the satellite numbers with the numeric keys according to the following setting ranges.
 GPS: 001 to 032
 GLONASS: 001 to 024
 Galileo: 001 to 036
 QZSS: 193 to 197

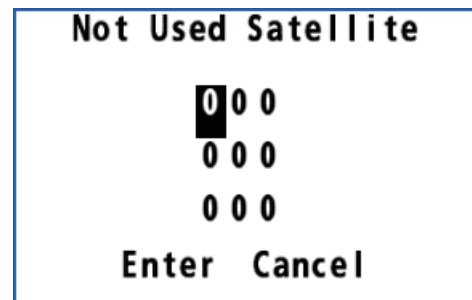

6. Move the cursor to [Enter] then press the **ENT** key.
7. Press the **MENU ESC** key to close the main menu.

3.6 Other Setting Menus for Antenna Unit

3.6.1 How to reset the sensor

You can reset the sensor (antenna unit) when experiencing antenna trouble.

1. Press the **MENU ESC** key to open the main menu.
2. Select [6 Sensor Setting] then [4 Other].

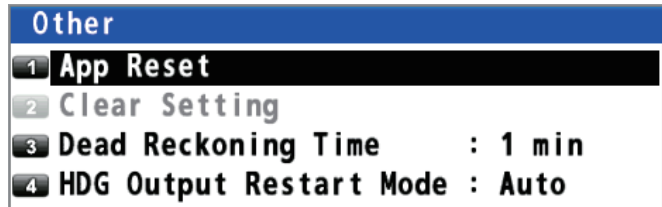

3. Select [1 App Reset].
The confirmation message appears.
4. Select [1 Yes]. The sensor restarts.



3.6.2 How to clear the sensor settings

Note: This function is for a serviceman.

You can clear the sensor (antenna sensor) settings when experiencing antenna trouble.

1. Press the **MENU ESC** key to open the main menu.
2. Select [6 Sensor Setting] then [4 Other].
3. Select [2 Clear Setting]. The confirmation message appears.
4. Select [1 Yes]. The message "Processing..." appears on the screen then the sensor settings are cleared.
5. Turn the power off then on.

3.6.3 How to set the time for dead reckoning

You can set the dead reckoning interval to use with the internal rate gyro sensor to calculate bearing when the GNSS signal is lost.

1. Press the **MENU ESC** key to open the main menu.
2. Select [6 Sensor Setting] then [4 Other].
3. Select [3 Dead Reckoning Time].
4. Select [1 1 min], [2 2 min], [3 3 min], [4 4 min] or [5 5 min].
5. Press the **MENU ESC** key to close the main menu.

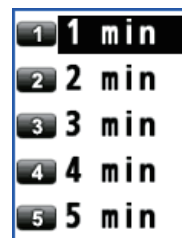

3.7.2 Device menu

The Device List has the [Device] menu, which provides various information about the device selected and sets device instance and system instance. To display the [Device] menu, use the cursorpad to select the device then press the **ENT** key.

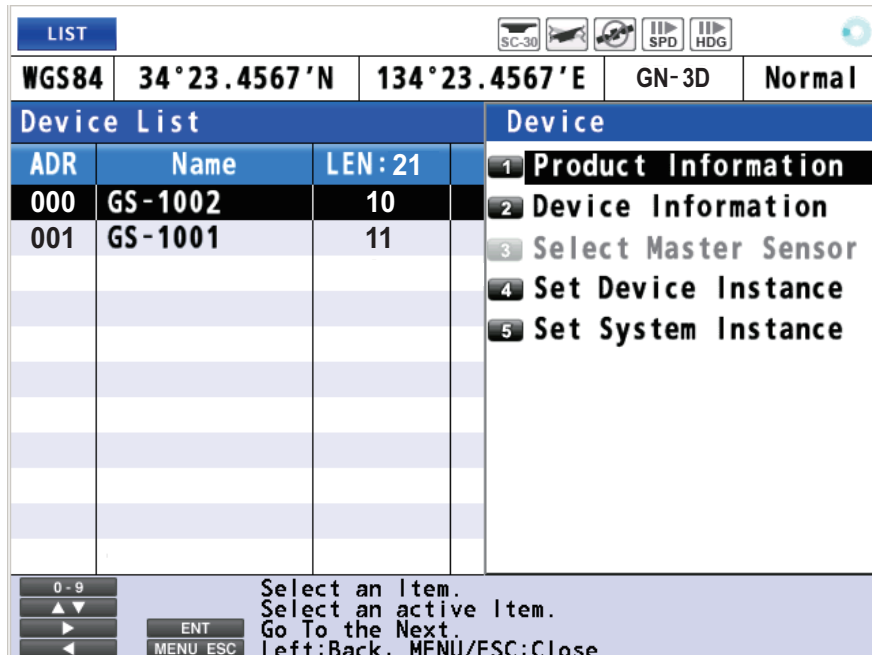

Menu item	Function																		
[1 Product Information]	Displays the product information for the selected device. <table border="1" style="margin-left: 20px;"> <thead> <tr> <th colspan="2">Product Information</th> </tr> </thead> <tbody> <tr> <td>1 Database Ver.</td> <td>1.20</td> </tr> <tr> <td>2 Product Code</td> <td>1855</td> </tr> <tr> <td>3 Model ID</td> <td>GS-1001</td> </tr> <tr> <td>4 Prog. Ver.</td> <td>205xxxx-01.01</td> </tr> <tr> <td>5 Model Ver.</td> <td>1.00</td> </tr> <tr> <td>6 Serial No.</td> <td>-</td> </tr> <tr> <td>7 Certification</td> <td>B+</td> </tr> <tr> <td>8 LEN</td> <td>8</td> </tr> </tbody> </table>	Product Information		1 Database Ver.	1.20	2 Product Code	1855	3 Model ID	GS-1001	4 Prog. Ver.	205xxxx-01.01	5 Model Ver.	1.00	6 Serial No.	-	7 Certification	B+	8 LEN	8
Product Information																			
1 Database Ver.	1.20																		
2 Product Code	1855																		
3 Model ID	GS-1001																		
4 Prog. Ver.	205xxxx-01.01																		
5 Model Ver.	1.00																		
6 Serial No.	-																		
7 Certification	B+																		
8 LEN	8																		
[2 Device Information]	Displays the device information for the selected device. <table border="1" style="margin-left: 20px;"> <thead> <tr> <th colspan="2">Device Information</th> </tr> </thead> <tbody> <tr> <td>1 Industry Group</td> <td>4</td> </tr> <tr> <td>2 Device Class Instance</td> <td>0</td> </tr> <tr> <td>3 Device Class</td> <td>60</td> </tr> <tr> <td>4 Function</td> <td>155</td> </tr> <tr> <td>5 Function Instance</td> <td>0</td> </tr> <tr> <td>6 Device Instance</td> <td>0</td> </tr> <tr> <td>7 Manufacturer Code</td> <td>1855</td> </tr> <tr> <td>8 Unique ID</td> <td>25</td> </tr> </tbody> </table>	Device Information		1 Industry Group	4	2 Device Class Instance	0	3 Device Class	60	4 Function	155	5 Function Instance	0	6 Device Instance	0	7 Manufacturer Code	1855	8 Unique ID	25
Device Information																			
1 Industry Group	4																		
2 Device Class Instance	0																		
3 Device Class	60																		
4 Function	155																		
5 Function Instance	0																		
6 Device Instance	0																		
7 Manufacturer Code	1855																		
8 Unique ID	25																		
[3 Select Master Sensor]	These menus are reserved for future use.																		
[4 Set Device Instance]*																			
[5 Set System Instance]*																			

*: These menu items require the password (see subsection 3.3.1).

3.8 I/O Menu

Besides its fundamental function of displaying position, the GS-100 can also output various data to external equipment. Before outputting data to external equipment, first determine what data the external equipment requires. Output only necessary data to ensure data will be output correctly.

All data transmitted by marine electronics equipment are prefixed with a two character code called a talker. The same talker must be shared by the transmitting and receiving equipment to transmit and receive data successfully.

3.8.1 How to set the output data 1, 2, 3 or 4

1. Press the **MENU ESC** key to open the main menu.
2. Select [5 I/O].

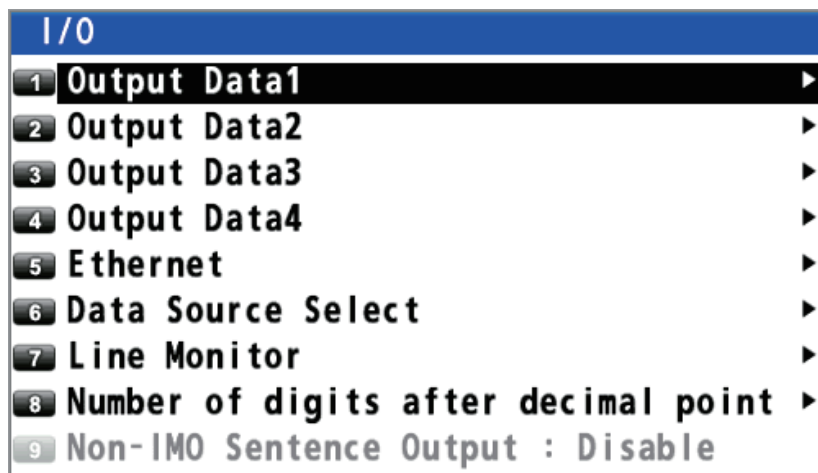

3. Select [1 Output Data1].



4. Select [1 Format].
Note: This function is for a serviceman.
5. Select [1 IEC61162-1 Ed.4], [2 IEC61162-1 Ed.3], [3 NMEA V2.0], [4 NMEA V1.5] or [5 IEC61162-1 Ed.5].

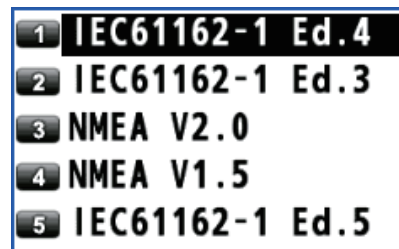

6. Select [2 BPS].
Note: This function is for a serviceman.
7. Select [1 4800 bps] or [2 38400 bps].



3. SETTINGS

8. Select [3 Sentence].

Note: Ask a serviceman, if [GGA], [GLL], [GNS], [RMC] or [XDR] is grayed out as shown in the below example.

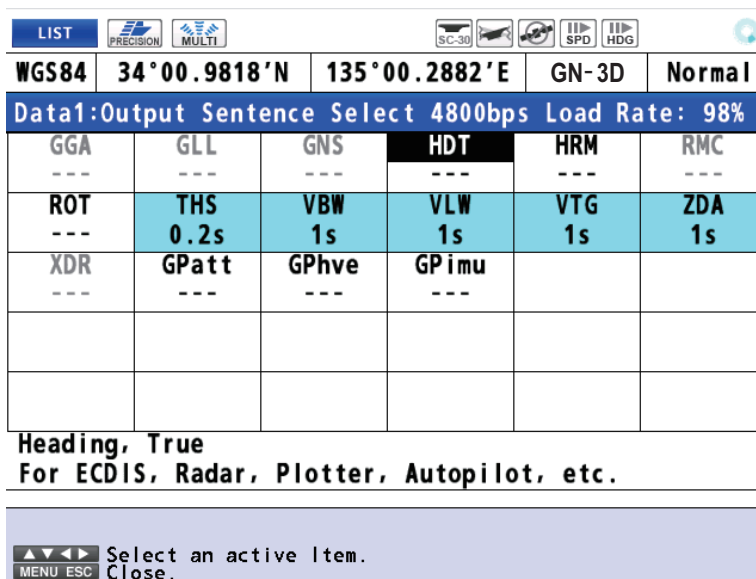

9. Press the cursorpad to select the sentence then press the **ENT** key.
10. Press the cursorpad (◀ or ▶) to select the TX interval.

Sentence	Available TX interval
GGA, GLL, GNS, RMC, VBW, VLW, VTG, XDR, ZDA	[- - -] (off), [1s], [2s], [3s], [4s], [5s], [10s]
HDT, HRM, ROT, THS, GPatt, GPhve, GPimu	[- - -] (off), [0.020s]*, [0.025s]*, [0.1s]*, [0.2s], [1s], [2s], [4s] *: Available when selecting [38400 bps] at step 7.

11. Press the **ENT** key.
12. Set [2 Output Data2], [3 Output Data3] and [4 Output Data4] similarly.
13. Press the **MENU ESC** key to close the sentence window.

3.8.2 How to set the sentences to output to the Ethernet

Note: The SFI settings should be done at installation by a service technician. The SFI must be in the format “ccxxxx” (six characters), where “cc” is the talker (default for this equipment is “VD”). The “xxxx” portion of the SFI has a setting range of 0001 to 9998. To change these settings, consult your installation technician or your local FURUNO dealer.

1. Press the **MENU ESC** key to open the main menu.
2. Select [5 I/O] then [5 Ethernet].
3. Select [1 Sentence].
4. Press the cursorpad to select the sentence then press the **ENT** key.



- Press the cursorpad (◀ or ▶) to select the TX interval.

Sentence	Available TX interval
GGA, GLL, GNS, RMC, VBW, VLW, VTG, XDR, ZDA	[- - -] (off), [1s], [2s], [3s], [4s], [5s], [10s]
HDT, HRM, ROT, THS, GPatt, GPhve, GPimu	[- - -] (off), [0.020s], [0.025s], [0.1s], [0.2s], [1s], [2s], [4s]

- Press the **ENT** key.
- Press the **MENU ESC** key to close the sentence window.

3.8.3 How to select the input data

- Press the **MENU ESC** key to open the main menu.
- Select [5 I/O] then [6 Data Source Select].

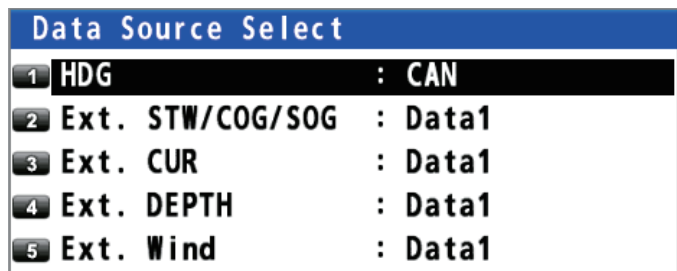

- Select [1 HDG].

- Select the port for heading data.

[1 Data1], [2 Data2], [4 Data4]: Use the heading data received from the equipment connected to the port 1 (or 2, 4). The heading data calculated from the GS-1001 is not used. Go to step 7.

[5 Ethernet]: Use the heading data received from the equipment connected via the LAN port. Go to step 5.

[6 CAN]: Use the heading data calculated from the GS-1001. The heading data received from the external equipment is not used. Go to step 11.

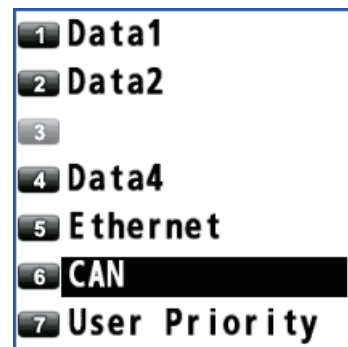

- Enter the Ethernet SFI with two alphabets and four figures. SFI (System Function ID) is an identification code used by the system.

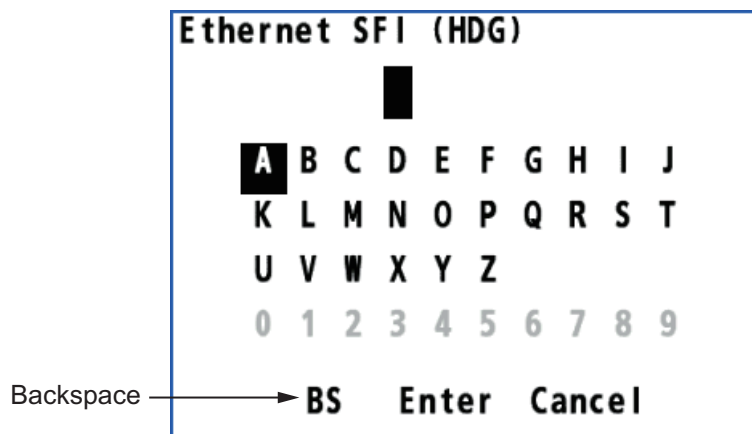

To enter "AB1234", for example, do as follows:

- Use the cursorpad to select "A" then press the **ENT** key.

3. SETTINGS

- 2) Use the cursorpad to select "B" then press the **ENT** key. The cursor moves to "0".
- 3) Use the cursorpad (▶) to select "1" then press the **ENT** key. Or press the **1** key.
- 4) Refer to step 3, enter "2", "3" and "4".
6. Move the cursor to [Enter] then press the **ENT** key. Go to step 11.
7. Select [1 HDG].
8. Select [7 User Priority].

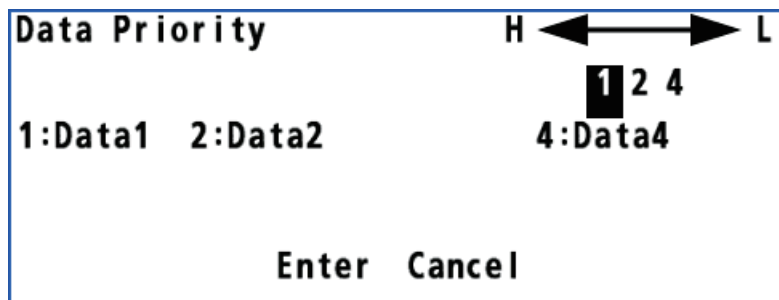

Note 1: The default priority order is Data1 > Data2 > Data4. Data 3 port is not available for serial input.

Note 2: When the heading data is input from CAN, CAN has the top priority.

9. Enter the priority for heading data by port number. For example, to set the priority order as Data1, Data4, Data2, enter 1, 4, 2.

Note: The heading data calculated from the GS-1001 (CAN) has the top priority. Then the heading data set above is used in order.

10. Move the cursor to [Enter] then press the **ENT** key.
11. Set the input data for [2 Ext. STW/COG/SOG] (external speed through water/course over ground/speed over ground), [3 Ext. CUR] (external current), [4 Ext. DEPTH] (external water depth) and [5 Ext. Wind] (external true wind speed and angle) as well. Set these menus when the external input is available.
Note: [CAN] is available only for [HDG].
12. Press the **MENU ESC** key to close the main menu.

3.8.4 Line monitor log

Line monitor

1. Press the **MENU ESC** key to open the main menu.
2. Select [5 I/O] then [7 Line Monitor].

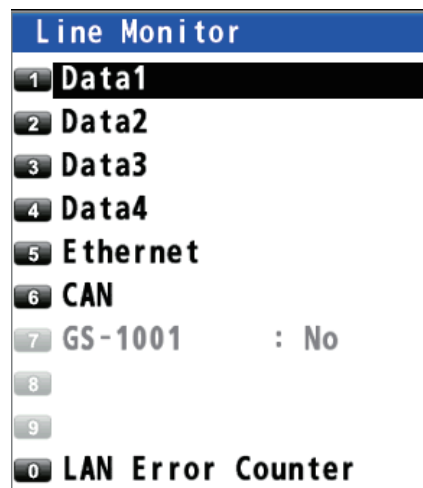

- Select [1 Data1] (or 2, 3, 4), [5 Ethernet] or [6 CAN]. The following is an example of the display for [Data1].

LIST				
WGS84	34°25.4201'N	134°18.6884'E	GN-3D	Normal
Serial Data1: 4800 bps			No USB	
Rx		Tx		
\$YCMTW,027.32,C\$GPZDA,012614.00,01,11,2012,-09.00 42	\$GPZDA,012613.00,01,11,2012,-09.00 45			
\$YCMTW,027.32,C\$GPZDA,012614.00,01,11,2012,-09.00 42	\$GPDTM,W84,,00.0000,N,00.0000,E,,W84 41			
\$YCMTW,027.32,C\$GPZDA,012614.00,01,11,2012,-09.00 42	\$GPGGA,012614.00,0844.7963,S,11512.6084,E,2,6,0.7,15,M,,M, 78			
\$YCMTW,027.32,C\$GPZDA,012614.00,01,11,2012,-09.00 42	\$GPVTG,258.0,T,256.5,M,0.1,N,0.2,K,D 2E			
\$YCMTW,027.32,C\$GPZDA,012614.00,01,11,2012,-09.00 42	\$GPZDA,012613.00,01,11,2012,-09.00 45			
\$YCMTW,027.32,C\$GPZDA,012614.00,01,11,2012,-09.00 42	\$GPDTM,W84,,00.0000,N,00.0000,E,,W84 41			
\$YCMTW,027.32,C\$GPZDA,012614.00,01,11,2012,-09.00 42	\$GPGGA,012614.00,0844.7963,S,11512.6084,E,2,6,0.7,15,M,,M, 78			
\$YCMTW,027.32,C\$GPZDA,012614.00,01,11,2012,-09.00 42	\$GPVTG,258.0,T,256.5,M,0.1,N,0.2,K,D 2E			
\$YCMTW,027.32,C\$GPZDA,012614.00,01,11,2012,-09.00 42	\$GPZDA,012613.00,01,11,2012,-09.00 45			
\$YCMTW,027.32,C\$GPZDA,012614.00,01,11,2012,-09.00 42	\$GPDTM,W84,,00.0000,N,00.0000,E,,W84 41			
\$YCMTW,027.32,C\$GPZDA,012614.00,01,11,2012,-09.00 42	\$GPGGA,012614.00,0844.7963,S,11512.6084,E,2,6,0.7,15,M,,M, 78			
\$YCMTW,027.32,C\$GPZDA,012614.00,01,11,2012,-09.00 42	\$GPVTG,258.0,T,256.5,M,0.1,N,0.2,K,D 2E			

MENU ESC Close.

- Press the **MENU ESC** key to close the line monitor log.

LAN error counter

- Press the **MENU ESC** key to open the main menu.
- Select [5 I/O] then [7 Line Monitor].
- Select [0 LAN Error Counter].

LIST				
WGS84	34°31.3041'N	134°22.8059'E	GN-3D	Normal
Ethernet Error Counter				
Ethernet Error				Count
1	Incorrect Sentence			000
2	TAG Block Framing Error			000
3	TAG Syntax Error			000
4	TAG Block Checksum Error			000
5	Incorrect TAG Block			000
6	Invalid Header			000
7	UDP Checksum Error			000

MENU ESC Close.

Press the **ACK** key to reset all counts to 0.

- Press the **MENU ESC** key to close the LAN error counter.

3.8.5 How to set the digit number for sentences

Set the number of figures to show after the decimal point for heading, speed (VTG, VBW), and roll, pitch.

1. Press the **MENU ESC** key to open the main menu.
2. Select [5 I/O] then [8 Number of digits after decimal point].

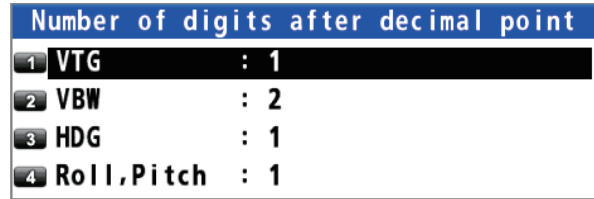

3. Select [1 VTG], [2 VBW], [3 HDG] or [4 Roll, Pitch].
4. Select [1 1] or [2 2].

[1]: Displays the sentence data to the first decimal place.

[2]: Displays the sentence data to the second decimal place.

Note 1: When changing the setting for [3 HDG], the setting is reflected to the ROT indication.

Note 2: When changing the setting for [4 Roll, Pitch], the setting is reflected to the HEAVE indication.



5. Press the **MENU ESC** key to close the main menu.

3.9 How to Clear the Memory

You can clear display setting or GNSS memory to start afresh, or restore the default settings.

1. Press the **MENU ESC** key to open the main menu.
2. Select [7 System Setting] then [9 Clear Memory].
3. Select [1 Clear Display Setting], [2 Clear GNSS] or [3 Clear All].

[Clear Display Setting]: Clears the display setting.

[Clear GNSS]: Clears the GNSS memory.

[Clear All]*: Clears both display setting and GNSS memory.

*: For [Clear All], the window for password appears. Enter the password (four characters) with the numeric keys.

A confirmation message appears. Select [Yes] to continue, or [No] to cancel.

[Clear Ethernet Setting]: Clears the IEC61162-450 network settings and restores the default settings (listed below).

- IP Address: 192.168.0.1
- Subnet Mask: 255.255.255.0
- Default Gateway: 0.0.0.0

[Factory Default]: Restores the unit to factory default settings.

4. Select [1 Yes]. The message "Processing..." appears. After the memory clear, the application automatically restarts.

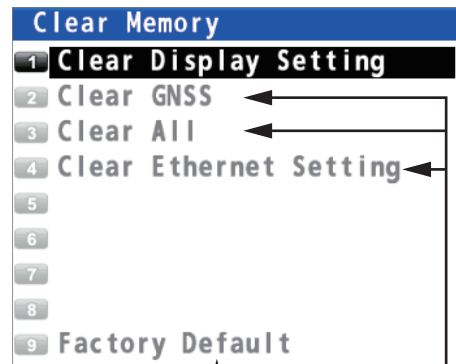

For serviceman

4. NOTICES

There are two notice conditions which generate both audio and visual notices: Ship Speed and Trip. When the conditions of a notice are met, the buzzer sounds according to the notice sound setting and the icon related to the notice turns from gray to blue at the top right-hand corner of the display.

You can silence the buzzer by pressing the **ACK** key.

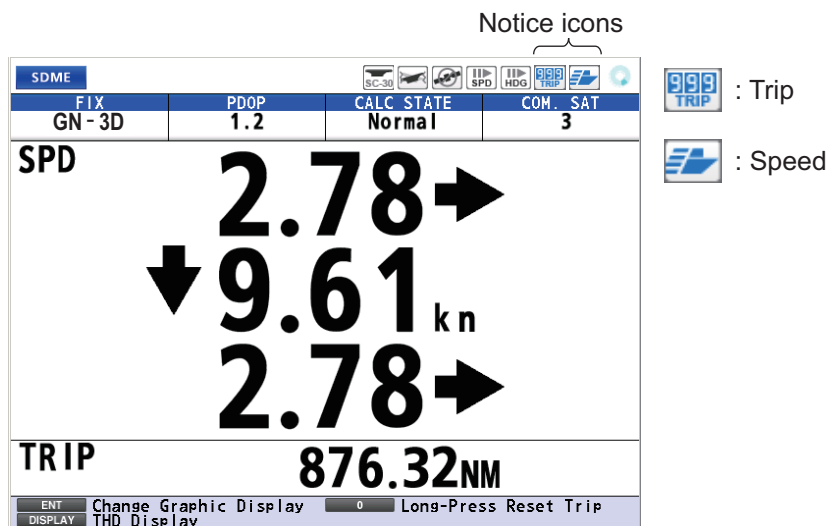

4.1 Audio Notice Type

You can select the audio notice type as follows. When the conditions of a notice are met, the icon color related to the notice changes regardless of the audio notice type.

1. Press the **MENU ESC** key to open the main menu.
2. Select [2 Speed/Trip Setting] then [4 Sound].

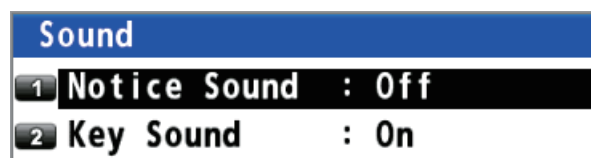

3. Select [1 Notice Sound].
4. Select [1 Off], [2 On] or [3 Continuous].
[Off]: No sound, only visible notice (an icon turns blue)
[On]: Three long buzzer and visible notice (an icon turns blue)
[Continuous]: This buzzer sounds until the **ACK** key is pressed (to acknowledge the notice). Visible notice (an icon turns blue).
5. Press the **MENU ESC** key to close the main menu.

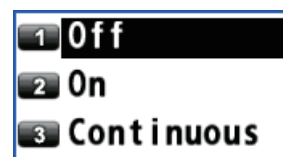

4.2 Ship Speed Notice

The ship speed notice alerts you when own ship's speed is lower or higher than the speed setting or within the range set.

1. Press the **MENU ESC** key to open the main menu.

4. NOTICES

2. Select [2 Speed/Trip Setting] then [1 Ship Speed].
 3. Select [2 In] or [3 Out]. The ship speed notice icon () appears in gray at the top right-hand corner of the display.
[In]: The notice alerts you when own ship's speed is within the range set.
[Out]: The notice alerts you when own ship's speed is lower or higher than the range set.
 4. Select [1 Ship Speed].
 5. Select [4 Speed].
 6. Enter the minimum and maximum speeds with the numeric keys.
Note: When the settings for minimum and maximum are equal, the notice alerts you when own ship's speed matches the setting, or is higher than the setting for [2 In] or lower for [3 Out].
 7. Move the cursor to [Enter] then press the **ENT** key.
 8. Press the **MENU ESC** key to close the main menu.
- To turn off the ship speed notice, select [1 Off] at step 3.

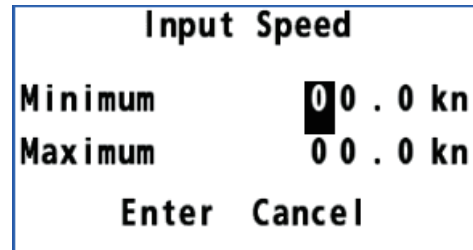
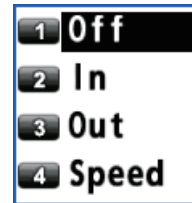

4.3 Trip Notice

The trip notice alerts you when own ship has traveled the preset trip distance.

1. Press the **MENU ESC** key to open the main menu.
 2. Select [2 Speed/Trip Setting] then [2 Trip].
 3. Select [2 Range].
 4. Enter the trip distance with the numeric keys.
 5. Move the cursor to [Enter] then press the **ENT** key.
 6. Select [3 Notice].
 7. Select [2 On] to turn on the trip notice. The trip notice icon () appears in gray at the top right-hand corner of the display.
 8. Select [1 Calculation].
 9. Select [2 Start/Restart]. The system starts the trip calculation.
 10. Press the **MENU ESC** key to close the main menu.
- To turn off the trip notice, select [1 Off] at step 7.

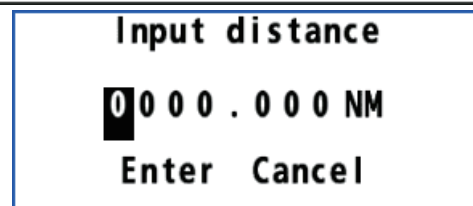
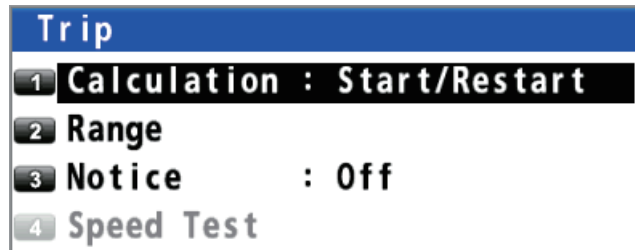

5. ALERTS

5.1 Overview

5.1.1 What is an Alert?

"Alert" is a generic name for a notice to any unusual or potentially dangerous situation generated within the system.

Alerts are classified according to priority and category.

Alert priority

There are three alert priorities: alarm, warning and caution. This equipment uses warning and caution priority alerts and does not use alarms. The definitions for warning and caution priorities is outlined below.

Warning: Conditions or situations which require immediate attention for precautionary reasons, to make the bridge team aware of conditions which are not immediately hazardous, but may become so.

Caution: Awareness of a condition which continues to require attention out of the ordinary consideration of the situation or of given information.

Alert category

An alert is further classified by category, A, B or C, according to its degree of severity or source.

Category	Description
A	Category A alerts include the following, and must be confirmed from the equipment that generated the alert. <ul style="list-style-type: none">• Danger of collision• Danger of grounding
B	Category B alerts are alerts where no additional information for decision support is necessary. Category B alerts are all alerts not falling under category A.
C	IAS (Integrated Automation System) generated engine alert

When a warning level alert occurs, the buzzer sounds and the name of the alert appears at the bottom of the display in yellow-orange color, along with the alert number and instance.

When a caution level alert occurs there is no buzzer sound, however the alert name and number appear at the bottom of the display in yellow color.

When more than one alert is active, the highest priority alert appears in the flashing indication. Other active alerts, referred to as "background alerts", are indicated with an icon, located to the right edge of the flashing indication. Background warning icons flash (their color is reversed) until acknowledged. Background cautions icons are displayed steadily.

5. ALERTS

Example alert message (flashing)



These icons only appear when multiple alerts of the related level are active. The icon also shows the alert level: "W" for Warnings and "C" for Cautions.

The GS-100 tracks active (acknowledged but not rectified, or unacknowledged) alerts in the [ALERT LIST]. Alerts which are acknowledged and rectified are saved in the [ALERT LOG].

For a full list of possible alerts, along with their details such as alert codes and remedies or action required, see "ALERT LIST" on page AP-26.

Alert icons

This equipment uses alert icons to indicate the alert level and status. For a list of the possible icons, see "Symbols" on page AP-9.

The GS-100 release alerts according to the alert mode selected at installation (Alert I/ F1, Alert I/F2, Legacy; see section 8.3.8). For full lists of the alerts for each alert mode, see "ALERT LIST" on page AP-26.

When an alert situation occurs, the buzzer sounds (except for a caution) and the name of the alert appears at the bottom of the display. Also, the values and indication for the following items are displayed in yellowish orange for a warning, yellow for a caution.

- 3-axis speed
- Calculation state (DR, Stopped, SYS FAULT)
- Time and date (only when the status indication is "No Fix")
- Heading
- Position (only when the status indication is "No Fix")

In addition to the alert appeared at the bottom of the display, there is any alert, the appropriate icon appears in the bottom-right corner of the display in the following situations:

- There is an additional active alert.
- There is an additional rectified unacknowledged alert.

The icons which may appear are for warning level alerts and for caution level alerts.



Background alert icon(s) appear(s) here.

Note: When a warning is not acknowledged within five minutes, the warning is repeated.

5.2 Alert List

The alert list shows all currently violated alerts and state of acknowledgment. All unacknowledged alerts are shown, even those whose reason for the alert has passed.

Note: When there are no active alerts, the message "No Active Alerts" appears in the title bar (blue section).

1. Press the **MENU ESC** key to open the main menu.
2. Select [3 Alert] then [1 Active Alert] to show the alert list. Unacknowledged alerts flash.

Not acknowledged

Alert number — Alert title

Alert icon —

Date and time of occurrence — Position of occurrence

Acknowledged

Alert icon	Alert number	Alert title	Date and time of occurrence	Position of occurrence
!	3062-5	System Fault	07:58 03/Mar/2021	35° 28.5055'N 136° 30.4130'E

The Alert list can also be shown by operating the **LIST** key (see section 1.5).

3. Press the **MENU ESC** key to close the alert list.

5.3 Alert Log

The alert log shows the latest 50 alerts. When the log becomes full, the oldest entry is erased to make room for current alerts.

1. Press the **MENU ESC** key to open the main menu.
2. Select [3 Alert] then [4 Alert Log] to show the alert log.

The screenshot shows the alert log interface with the following data:

Alert number	Priority	Alert name	Date and time of occurrence	Date and time of acknowledgement	Position of occurrence
01	Caution	430306 Too few Common Satellites	04:43 29/May/2018 34° 21.7139'N 134° 21.6821'E	ACK : --:-- --/---/----	RECT: 04:43 29/May/2018
02	Caution	430306 Too few Common Satellites	04:43 29/May/2018 34° 21.7139'N 134° 21.6821'E	ACK : :--:-- :--/---/----	RECT: : 04:43 29/May/2018
03	Warning	3062 Too few Common Satellites	04:42 29/May/2018 34° 21.7139'N 134° 21.6821'E	ACK : 04:43 29/May/2018	RECT: 04:43 29/May/2018

Annotations in the diagram point to the following fields:

- Alert number (03)
- Priority (Warning)
- Alert name (3062 Too few Common Satellites)
- Date and time of occurrence (04:42 29/May/2018 34° 21.7139'N 134° 21.6821'E)
- Date and time of acknowledgement (ACK : 04:43 29/May/2018)
- Date and time when alert was rectified (RECT: 04:43 29/May/2018)
- Position of occurrence (34° 21.7139'N 134° 21.6821'E)

3. Press the **MENU ESC** key to close the alert log.

5.4 How to Acknowledge Alerts

With the ACK key

When an alert condition occurs, the buzzer sounds (warning alert only) and the alert type indication appears at the bottom of the display. Press the **ACK** key to acknowledge the alert. The buzzer stops and the alert type indication disappears. If multiple alert conditions occur simultaneously, the alerts are acknowledged in order of importance.

How to acknowledge an alert from the alert list

1. Open the alert list (see section 5.2).
2. Press the cursorpad (**▲** or **▼**) to select the alert to acknowledge then press the **ENT** key.

5.5 Responsibility Transfer Alert

MSC302(87) requires the use of the “responsibility transfer alert,” which functions in the multiple sensor, multiple equipment installation. When one sensor or one equipment fails but does not disturb the system operation (other sensor or equipment is normal), the CAM automatically sends the “responsibility transfer alert” (ACN sentence) to the sensor or equipment that generated the alert.

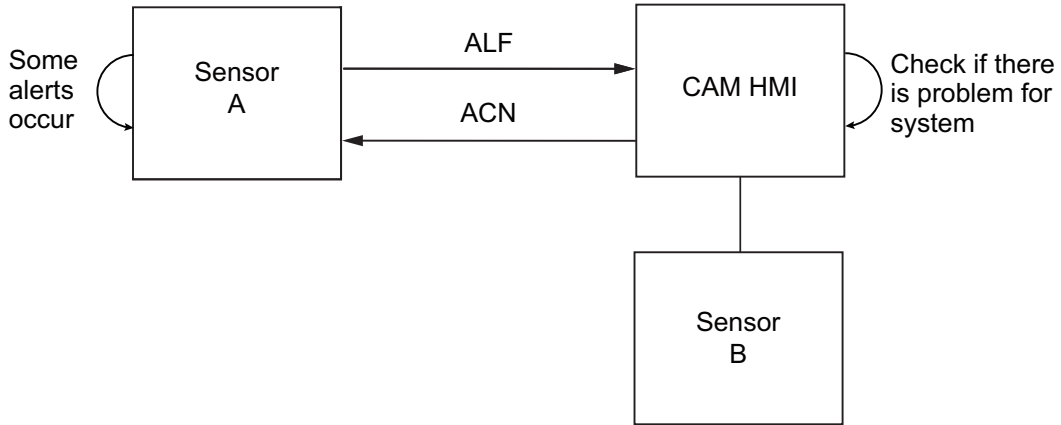

If the sensor or equipment refuses the responsibility transfer, normal operation is restored.

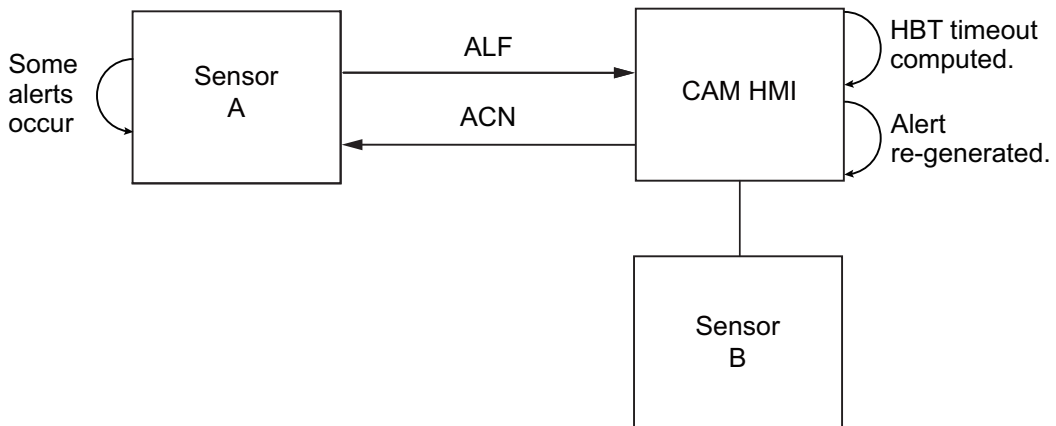

If the HBT sentence is not received from equipment within the prescribed time interval, the alert processed as responsibility transfer alert is made active and the “System communication fail” alert is generated.

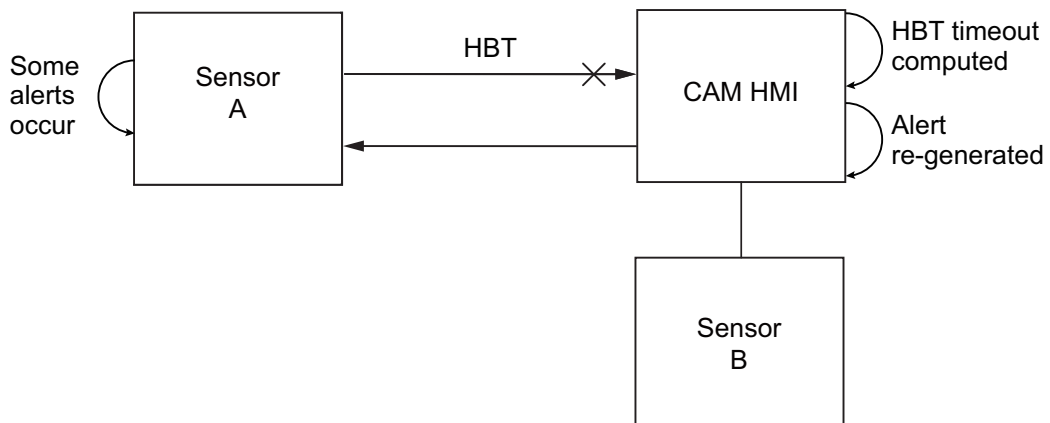

5. ALERTS

This page is intentionally left blank.

6. BERTHING DISPLAY

The berthing display shows ship's track (past and/or predicted) and provides help with berthing operations. With position and heading inputs, customizable berthing lines can be shown to help in berthing.

All berthing lines within the current display range are automatically shown.

The display orientation is available in Head-up and North-up. Head-up has your heading at the screen top and North-up has North at the top.

The navigation data, which appears at the left side of the display, can be shown or hidden as necessary.

The 3-axis speed display shows ship's speed in three axes: transverse speed at the reference point, longitudinal speed, and transverse speed at the reference point.

6.1 Berthing Display for the GS-100

On the berthing display from the GS-100, the following four data are displayed as "-- --" because they are not input.

- Doppler sonar SOG (STW) and COG
- Current (tide) speed and direction
- Wind reference, speed and angle
- Depth

Long-push the **ENT** key of the DS-600 to show the display for 3-axis speed data as below (see section 6.6).

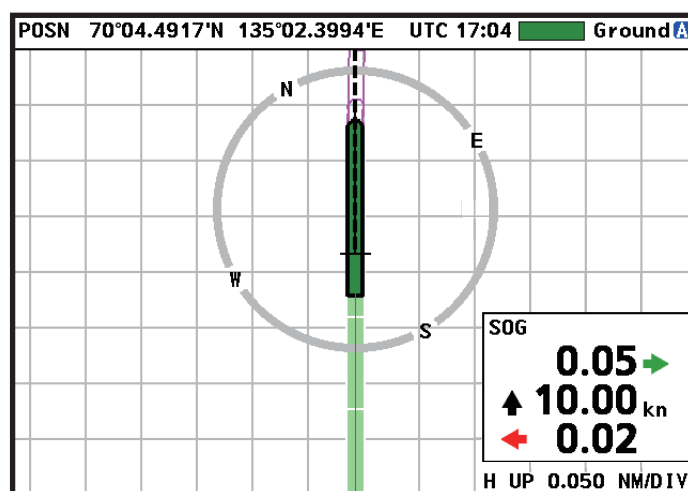

3-axis speed data, NAV data OFF

You can prepare and edit berthing lines on the display unit GS-1002 and send them to the optional display unit DS-600 for display on the unit. For installation details, see section 8.5.

6. BERTHING DISPLAY

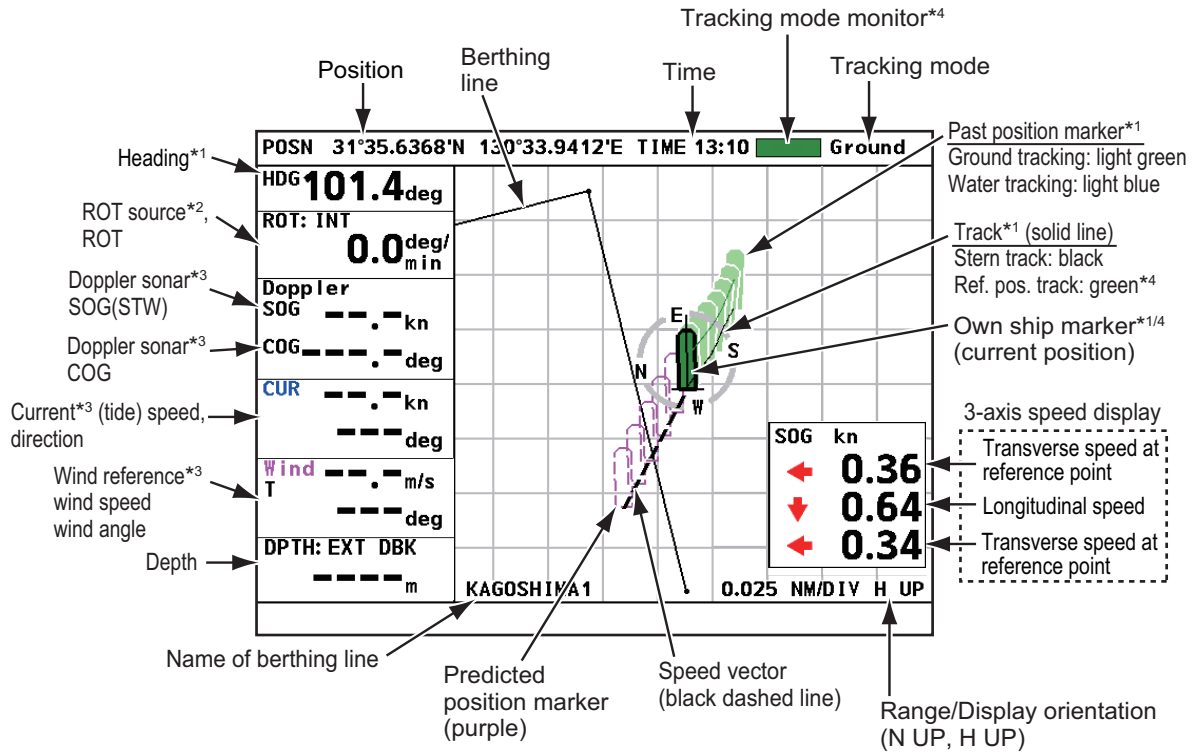

- *1: Requires heading data. If there is no heading data, "--" appears and the ▲ mark and "NSEW" (indicates the azimuth) are not shown.
- *2: ROT: Heading data is required only for [EXT HDG].
- *3: These data can not be displayed in the GS-100.
- *4: Ground tracking: Green, Water tracking: Blue

3-axis speed data and NAV data

Own ship marker

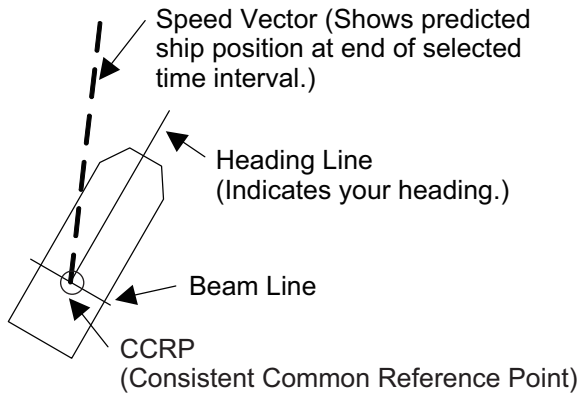

The own ship marker indicates current position. The marker is green for ground tracking and blue for water tracking. The marker is scaled according to ship length and width, set on the [ShipSize•ANT/CALC-SPD POS] menu (see "Ship size and antenna position" in paragraph 8.4.7)*. If the range and dimensions of the ship are as shown below, the marker is shown with concentric circles.
 Range x 8 ≥ Ship's length x 30, or Width x 52

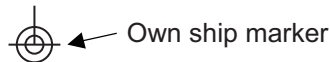

*: [GGA], [HDT] and [ROT] must be selected on the [I/O] - [Output Data1] - [Sentence] menus (see paragraph 3.9.1).

6.2 Controls for the Display Unit DS-600

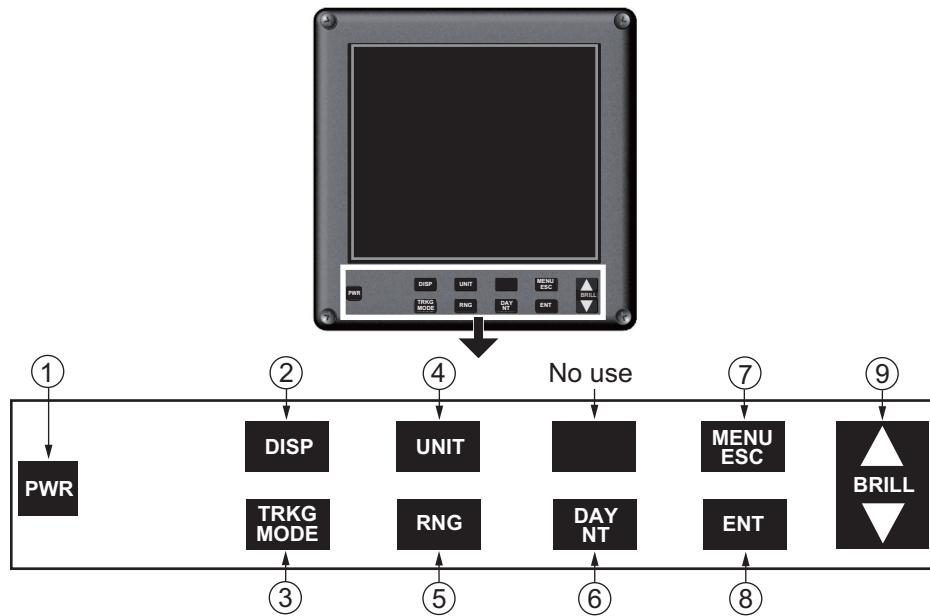

No.	Control	Function
1	PWR	Turn the power on and off.
2	DISP	<ul style="list-style-type: none"> Select a display. Close the menu and return to the last-used display. In multiple data displays, select a data indication to change its unit of measurement (with the UNIT key).
3	TRKG/MODE	Select the ship speed mode between SOG and STW.
4	UNIT	Select the unit of measurement for speed, depth, distance, current (tide) speed, wind speed, etc.
5	RNG	Select the range in the berthing and echo monitor displays.
6	DAY/NT	Select the daytime and nighttime displays alternately.
7	MENU ESC	<ul style="list-style-type: none"> Open the menu. Return control to the menu window without making any changes at the menu options window. Select the item to change its unit of measurement in multiple data displays. Close the menu when the menu window is active.
8	ENT	<ul style="list-style-type: none"> Confirm an operation in menu operation. Long-push to hide or show nav data and 3-axis speed data in the berthing display.
9	BRILL	<ul style="list-style-type: none"> Adjust the screen brilliance in 10 levels including off. ▼ to decrease the brilliance, ▲ to increase the brilliance. To quickly increase or decrease the brilliance, press and hold the related cursorpad point. Move the cursor in menu operation.

6.3 Various Settings

Key beep

A key beeps when it is pressed. You can turn this beep on or off.

1. Press the **MENU ESC** key to open the menu.
2. Select [Key Beep] then press the **ENT** key.
3. Select [ON] or [OFF] then press the **ENT** key.
4. Press the **DISP** key to close the menu.

Select	
ON	
OFF	
[▲]/[▼]	: Select
[ENT]	: Enter
[MENU/ESC]	: Cancel
[DISP]	: Exit

Key dimmer

You can adjust the dimmer for the keys as follows:

1. Press the **MENU ESC** key to open the menu.
2. Select [Key BRILL] then press the **ENT** key.
3. Select a dimmer level (setting range: 1 to 8) then press the **ENT** key. The higher the figure, the higher the dimmer level.
4. Press the **DISP** key to close the menu.

Select	
1	
2	
3	
4	
5	
6	
7	
8	
[▲]/[▼]	: Select
[ENT]	: Enter
[MENU/ESC]	: Cancel
[DISP]	: Exit

How to change units of measurement

The **UNIT** key selects the unit of measurement for current (tide) speed, depth, distance, Doppler SOG and STW, GNSS SOG, and wind speed.

1. Press the **UNIT** key. A unit is highlighted in yellow.
2. Press the **DISP** key to select the data for which to change its unit. (Use the **MENU ESC** key to reverse the selection order.)
3. Press the **UNIT** key to change the unit. See the table below for item and available units.

Item	Available units
Berthing display range	meters/DIV (m/DIV), nautical miles/DIV (NM/DIV)
Ground tracking (SOG) Water tracking (STW)	kilometers/hour (km/h), knots (kn), meters/second (m/s)

To quit the unit selection, press the **DISP** key until the yellow highlight disappears.

How to set time**Time**

You can select the source for time, set local time, and turn summer time indication (daylight savings time) on or off.

1. Press the **MENU ESC** key to open the menu.
2. Select [Ship's Time] then press the **ENT** key.

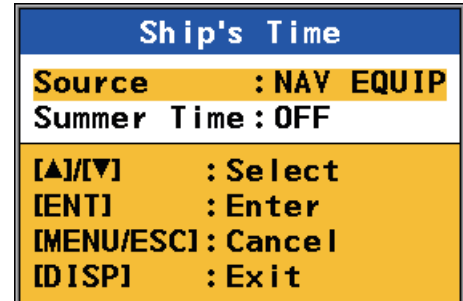

3. Select [Source] then press the **ENT** key.

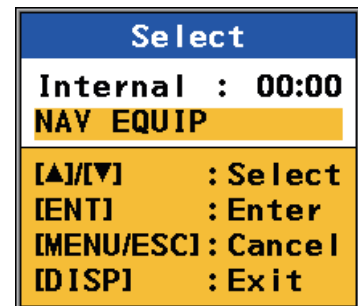

4. Select [Internal] or [NAV EQUIP] then press the **ENT** key. Select [Internal] to use local time, or [NAV EQUIP] to use UTC time. For [Internal], the [Local Time ADJ] screen appears; go to step 5. For [NAV EQUIP], go to step 6.
5. Use ▲ or ▼ to set the time difference between local time and UTC time then press the **ENT** key.



6. Select [Summer Time] (to turn the daylight savings time indication on or off) then press the **ENT** key.
7. Select [ON] or [OFF] then press the **ENT** key.
8. Press the **DISP** key to close the menu.

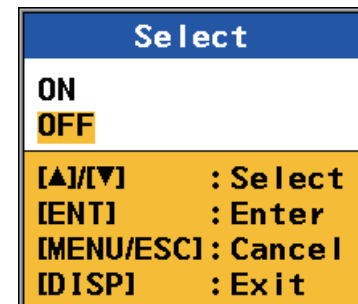

6. BERTHING DISPLAY

Time format

You can display time in UTC or ship's time (local time).

1. Press the **MENU ESC** key to open the menu.
2. Select [Scale Set Up] then press the **ENT** key.
3. Select [Mode] then press the **ENT** key.

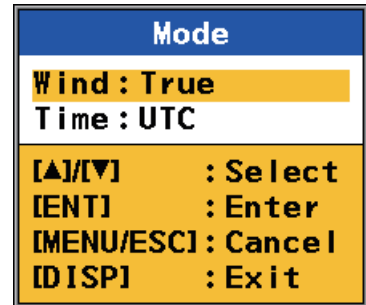

4. Select [Time] then press the **ENT** key.
5. Select [UTC] or [Ship's Time] then press the **ENT** key.
6. Press the **DISP** key to close the menu.

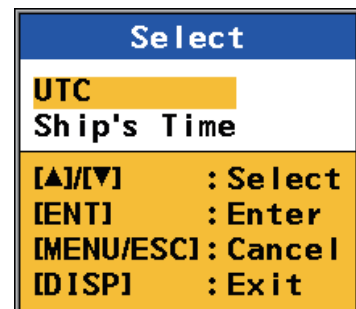



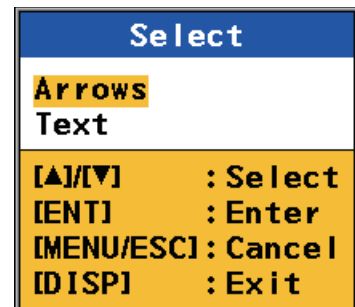

Direction symbol format

The direction symbols for speed and ROT can be shown with arrows or text.

1. Press the **MENU ESC** key to open the menu.
2. Select [Scale Set Up] then press the **ENT** key.
3. Select [Direction SYM] then press the **ENT** key.
4. Select [Arrows] or [Text] then press the **ENT** key.



Arrows	Text
	STBD, S*
	PORT, P*
	FWD
	AFT

* Navigation data display, berthing display

5. Press the **DISP** key to close the menu.

Vector Time

The tip of the vector line on the own ship marker shows the estimated position of your ship after the selected vector time elapses, using the current course and speed. You can adjust the length of the vector line to see estimated position at the end of the selected time interval.

1. Press the **MENU ESC** key to open the menu.
2. Select [Vector Time] then press the **ENT** key.
3. Select a vector time then press the **ENT** key. The longer the time, the longer the vector line.
4. Press the **DISP** key to close the menu.

Select	
30s	
1min	
2min	
5min	
10min	
20min	
[▲]/[▼]	: Select
[ENT]	: Enter
[MENU/ESC]	: Cancel
[DISP]	: Exit

6.4 Display Range

6.4.1 How to select a range

The display range is the distance between grid sides on the berthing display. Use the **RNG** key to select a range. The range appears below the 3-axis speed display as shown below. The system is pre-set with five ranges (nm): 0.025, 0.04, 0.05, 0.075 and 0.1. A total of 11 ranges are available and you can select the ranges to use from the menu, as shown in the next paragraph.

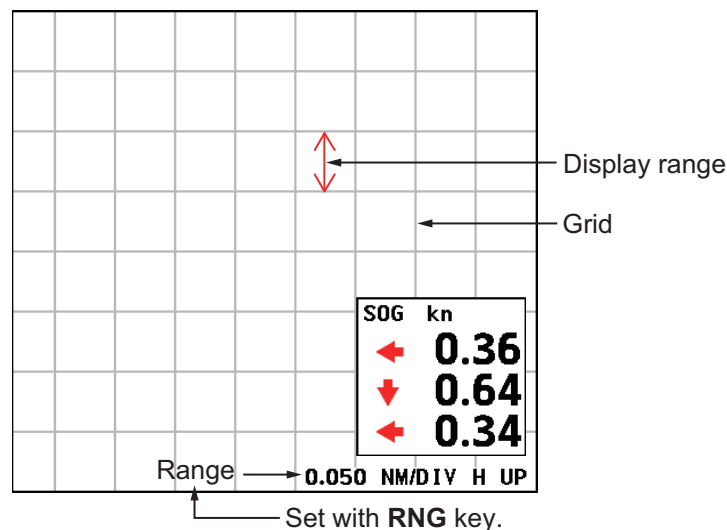

6.4.2 How to pre-set ranges

The berthing display has a total of 11 ranges. Select the ranges to use, following the procedure shown below. A minimum of one range must be turned on.

1. Press the **MENU ESC** key to open the menu.
2. Select [Scale Set Up] then press the **ENT** key.
3. Select [Range] then press the **ENT** key.
4. Select a range then press the **ENT** key. Show "X" in a check box to select the range, or remove the "X" to deselect the range.
5. Press **▼** to show and select [Save] then press the **ENT** key.
Note: If all ranges are turned off, the message "No item be selected." appears. Select at least one range.
6. Press the **DISP** key to close the menu.

Select	
<input checked="" type="checkbox"/>	50m(0.025NM)
<input checked="" type="checkbox"/>	75m(0.040NM)
<input checked="" type="checkbox"/>	100m(0.050NM)
<input checked="" type="checkbox"/>	150m(0.075NM)
<input checked="" type="checkbox"/>	200m(0.100NM)
<input type="checkbox"/>	250m(0.125NM)
<input type="checkbox"/>	300m(0.150NM)
<input type="checkbox"/>	400m(0.200NM)
<input type="checkbox"/>	600m(0.300NM)
<input type="checkbox"/>	800m(0.400NM)
<input type="checkbox"/>	1000m(0.500NM)
[▲]/[▼]	: Select
[ENT]	: Enter
[MENU/ESC]	: Cancel
[DISP]	: Exit

6.5 Track

You can show past track or predicted track, or both past and predicted tracks on the display using the speed data.

6.5.1 Types of tracks

Two types of track are available: past and predicted.

Past track

The past track can be shown with a solid line or both solid line and past ship markers.

Solid line: There are two types of past track: reference position track and stern track. The reference position track is green (ground tracking) or blue (water tracking), and the stern track is black. The tracks of the past five minutes are shown.

Past ship markers: A past track marker is added every 30 seconds. The markers are colored light blue for water tracking, and light green for ground tracking. The last five minutes of past track markers are shown.

You can select the type of past track to show from the menu. See subsection 6.5.3 for the procedure.

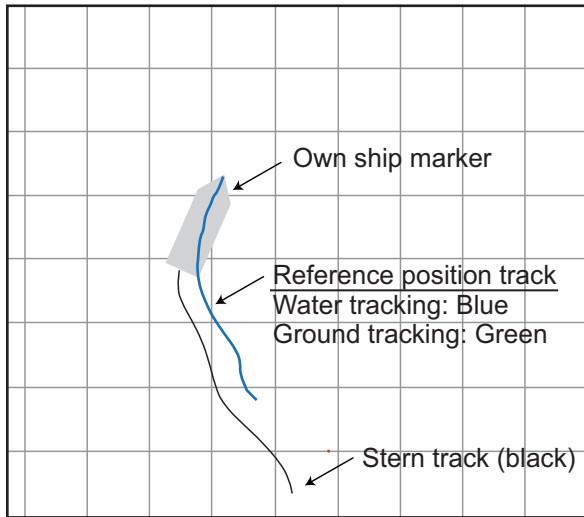

Past track (solid line)

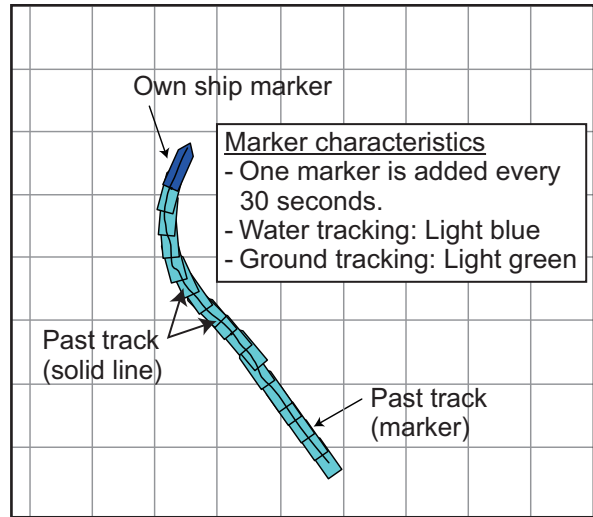

Past track (marker and solid line)

Predicted track

The predicted track feature shows estimated position of your ship at the end of the selected time interval. (See subsection 6.5.4 for the procedure.) The estimated position is calculated from the reference point and stern speeds taken from the ground and water tracking speed data. The marker is purple, hollow and dashed to distinguish it from the own ship marker and the past track markers.

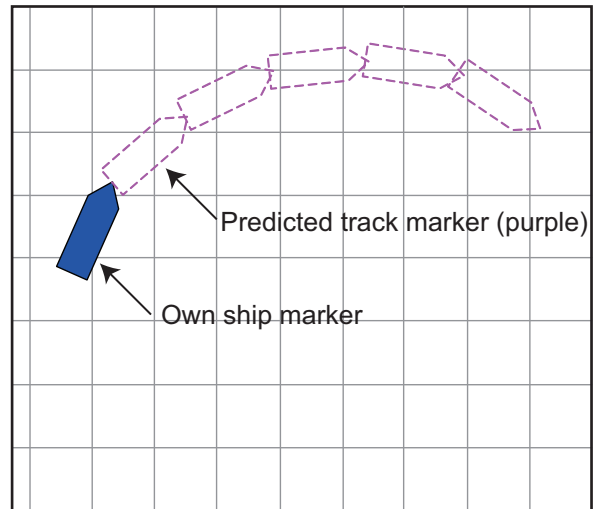

Predicted track

6.5.2 How to select the type of track to display

1. Press the **MENU ESC** key to open the menu.
2. Select [Ship's Track] then press the **ENT** key.
3. Select the type of track to display then press the **ENT** key. Select [OFF] to hide all tracks.
4. Press the **DISP** key to close the menu.

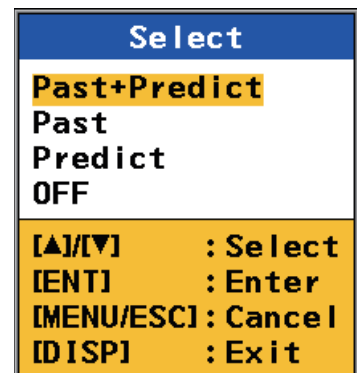

6.5.3 How to select the past track format

The past track can be shown with past track (ship) markers or solid line and past track markers. See the illustration at subsection 6.5.1.

1. Press the **MENU ESC** key to open the menu.
2. Select [Past Tracks] then press the **ENT** key.
3. Select [ON] or [OFF] then press the **ENT** key.
[ON]: Past track (ship) marker + solid line
[OFF]: Past track (ship) marker only
4. Press the **DISP** key to close the menu.

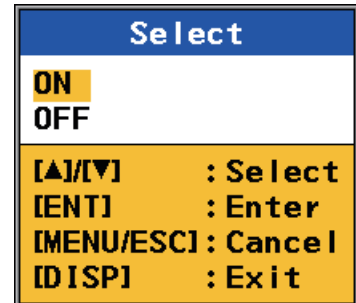

6.5.4 How to select the predicted track plot interval

Select the interval at which to plot the predicted track as follows:

1. Press the **MENU ESC** key to open the menu.
2. Select [Plot Time] then press the **ENT** key.
3. Select a time then press the **ENT** key. A new marker is plotted at equally time-spaced intervals of 1/5 of the plot time selected. For example, if you select the 10-minute interval, the predicted position is plotted at two-minute intervals.
4. Press the **DISP** key to close the menu.

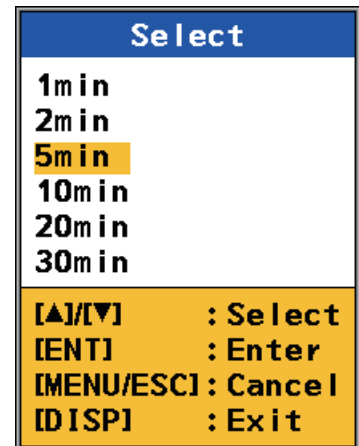

6.6 How to Show, Hide Navigation Data and 3-axis Speed Data

The berthing display can show NAV data and 3-axis speed data. You can show them in separate windows, show the 3-axis speed data in the NAV data window, or show only the 3-axis speed data (no NAV data). Long-push the **ENT** key to show or hide the data, in the sequence shown below.

The data can also be shown or hidden from the menu.

1. Press the **MENU ESC** key to open the menu.
2. Select [Scale Set Up] then press the **ENT** key.
3. Select [Data Display] then press the **ENT** key.
4. Select an option then press the **ENT** key.
5. Press the **DISP** key to close the menu.

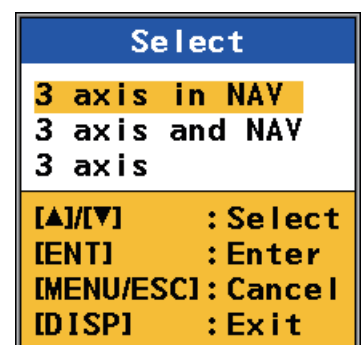

3-axis speed data* from the GS-100 in NAV data window

The data in dashed rectangle can not be displayed.

*: Press the **TRKG MODE** key to switch between SOG and STW.

3-axis speed data in NAV data (3 axis in NAV)
 ↓ Long-push ENT.

NAV data

The data in dashed rectangle can not be displayed.

3-axis speed data*

3-axis speed data and NAV data (3 axis and NAV)
 ↓ Long-push ENT.

3-axis speed data*

3-axis speed data, NAV data OFF (3 axis)
 ↓ Long-push ENT.

6.7 Berthing Line

Berthing lines, which can be used to assist in berthing operations, can be created and edited at the GS100. The saved lines can be sent to the DS-600 for display. A maximum of 100 lines can be saved in the GS-100 and each line can have up to three points.

6.7.1 How to register a berthing line

1. Press the **MENU ESC** key to open the main menu.
2. Select [7 System Setting] then [5 Berthing Line].



6. BERTHING DISPLAY

3. Select [1 List].

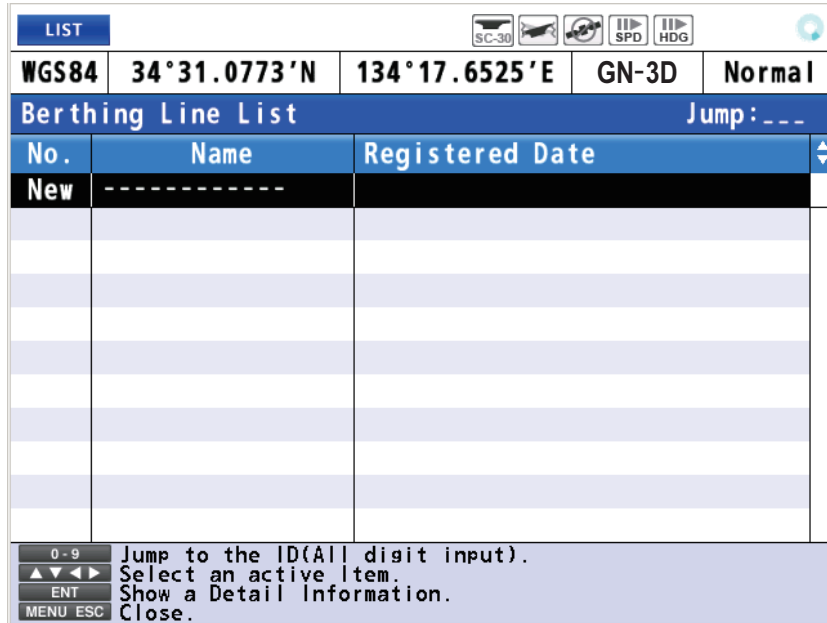

4. With the cursor at the [New] position, press the **ENT** key.

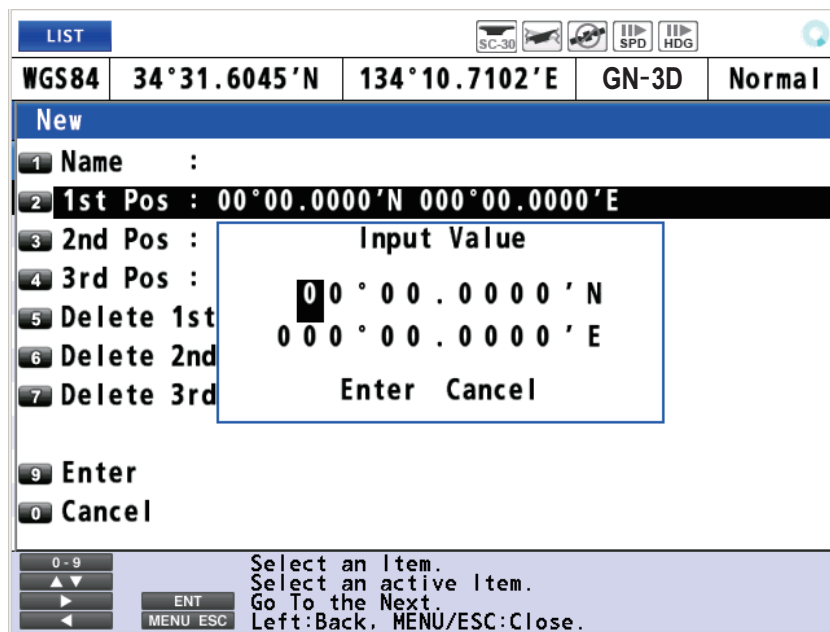

5. Enter the 1st position with the numeric keys. To change the coordinate, select "N" or "E" then press one of keys from **0** to **9**.
6. Move the cursor to [Enter] then press the **ENT** key.
7. Select [3 2nd Pos] or [4 3rd Pos] then press the **ENT** key. Enter the 2nd or 3rd position as well as the 1st position.
Note: Enter each value so that the difference between two positions is less than 1°.
8. Select [1 Name] then press the **ENT** key.
9. Enter the name for a berthing line referring to step 5 at subsection 3.8.3.
10. Move the cursor to [Enter] then press the **ENT** key.

11. Select [9 Enter].

Note: It is necessary to enter a name and at least two positions in order to register a berthing line.

LIST				
WGS84	34°13.3910'N	134°15.6432'E	GN-3D	Normal
Berthing Line List				Jump: ---
No.	Name	Registered Date		
New	-----			
001	BERTHING1	12:05'55 15/Apr/2014		
0-9	Jump to the ID(All digit input).			
▲▼◀▶	Select an active item.			
ENT	Show a Detail Information.			
MENU ESC	Close.			

12. Press the **MENU ESC** key to close the setting window.

6.7.2 How to edit a berthing line

1. Press the **MENU ESC** key to open the main menu.
2. Select [7 System Setting] then [5 Berthing Line].
3. Select [1 List].
4. Select the berthing line to edit then press the **ENT** key.
5. Select an option to edit then press the **ENT** key.
6. Change the name or position as appropriate.
7. Select [9 Enter].
8. Press the **MENU ESC** key to close the setting window.

6.7.3 How to delete a point or a line

1. Press the **MENU ESC** key to open the main menu.
2. Select [7 System Setting] then [5 Berthing Line].
3. Select [1 List].
4. Select the berthing line to delete then press the **ENT** key.
5. To delete a point, select [5 Delete 1st Point], [6 Delete 2nd Point] or [7 Delete 3rd Point]. Go to step 6.
To delete a berthing line, select [8 Delete Line]. Go to step 7.
6. Select [9 Enter].
7. Press the **MENU ESC** key to close the setting window.

6.7.4 How to send the berthing lines data to DS-600

To display the berthing lines on the display of the DS-600, do the following.

Note: Turn on the DS-600 before doing the following procedures.

1. Press the **MENU ESC** key to open the main menu.
2. Select [7 System Setting] then [5 Berthing Line].
3. Select [2 Share].
4. Press the **MENU ESC** key to close the main menu.

7. MAINTENANCE, TROUBLE-SHOOTING

NOTICE

Do not apply paint, anti-corrosive sealant or contact spray to plastic parts or equipment coating.

Those items contain products that can damage plastic parts and equipment coating.

7.1 Maintenance

Regular maintenance is important to maintain performance. Check the following points to help maintain performance.

- Check that connectors on the rear panel are firmly tightened and free of rust.
- Check that the ground system is free of rust and the ground wire is tightly fastened.
- Check that battery terminals are clean and free of rust.
- Dust or dirt may be removed from the cabinet with soft cloth. Water-diluted mild detergent may be used if desired. DO NOT use chemical cleaners to clean the display unit; they may remove paint and markings.
- Wipe the display carefully to prevent scratching, using tissue paper and a display cleaner. To remove dirt or salt deposits, use a display cleaner, wiping slowly with tissue paper so as to dissolve the dirt or salt. Change paper frequently so the salt or dirt will not scratch the display. Do not use solvents such as thinner, acetone or benzene for cleaning. Also, do not use degreaser or antifog solution, as they can strip the coating from the display.

7.2 Fuse Replacement



WARNING

Use the proper fuse.

A wrong fuse can damage the equipment and cause fire.

Junction box GS-1003

The junction box GS-1003 has a fuse that protects the GS-1003 from overcurrent and equipment fault. If you cannot turn on the power, check the fuse to see if it has blown. Find the reason for the blown fuse before you replace the fuse. If the fuse blows again

7. MAINTENANCE, TROUBLESHOOTING

after the replacement, contact your dealer for information. A wrong fuse can damage the equipment.

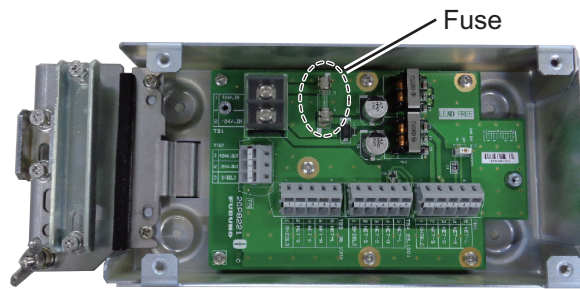

GS-1003

Name	Type	Code No.
Glass tube fuse	FGMB-A 125V 3A PBF	000-157-481-10

Display unit DS-600

The fuse in the display unit DS-600 protects the unit from overcurrent. If you cannot turn on the power, have a technician check if the fuse inside the display unit has blown. If the fuse has blown, find the cause before replacing the fuse. If the fuse blows again, contact your dealer.

Name	Type	Code No.
Glass tube fuse	FGMB-A 125V 2A PBF	000-157-479-10

7.3 Consumable Parts

Life of LCD for the GS-1002









The life of the LCD is approximately 60,000 hours. The actual number of hours depends on ambient temperature and humidity. When the brilliance cannot be raised sufficiently, ask your dealer about replacement.

Backlight for the DS-600

The life of the backlight is approximately 30,000 hours at the temperature of 55°C. When the brilliance cannot be raised sufficiently, ask your dealer about replacement for the panel/LCD assembly (Type: DS-600 PNL/LCD, Code No.: 001-098-070).

7.4 Troubleshooting

This section provides simple troubleshooting procedures which the user can follow to restore normal operation. If you cannot restore normal operation, do not attempt to check inside the unit. Any trouble should be referred to a qualified technician.

Symptom	Remedy
You cannot turn on the power.	<ul style="list-style-type: none"> • Check for damaged power cable and connector. • Check if the power cable is firmly fastened. • Check the battery for proper voltage output.
No picture appears.	Press the BRILL key followed by the cursorpad (▶) to increase the display brilliance.
There is no response when a key is pressed.	Turn off and on the power. If no change, ask your dealer.
Position is not fixed	<ul style="list-style-type: none"> • Check if the antenna connector is firmly fastened. • Check the number of satellites on the integrity display. If there are two or less, check for obstructions between antenna unit and satellites.
Position is wrong.	Check if the correct geodetic chart system is correctly selected on the [7 System Setting] - [1 System] - [4 Datum] menu.
Data are not transmitted to external equipment.	<ul style="list-style-type: none"> • Check if the data format is correct on the [5 I/O] menu. • The TX interval may be set to off. Select the proper interval. • Check the appropriate settings on the external equipment. • Check the connections: <ul style="list-style-type: none"> • Connect the TD-A of the GS-100 to the RD-A of the external equipment. • Connect the TD-B of the GS-100 to the RD-B of the external equipment.
Heading output stops because of the antenna location.	<p>Check the antenna location.</p> <ul style="list-style-type: none"> • Check for interfering objects near the antenna. • Check the installation site and mounting base for vibration. • Check for antenna of radar, radio equipment, etc. near the installation site.
The icon shown in the right appears on the display.	<ul style="list-style-type: none"> •   : The SC-30 is installed. Mount the GS-1001. •   : The SC-33 is installed. Mount the GS-1001B. •   : The antenna acceleration is over 5G. When these icons appear frequently, change the antenna location or implement the anti-vibration measures. •   : The common satellite for antenna 1 and 2 is blocked. Try to change the antenna location.

7.5 Equipment Information

You can display the information of this equipment from the menu.

1. Press the **MENU ESC** key to open the main menu.
2. Select [4 Maintenance] then [1 Information].

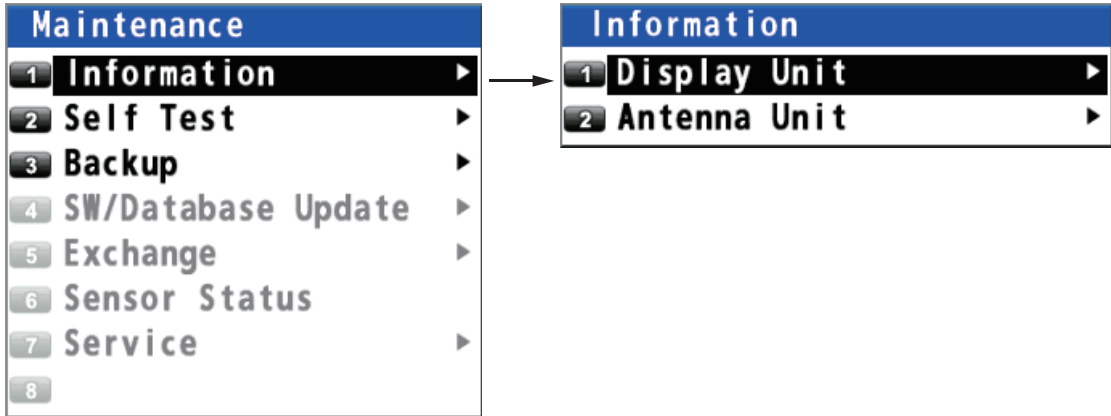

3. Select [1 Display Unit] or [2 Antenna Unit].

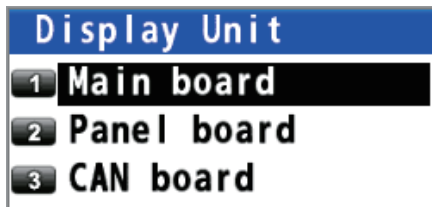

[1 Display Unit]

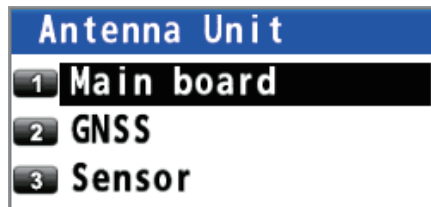

[2 Antenna Unit]

4. Select the information to display.

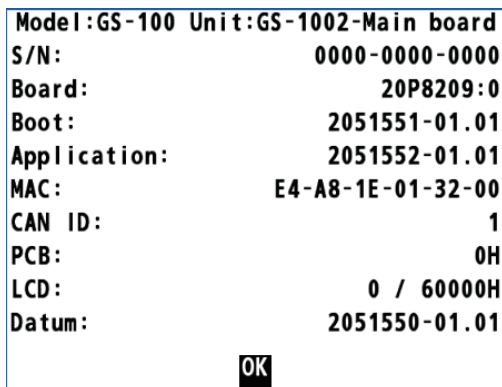

Main board for display unit

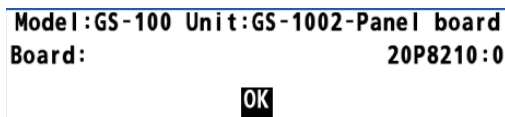

Panel board for display unit

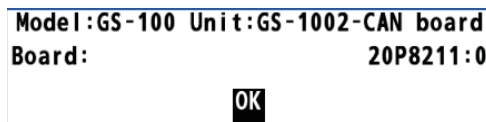

CAN board for display unit

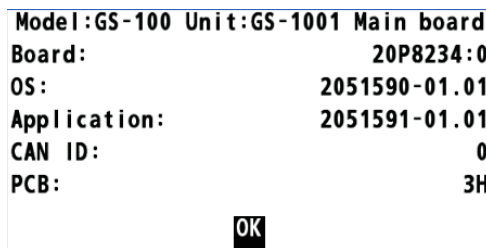

Main board for antenna unit

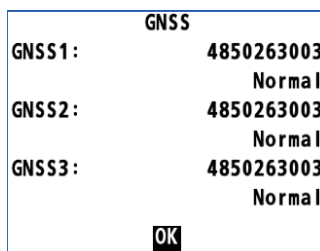

GNSS for antenna unit

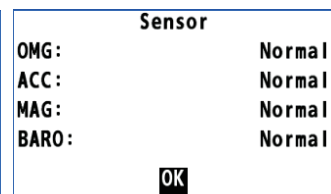

Sensor for antenna unit

5. Press the **ENT** key to close each information window.
6. Press the **MENU ESC** key to close the main menu.

7.6 Self Test

The self test checks the ROM, RAM, input/output data, GNSS core, keyboard, LCD performance and sound. The user can do the tests to help the service technician in troubleshooting.

Memory

1. Press the **MENU ESC** key to open the main menu.
2. Select [4 Maintenance] then [2 Self Test].

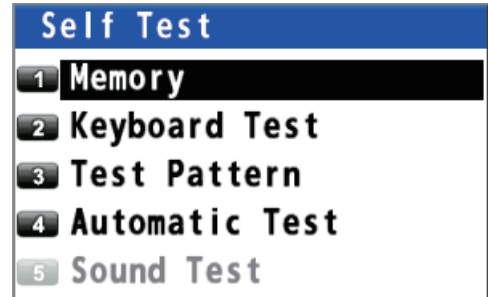

3. Select [1 Memory].
4. Press the **MENU ESC** key to close the memory test window.

Self Test: memory, I/O, Data Test	
Restart: Push "ENT" or "入力" key	
Exit: Push "MENU ESC" or "メニュー戻る" Key	
Start Time: 2021. 01. 17 11:37	
GS-1002	GS-1001
ROM: OK 2021. 01. 17 11:37	ROM: OK 2021. 01. 17 11:37
RAM: OK 2021. 01. 17 11:37	RAM: OK 2021. 01. 17 11:37
USB: --	GNSS1, 2, 3
Data1: --	ROM: OK 19C0. 19C0. 19C0
Data2: --	RAM: OK. OK. OK 2021. 01. 17 11:37
Data3: --	ANT: N/A. N/A
Data4: --	Sensor
LAN: OK PHY is OK.	OMG : OK 2021. 01. 17 11:37
	ACC : OK 2021. 01. 17 11:37
	MAG : OK 2021. 01. 17 11:37
	BARO: OK 2021. 01. 17 11:37

Keyboard test

The keyboard test checks the controls on the operation panel for proper operation.

1. Press the **MENU ESC** key to open the main menu.
2. Select [4 Maintenance] then [2 Self Test].
3. Select [2 Keyboard Test].
4. Press each key one by one. A key's corresponding location on the display turns blue if the key is normal. To do the keyboard test again, long-press the **ENT** key.
5. Press the **MENU ESC** key three times to close the keyboard test window.

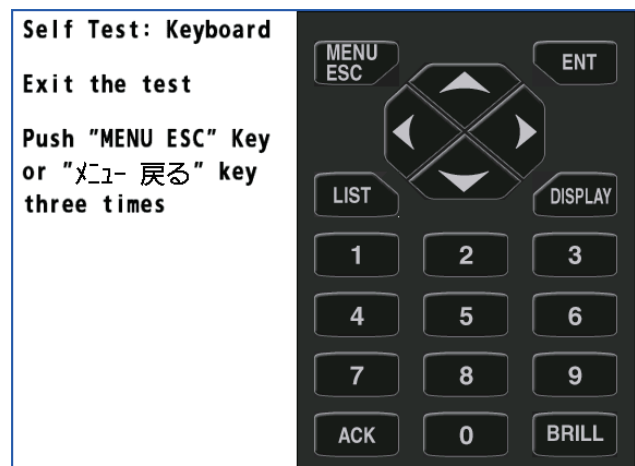

LCD test

The LCD test checks for proper display of colors.

1. Press the **MENU ESC** key to open the main menu.
2. Select [4 Maintenance] then [2 Self Test].
3. Select [3 Test Pattern]. The operation instructions display opens.

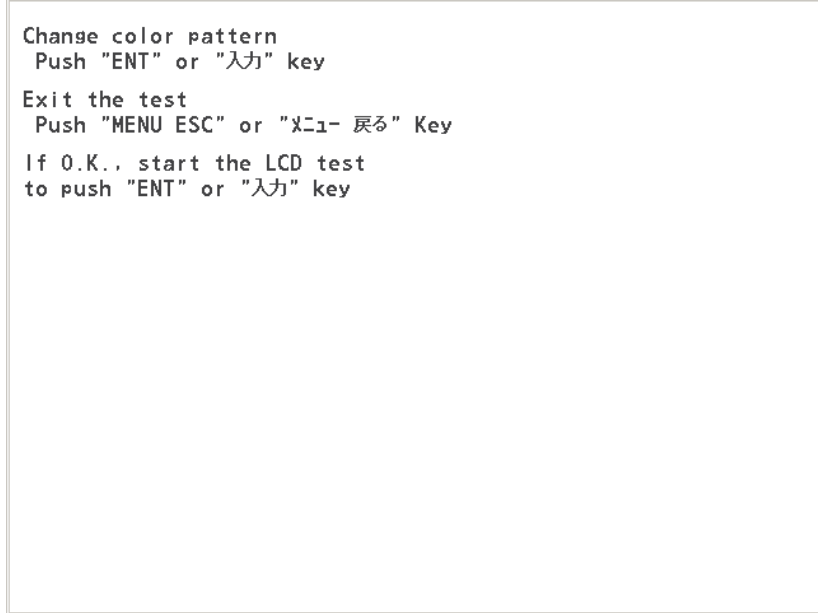

4. Press the **ENT** key. Each press of this key changes the LCD pattern in the sequence shown below.

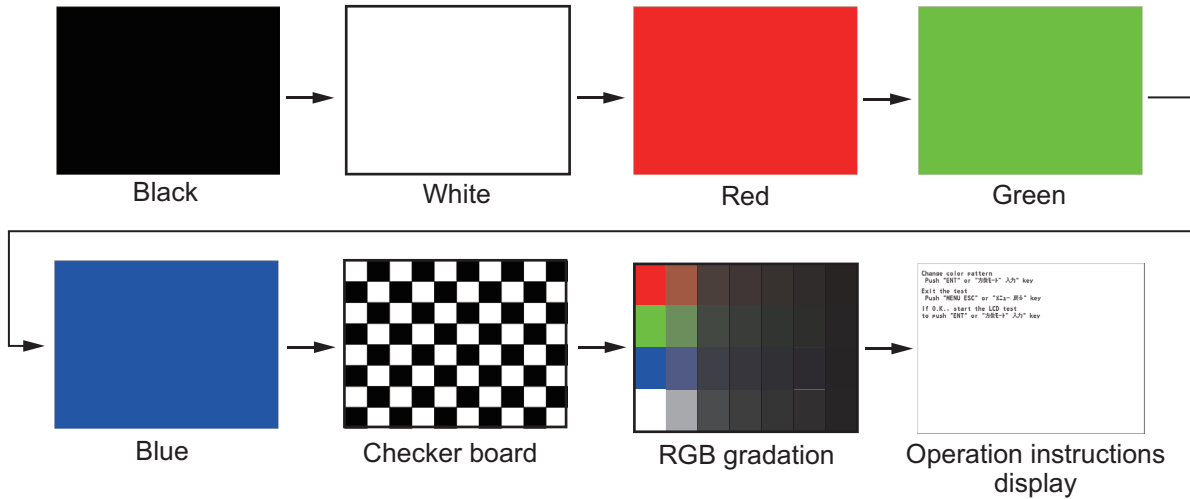

Note: You can cancel the test at any time by pressing the **MENU ESC** key.

5. Press the **MENU ESC** key to close the test pattern window.

Automatic test

The memory, keyboard and LCD tests are automatically tested.

1. Press the **MENU ESC** key to open the main menu.
2. Select [4 Maintenance] then [2 Self Test].

3. Select [4 Automatic Test]. The GS-100 automatically repeats the following sequence. A beep sounds when a test screen is switched.
Information screen (see the following figure) → Memory → Keyboard → LCD

Model:GS-100		Unit:GS-1002	
Unit:GS-1001		Block:Main board	
Block:Main board		S.N	0000-0000-0000
Board	20P8234:0	Board	20P8209:0
OS	2051590-01.01	Boot	2051551-01.01
Application	2051591-01.01	Application	2051552-01.01
CAN ID	0	Mac	32-00-00-00-00-00
PCB	3H	CAN ID	1
		PCB	0H
		LCD	0 / 60000H
		Datum	2051550-01.01
GNSS1 SW.Ver.	4850263003	Block:Panel board	
Status	Normal	Board	20P8210:0
GNSS2 SW.VER.	4850263003		
Status	Normal	Block:CAN board	
GNSS3 SW.Ver.	4850263003	Board	20P8211:0
Status	Normal		
OMG	Normal		
ACC	Normal		
MAG	Normal		
BARO	Normal		

Note 1: You can cancel the test at any time when you press the **MENU ESC** key.

Note 2: If NG (No Good) appears for an item in the memory test results, the automatic test stops.

4. Press the **MENU ESC** key to close the test window.

Sound test

Note: This function is for a serviceman.

1. Press the **MENU ESC** key to open the main menu.
2. Select [4 Maintenance] then [2 Self Test].
3. Select [5 Sound Test].
4. Press the cursorpad (▲ or ▼) to select [Frequency] or [Voltage].
5. Press the cursorpad (◀ or ▶) to set the value then press the **ENT** key. The buzzer sounds.
6. Press the **MENU ESC** key to close the setting window.

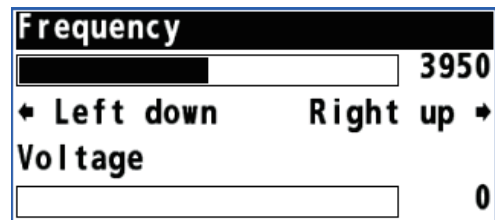

7.7 Backup

The GS-100 can save user settings (current settings for display, unit, I/O, etc.) to a USB flash memory. You can load the saved settings after clearing the memory, for example.

1. Set a USB flash memory in the USB port.
Note 1: Do not use an encrypted USB flash memory.
Note 2: Keep water away from the unit when the USB flash memory is inserted.
2. Press the **MENU ESC** key to open the main menu.

7. MAINTENANCE, TROUBLESHOOTING

3. Select [4 Maintenance] then [3 Backup].



4. Select [1 Backup User Setting] or [2 Load User Setting].

[Backup User Setting]: Saves the current settings to USB.

[Load User Setting]: Loads the saved settings from USB. This menu item requires the password.

The confirmation message appears.

Do you continue to do so?
It is not possible to cancel the running.

1 Yes 2 No

5. Select [1 Yes]. The message "Now Processing...." appears.

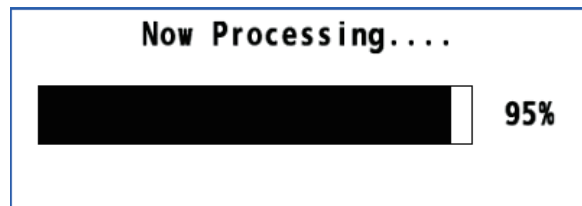

7.8 Replacement Parts Settings

Note: This function is for a serviceman.

7.8.1 How to reset the operating time for replacement parts

Before replacing an LCD or main panels for display or sensor unit, reset the usage hours indication for the replaced part.

1. Press the **MENU ESC** key to open the main menu.
2. Select [4 Maintenance] then [5 Exchange].

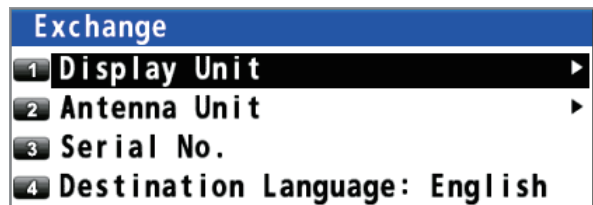

3. Select [1 Display Unit] or [2 Antenna Unit].

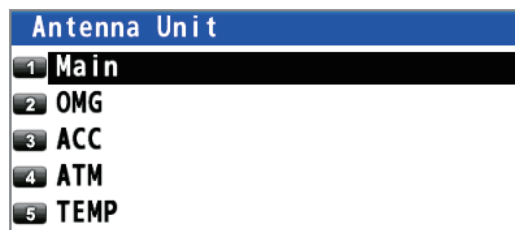

4. For [Display Unit], select [1 LCD] or [2 Main]. For [Antenna Unit], select [1 Main]. The confirmation message appears.

Do you continue to do so?

1 Yes 2 No

5. Select [1 Yes]. The message shown in the right figure appears.
6. Press the  key to turn the power off. When you turn the power on next time, the operating time for a replacement part is reset to 0.

Please turn off and power on!

7.8.2 Correction for the replaced sensor board

Set the rate gyro and acceleration through this menu only when installing the SUB IMU (sensor) board. It is not necessary to set the rate gyro when it is not available.

1. Press the **MENU ESC** key to open the main menu.
2. Select [4 Maintenance] then [5 Exchange].
3. Select [2 Antenna Unit].
4. Select [2 OMG] or [3 ACC].
OMG: Rate gyro
ACC: Acceleration

Correction Value input		
X axis	█	0 . 0 %
Y axis		0 . 0 %
Z axis		0 . 0 %
X axis Offset		0 0 0 0
Y axis Offset		0 0 0 0
Z axis Offset		0 0 0 0
	Enter	Cancel

5. Enter the correction value with the numeric keys as follows. The correction value is indicated on the seal attached to the rate gyro and acceleration.

Correction Value input		
X axis	0	0 . 0 %
Y axis		0 . 0 %

1) For example, to enter "+1.5", press the cursorpad (▶) to move the cursor here.

Correction Value input		
X axis	+	1 . 0 %
Y axis		0 . 0 %

2) Press the 1 key. The cursor moves here and "+" appears.

Correction Value input		
X axis	+	1 . 5 %
Y axis	█	0 . 0 %

3) Press the 5 key. The cursor moves here.

To switch between + and -, press the cursorpad (▲) to move the cursor here then press any numeric key.

4) Repeat 1) to 3) for other items.

6. Move the cursor to [Enter] then press the **ENT** key. The message "Processing..." appears. If normal, the last-used screen appears. If abnormal, the message "Response Error!!!" appears. If timeout occurred, the message "Time Out!!!" appears.

7. MAINTENANCE, TROUBLESHOOTING

This page is intentionally left blank.

8. INSTALLATION

8.1 Mounting

NOTICE

Do not apply paint, anti-corrosive sealant or contact spray to coating or plastic parts of the equipment.

Those items contain organic solvents that can damage coating and plastic parts, especially plastic connectors.

8.1.1 Display unit GS-1002

The display unit can be installed one of three ways, tabletop or flush mount (two types). Refer to the outline drawings at the end of this manual.

- Locate the unit away from the exhaust pipes and vents.
- The mounting location should be well ventilated.
- Mount the unit where shock and vibration are minimal.
- Keep the display unit away from electromagnetic field generating equipment such as motor, generator.
- Allow sufficient maintenance space and slack in cables for maintenance and repair.

Tabletop mounting

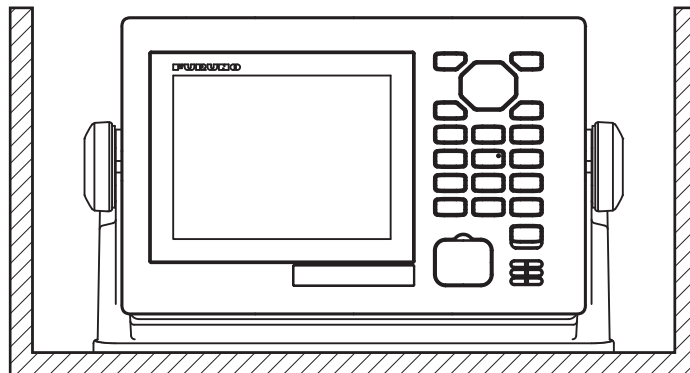

8. INSTALLATION

Flush mounting type S

The optional flush mount kit type S is required. (Name: Flush Mount Kit (S-type), Type: OP20-40, Code No.: 001-243-890)

Name	Type	Code No.	Qty
Spring Washer	M6 SUS304	000-158-855-10	2
Hexagonal Head Slot Bolt	M6×12 SUS304	000-162-897-10	2
Wing Nut	M4 YBSC2	000-168-239-10	4
Wing Bolt	M4×30 YBSC2	000-168-243-10	4
F(lush) Mounting Fixture	20-035-1062	100-381-290-10	2

1. Prepare a cutout in the mounting location whose dimensions are 242 (W) × 152 (H) mm.
2. Insert the unit to the cutout.
3. Attach two flush mounting fixtures to the unit with two hexagonal head slot bolts (M6×12) and two spring washers.
4. Screw four wing bolts to four wing nuts.
5. Fasten the unit with four wing bolts assembled at step 4, and then tighten four wing nuts.

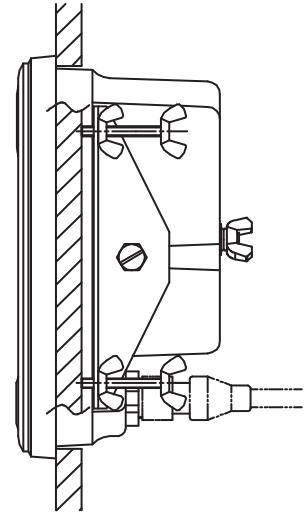

Flush mounting type F

The optional flush mount kit type F is required. (Name: Flush Mount Kit (F-type), Type: OP20-41, Code No.:001-243-900)

Name	Type	Code No	Qty
Spring Washer	M6 SUS304	000-158-855-10	2
Self-tapping Screw	5×20 SUS304	000-162-608-10	4
Hexagonal Head Slot Bolt	M6×12 SUS304	000-162-897-10	2
Panel	20-035-1061	100-380-480-10	1

8.1.2 Antenna unit GS-1001

General considerations

When selecting a mounting location, keep in mind the following points:

- Observe the compass safe distances shown in the Safety Instructions (page iii) to prevent interference to a magnetic compass.
- The vibration should be less than 1 G.
- The antenna unit must be mounted above all sensors other than a Inmarsat C.
- The sensor should be separated more than three meters from communication antennas.

To prevent the shading and multipath problems which occur as shown in the figure below, follow the procedure in the next topic "Mounting location" to select a mounting location.

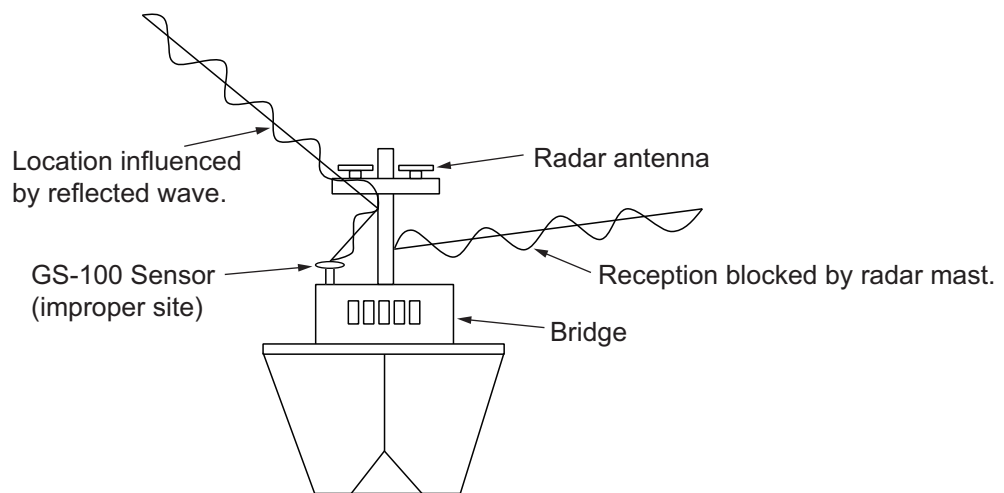

Mounting location

The mounting location must satisfy the following four conditions. After selecting the location, determine the mounting height, following the procedure in the next topic.

CONDITION 1: Locate the GS-100 sensor away from masts that might prevent reception of the GNSS signal

Mount the sensor where the field of view against zenith is at least $\pm 85^\circ$. The mounting location should be as high as possible, above masts, etc. that might interfere with reception.

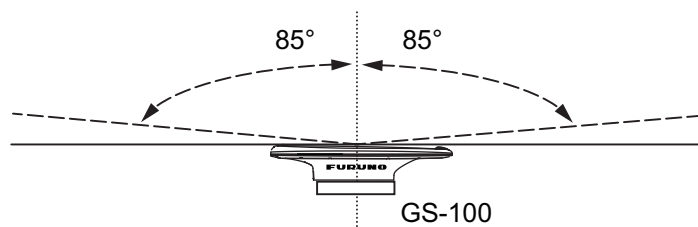

8. INSTALLATION

CONDITION 2: Locate the GS-100 higher than the top of radar and Inmarsat antennas*.

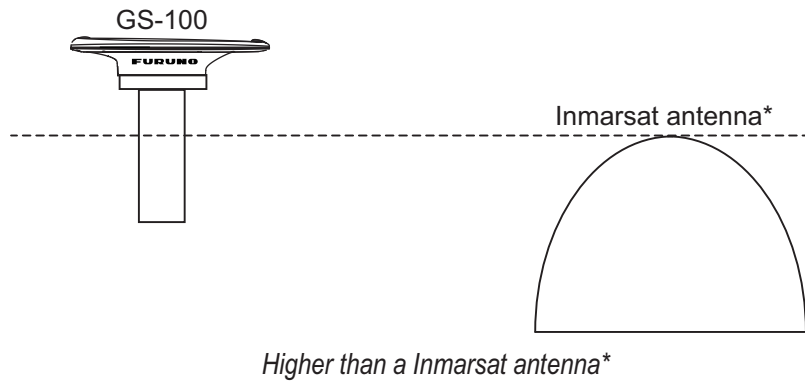
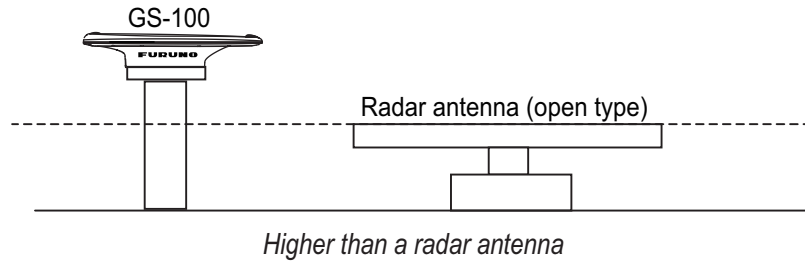

*: Other than a Inmarsat C

CONDITION 3: Locate the GS-100 sensor away from communication antennas
Separate the GS-100 as far as possible from communication antennas.

CONDITION 4: Select a stable location, one that does not resonate from engine noise or waves (The vibration should be less than 1 G)

Mounting procedure

Note 1: The bird-repellent fixtures (optional supply) can be attached to the antenna cover to prevent birds from landing on the cover. If it is more convenient to attach the bird-repellent fixtures before securing the antenna unit to the mounting location, do step 6 below before fixing the antenna unit.

Note 2: Depending on the installation location, connecting the antenna pig tale connector to a cable from the junction box in advance can make the installation easier. To connect the cable and waterproof the connection, see step 5 of the following procedure.

1. As shown in the figure below, weld a platform (local supply) for which to mount the sensor.

If corrosive material is used, take necessary anti-corrosion measures. The thickness of the platform should be 5 mm to 15 mm.

Note: Holes drilled into the mounting platform must be parallel with the fore-aft line of the vessel.

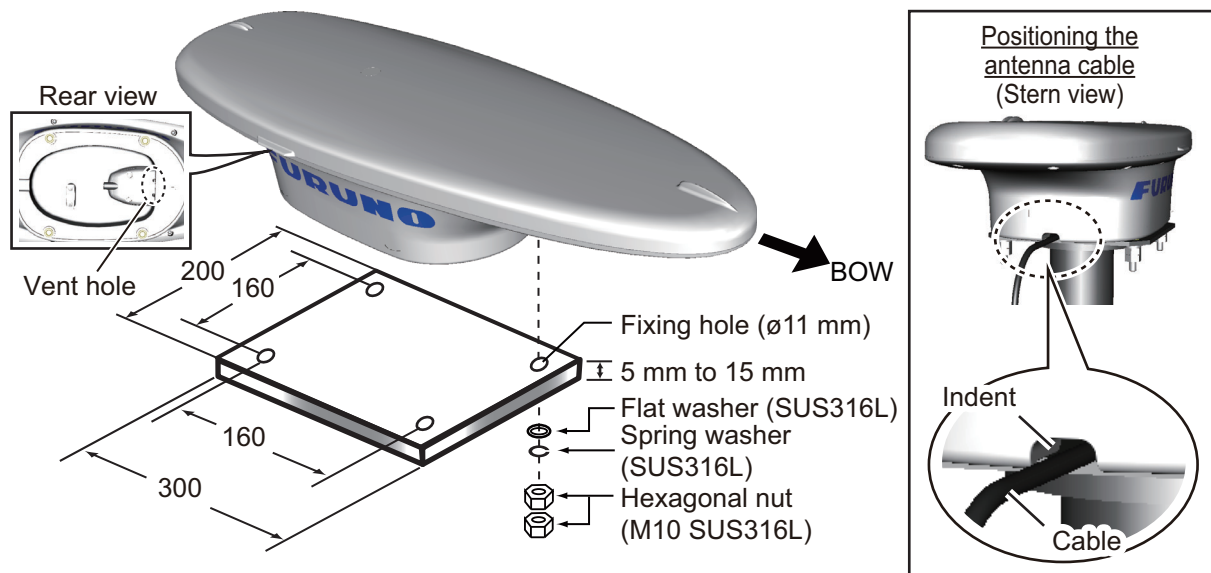

2. Orient the antenna unit to face the bow, referring to the figure above. The antenna should be installed within $\pm 2.5^\circ$ of the bowline.

Note 1: The antenna cable must be routed via the indent at the rear of the base (see the above figure).

Note 2: Take care not to cover the vent hole on the antenna.

3. Secure the unit to the platform with four sets of M10 hex. nuts, spring washers and flat washers (all included as installation materials) with 20 ± 2 N•m torque.

Note: Take care not to crush the cabling when mounting the antenna to the platform.

How to fasten double nuts

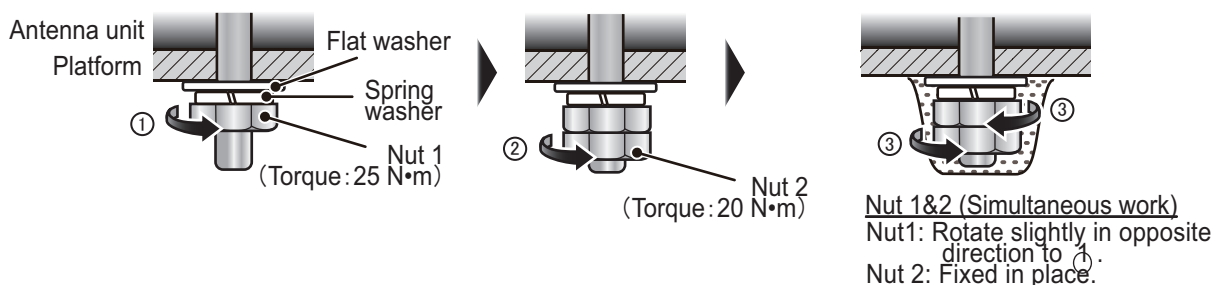

8. INSTALLATION

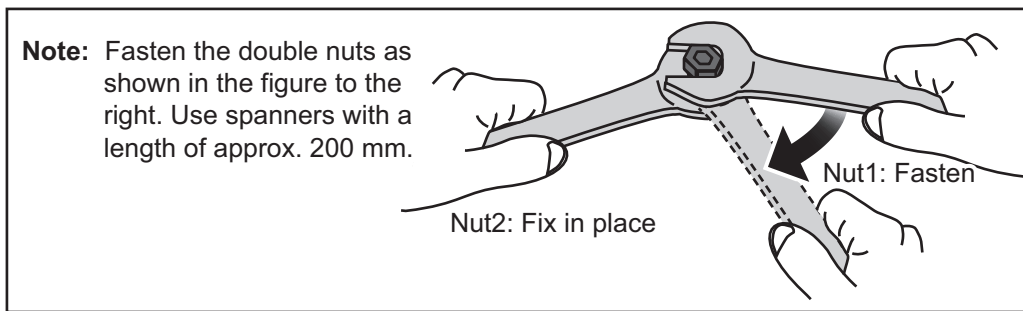

4. Coat the exposed parts of the nuts, bolts and washers with the Adhesive TB5211 (included) to prevent corrosion.

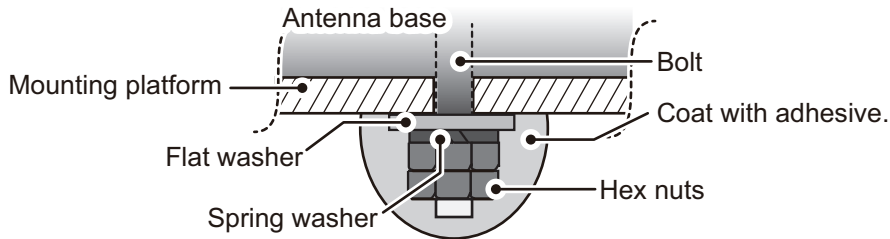

5. Connect the antenna pig tale connector to a cable from the junction box, then waterproof the connection. See section 8.2 for the wiring and section 8.2.3 for the waterproofing.
6. Remove the double-sided tape from the optional bird-repellent fixtures, then attach to the antenna cover. Coat around the bird-repellent fixtures with the Adhesive TB5211 (included).



7. Secure the satellite compass cable to the pipe at suitable intervals with the cable ties (included).

Note: Create a loop in the cable close to the satellite compass and tie the loop with a cable tie for maintenance work, as shown in the below figure.



Create a loop of more than 15 cm in diameter (approx. twice the length of a pigtail connector) so that the loop does not put stress on the pigtail connector.

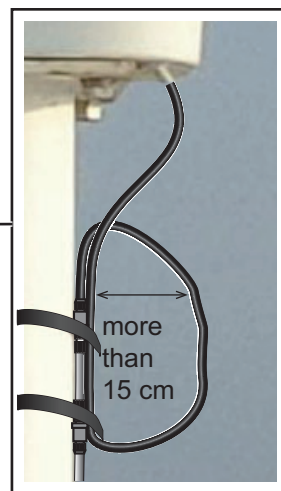

8.1.3 Junction box GS-1003

Mounting considerations

When selecting a mounting location, keep in mind the following points:

- Locate the junction box away from heat sources because of heat that can build up inside the cabinet.
- The vibration should be minimal.
- Locate the junction box away from places subject to water splash and rain.
- Make sure that the ground wire is connected between the earth terminal on chassis and the ship's earth.
- Leave sufficient space at the sides and rear of the unit to facilitate maintenance.
- A magnetic compass will be affected if the junction box is placed too close to the magnetic compass. Observe the compass safe distances at the front of this manual to prevent interference to a magnetic compass.

Mounting procedures

1. Unfasten four binding screws to remove the cover from the junction box.
2. Fasten four self-tapping screws (4×20, supplied) to fix the junction box to the mounting location.
3. Reattach the cover.

8.2 Wiring

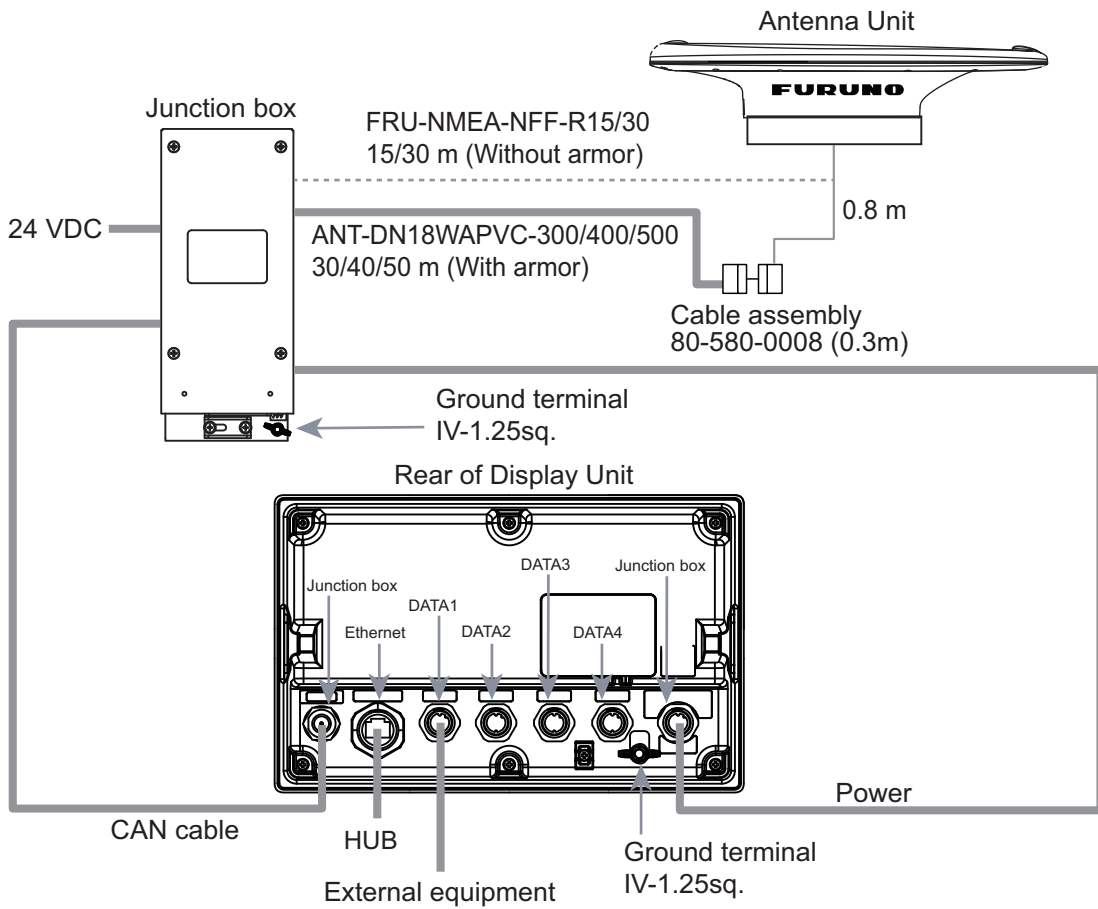

Connection of WAGO connector

Remove the WAGO connector from each unit and connect each cable core to the WAGO connector. See the interconnection diagram at the back of this manual. The terminal opener is attached inside each unit.

How to connect wires to WAGO connector

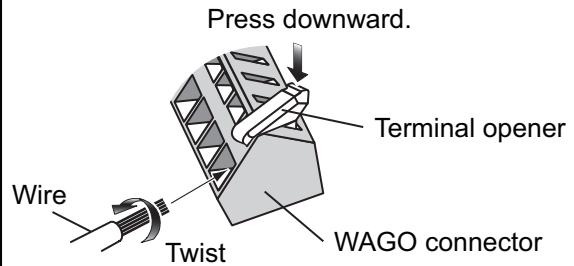

<Procedure>

1. Twist the cores.
2. Set and press the terminal opener downward.
3. Insert the wire to hole.
4. Remove the terminal opener.
5. Pull the wire to confirm that it is secure.

8.2.1 Junction box

Connections

Unfasten four screws to remove the cover, pass the cables through the clamps and attach the cables to respective connectors. The shield part of the cable (or drain wire) must lie in the clamp. The terminal opener is attached to the back of the cover.

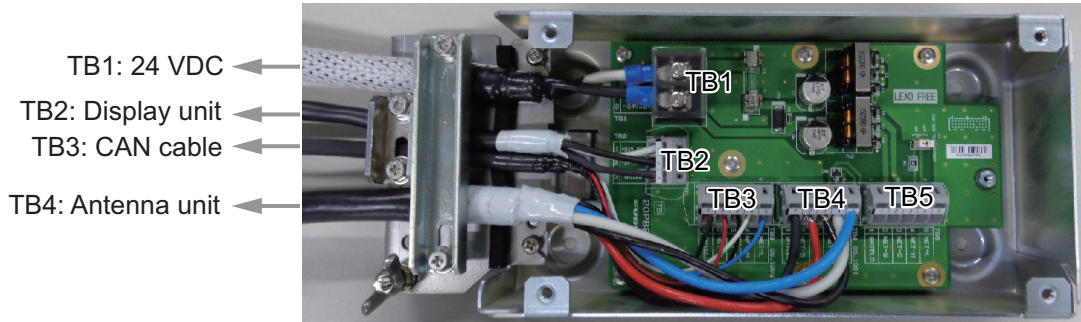

For fishing vessel specifications, fix the cable for the antenna unit to the clamp with the cable tie (CV-100N).

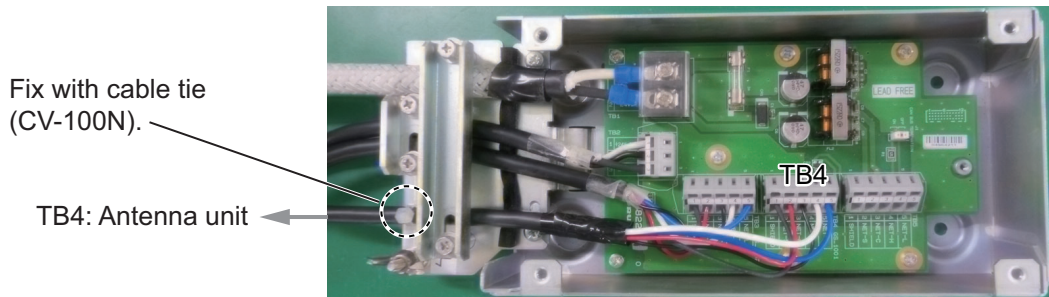

Fabrications

ANT-DN18WAPVC-300/400/500 cable

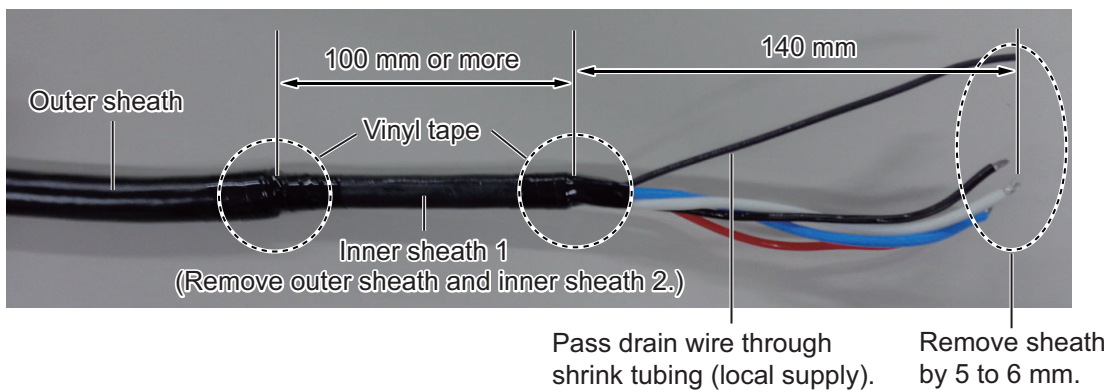

8. INSTALLATION

DPYC-1.5 cable

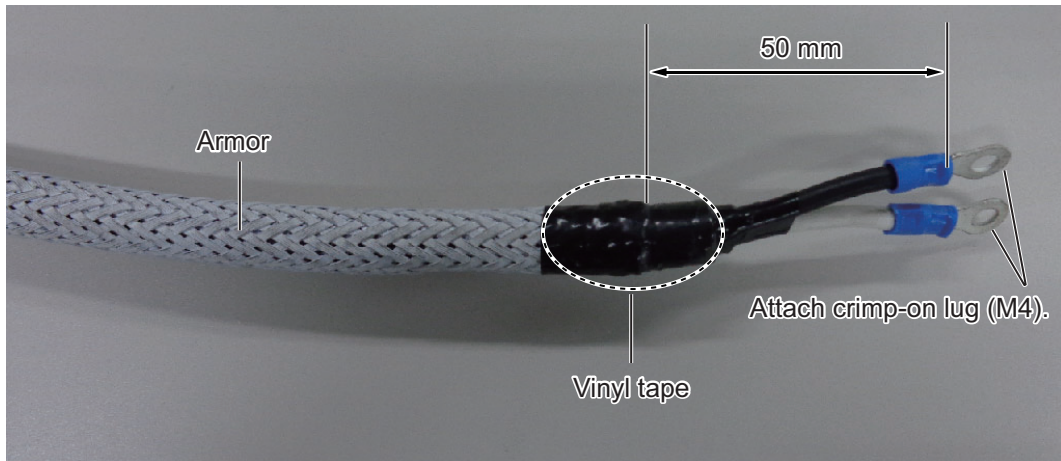

M12-05BFFM-060C

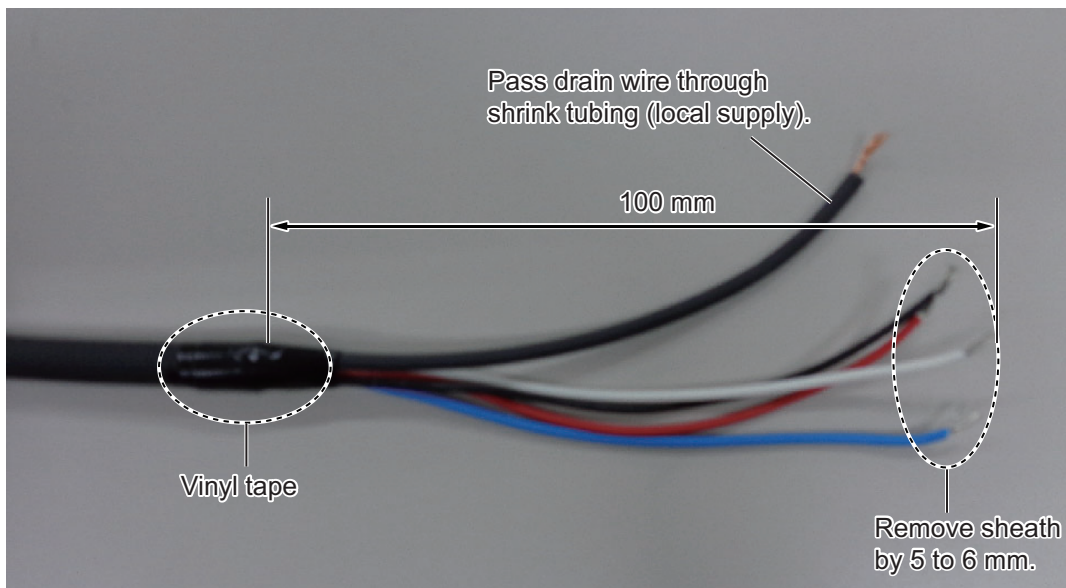

MJ-A3SPF0015-060C

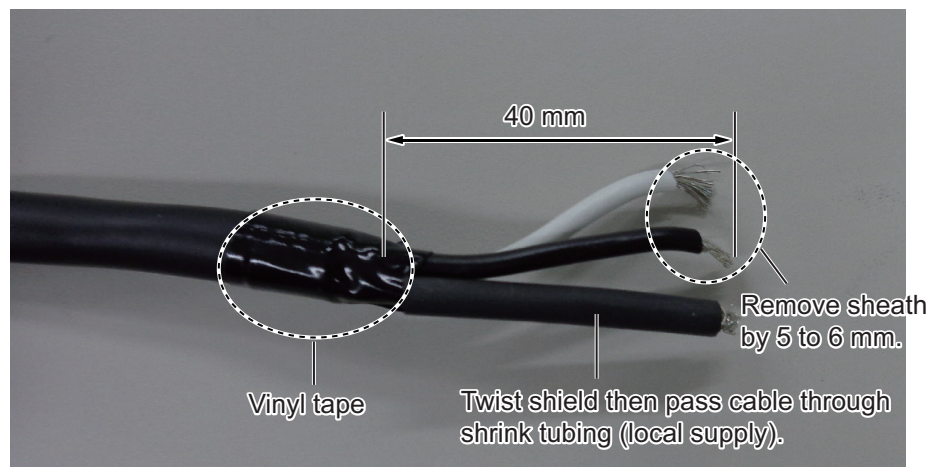

FRU-NMEA-NFF-R15/30 (For pleasure or fishing vessel use)

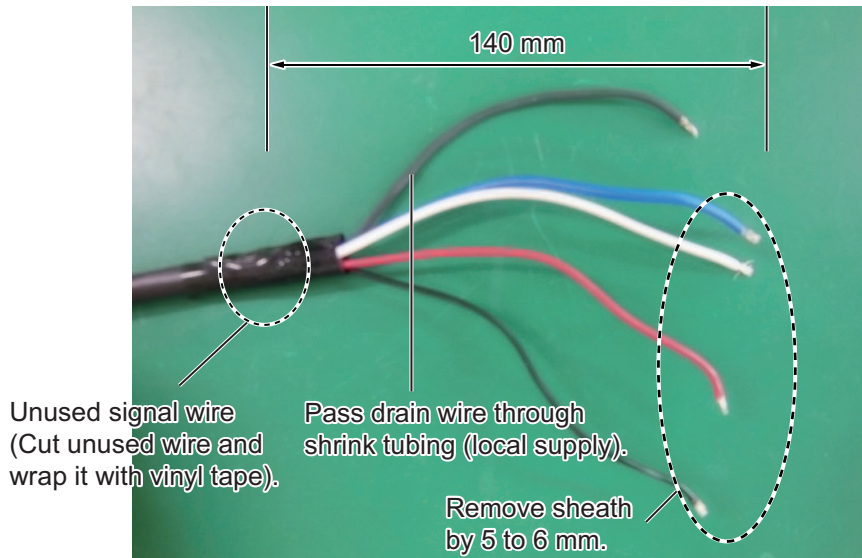

8.2.2 Display unit

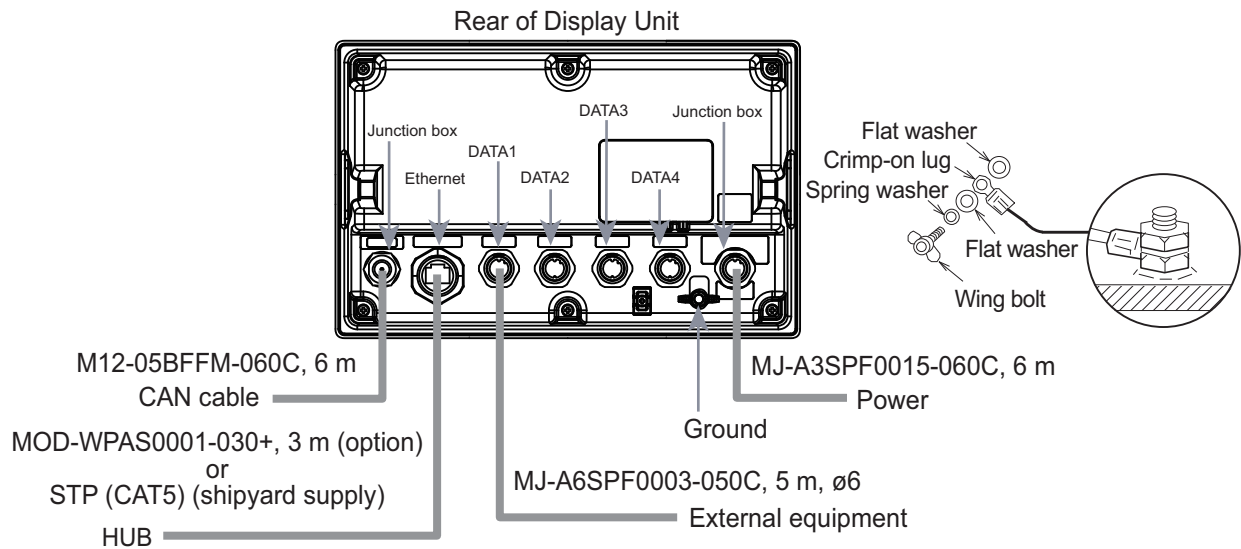

The display unit DS-600 (option) can be connected to the display unit GS-1002. For details, see the Installation Manual for DS-60.

Connection

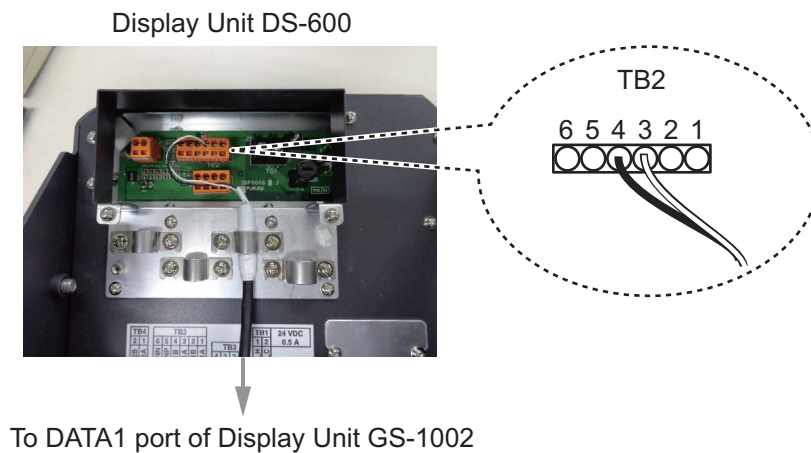

8. INSTALLATION

Fabrication

TTYCS-1

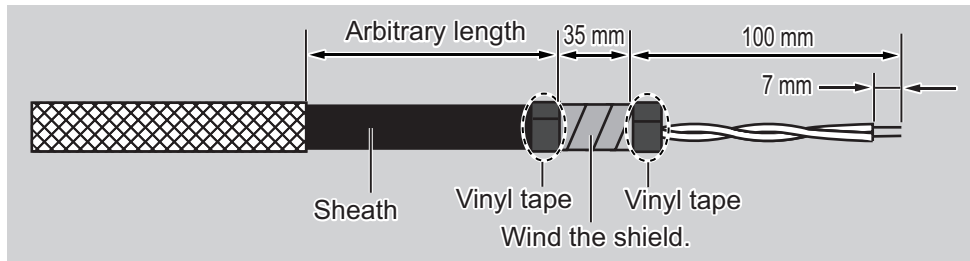

8.2.3 Antenna unit

Connection of the cable assembly “80-580-0008”

1. Connect the main cable and antenna cable to the cable assembly as shown in the figure below.

Note: Do not use pliers to tighten caps, otherwise the caps may be damaged. Use your fingers to tighten the connectors sufficiently. (0.39 to 0.49 N•m)

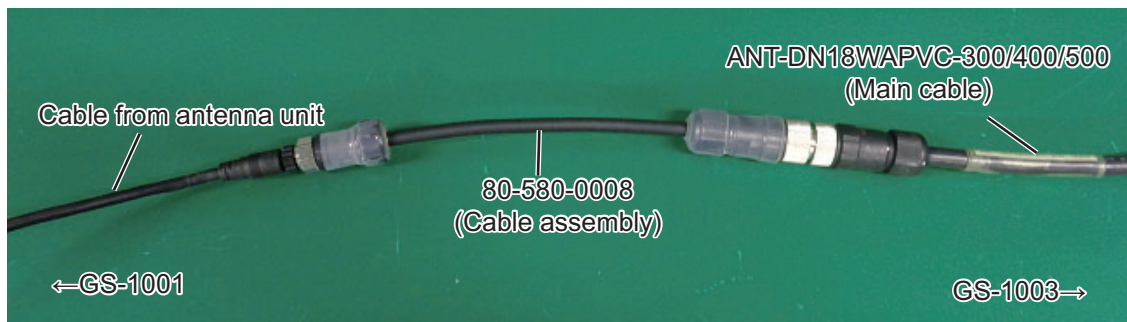

2. Wrap the cable assembly connectors with self-bonding tape and vinyl tape, for waterproofing, as outlined in the procedure below.
 - 1) Wrap the connectors with a single layer of vinyl tape, then wrap the connectors with self-bonding tape.

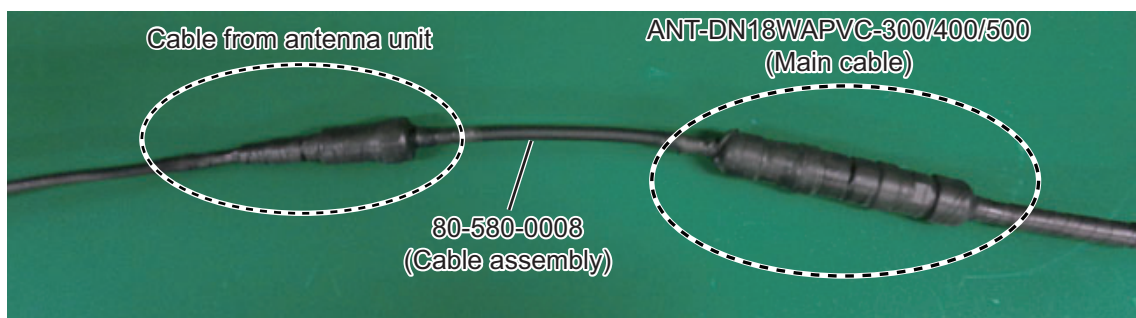

- 2) Wrap two layers of vinyl tape over the self-bonding tape.

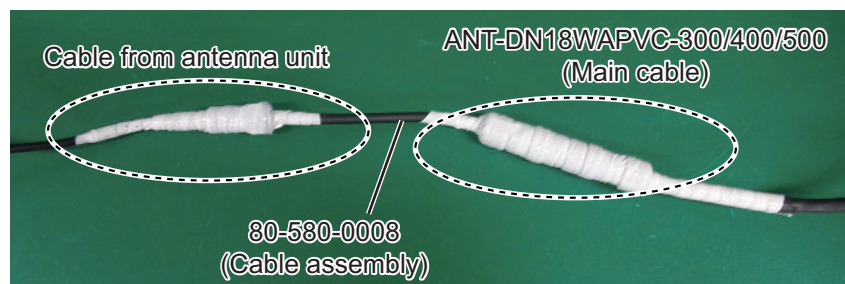

8.2.4 How to connect the Cable Replacement Kit (OP20-50)

Use a waterproof relay box (JPBS06) to relay connection when connecting to the GS-1001B with the MJ-A10SPF0015-150C/300C cable used in GS-1001.

- 1) Unfasten four washer head screws on the top of the waterproof relay box to remove the cover.



- 2) Fabricate the MJ-A10SPF0015-150C/300C as follows.

- 1) Cut the MJ-10 connector part. Expose inner vinyl sheath by approx. 40 mm. Be careful not to damage inner shield and cores.

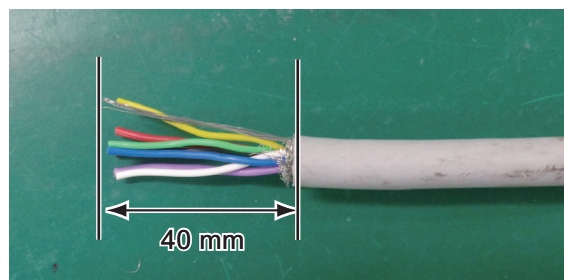

- 2) Cut unused wires (green, yellow and purple) to approx. 10 mm, then isolate them with vinyl tape. Wrap the drain wire with a vinyl tube.

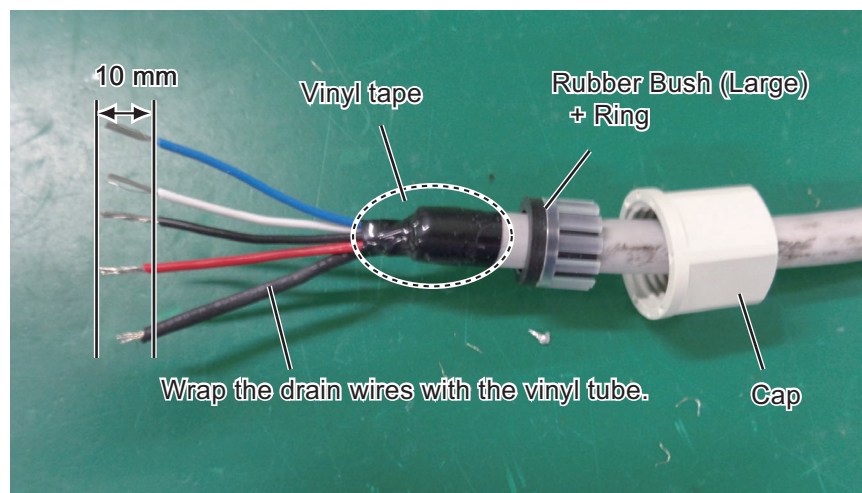

Note: Make sure the rubber bush and ring are oriented correctly (as shown in the figure above).

8. INSTALLATION

3) Fabricate the FRU-NMEA-PFF-060 cable as follows.

- 1) On the end of the side without the FRU connector, cut into the one end part of the FRU connector. Expose inner vinyl sheath by approx. 40 mm. Be careful not to damage inner shield and cores.

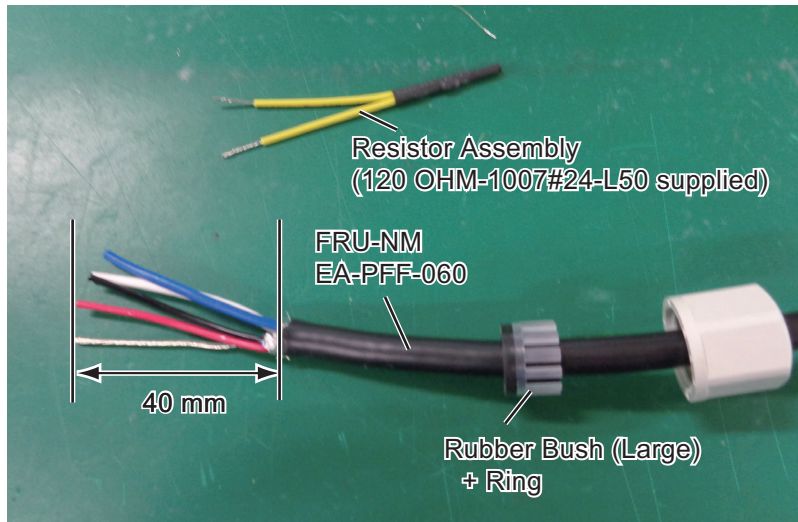

- 2) Wrap the drain wire with a vinyl tube.

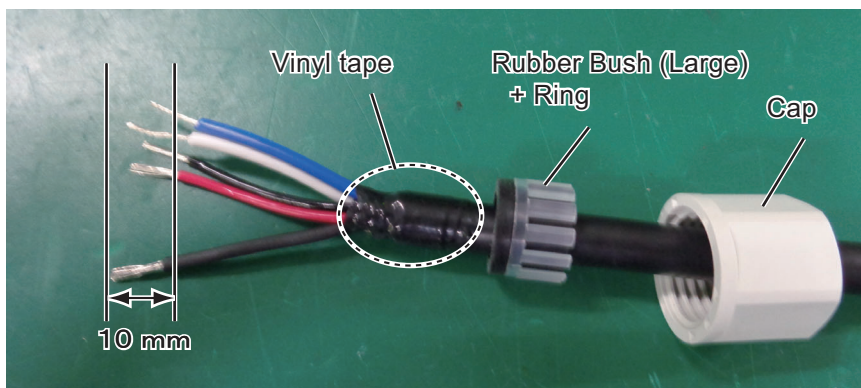

Note: Make sure the rubber bush and ring are oriented correctly (as shown in the figure above).

- 3) Twist the blue and white core wires and a resistor assembly, and attach a closed-end lug to the wires.

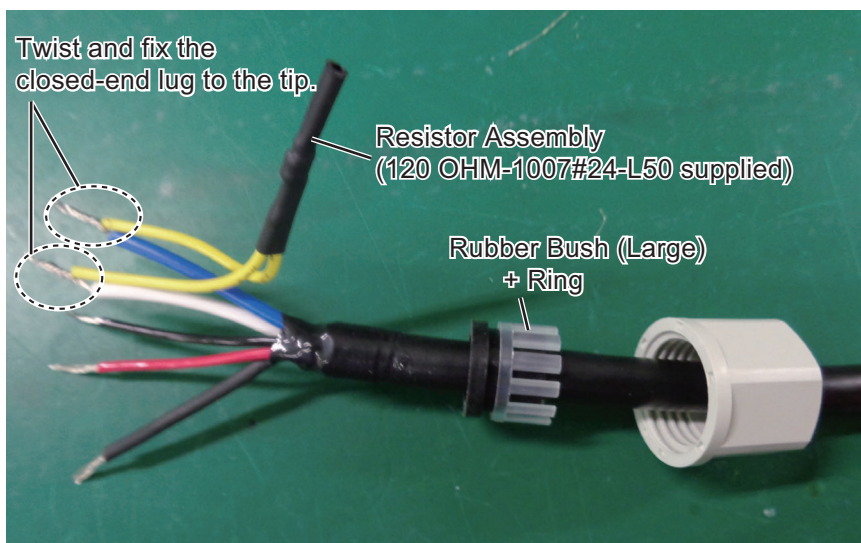

- 4) Connect the cables to the waterproof relay box.
Connect the CAN cable (FRU-NMEA-PFF-060) included to the cable replacement kit and the cable for GS-1001 (MJ-A10SPF0015-150C/300C) to the internal terminal box.

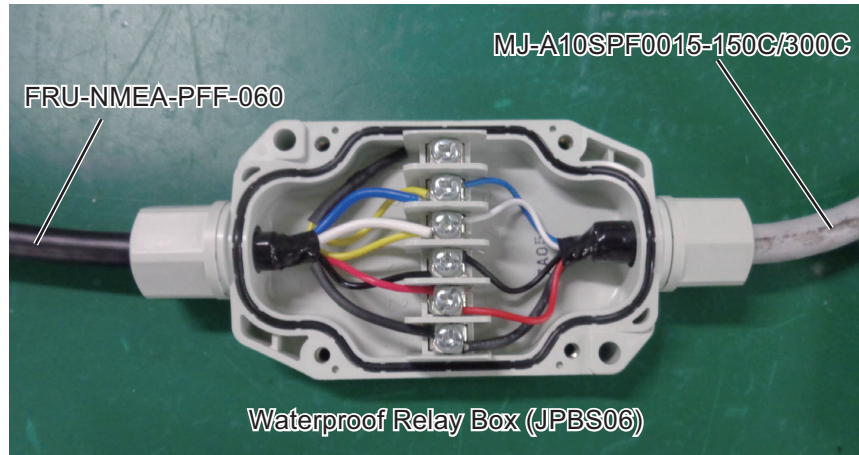

- 5) Fit the rubber bush, ring and cap, in that order. Make sure the order is as shown in the below figure, to keep the IP rating.

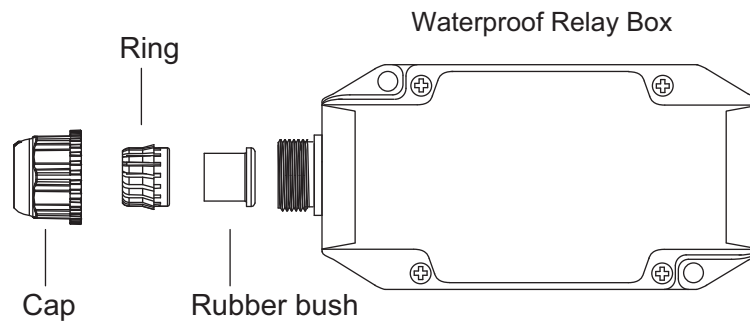

- 6) Fit the cover to the waterproof relay box, then secure the cover with the four washer screws removed at step 1.



8.2.5 How to secure and waterproof the cable connections

Cable connection for the waterproof relay box, whether exposed to weather or otherwise, should be waterproofed and secured after making the connection.



- 1) Wrap the cap with several layers of self-bonding tape (supplied), to reduce the height difference between the cap and the box.



- 2) Starting at approximately 40 mm from the both caps, wrap the cap and waterproof relay box with three layers of self-bonding tape.

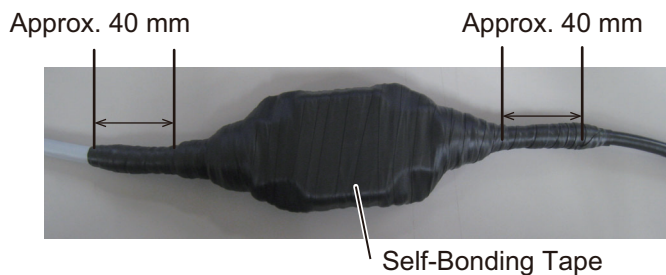

Note: Take care that the self-bonding tape is not cut on the waterproof relay box or cap edges.

- 3) Wrap two layers of vinyl tape, in opposite direction, to cover the self-bonding tape.



8.3 Adjustments

8.3.1 Language

The available languages are English and Japanese.

1. Press the **MENU ESC** key to open the main menu.
2. Select [7 System Setting] then [6 Language/言語].
3. Select [1 English].
4. Press the **MENU ESC** key to close the main menu.



8.3.2 Device mode

There are two display modes, [SDME] and [THD]. Only a serviceman can switch these modes, at the installation.

1. Press the **MENU ESC** key to open the main menu.
2. Select [7 System Setting] then [3 Tech Menu].
3. Select [6 Device Mode].
4. Select [SDME] or [THD].
[SDME]: Enables the SDME mode.
[THD]: Enables the THD mode.
5. Press the **MENU ESC** key to close the main menu.

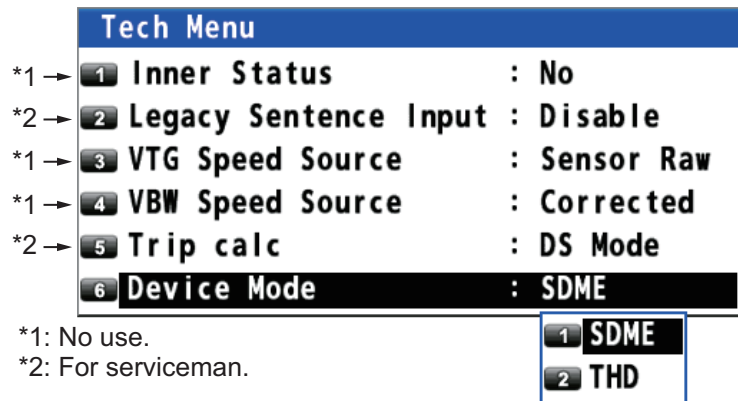

8.3.3 Unit

You can set the units of measurement for distance, depth and ship's speed.

1. Press the **MENU ESC** key to open the main menu.
2. Select [7 System Setting] then [1 System].

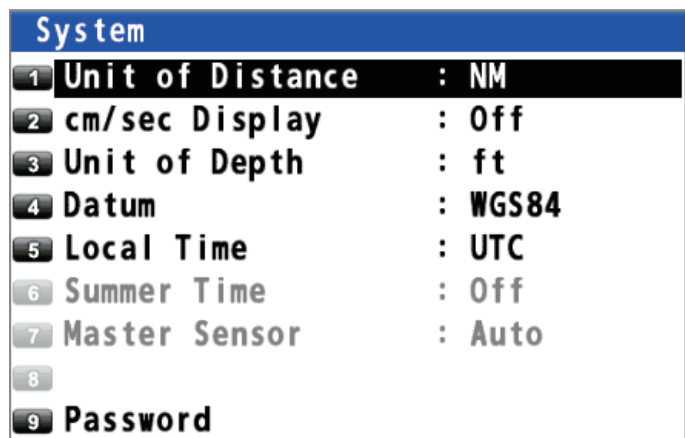

8. INSTALLATION

3. Select [1 Unit of Distance] or [3 Unit of Depth] and go to step 4, or select [2 cm/sec Display] and go to subsection 3.1.3.



Distance



Depth

4. Select the unit.
The unit of the own ship's speed changes, depending on the selection at [1 Unit of Distance] as follows:

[1 NM]: kn

[2 km]: km/h

[3 SM]: SM/h

5. Press the **MENU ESC** key to close the main menu.

8.3.4 Datum

Your unit is programmed to recognize most of the major chart systems of the world. Although the WGS-84 system, the GPS standard, is now widely used other categories of charts still exist. Select the same datum which is used in your nautical charts.

1. Press the **MENU ESC** key to open the main menu.
2. Select [7 System Setting] then [1 System].
3. Select [4 Datum].
4. Select an option. For [6 Other], go to step 5. For others, go to step 7.

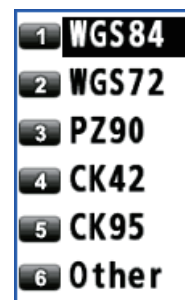

5. Enter the datum number with the numeric keys.
6. Move the cursor to [Enter] then press the **ENT** key.
7. Press the **MENU ESC** key to close the main menu.

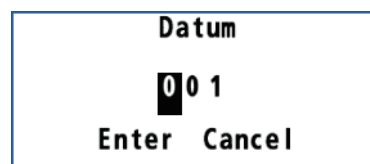

8.3.5 Time format

UTC or Local

1. Press the **MENU ESC** key to open the main menu.
2. Select [7 System Setting] then [1 System].
3. Select [5 Local Time].
4. Select [1 UTC] or [2 Local]. For [2 Local], go to step 5. For [1 UTC], go to step 7.
5. Enter the difference time with the numeric keys. To switch between + and -, select it then press one of keys from **0** to **9**.
6. Move the cursor to [Enter] then press the **ENT** key.
7. Press the **MENU ESC** key to close the main menu.

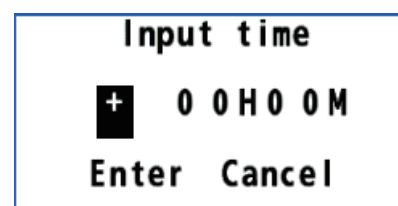

Summer time

Note: This menu is available when selecting [Local] in the [Local Time] menu.

1. Press the **MENU ESC** key to open the main menu.
2. Select [7 System Setting] then [1 System].
3. Select [6 Summer Time].
4. Select [1 On] to use summer time.
5. Press the **MENU ESC** key to close the main menu.



8.3.6 Equipment ID

The equipment ID is identification for system.

1. Press the **MENU ESC** key to open the main menu.
2. Select [7 System Setting] then [2 Network].

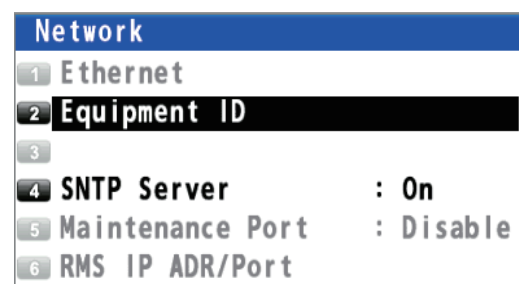

3. Select [2 Equipment ID].
4. Enter the ID with the numeric keys.
5. Move the cursor to [Enter] then press the **ENT** key.
6. Press the **MENU ESC** key to close the main menu.

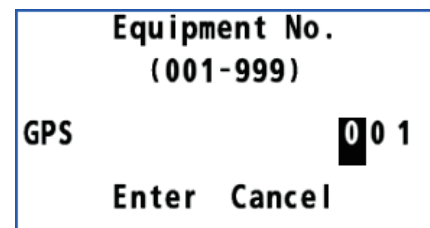

8.3.7 Offset menu

Note: This menu is for a serviceman.

Heading, Pitch or Roll offset

You may apply an offset to the heading, pitch, roll and position to further refine their accuracy.

1. Press the **MENU ESC** key to open the main menu.
2. Select [6 Sensor Setting] then [1 Offset].
3. Select [1 HDG Offset], [2 Pitch Offset] or [3 Roll Offset]. After entering the password, the following setting window appears.

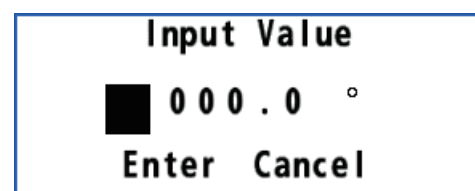

8. INSTALLATION

4. Enter the offset value with the numeric keys referring to as follows:

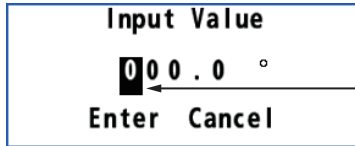

1) For example, to enter "+10.0°", press the cursorpad (▶) to move the cursor here.

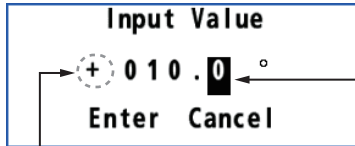

2) Press the 0, 1, 0, 0 keys. When inputting positive number, "+" appears.

To switch between + and -, press the cursorpad (◀) to move the cursor here then press any numeric key.

5. Move the cursor to [Enter] then press the **ENT** key. The message "Processing..." appears then the last-used screen appears.

Position offset

1. Press the **MENU ESC** key to open the main menu.
2. Select [6 Sensor Setting] then [1 Offset].
3. Select [4 Position Offset].

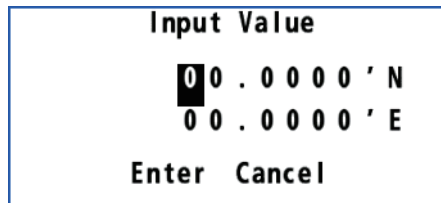

4. Enter the offset value with the numeric keys. To change the coordinate, select "N" or "E" then press one of keys from 0 to 9.
5. Move the cursor to [Enter] then press the **ENT** key.
6. Press the **MENU ESC** key to close the main menu.

Ship size and antenna position

1. Press the **MENU ESC** key to open the main menu.
2. Select [6 Sensor Setting] then [1 Offset].
3. Select [5 ShipSize•ANT/CALC-SPD POS].

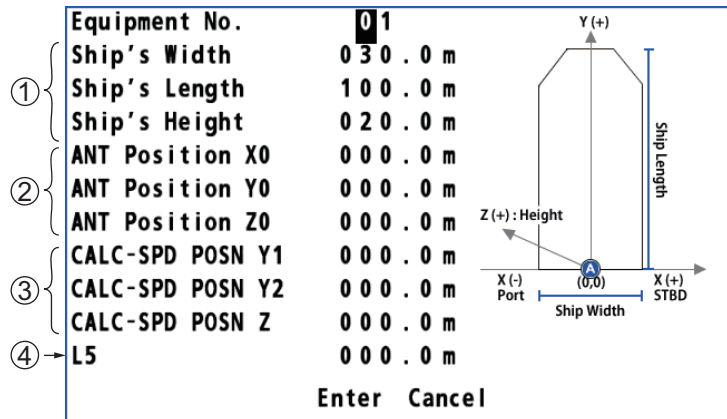

- ①: Set the width, length and height of your ship. Enter the values as correct as possible because these values influence the output sentence "POS". Note that these values are the upper limits for the values of ② and ③.
- ②: Set the mounting location for the antenna unit.
X0: The horizontal distance from the reference position "0" to the antenna position.
Y0: The forward distance from the reference position "0" to the antenna position.
Z0: The height from the ship bottom to the antenna unit GS-1001.
- ③: Set the correction of the mounting location for the antenna unit.
Y1, Y2: Ship's speed can be measured at two more positions in addition to the antenna position. Enter the forward distance from the reference position "0" to the position where you want to measure the ship's speed.
Note: Enter accurate positions for Y1 and Y2. If the positions are not set correctly, the speed indication may not be correct.
If the settings are not changed from the default "0", speed and ROT indications will not be correct. The setting for Y1 is used to calculate port and starboard speeds, as well as ROT. Therefore, to show speed indications as accurately as possible, set the Y1 value to the same as ship length.
Z: Enter "0" for the height from the transducer, the draft for the height from the draft.
- ④: Set the CCRP (Consistent Common Reference Point). Enter the forward distance from the reference position "0" to the CCRP. This information is used to draw the track based on the CCRP in the berthing display for the DS-600.

4. Enter the value for each item with the numeric keys. Refer to the figure at the right-hand of the display.

Note: The value for [ANT Position] is more accurate than the value for [CALC-SPD POSN].

5. Move the cursor to [Enter] then press the **ENT** key.
6. Press the **MENU ESC** key to close the main menu.

SOG offset

1. Press the **MENU ESC** key to open the main menu.
2. Select [6 Sensor Setting] then [1 Offset].
3. Select [6 SOG Offset].

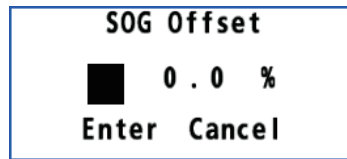

4. Enter the offset value with the numeric keys as follows:

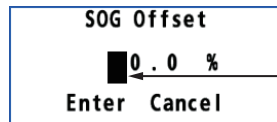

1) For example, to enter "+10.0%", press the cursorpad (▶) to move the cursor here.

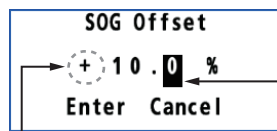

2) Press the 1, 0, 0 keys. When inputting positive number, "+" appears.

To switch between + and -, press the cursorpad (◀) to move the cursor here then press any numeric key.

5. Move the cursor to [Enter] then press the **ENT** key.
6. Press the **MENU ESC** key to close the main menu.

Atmospheric pressure or air temperature offset

1. Press the **MENU ESC** key to open the main menu.
2. Select [6 Sensor Setting] then [1 Offset].
3. Select [7 ATM Offset] or [8 TEMP Offset].

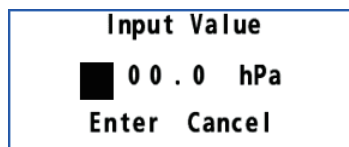

Atmospheric pressure

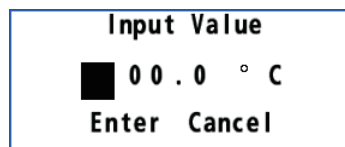

Air temperature

4. Enter the offset value with the numeric keys as follows:

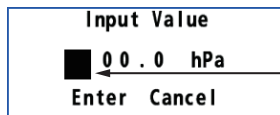

1) For example, to enter "+10.0", press the cursorpad (▶) to move the cursor here.

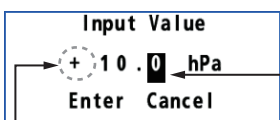

2) Press the 1, 0, 0 keys. When inputting positive number, "+" appears.

To switch between + and -, press the cursorpad (◀) to move the cursor here then press any numeric key.

5. Move the cursor to [Enter] then press the **ENT** key.
6. Press the **MENU ESC** key to close the main menu.

8.3.8 Alert mode

1. Press the **MENU ESC** key to open the main menu.
2. Select [3 Alert] then [2 Mode].

Note: This menu is for a serviceman.

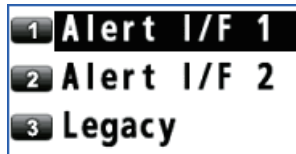

3. Select [1 Alert I/F 1], [2 Alert I/F 2] or [3 Legacy]. For [1 Alert I/F 1] or [2 Alert I/F 2], go to step 6. For [3 Legacy], go to step 4.
 - [Alert I/F 1]: This system is connected to a device that outputs the ALR sentence.
 - [Alert I/F 2]: This system is connected to a bridge alarm system.
 - [Legacy]: This system is connected to the IF-2503. Set the baud rate to 4800 bps. (See subsection 3.8.1.)
4. Select [3 Remote Ack I/F].



5. Select [1 Ack] or [2 Buzzer Stop].
 - [Ack]: Acknowledge an alert and stop the buzzer.
 - [Buzzer Stop]: Stop the buzzer.
6. Press the **MENU ESC** key to close the main menu.

8.3.9 IP address

Note: This function is for a serviceman.

IP address for your equipment

1. Press the **MENU ESC** key to open the main menu.
2. Select [7 System Setting] then [2 Network].
3. Select [1 Ethernet].

IP Address	172.031.018.011
Subnet Mask	255.255.000.000
Default Gateway	172.031.001.001
Enter Cancel	

4. Enter the IP address for your equipment (setting range: 172.16.0.1 to 172.31.255.254), subnet mask and default gateway with the numeric keys.
5. Move the cursor to [Enter] then press the **ENT** key.

IP address for device receiving output sentences

1. Press the **MENU ESC** key to open the main menu.
2. Select [5 I/O] then [5 Ethernet].
3. Select [3 IP ADR/Port].

IP Address	239.192.000.004
Port	60004
Enter Cancel	

4. Enter the IP address (setting range: 239.192.0.1 to 239.192.0.64) and port with the numeric keys.
5. Move the cursor to [Enter] then press the **ENT** key.

8.4 Connections and Adjustments with Optional Interface Unit IF-2503

The optional Interface Unit IF-2503 can be connected to the Display Unit GS-1002 to interface a radar or chart plotter and alarm system.

Connect the IF-2503 to the DATA4 port of the Display Unit GS-1002. Fabricate the MJ-A7SPF0003-050C cable as with the MJ-A6SPF0003-050C. (See the Operator's Manual for IF-2503.) After the connection, set the following menus.

- Set [BPS] in the [Output 4] menu to [4800 bps]. (See subsection 3.8.1.)
- Set [Mode] in the [Alert] menu to [Legacy]. (See subsection 8.3.8.)

8.5 Installation, Adjustment of Optional Display Unit DS-600

The Display Unit GS-1002 can be connected with the optional DS-600.

8.5.1 Installation of the display unit DS-600

Mounting considerations

The display unit DS-600 can be installed on a desktop, on the underside of a table, or flush mounted in a panel. When you select a mounting location, keep in mind the following points:

- Locate the display unit away from exhaust pipes and vents.
- Select an installation location that is well ventilated.
- Locate the display unit where shock and vibration are minimal.
- Allow enough maintenance space at the sides and rear of the display unit and leave enough slack in cables to facilitate maintenance and servicing.
- Observe the compass safe distances (see page i) to prevent the interference to a magnetic compass.
- The nominal viewing distance for the display unit is 1 m. Select a suitable mounting location considering that distance.

Flush mount

See the outline drawing in the back of this manual. Before you fasten the display unit to the cutout, first connect the cable to the DATA1/DATA2 port of the display unit GS-1002. (See subsection 8.2.2.)

1. Make a cutout in the mounting location as shown in the illustration below.

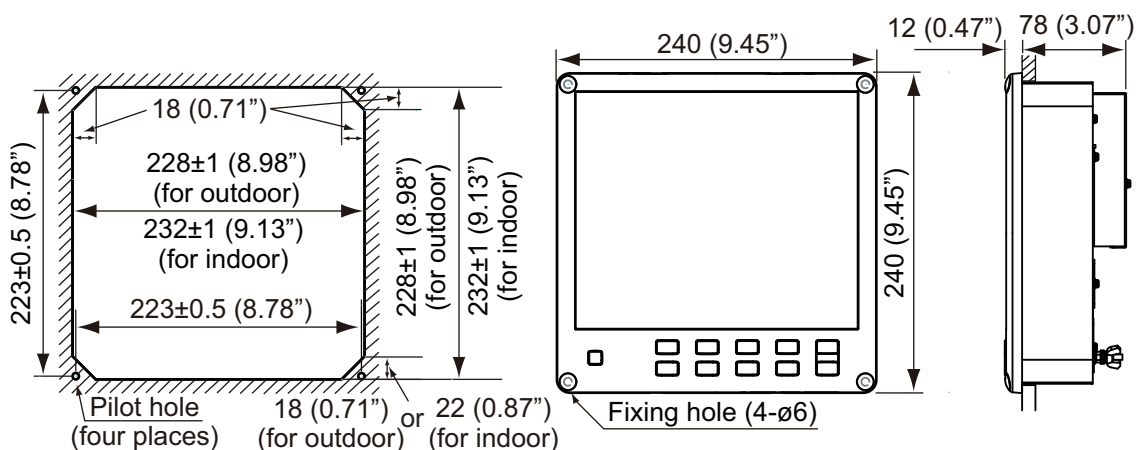

Note: Dimensions for the cutout are different depending on the mounting location, indoor or outdoor. For the outdoor mounting, ask dockyard to construct a water-proof case for the display unit.

2. Make four pilot holes for tapping screws (diameter: 5 mm) in the location indicated in the illustration at step 1.
3. Insert the sponge to the display unit from the rear side.
4. Set the display unit to the cutout and fasten the display unit with four tapping screws (5×20).

8. INSTALLATION

- Set a cosmetic cap to each fixing hole on the front panel. See "How to set the cosmetic caps and alarm lid assembly" on page 8-27.

Desktop or table underside mount

The display unit can be mounted on a desktop or on the underside of a table using the optional bracket. See the outline drawing for details.

Bracket Assembly with Knobs (Type: OP26-8, Code No.: 000-016-313)

Name	Type	Code No.	Qty
Tapping screw	5×20 SUS304	000-171-997-10	4
Binding head screw	M5×12 SUS304	000-171-999-10	4
Bracket assembly	OP26-8-1	001-081-920	1

- Remove the hanger fixing plates from the hanger assembly.
- Fasten the hanger fixing plates to the display unit from the left side and right side with four binding head screws (M5×12).
- Make four pilot holes for tapping screws (5×20) in the mounting location.
- Fix the hanger to the mounting location with four tapping screws (5×20).
- Screw knobs into the display unit loosely.
- Set the display unit to the hanger.
- Tighten the knobs to fasten the hanger to the display unit.
- Set a cosmetic cap to each fixing hole on the front panel.

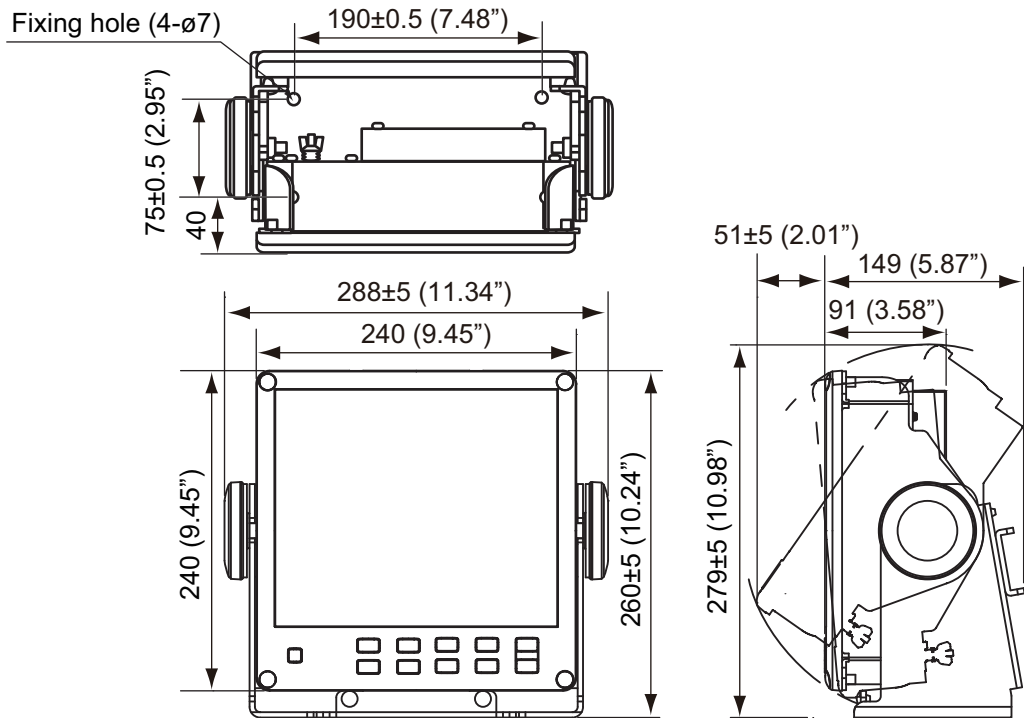
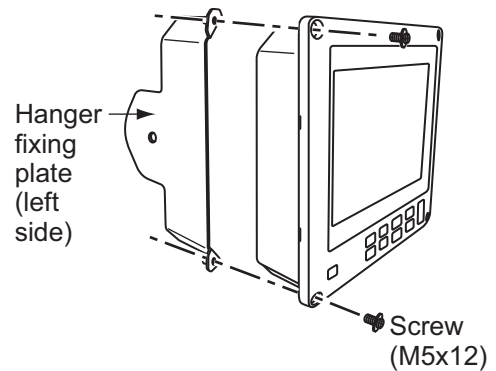

How to set the cosmetic caps and alarm lid assembly

Set a cosmetic cap to each fixing hole on the front panel as shown in the illustration below.

For the display unit to be used as a sub display, attach the alarm lid (supplied as accessories) to the **ALARM ACK** key to prevent accidental operation of the key.

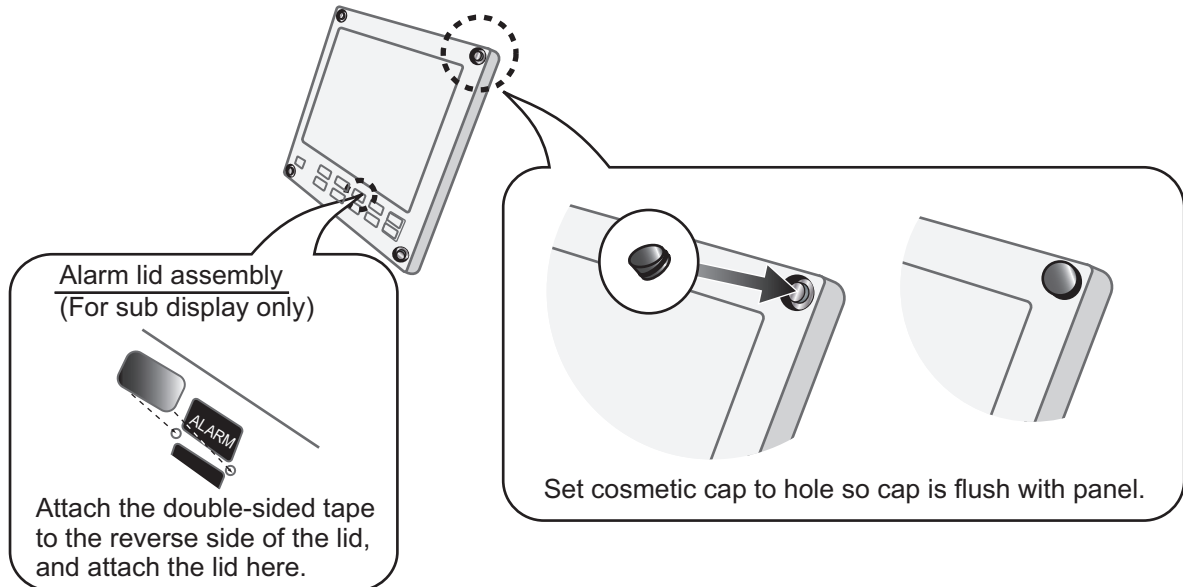

8.5.2 Menu settings for DS-600

Set up for use with the DS-600 from the Service menu.

How to use the Service menu

1. Press the **PWR** key while pressing the **DISP** key to turn the power on.
Note: Press and hold the keys until two beeps sound.
 The start-up screen appears for 90 seconds then the service menu appears.

Operation	: Main
Alarm Mode	: Alert I/F 1
Buzzer Stop	: Disable
I/O Port	
Output Data Format	: IEC61162-2 Ed.1
Input Data Format	: IEC
IEC61162 IN Monitor	
SIO Monitor	
Setting Ship's Data	
Ship's Name	: 000000000
IMO	: 000000000
Reference Point	: Center
Alarm Buzzer	: ON
Alarm Hysteresis	: 0.0kn
L/L digit	: 4digit
Used Time	
[▲/▼]: Select	
[ENT]: Enter	

2. Use ▲ or ▼ to select a menu item then press the **ENT** key to show the setting window.
3. Use ▲ or ▼ to change the setting then press the **ENT** key. To return to the menu, press the **MENU ESC** key.

8. INSTALLATION

4. Repeat steps 2 and 3 to complete the setting. For items to be set at the installation, see the table at the top of the next page.
5. Press the **PWR** key to turn the power off.

Menu item	Meaning	Option (bold: default)
[Operation]	Select [Main] or [Sub]. (For the display unit connected to the GS-1002, select [Sub].)	[Main] , [Sub], [Satellite]* *: Sub display shared between the GS-100 and the DS-60
[SIO Monitor]	Monitor the serial signal input to the display units (main and sub).	
[L/L digit]	Set the number of digits to show for the minutes indication in latitude and longitude position.	[3digit], [4digit]
Others	For the serviceman. No use in installation.	

How to set the displays

The DS-600 is preset with five displays as below:

- DISP1: Navigation data
- DISP2: Berthing (Head-up)
- DISP3: Heading and speed
- DISP4: Trip distance and total distance
- DISP5: Speed analog data (sub display only)

Only two berthing displays (for head-up and north-up) are available on the display unit DS-600 connected to the GS-1002. Set the displays as follows:

1. Press the **MENU ESC** key to open the menu.
2. Select [Display] then press the **ENT** key.

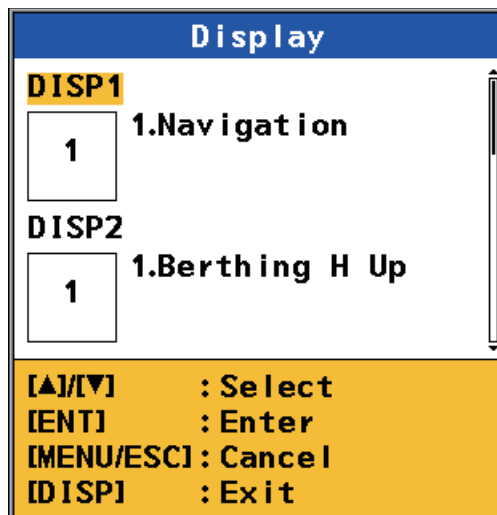

3. Select [DISP1] or [DISP2] then press the **ENT** key.

Full screen →

Two-way horizontal split screen →

Blank (no display)* →

Split Display

[▲]/[▼] : Select
 [ENT] : Enter
 [MENU/ESC] : Cancel
 [DISP] : Exit

*: Not available with DISP1.

4. Select the full screen then press the **ENT** key.

Item

1

HDG/Speed 3 axis
 Speed 3 axis
 Speed 2 axis
 Speed 1 axis
 Speed Graphic
Navigation
 Berthing H Up
 Berthing N Up
 Trip DIST
 Total DIST

[▲]/[▼] : Select
 [ENT] : Enter
 [MENU/ESC] : Cancel
 [DISP] : Exit

5. Select the orientation of the berthing display, [Berthing H Up] or [Berthing N Up], then press the **ENT** key.
6. Set [DISP3] to [DISP7] as blank (no display), following steps 3 to 5.
7. Press the **DISP** key to close the menu.

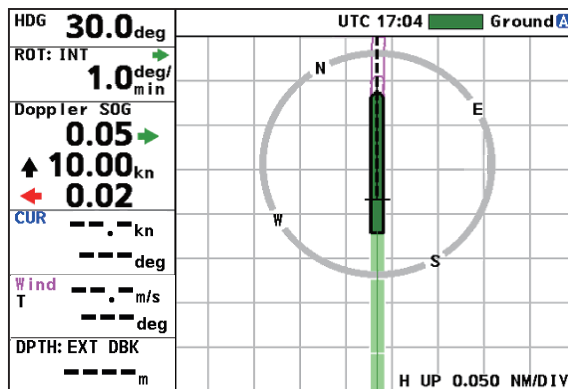

Berthing (Head-up)

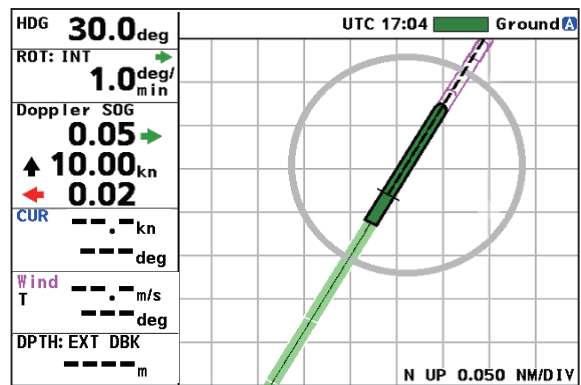

Berthing (North-up)

8.5.3 Adjustments for GS-1002

Set the following menus in the [Output Data1]/[Output Data2] menu (see subsection 3.8.1).

- [Format]: Select [IEC61162-1 Ed.4] or [IEC61162-1 Ed.3].
- [BPS]: Select [38400 bps].
- [Sentence]: Select the following sentences.
 - GGA*, VBW, VTG, ZDA: 1s (*: Have a serviceman set GGA.)
 - HDT, ROT: 0.1s

8.6 Speed Test

Note: This function is for a serviceman.

1. Press the **MENU ESC** key to open the main menu.
2. Select [2 Speed/Trip Setting] then [2 Trip].
3. Select [4 Speed Test]. The confirmation message appears.

Do you continue to do so?

1 Yes **2 No**

4. Select [1 Yes]. The sensor restarts then the following screen appears.

SDME			
FIX	PDOP	CALC STATE	COM. SAT
GN-3D	1.2	Normal	3
TRIP TIME			
TRIP DIST			
			NM
AVERAGE SPEED			
			k n

5. Press the **ENT** key. The GS-100 starts calculation of trip time, trip distance and average speed.

SDME			
FIX	PDOP	CALC STATE	COM. SAT
GN-3D	1.2	Normal	3
TRIP TIME			
10DAY 13:07'00.40			
TRIP DIST			
			13.92 NM
AVERAGE SPEED			
			8.25 k n
ENT Change Graphic Display DISPLAY THD Display			

APPENDIX 1 MENU TREE

GS-100

Bold Italic : Default

1 Display

- Background Color (***White*** , Black)
- Navigation Display
 - Window1 (***Roll/Pitch*** , SDME, Blank)
 - Window2 (***Position*** , Current, Blank)
 - Window3 (***Time&Date*** , Wind, Atm&Temp, Blank)
 - Window4 (***Heave*** , Depth, Blank)
 - Window5 (***Trip Time*** , Drift, Blank)
- Smoothing
 - SOG/COG (***0000*** s to 9999 s)
 - L/L (***0000*** s to 9999 s)
 - 3Axis Speed (0000 s to 9999 s, ***0020*** s)
 - Wind (***0000*** s to 9999 s)
 - ROT (00 s to 99 s, ***20*** s)
- Current/Wind
 - Current (***Flow to*** , Flow from)
 - Wind Speed (True, ***Theoretical*** , Relative)

2 Speed/Trip Setting

- Ship Speed (Off, In, ***Out*** , Speed)
- Trip
 - Calculation (Stop, ***Start/Restart*** , Clear)
 - Range (Open the setting window.)
 - Notice (***Off*** , On)
 - Speed Test* *: For serviceman.
- Total Distance
 - Clear
 - Preset (Open the setting window.)
- Sound
 - Notice Sound (***Off*** , On, Continuous)
 - Key Sound (***On*** , Off)

3 Alert

- Active Alert (Open the active alert list.)
- Mode* (Alert I/F 1, ***Alert I/F 2*** , Legacy)
- Remote Ack I/F (***Ack*** , Buzzer Stop)
- Alert Log (Open the alert log.)

4 Maintenance

- Information
 - Display Unit
 - Main board (Open the information for main board.)
 - Panel board (Open the information for panel board.)
 - CAN board (Open the information for CAN board.)
 - Antenna Unit
 - Main board (Open the information for main board.)
 - GNSS (Open the information for GNSS.)
 - Sensor (Open the information for sensor.)
- Self Test
 - Memory
 - Keyboard Test
 - Test Pattern
 - Automatic Test
 - Sound Test*

①

APPENDIX 1 MENU TREE

- ①
 - Backup
 - Backup User Setting (Yes, **No**)
 - Load User Setting (Yes, **No**)
 - SW/Database Update*
 - Chk the Available Software
 - Display Unit: Application
 - Display Unit: Boot
 - Antenna Unit: Application
 - Antenna Unit: GNSS
 - Antenna Unit: OS
 - Chk the New Data Table
 - Datum
 - WMM
 - Exchange*
 - Display Unit
 - LCD (Yes, **No**)
 - Main (Yes, **No**)
 - Antenna Unit
 - Main (Yes, **No**)
 - OMG (Open the setting window.)
 - ACC (Open the setting window.)
 - ATM (Open the setting window.)
 - TEMP (Open the setting window.)
 - Serial No. (Open the entry window.)
 - Destination Language (**English**, 日本語)
 - Sensor Status* (Open the sensor status window.)
 - Service*
 - Legacy Sentence Input (**Disable**, Enable)
 - VTG Speed Source (**Sensor Raw**, Corrected)
 - VBW Speed Source (Sensor Raw, **Corrected**)
 - Trip calc (**DS Mode**, GS Mode)
 - Device Mode (**SDME**, THD)

*: For serviceman.

5 I/O

- Output Data1 to 4
 - Format* (**IEC61162-1 Ed.4**, IEC61162-1 Ed.3, NMEA V2.0, NMEA V1.5, IEC61162-1 Ed.5)
 - BPS* (4800 bps, 38400 bps)**
 - **: Default (Output Data1 to 3: 4800 bps, Output Data4: 38400 bps)
 - Sentence (HDT: **Off**, HRM: **Off**, ROT: **Off**, THS: **0.2s*****, VBW: **1s**, VLW: **1s**, VTG: **1s**, ZDA: **1s**, GPatt: **Off**, GPhve: **Off**, GPimu: **Off**)***: 0.020s for Output Data4.
- Ethernet
 - Sentence (HDT: **0.1s**, HRM: **0.1s**, ROT: **0.1s**, THS: **0.020s**, VBW: **1s**, VLW: **1s**, VTG: **1s**, ZDA: **1s**, GPatt: **0.020s**, GPhve: **0.020s**, GPimu: **Off**)
 - SFI* (Open the entry window.)
 - IP ADR/Port* (Open the entry window.)
- Data Source Select
 - HDG (Data1, Data2, Data4, Ethernet, **CAN**, User Priority)
 - Ext. STW/COG/SOG (**Data1**, Data2, Data4, Ethernet, User Priority)
 - Ext. CUR (**Data1**, Data2, Data4, Ethernet, User Priority)
 - Ext. DEPTH (**Data1**, Data2, Data4, Ethernet, User Priority)
 - Ext. Wind (**Data1**, Data2, Data4, Ethernet, User Priority)

①

- ①
- Line Monitor
 - Data1 (Open the line monitor for serial data1.)
 - Data2 (Open the line monitor for serial data2.)
 - Data3 (Open the line monitor for serial data3.)
 - Data4 (Open the line monitor for serial data4.)
 - Ethernet (Open the line monitor for Ethernet.)
 - CAN (Open the line monitor for CAN.)
 - GS-1001* (**No**, USB, UDP)
 - LAN Error Counter (Open the LAN error data list.)
- Number of digits after decimal point
 - VTG (**1**, **2**)
 - VBW (**1**, **2**)
 - HDG (**1**, **2**)
 - Roll, Pitch (**1**, **2**)
- Non-IMO Sentence Output* (Enable, **Disable**)

6 Sensor Setting

- Offset*
 - HDG Offset (Open the setting window.) *: For serviceman.
 - Pitch Offset (Open the setting window.)
 - Roll Offset (Open the setting window.)
 - Position Offset (Open the setting window.)
 - ShipSize·ANT/CALC-SPD POS (Open the setting window.)
 - SOG Offset (Open the setting window.)
 - ATM Offset (Open the setting window.)
 - TEMP Offset (Open the setting window.)
- GNSS
 - Method (**MULTI**)
 - Condition
 - Elevation Mask* (Open the setting window.)
 - Not used GPS (Open the setting window.)
 - Not used GLONASS (Open the setting window.)
 - Not used Galileo (Open the setting window.)
 - Not used QZSS (Open the setting window.)
 - Source**
- SBAS**
 - Mode (GNSS, **GNSS+SBAS**)
 - SBAS Search (**Auto**, Manual)
 - Not used Satellite
 - SBAS (Open the setting window.)
- Other
 - App Reset (Yes, **No**)
 - Clear Setting* (Yes, **No**)
 - Dead Reckoning Time (**1 min**, 2 min, 3 min, 4 min, 5 min)
 - HDG Output Restart Mode (Manual, **Auto**)
- Device List (Open the device list.)

7 System Setting

- System
 - Unit of Distance (**NM**, km, SM)
 - cm/sec Display (**Off**, On)
 - Unit of Depth (m, **ft**, fm)
 - Datum (**WGS84**, WGS72, PZ90, CK42, CK95, Other)
 - Local Time (**UTC**, Local (Open the setting window.))
 - Summer Time (On, **Off**)
 - Master Sensor* (**Auto**, Manual)
 - Password*** (Open the setting window.) ***: For user.

①

APPENDIX 1 MENU TREE

- ① Network
 - ├ Ethernet* (Open the setting window.)
 - ├ Equipment ID (Open the setting window.)
 - ├ SNTP Server (**On**, Off)
 - ├ Maintenance Port* (Enable, **Disable**)
 - └ RMS IP ADR/Port* (Open the entry window.)
- Demo
 - ├ Moving Setting (Open the setting window.)
 - ├ Attitude Setting (Open the setting window.)
 - ├ Output Status* (**Simulation**, Fix, Differential Fix, Estimation(DR), Manual Input, No Fix)
 - └ Demo Start
- Berthing Line
 - ├ List (Open the berthing line list.)
 - └ Share (Send the berthing line data to DS-600.)
- Language/言語 (**English**, 日本語)
- Clear Memory
 - ├ Clear Display Setting (Yes, **No**)
 - ├ Clear GNSS* (Yes, **No**)
 - ├ Clear All* (Yes, **No**)
 - ├ Clear Ethernet Setting* (Yes, **No**)
 - └ Factory Default* (Yes, **No**)

DS-600 (The menus available on the sub display)

MENU ESC key

- ├ Ship's Time
 - ├ Source (Internal (-13:00 - + 13:00), **NAV EQUIP**)
 - └ Summer Time (ON, **OFF**)
- ├ Ship's Track (**Past+Predict**, Past, Predict, OFF)
- ├ Plot Time (1min, 2min, **5min**, 10min, 20min, 30min)
- ├ Past Tracks (**ON**, OFF)
- ├ Vector Time (30s, 1min, 2min, **5min**, 10min, 20min)
- ├ Display (DISP1, DISP2)
- ├ Scale Set Up
 - ├ Speed Graphic (DISP1, DISP2)
 - ├ Astern SPD Scale (**5kn(2.5m/s, 10km/h)**, 10kn(5.0m/s, 20km/h), 15kn(7.5m/s, 30km/h), 20kn(10.0m/s, 40km/h), 25kn(12.5m/s, 50km/h), 30kn(15.0m/s, 60km/h), 35kn(17.5m/s, 70km/h), 40kn(20.0m/s, 80km/h), 45kn(22.5m/s, 90km/h), 50kn(25.0m/s, 100km/h))
 - └ Ahead SPD Scale (Same choices as above, **25kn(12.5m/s, 50km/h)**)
 - ├ Depth REF (**EXT DBK**, EXT DBT, INT DBT)
 - ├ Direction SYM (**Arrows**, Text)
 - ├ SYM Location (**Left**, Right)
 - ├ Berthing Range (**50m(0.025NM)**, **75m(0.040NM)**, **100m(0.050NM)**, **150m(0.075NM)**, **200m(0.100NM)**, 250m(0.125NM), 300m(0.150NM), 400m(0.200NM), 600m(0.300NM), 800m(0.400NM), 1000m(0.500NM), Save)
 - ├ Berthing Data Display (**3 axis in NAV**, 3 axis and NAV, 3 axis)
 - ├ CUR Direction (**Flow to**, Flow from)
 - └ Mode
 - ├ Wind (**True**, Theoretical, Relative, OFF)
 - └ Time (**UTC**, Ship's Time)
- ├ Initialize
- ├ Wind Average (No Averaging, **1min**, 2min, 3min, 5min, 10min)
- ├ Key Beep (**ON**, OFF)
- ├ Key BRILL (1, **2**, 3, 4, 5, 6, 7, 8)
- ├ Speed Select (**Forward-After**, Vector)
- ├ TESTS (System TEST, Display Unit TEST, LCD TEST)
- └ User RESET (Yes, **No**)

APPENDIX 2 LIST OF TERMS/SYMBOLS

The following table shows the terms and symbols used in the GS-100.

Terms

Terms	Meaning
ACC	Accelerometer
ACK	Acknowledge
ADJ	Adjust, Adjustment
ADR	Address
ALARM	Alarm
ALT	Altitude
ANGLE	Angle
ANT	Antenna
APR	April
ATM	Atmosphere
ATTITUDE	Attitude
AUG	August
AUTO	Automatic
AVERAGE	Average
BARO	Barometer
BKGND	Background
BPS	Bit Per Second
BRILL	Brilliance
BS	Backspace
CAL	Calibrate
CALC	Calculation
CAN	Controller Area Network
CCRP	Consistent Common Reference Point
CCRS	Consistent Common Reference System
CLR	Clear
CNCL	Cancel
COG	Course Over the Ground
COM	Common
CONT	Contrast
CORR	Correction
CPU	Central Processing Unit
CURRENT, CUR	Current
DATE	Date
DAY	Day
DEC	December
DEL	Delete
DELAY	Delay
DEPTH	Depth
DGLONASS	Differential GLONASS
DGNSS	Differential GNSS

APPENDIX 2 LIST OF TERMS/SYMBOLS



















Terms	Meaning
DGPS	Differential GPS
DISP	Display
DIST	Distance
DOP	Dilution Of Precision
DOPPLER	Doppler
DR	Dead Reckoning, Dead Reckoned Position
DRIFT	Drift
DRMS	Distance Root Mean Square
DTM	Datum
E	East
EGNOS	European Geo-Stationary Navigational Overlay System
ENT	Enter
ERR	Error
ESC	Escape
EXT	External
FEB	February
FIX	Fix
FREQ	Frequency
FULL	Full
FWD	Foreword, Forward
GLONASS	Global Orbiting Navigation Satellite System
GND	Ground
GNSS	Global Navigation Satellite System
GPS	Global Positioning System
GYRO	Gyro
HDG	Heading
HDOP	Horizontal Dilution Of Precision
HEAVE	Heave
HSC	High Speed Craft
ID	Identification
I/O	Input/Output
IP	Internet Protocol
JAN	January
JUL	July
JUN	June
LAN	Local Area Network
LAT	Latitude
LCD	Liquid Crystal Display
LEN	Load Equivalency Number
LIST	List
L/L	Latitude and Longitude
LOG	Log
LON	Longitude
MAG	Magnetic
MAN	Manual
MAR	March
MAY	May
MENU	Menu
MIN	Minimum

Terms	Meaning
MAX	Maximum
MSTR	Master
N	North
NAV	Navigation
NM	Nautical Mile
NORM	Normal
NOV	November
NT	Night
OCT	October
OFF	Off
OFFSET	Offset
OMG	Omega
ON	On
ONF	Other Network Function Block
OS	Operating System
PCB	Printed Circuit Board
PDOP	Positional Dilution Of Precision
PITCH	Pitch
PORT	Port/Portside
POSITION, POSN, POS	Position
PRN	Pseudo-Random-Noise
PWR	Power
QZSS	Quasi-Zenith Satellite System
R	Relative Wind
RAIM	Receiver Autonomous Integrity Monitoring
REF	Reference
REL	Relative
RM	Relative Motion
RMS	Root Mean Square
RMS	Remote Maintenance System
ROLL	Roll
ROT	Rate Of Turn
Rx, RX	Receive
S	South
SATELLITE, SAT	Satellite
SBAS	Satellite Base Argument System
SDME	Speed and Distance Measuring Equipment
SEP	September
SFI	System Function ID
SIM	Simulation
SLAVE	Slave
S/N	Signal/Noise
SNTP	Simple Network Time Protocol
SNR	Signal to Noise Ratio
SOG	Speed Over the Ground
SPEED, SPD	Speed
STATE	State
STBD	Starboard/Starboard Side

APPENDIX 2 LIST OF TERMS/SYMBOLS

Terms	Meaning
STW	Speed Through the Water
SV	Space Vehicle
SW	Software
SYS	System
T	True
TAG	Tag
TCVR	Transceiver
TEMP	Temperature
TH	Theoretical Wind
THD	Transmitting Heading Device
TIME	Ship's Time, Time
TOTAL	Total
TRIP	Trip
TX	Transmit
TXRX	Transmit and Receive
UDP	User Datagram Protocol
UTC	Coordinated Universal Time, Universal Time Coordinated
W	West
WARNING	Warning
WGS	World Geodetic System
WMM	World Magnetic Model

Symbols

Symbols	Meaning
	Active unacknowledged warning
	Active acknowledged warning
	Active responsibility transferred warning (See section 5.5.)
	Rectified unacknowledged warning
	Silenced warning
	Background warning
	Background caution
	Caution
	Ship speed notice (See section 4.2.)
	Trip notice (See section 4.3.)
	There is no GS-1001 in CAN network but SC-30 is.
	There is no GS-1001B in CAN network but SC-33 is.
	The antenna acceleration is over 5 G.
	Satellite blocked. The common satellite for antenna 1 and 2 is blocked.
	Ready to output speed signal (See subsection 3.6.4.)
	Ready to output heading signal (See subsection 3.6.4.)
	High precision speed computing
	Apply to Multi-GNSS (GPS, GLONASS, Galileo and QZSS).
	Demo mode

APPENDIX 3 TIME DIFFERENCES

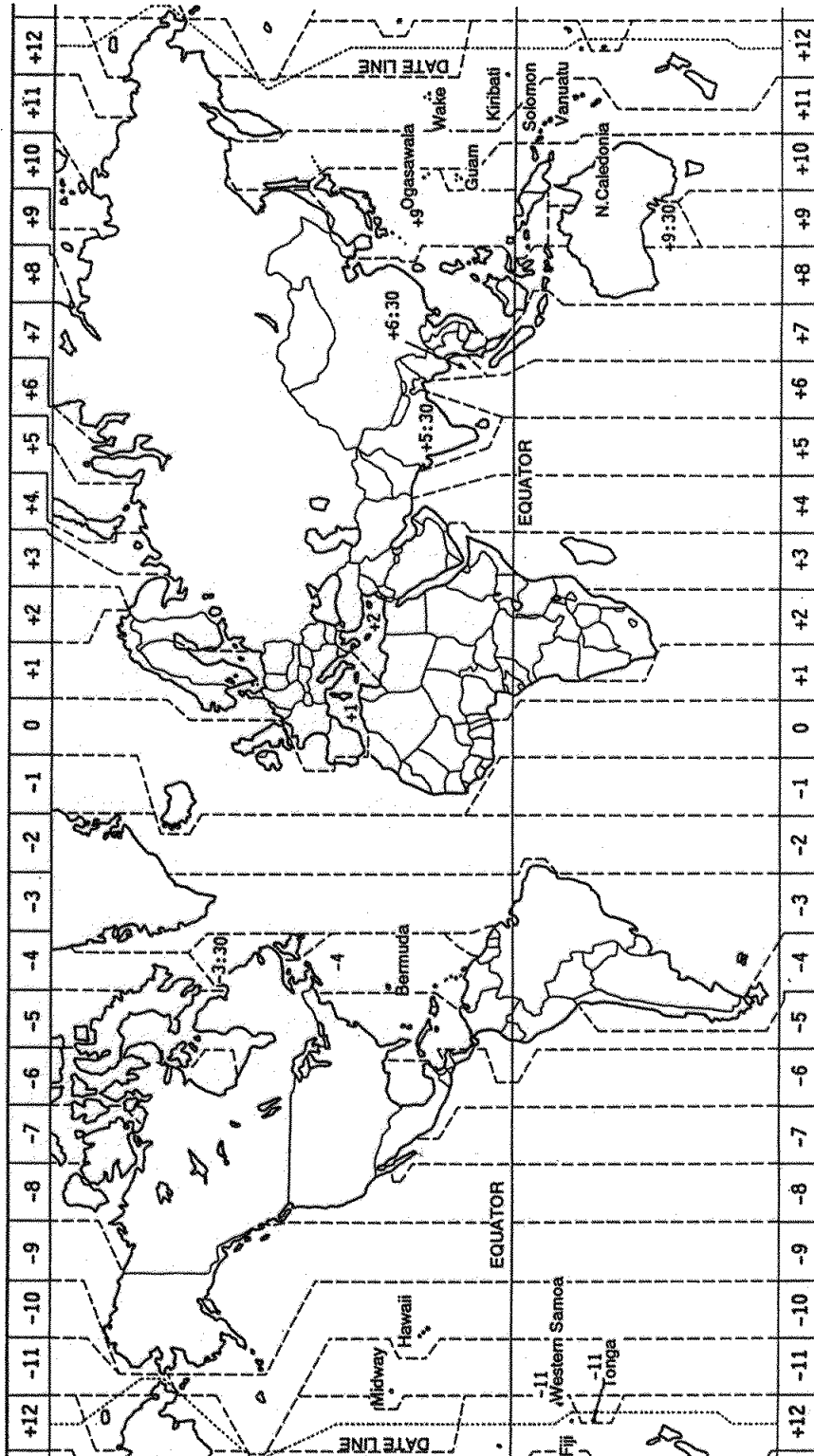

APPENDIX 4 GEODETIC CHART LIST

001: WGS84		
002: WGS72		
003: TOKYO	: Mean Value (Japan, Korea & Okinawa)	
004: NORTH AMERICAN 1927	: Mean Value (CONUS)	
005: EUROPEAN 1950	: Mean Value	
006: AUSTRALIAN GEODETIC 1984	: Australia & Tasmania	
007: ADINDAN	: Mean Value (Ethiopia & Sudan)	
008: ADINDAN	: Ethiopia	
009: ADINDAN	: Mali	
010: ADINDAN	: Senegal	
011: ADINDAN	: Sudan	
012: AFG	: Somalia	
013: AIN EL ABD 1970	: Bahrain Is.	
014: ANNA 1 ASTRO 1965	: Cocos Is.	
015: ARC 1950	: Mean Value	
016: ARC 1950	: Botswana	
017: ARC 1950	: Lesotho	
018: ARC 1950	: Malawi	
019: ARC 1950	: Swaziland	
020: ARC 1950	: Zaire	
021: ARC 1950	: Zambia	
022: ARC 1950	: Zimbabwe	
023: ARC 1960	: Mean Value (Kenya & Tanzania)	
024: ARC 1960	: Kenya	
025: ARC 1960	: Tanzania	
026: ASCENSION IS. 1958	: Ascension Is.	
027: ASTRO BEACON "E"	: Iwo Jima Is.	
028: ASTRO B4 SOR. ATOLL	: Tern Is.	
029: ASTRO POS 71/4	: St. Helena Is.	
030: ASTRONOMIC STATION 1952	: Marcus Is.	
031: AUSTRALIAN GEODETIC 1966	: Australia & Tasmania	
032: BELLEVUE (IGN)	: Efate & Erromango Is.	
033: BERMUDA 1957	: Bermuda Is.	
034: BOGOTA OBSERVATORY	: Columbia	
035: CAMPO INCHAUSPE	: Argentina	
036: CANTON IS. 1966	: Phoenix Is.	
037: CAPE	: South Africa	
038: CAPE CANAVERAL	: Mean Value (Florida & Bahama Is.)	
039: CARTHAGE	: Tunisia	
040: CHATHAM 1971	: Chatham Is. (New Zealand)	
041: CHUA ASTRO	: Paraguay	
042: CORREGO ALEGRE	: Brazil	
043: DJAKARTA (BATAVIA)	: Sumatra Is. (Indonesia)	
044: DOS 1968	: Gizo Is. (New Georgia Is.)	
045: EASTER IS. 1967	: Easter Is.	
046: EUROPEAN 1950 (Cont'd)	: Western Europe	
047: EUROPEAN 1950 (Cont'd)	: Cyprus	
048: EUROPEAN 1950 (Cont'd)	: Egypt	
049: EUROPEAN 1950 (Cont'd)	: England, Scotland, Channel & Shetland Is.	
050: EUROPEAN 1950 (Cont'd)	: England, Ireland, Scotland & Shetland Is.	
051: EUROPEAN 1950 (Cont'd)	: Greece	
052: EUROPEAN 1950 (Cont'd)	: Iran	
053: EUROPEAN 1950 (Cont'd)	: Italy, Sardinia	
054: EUROPEAN 1950 (Cont'd)	: Italy, Sicily	
055: EUROPEAN 1950 (Cont'd)	: Norway & Finland	
056: EUROPEAN 1950 (Cont'd)	: Portugal & Spain	
057: EUROPEAN 1979	: Mean Value	
058: GANDAJIKA BASE	: Republic of Maldives	
059: GEODETIC DATUM 1949	: New Zealand	
060: GUAM 1963	: Guam Is.	
061: GUX 1 ASTRO	: Guadalcanal Is.	
062: HJORSEY 1955	: Iceland	
063: HONG KONG 1963	: Hong Kong	
064: INDIAN	: Thailand & Vietnam	
065: INDIAN	: Bangladesh, India & Nepal	
066: IRELAND 1965	: Ireland	
067: ISTS 073 ASTRO 1969	: Diego Garcia	
068: JOHNSTON IS. 1961	: Johnston Is.	
069: KANDAWALA	: Sri Lanka	
070: KERGUULEN IS.	: Kerguelen Is.	
071: KERTAUI 1948	: West Malaysia & Singapore	
072: LA REUNION	: Mascarene Is.	
073: L. C. 5 ASTRO	: Cayman Brac Is.	
074: LIBERIA 1964	: Liberia	
075: LUZON	: Philippines (excl. Mindanao Is.)	
076: LUZON	: Mindanao Is.	
077: MAHE 1971	: Mahe Is.	
078: MARCO ASTRO	: Salvage Islands	
079: MASSAWA	: Eritrea (Ethiopia)	
080: MERCHICH	: Morocco	
081: MIDWAY ASTRO 1961	: Midway Is.	
082: MINNA	: Nigeria	
083: NAHRWAN	: Masirah Is. (Oman)	
084: NAHRWAN	: United Arab Emirates	
085: NAHRWAN	: Saudi Arabia	
086: NAMIBIA	: Namibia	
087: MAPARIMA, BWI	: Trinidad & Tobago	
088: NORTH AMERICAN 1927	: Western United States	
089: NORTH AMERICAN 1927	: Eastern United States	
090: NORTH AMERICAN 1927	: Alaska	
091: NORTH AMERICAN 1927	: Bahamas (excl. San Salvador Is.)	
092: NORTH AMERICAN 1927	: Bahamas, San Salvador Is.	
093: NORTH AMERICAN 1927 (Cont'd)	: Canada (incl. Newfoundland Is.)	
094: NORTH AMERICAN 1927 (Cont'd)	: Alberta & British Columbia	
095: NORTH AMERICAN 1927 (Cont'd)	: East Canada	
096: NORTH AMERICAN 1927 (Cont'd)	: Manitoba & Ontario	
097: NORTH AMERICAN 1927 (Cont'd)	: Northwest Territories & Saskatchewan	
098: NORTH AMERICAN 1927 (Cont'd)	: Yukon	
099: NORTH AMERICAN 1927 (Cont'd)	: Canal Zone	
100: NORTH AMERICAN 1927 (Cont'd)	: Caribbean	
101: NORTH AMERICAN 1927 (Cont'd)	: Central America	
102: NORTH AMERICAN 1927 (Cont'd)	: Cuba	
103: NORTH AMERICAN 1927 (Cont'd)	: Greenland	
104: NORTH AMERICAN 1927 (Cont'd)	: Mexico	
105: NORTH AMERICAN 1983	: Alaska	
106: NORTH AMERICAN 1983	: Canada	
107: NORTH AMERICAN 1983	: CONUS	
108: NORTH AMERICAN 1983	: Mexico, Central America	
109: OBSERVATORIO 1966	: Corvo & Flores Is. (Azores)	
110: OLD EGYPTIAN 1930	: Egypt	
111: OLD HAWAIIAN	: Mean Value	
112: OLD HAWAIIAN	: Hawaii	
113: OLD HAWAIIAN	: Kauai	
114: OLD HAWAIIAN	: Maui	
115: OLD HAWAIIAN	: Oahu	
116: OMAN	: Oman	
117: ORDNANCE SURVEY OF GREAT BRITAIN 1936	: Mean Value	
118: ORDNANCE SURVEY OF GREAT BRITAIN 1936	: England	
119: ORDNANCE SURVEY OF GREAT BRITAIN 1936	: England, Isle of Man & Wales	
120: ORDNANCE SURVEY OF GREAT BRITAIN 1936	: Scotland & Shetland Is.	
121: ORDNANCE SURVEY OF GREAT BRITAIN 1936	: Wales	
122: PICO DE LAS NIVIES	: Canary Is.	
123: PITCAIRN ASTRO 1967	: Pitcairn Is.	
124: PROVISIONAL SOUTH CHILEAN 1963	: South Chile (near 53°S)	
125: PROVISIONAL SOUTH AMERICAN 1956	: Mean Value	
126: PROVISIONAL SOUTH AMERICAN 1956	: Bolivia	
127: PROVISIONAL SOUTH AMERICAN 1956	: Chile-Northern Chile (near 19°S)	
128: PROVISIONAL SOUTH AMERICAN 1956	: Chile-Southern Chile (near 43°S)	
129: PROVISIONAL SOUTH AMERICAN 1956	: Columbia	
130: PROVISIONAL SOUTH AMERICAN 1956	: Ecuador	
131: PROVISIONAL SOUTH AMERICAN 1956	: Guyana	
132: PROVISIONAL SOUTH AMERICAN 1956	: Peru	
133: PROVISIONAL SOUTH AMERICAN 1956	: Venezuela	
134: PUERTO RICO	: Puerto Rico & Virgin Is.	
135: QATAR NATIONAL	: Qatar	
136: QORNOQ	: South Greenland	
137: ROME 1940	: Sardinia Is.	
138: SANTA BRAZ	: Sao Miguel, Santa Maria Is. (Azores)	
139: SANTO (DOS)	: Espirito Santo Is.	
140: SAPPER HILL 1943	: East Falkland Is.	
141: SOUTH AMERICAN 1969	: Mean Value	
142: SOUTH AMERICAN 1969	: Argentina	
143: SOUTH AMERICAN 1969	: Bolivia	
144: SOUTH AMERICAN 1969	: Brazil	
145: SOUTH AMERICAN 1969	: Chile	
146: SOUTH AMERICAN 1969	: Columbia	
147: SOUTH AMERICAN 1969	: Ecuador	
148: SOUTH AMERICAN 1969	: Guyana	
149: SOUTH AMERICAN 1969	: Paraguay	
150: SOUTH AMERICAN 1969	: Peru	
151: SOUTH AMERICAN 1969	: Trinidad & Tobago	
152: SOUTH AMERICAN 1969	: Venezuela	
153: SOUTH ASIA	: Singapore	
154: SOUTHEAST BASE	: Porto Santo & Madeira Is.	
155: SOUTHWEST BASE	: Faial, Graciosa, Pico, Sao Jorge & Terceira Is.	
156: TIMBALAI 1948	: Brunei & East Malaysia (Sarawak & Sabah)	
157: TOKYO	: Japan	
158: TOKYO	: Korea	
159: TOKYO	: Okinawa	
160: TRISTAN ASTRO 1968	: Tristan da Cunha	
161: VITI LEVU 1916	: Viti Levu Is. (Fiji Is.)	
162: WAKE-ENIWETOK 1960	: Marshall Is.	
163: ZANDERIJ	: Surinam	
164: BUKIT RIMPAH	: Bangka & Belitung Is. (Indonesia)	
165: CAMP AREA ASTRO	: Camp McMurdo Area, Antarctica	
166: G. SEGARA	: Kalimantan Is. (Indonesia)	
167: HERAT NORTH	: Afghanistan	
168: HU-TZU-SHAN	: Taiwan	
169: TANANARIVE OBSERVATORY 1925	: Madagascar	
170: YACARE	: Uruguay	
171: RT-90	: Sweden	
172: PULKOVO 1942	: Russia	
173: FINNISH KKJ	: Finland	

APPENDIX 5 WHAT IS SBAS?

A satellite based augmentation system, or SBAS (Satellite Based Augmentation System), is an augmentation system that uses additional messages from satellite broadcasts to support regional and wide area augmentation. SBAS provides GPS signal corrections to SBAS users, for even better position accuracy, through the GPS error corrections that are widely broadcasted from the geostationary satellite.

SBAS is used in America, Europe, Japan and India.

- America: WAAS (Wide Area Augmentation System)
- Europe: EGNOS (Euro Geostationary Navigation Overlay Service)
- Japan: MSAS (Multi-Functional Satellite Augmentation System)
- India: GAGAN (GPS And GEO Augmented Navigation)

These four systems have interoperability. The illustration below shows the coverage area for each provider. This manual uses "SBAS" for these four providers generically.

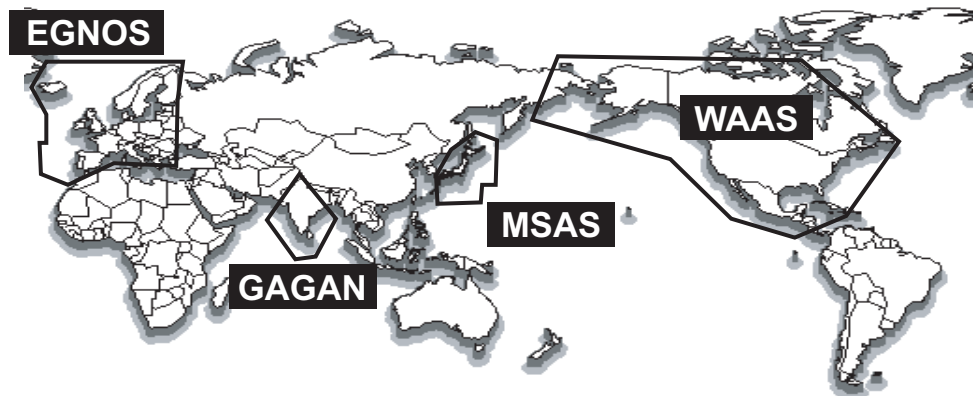

Provider	Satellite type	Longitude	Satellite No.
WAAS	Intelsat Galaxy XV	133°W	135
	TeleSat Anik F1R	107.3°W	138
	Inmarsat-4-F3	98°W	133
EGNOS	Inmarsat-3-F2/AOR-E	15.5°W	120
	Artemis	21.5°E	124
	Inmarsat-4-F2	25°E	126
	SES-5	5°E	136
MSAS	MTSAT-1R	140°E	129
	MTSAT-2	145°E	137
GAGAN	GSAT-8	55°E	127
	GSAT-10	83°E	128

As of March 6th, 2014

APPENDIX 6 DIGITAL INTERFACE (IEC61162-1/2/450)

Output sentences

DATA 1, DATA 2, DATA 3, DATA 4

ALC, ALF, ALR, ARC, HBT, HDT*, HRM, POS, ROT, THS, VBW, VLW, VTG, ZDA

Ethernet

ALC, ALF, ALR, ARC, HBT, HDT*, HRM, POS, ROT, THS, VBW, VLW, VTG, ZDA

*: Not used by SOLAS ships

Input sentences

DATA 1, DATA 2, DATA 4

ACK, ACM, ACN, CUR, DPT, HBT, HDG, HDT*, MWV, ROT, THS, VBW, VDR

Ethernet

ACK, ACM, ACN, CUR, DPT, HBT, HDG, HDT*, MWV, ROT, THS, VBW, VDR

*: Not used by SOLAS ships

FURUNO proprietary sentences

DATA 1, DATA 2, DATA 4 Input

PFEC (llals, pireq)

DATA 1, DATA 2, DATA 3, DATA 4 Output

PFEC (llalr, pidat, GPatt, GPhve, GPimu)

Ethernet Input

PFEC (pireq)

Ethernet Output

PFEC (pidat, rminf, GPatt, GPhve, GPimu)

Transmission interval

All sentences except ALR and HBT output at the interval selected (00 - 90 s).

Load requirements as listener

Isolation: Photo coupler

Input impedance: 470 ohms

Max. voltage: $\pm 15V$

Threshold: 3 mA (in case of connection of FURUNO device talker)

Data transmission

Data is transmitted in serial asynchronous form in accordance with the standard referenced in IEC 61162-1 and IEC 61162-2. The first bit is a start bit and is followed by data bits.

The following parameters are used:

Baud rate: 4800 for IEC61162-1, 38400 for IEC-61162-2

Data bits: 8 (D7 = 0), parity none

Stop bits: 1 datagram type and IGMP protocol.

IEC61162-1: Edition 5.0 2016, Edition 4.0 2010-11, Third edition 2007-04

IEC61162-2: First Edition 1998-09

IEC61162-450: Edition 2.0 2018-05, Datagram type: UdPbC

IGMP protocol: IGMPv2

Schematic diagrams

DATA 1, 2, or 3 port (output)

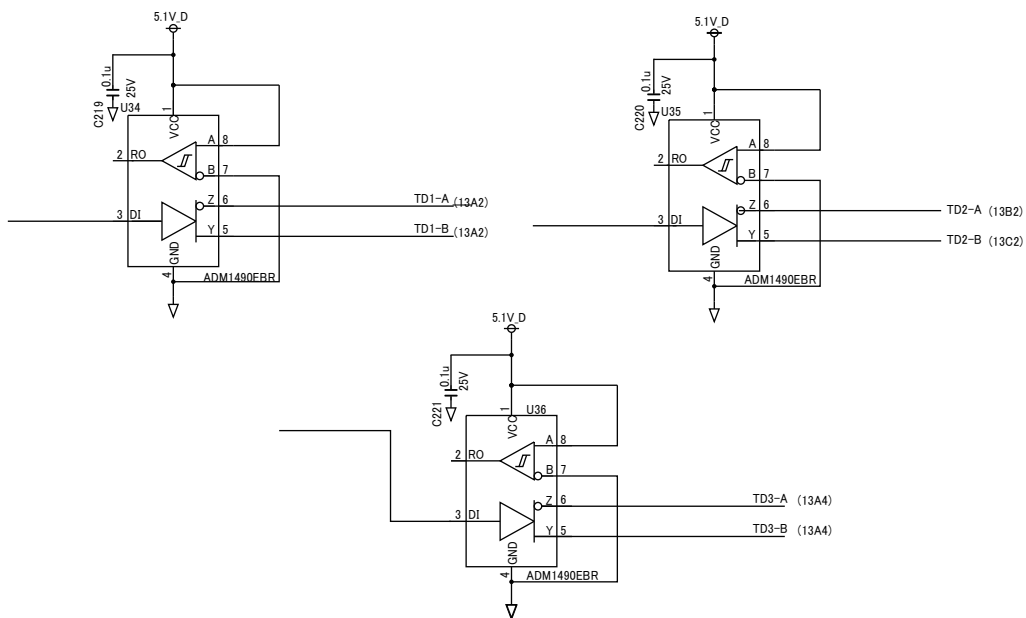

DATA 1 or 2 port (input)

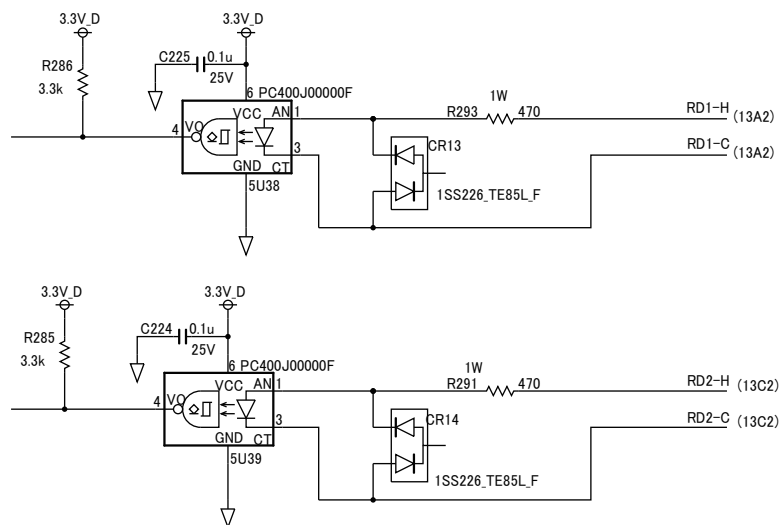

Ethernet

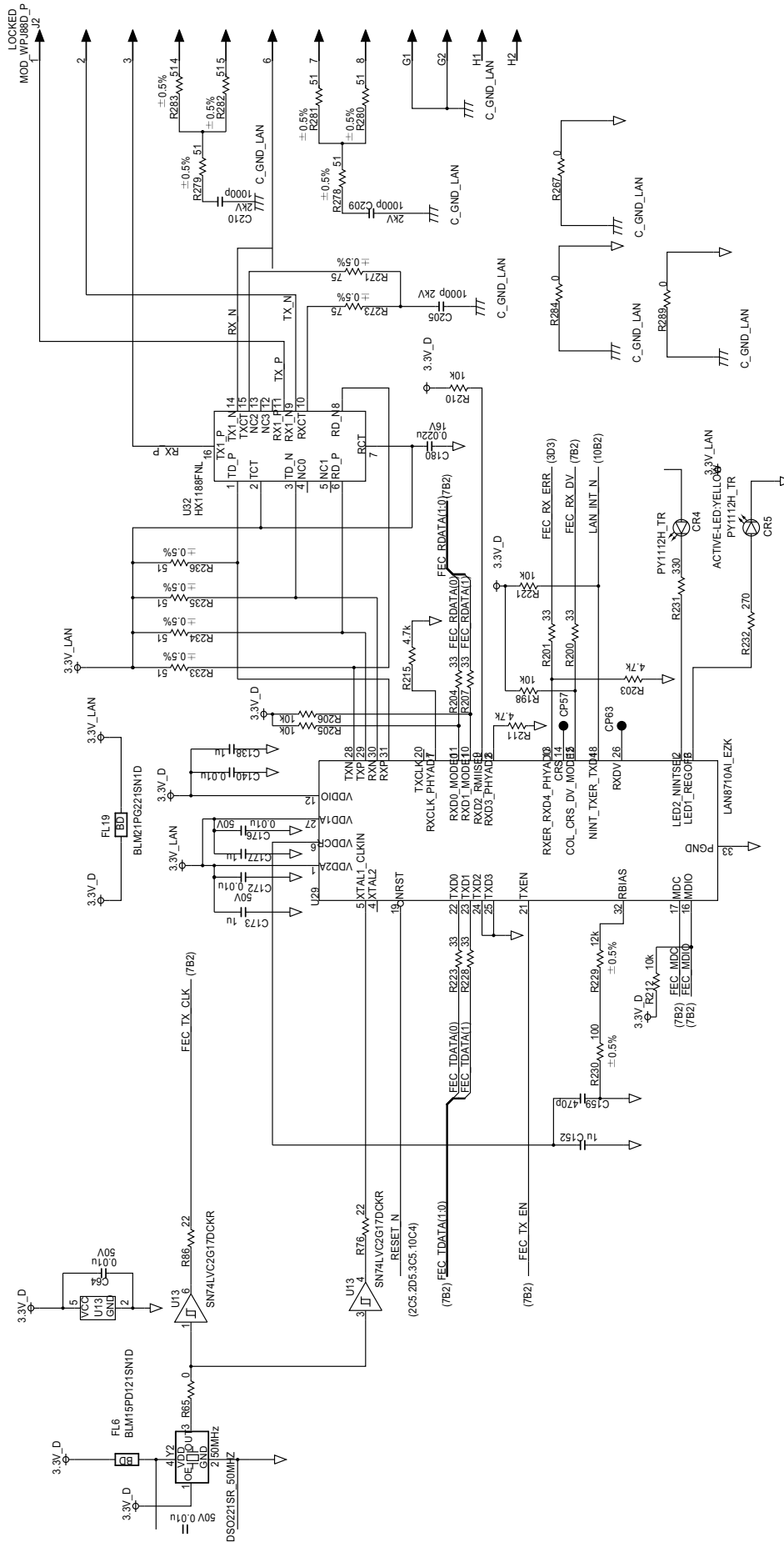

Note: For layout purposes and to prevent miswiring, the TX and RX lines on HX1188FNL are connected reversely of shown here. The TX and RX lines share the same transformer structure so there is no problem.

Sentence description

ACK-Acknowledge alarm

```
$**ACK,xxx,*hh<CR><LF>
```

1

1. Local alarm number (identifier)

ACM-Alert Command

```
$**ACM,hhmmss.ss,aaa,x.x,x.x,c,a*hh<CR><LF>
```

1 2 3 4 5 6

1. Time (hh=00 to 23, mm=00 to 59, ss.ss=00.00 to 59.99), null
2. Manufacturer mnemonic code (3 digit alphanumeric code), null
3. Alert identifier (000 to 999999)
4. Alert instance (1 to 999999), null
5. Alert command (A=ACK from ext. equipment, Q=Request from ext. equipment, O=Responsibility transfer, S=Silence from ext. equipment)
6. Sentence status flag (C should not be null field. Sentence without C is not a command.)

ACN-Alert command

```
$**ACN,hhmmss.ss,aaa,x.x,x.x,c,a*hh<CR><LF>
```

1 2 3 4 5 6

1. Time (hh=00 to 23, mm=00 to 59, ss.ss=00.00 to 59.99), null
2. Manufacturer mnemonic code (3 digit alphanumeric code), null
3. Alert identifier (000 to 999999)
4. Alert instance (1 to 999999), null
5. Alert command (A=ACK from ext. equipment, Q=Request from ext. equipment, O=Responsibility transfer, S=Silence from ext. equipment)
6. Sentence status flag (C should not be null field. Sentence without C is not a command.)

ALC-Cyclic alert list

```
$**ALC,xx,xx,xx,x.x,aaa,x.x,x.x,x.x,"",*hh<CR><LF>
```

1 2 3 4 5 6 7 8 9

1. Total number of sentences this message (01 to 99)
2. Sentence number (01 to 99)
3. Sequential message identifier (00 to 99)
4. Number of alert entries (0 to 2)
5. Manufacturer mnemonic code (FEC, null)
6. Alert identifier (000 to 999999)
7. Alert instance (1 to 999999)
8. Revision counter (1 to 99)
9. Additional alert entries (same as 5 and 8)

ALF-Alert sentence

\$**ALF,x,x,x,hmmss.ss,a,a,a,aaa,x,x,x,x,x,c--c,*hh<CR><LF>
 1 2 3 4 5 6 7 8 9 10 11 12 13

1. Total number of ALF sentences this message (1, 2)
2. Sentence number (1, 2)
3. Sequential message identifier (0 to 9)
4. Time of last change (hh=00 to 23, mm=00 to 59, ss.ss=00.00 to 60.99), null
5. Alert category (A=Alert category A, B=Alert category B, C=Alert category C), null when #2 is 2.
6. Alert priority (E=Emergency Alarm, A=Alarm, W=Warning, C=Caution), null when #2 is 2.
7. Alert state (V=Active – unacknowledged, S=Active – silenced, A=Active – acknowledged or active, O=Active – responsibility transferred, U=Rectified – unacknowledged, N=Normal), null when #2 is 2.
8. Manufacturer mnemonic code (FEC, null)
9. Alert identifier (000 to 999999)
10. Alert instance (1 to 999999)
11. Revision counter (1 to 99)
12. Escalation counter (0 to 9)
13. Alert text (max. 16 characters)

ALR-Set alarm state

\$**ALR,hmmss.ss,xxx,A,A,c—c,*hh<CR><LF>
 1 2 3 4 5

1. Time of alarm condition change, UTC
2. Unique alarm number (identifier) at alarm source
3. Alarm condition (A=threshold exceeded, V=not exceeded)
4. Alarm acknowledge state (A=acknowledged, V=not acknowledged)
5. Alarm description text (alphanumeric)

ARC-Alert command refused

\$**ARC,hmmss.ss,aaa,x,x,x,x,c*hh<CR><LF>
 1 2 3 4 5

1. Release time of the Alert Command Refused(UTC)
2. Used for proprietary alerts, defined by the manufacturer (FEC, null)
3. The alert identifier(000 to 999999)
4. The alert instance(1 to 999999)
5. Refused Alert Command(A, Q, O, S)
 A=acknowledge: A
 Q=request/repeat information
 O=responsibility transfer
 S=silence

CUR-Water current layer–Multi-layer water current data

\$**CUR,A,x,x,x,x,x,x,a,x,x,x,x,x,a,a,*hh<CR><LF>
 1 2 3 4 5 6 7 8 9 10 11

1. Validity of data (A=Valid, V=Not valid)
2. Data set number (0 to 9)
3. Layer number (1 to 3)
4. Current depth in meters (no use)
5. Current direction in degrees (0.00 to 360.00)
6. Direction reference in use (true or relative)
7. Current speed in knots (0.00 to 99.99)
8. Reference layer depth in meters (no use)
9. Heading (0 to 360.00)
10. Heading reference in use (true or magnetic)
11. Speed reference (B=Bottom track W=Water track P=Positioning system (no use)

DPT-Depth

\$**DPT,x.x,x.x,x.x,*hh<CR><LF>

1 2 3

1. Water depth relative to the transducer, meters
2. Offset from transducer, meters
3. Minimum range scale in use (no use)

HBT-Heartbeat supervision sentence

\$**HBT,x.x,A,x*hh<CR><LF>

1 2 3

1. Configured repeat interval (1 to 99(s))
2. Equipment status (A=Normal V=System fail)
3. Sequential sequence identifier (0 to 9)

HDG-Heading, deviation and variation

\$**HDG,x.x,x.x,a,x.x,a*hh<CR><LF>

1 2 3 4 5

1. Magnetic sensor heading, degrees
2. Magnetic deviation, degrees
3. E/W
4. Magnetic variation, degrees
5. E/W

HDT-Heading true (Not used by SOLAS ships)

\$**HDT,xxx.x,T*hh<CR><LF>

1 2

1. Heading, degrees
2. True (T)

HRM-Heel angle, roll period and roll amplitude measurement device

\$**HRM,x.x,x.x,x.x,x.x,A,x.x,x.x,hhmmss.ss,xx,xx*hh <CR><LF>

1 2 3 4 5 6 7 8 9 10

1. Actual heel angle, degrees
2. Roll period, seconds
3. Roll amplitude, port side, degrees
4. Roll amplitude, starboard side, degrees
5. Status
6. Roll peak hold value, port side, degrees
7. Roll peak hold value, starboard side, degrees
8. Peak hold value reset time
9. Peak hold value reset day, 01 to 31
10. Peak hold value reset month, 01 to 12

MWV-Wind speed and angle

\$**MWV,x.x,a,x.x,a,A*hh<CR><LF>

1 2 3 4 5

1. Wind angle, degrees (0.00 to 360.00)
2. Reference (R/T)
3. Wind speed (0.00 to 9999.99)
4. Wind speed units (K=km/h M=m/s N=nm)
5. Status (A=Valid V=Not valid)

POS-Device position and ship dimensions report or configuration command

\$**POS,cc,xx,a,x,x,x,x,x,a,x,x,x,a*hh<CR><LF>
1 2 3 4 5 6 7 8 9 10

1. Equipment ID (IEC 61162-1 Ed.5)
2. Equipment number
3. Position validity flag (A=valid V=invalid)
4. Position X-coordinate
5. Position Y-coordinate
6. Position Z-coordinate
7. Ship's width and length (A=valid V=invalid)
8. Ship's width
9. Ship's length
10. Sentence status flag (R=sentence is status report of current settings
C=sentence is a configuration command to change settings)

ROT-Rate of turn

\$**ROT,x.x,A*hh<CR><LF>
1 2

1. Rate of turn, deg/min, "-"=bow turns to port (-9999.9 to 9999.9)
2. Status: A=Data valid, V=Data invalid

THS-True heading and status

\$**THS,xxx.x,a*hh<CR><LF>
1 2

1. Heading, degrees True
2. Mode indicator (A=autonomous E=estimated M>manual input
S=simulator V=data not valid)

VBW-Dual ground/water speed

\$**VBW,x.x,x,x,x,x,x,x,x,x,x,x,x,x,*hh<CR><LF>
1 2 3 4 5 6 7 8 9 10

1. Longitudinal water speed, knots
2. Transverse water speed, knots
3. Status: water speed, A=data valid V=data invalid
4. Longitudinal ground speed, knots
5. Transverse ground speed, knots
6. Status: ground speed, A=data valid V=data invalid
7. Stern transverse water speed, knots
8. Status: stern water speed, A=data valid V=data invalid
9. Stern transverse ground speed, knots
10. Status: stern ground speed, A=data valid V=data invalid

VDR-Set and drift

\$**VDR,x.x,T,x.x,M,x.x,N*hh<CR><LF>
1 2 3 4 5 6

1. Direction, degrees
2. T=True (fixed)
3. Direction, degrees
4. M=Magnetic (fixed)
5. Current speed
6. N=Knots (fixed)

VLW-Dual ground/water distance

\$**VLW,x.x,N,x.x,N,x.x,N,x.x,N,*hh<CR><LF>
 1 2 3 4 5 6 7 8

1. Total cumulative water distance (no use)
2. N=Nautical miles
3. Water distance since reset (no use)
4. N=Nautical miles
5. Total cumulative ground distance (0.000 to 999999.999)
6. N=Nautical miles (no use)
7. Ground distance since reset (0.000 to 999999.999)
8. N=Nautical miles (no use)

VTG-Course over ground and ground speed

\$**VTG,x.x,T,x.x,M,x.x,N,x.x,K,a*hh <CR><LF>
 1 2 3 4 5 6 7 8 9

1. Course over ground, degrees
2. T=True (fixed)
3. Course over ground, degrees
4. M=Magnetic (fixed)
5. Speed over ground, knots
6. N=Knots (fixed)
7. Speed over ground
8. K=km/h (fixed)
9. Mode indicator (A=Autonomous, D=Differential E = Estimated (dead reckoning)
 M=Manual input S=Simulator N=Data not valid, P=Precise)

ZDA-Time and date

\$**ZDA,hhmmss.ss,xx,xx,xxxx,xx,xx*hh<CR><LF>
 1 2 3 4 5 6

1. UTC
2. Day
3. Month
4. Year (UTC)
5. Local zone, hours
6. Local zone, minutes

APPENDIX 7 PARTS LIST/LOCATION

Parts list

This equipment contains complex modules in which fault diagnosis and repair down to component level are not practical (IMO A.694(17)/8.3.1). Only some discrete components are used. FURUNO Electric Co., Ltd. Believes identifying these components is of no value for shipboard maintenance; therefore, they are not listed in this manual. Major modules can be located on the parts location photos on the next page.

ELECTRICAL PARTS LIST	Unit	Antenna Unit GS-1001B
Code No.		
PRINTED CIRCUIT BOARD		
20P8234A, MAIN		—
20P8222A, GNSS_LNA		—

ELECTRICAL PARTS LIST	Unit	Display Unit GS-1002
Code No.		
PRINTED CIRCUIT BOARD		
20P8209A, MAIN		—
20P8210, PNL		—
20P8213, CAN		—
20P8218, CAN-FIL		—
LCD		
NL6448BC18-01F		—

ELECTRICAL PARTS LIST	Unit	Junction Box GS-1003
Code No.		
PRINTED CIRCUIT BOARD		
20P8221, TB		—

Parts location

Antenna Unit GS-1001B

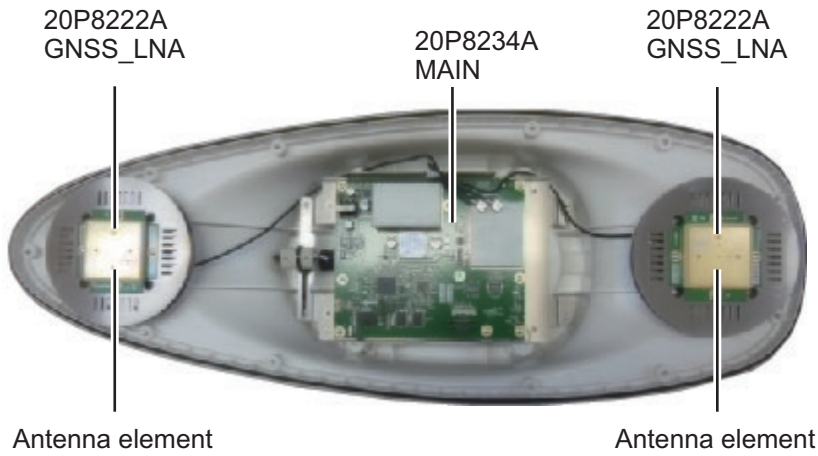

Display Unit GS-1002

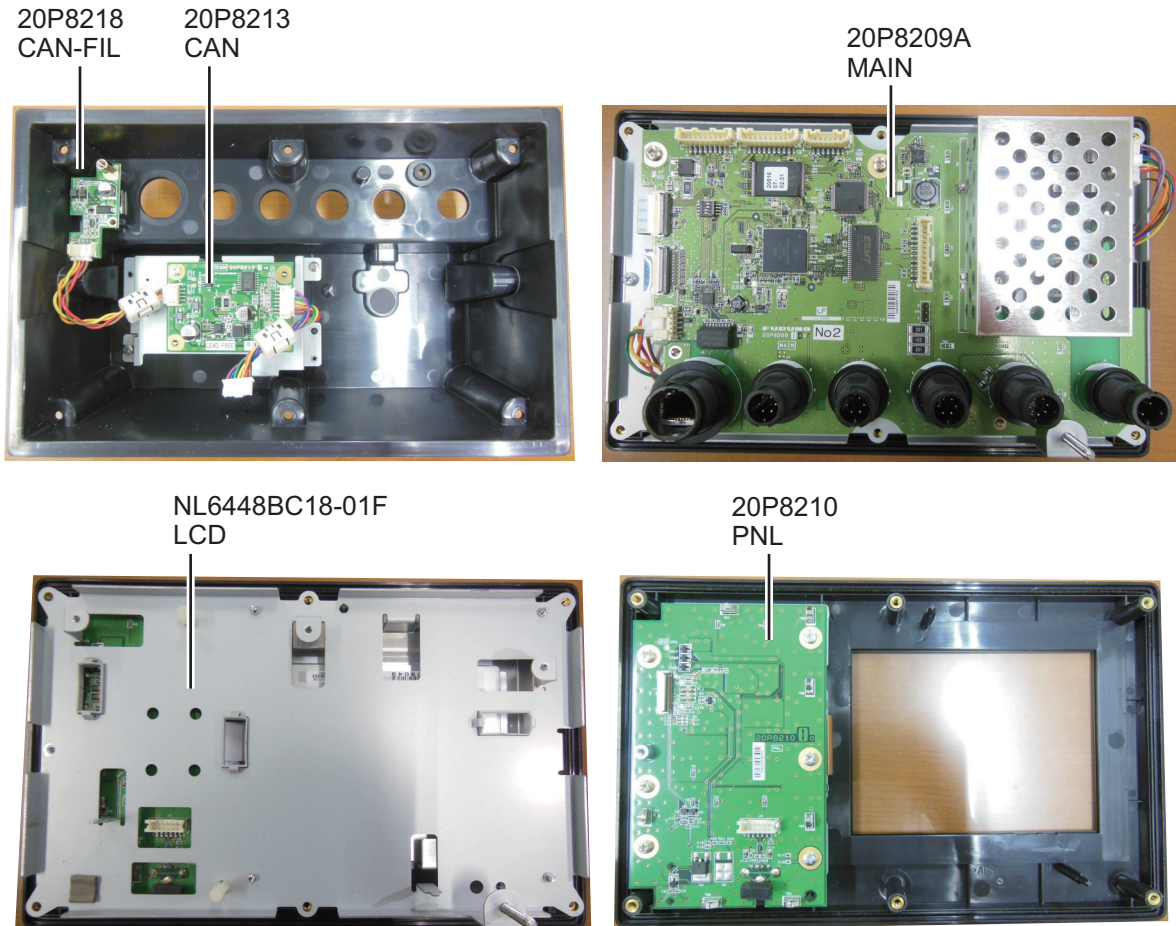

Display unit, cover opened

APPENDIX 7 PARTS LIST/LOCATION

Junction Box GS-1003

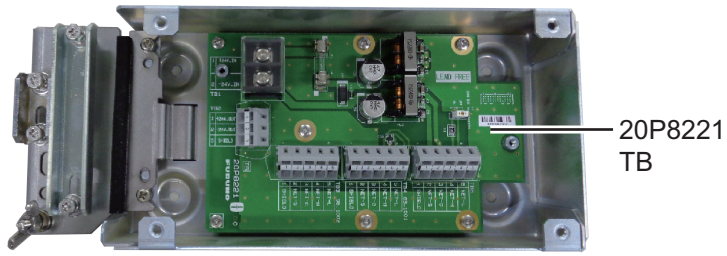

Display Unit DS-600

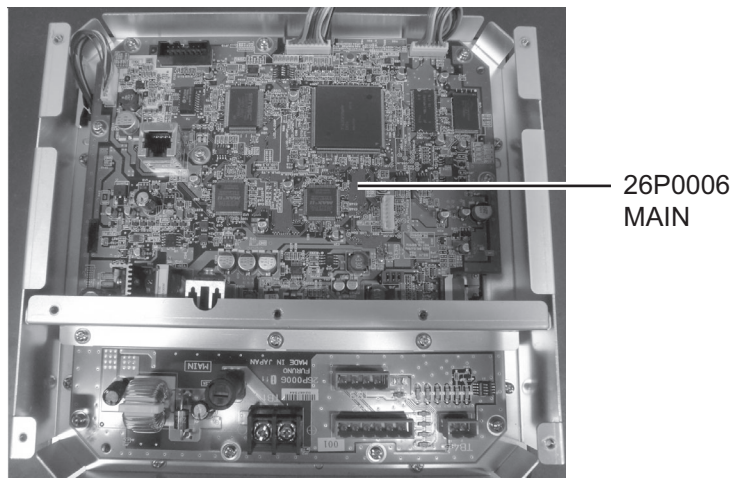
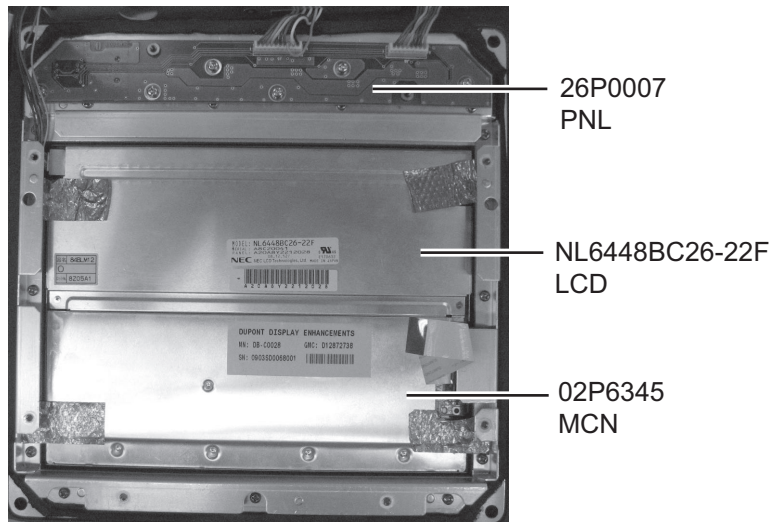

APPENDIX 8 JIS CABLE GUIDE

Cables listed in the manual are usually shown as Japanese Industrial Standard (JIS). Use the following guide to locate an equivalent cable locally.

JIS cable names may have up to 6 alphabetical characters, followed by a dash and a numerical value (example: DPYC-2.5).

For core types D and T, the numerical designation indicates the *cross-sectional Area (mm²)* of the core wire(s) in the cable.

For core types M and TT, the numerical designation indicates the *number of core wires* in the cable.

1. Core Type

D: Double core power line
 T: Triple core power line
 M: Multi core
 TT: Twisted pair communications
 (1Q=quad cable)

2. Insulation Type

P: Ethylene Propylene
 Rubber

3. Sheath Type

Y: PVC (Vinyl)

4. Armor Type

C: Steel

5. Sheath Type

Y: Anticorrosive vinyl
 sheath

6. Shielding Type

S: All cores in one sheath
 -S: Individually sheathed cores
 SLA: All cores in one shield, plastic
 tape w/aluminum tape
 -SLA: Individually shielded cores,
 plastic tape w/aluminum tape



DPYCY



TPYCY

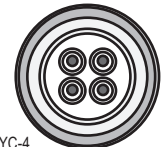

MPYC-4

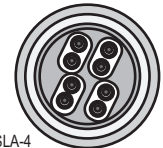

TTYCSLA-4

EX: ^{1 2 3 4 5 6} TTYCYSLA - 4
 Designation type # of twisted pairs

EX: ^{1 2 3 4} MPYC - 4
 Designation type # of cores

The following reference table lists gives the measurements of JIS cables commonly used with Furuno products:

Type	Core		Cable Diameter	Type	Core		Cable Diameter
	Area	Diameter			Area	Diameter	
DPYC-1.5	1.5mm ²	1.56mm	11.7mm	TTYCS-1	0.75mm ²	1.11mm	10.1mm
DPYC-2.5	2.5mm ²	2.01mm	12.8mm	TTYCS-1T	0.75mm ²	1.11mm	10.6mm
DPYC-4	4.0mm ²	2.55mm	13.9mm	TTYCS-1Q	0.75mm ²	1.11mm	11.3mm
DPYC-6	6.0mm ²	3.12mm	15.2mm	TTYCS-4	0.75mm ²	1.11mm	16.3mm
DPYC-10	10.0mm ²	4.05mm	17.1mm	TTYCSLA-1	0.75mm ²	1.11mm	9.4mm
DPYCY-1.5	1.5mm ²	1.56mm	13.7mm	TTYCSLA-1T	0.75mm ²	1.11mm	10.1mm
DPYCY-2.5	2.5mm ²	2.01mm	14.8mm	TTYCSLA-1Q	0.75mm ²	1.11mm	10.8mm
DPYCY-4	4.0mm ²	2.55mm	15.9mm	TTYCSLA-4	0.75mm ²	1.11mm	15.7mm
MPYC-2	1.0mm ²	1.29mm	10.0mm	TTYCY-1	0.75mm ²	1.11mm	11.0mm
MPYC-4	1.0mm ²	1.29mm	11.2mm	TTYCY-1T	0.75mm ²	1.11mm	11.7mm
MPYC-7	1.0mm ²	1.29mm	13.2mm	TTYCY-1Q	0.75mm ²	1.11mm	12.6mm
MPYC-12	1.0mm ²	1.29mm	16.8mm	TTYCY-4	0.75mm ²	1.11mm	17.7mm
TPYC-1.5	1.5mm ²	1.56mm	12.5mm	TTYCY-4S	0.75mm ²	1.11mm	21.1mm
TPYC-2.5	2.5mm ²	2.01mm	13.5mm	TTYCY-4SLA	0.75mm ²	1.11mm	19.5mm
TPYC-4	4.0mm ²	2.55mm	14.7mm	TTYCYS-1	0.75mm ²	1.11mm	12.1mm
TPYCY-1.5	1.5mm ²	1.56mm	14.5mm	TTYCYS-4	0.75mm ²	1.11mm	18.5mm
TPYCY-2.5	2.5mm ²	2.01mm	15.5mm	TTYCYSLA-1	0.75mm ²	1.11mm	11.2mm
TPYCY-4	4.0mm ²	2.55mm	16.9mm	TTYCYSLA-4	0.75mm ²	1.11mm	17.9mm

APPENDIX 9 ALERT LIST

The table below shows the alert no., alert name, text, priority, meaning and remedy for each alert. The alerts table is grouped by device mode. Alerts are not shared between device modes.

Note 1: "Inst." in the following tables denotes "Instance number" for the alert.

Note 2: GS-100 alerts are output only as navigation cluster alerts.

Note 3: In accordance with IEC62923, signals from the Data1 port (IEC61162-2), Data 2 and 4 ports (IEC61162-1) and/or LAN port (IEC61162-450) can be connected to a CAM device for alert management.

Alert I/F 1

No.	Alert name	Text	Priority	Remedy
THD/SDME				
306	DR Mode	DR Mode	Caution/B	If this alert occurs frequently, contact your dealer.
THD				
240	System Fault	System Fault	Warning/B	Restart the GS-100. If the alert occurs again, contact your dealer.
SDME				
309	SDME Fault	SDME Fault	Caution/B	Restart the GS-100. If the alert occurs again, contact your dealer.

Alert I/F 2

No.	Inst.	Alert name	Text	Priority	Remedy
THD/SDME					
430306	2	DR Mode	GNSS Core(2) Fault	Caution/B	If this alert occurs frequently, contact your dealer.
	3		GNSS Core(3) Fault	Caution/B	
	5		Too few Common Satellites	Caution/B	
THD					
3062	2	System Fault	GNSS Core(2) Fault	Warning/B	Restart the GS-100. If the alert occurs again, contact your dealer.
	3		GNSS Core(3) Fault	Warning/B	
	5		Too few Common Satellites	Warning/B	
	6		Antenna Unit Connection Lost	Warning/B	
	7		Rate gyro broken down	Warning/B	
	8		Accelerometer broken down	Warning/B	
	9		Settling failure	Warning/B	

No.	Inst.	Alert name	Text	Priority	Remedy
SDME					
430309	2	SDME Fault	GNSS Core(2) Fault	Caution/B	Restart the GS-100. If the alert occurs again, contact your dealer.
	3		GNSS Core(3) Fault	Caution/B	
	5		Too few Common Satellites	Caution/B	
	6		Antenna Unit Connection Lost	Caution/B	
	7		Rate gyro broken down	Caution/B	
	8		Accelerometer broken down	Caution/B	
	9		Settling failure	Caution/B	

Legacy

No.	Text	Priority	Meaning	Remedy
210	HDOP exceeded	Caution	The value of HDOP (Horizontal Dilution of Precision) is 4 or above. HDOP threshold being permanently set to 4.	If the same state continues for five minutes, contact your dealer.
211	No calculation of position Abbreviated messages: No calculation of POSN	Caution	The signal from GPS core is not received for three seconds.	Restart the GS-100. If the alert occurs again, contact your dealer.
212	Loss of position	Caution	No positioning data.	If the same state continues for five minutes, contact your dealer.
240	System fault	Caution	Can not communicate with GS-1001.	Restart the GS-100. If the alert occurs again, contact your dealer.
301	Dead-Reckoning	Warning	The heading is calculated using ROT, not GNSS position.	If this condition frequently occurs, contact your dealer.
302	Output Stopped (HDG)	Caution	The heading output stopped.	If the same state continues for five minutes, contact your dealer.
303	EXT HDG/ROT	Caution	Using external data to supplement calculations.	If this condition frequently occurs, contact your dealer.
311	Output Stopped (Speed)	Caution	The speed output stopped.	If the same state continues for five minutes, contact your dealer.
312	EXT HDG applied	Warning	Using external data to supplement calculations.	If this condition frequently occurs, contact your dealer.
321	Rate gyro broken down	Caution	Rate gyro malfunction	Contact your dealer.
322	Accelerometer broken down	Caution	Accelerometer malfunction	Contact your dealer.

Note: After alert ID 312 is released, the deviation for all speeds other than in the bow direction increases over time. For details on these increases, see the following tables.

Table 1 Maximum error for transverse speed

Dead-Reckoning time (s)	Z=10m	Z=20m	Z=30m	Z=40m	Z=50m
	Transverse speed error (kn)				
0	0.0	0.0	0.0	0.0	0.0
5	-0.02828	-0.05656	-0.08483	-0.11311	-0.14139
10	-0.05656	-0.11311	-0.16967	-0.22622	-0.28278
20	-0.11311	-0.22622	-0.33933	-0.45244	-0.56555
30	-0.16967	-0.33933	-0.509	-0.67867	-0.84833
40	-0.19794	-0.45244	-0.67867	-0.90489	-1.13111
50	-0.22622	-0.56555	-0.84833	-1.13111	-1.41389
60	-0.28278	-0.67867	-1.018	-1.35733	-1.69666

Z: Height of antenna unit GS-1001

Table 2 Typical error for transverse speed

Dead-Reckoning time (s)	Z=10m	Z=20m	Z=30m	Z=40m	Z=50m
	Transverse speed error (kn)				
0	0.0	0.0	0.0	0.0	0.0
5	-0.01131	-0.02262	-0.03393	-0.04524	-0.05656
10	-0.02262	-0.04524	-0.06787	-0.09049	-0.11311
20	-0.04524	-0.09049	-0.13573	-0.18098	-0.22622
30	-0.06787	-0.13573	-0.2036	-0.27147	-0.33933
40	-0.09049	-0.18098	-0.27147	-0.36195	-0.45244
50	-0.11311	-0.22622	-0.33933	-0.45244	-0.56555
60	-0.13573	-0.27147	-0.4072	-0.54293	-0.67867

Z: Height of antenna unit GS-1001

APPENDIX 10 DISPLAY FOR DS-600

The display of data received from a GS-100 and DS-60 can be switched on the sub display DS-600.

Installation

The signals from GS-100 and DS-60 are directly output to the display unit DS-600. Connect the cables as shown in the figure below.

- Connect the cable between DATA1 port of the display unit GS-1002 and the TB3 port of the display unit DS-600.
- Connect the cable between TB1/TB2 port of the display unit DS-600 and the TB10 or TB11 port of the distributor unit DS-610.

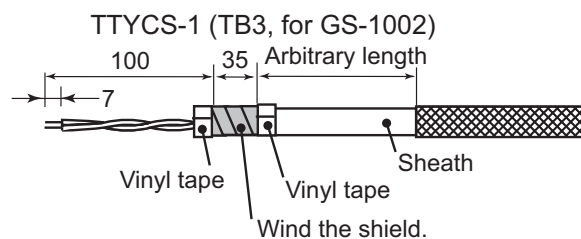
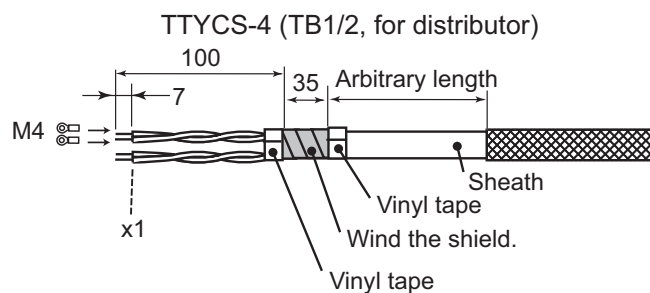
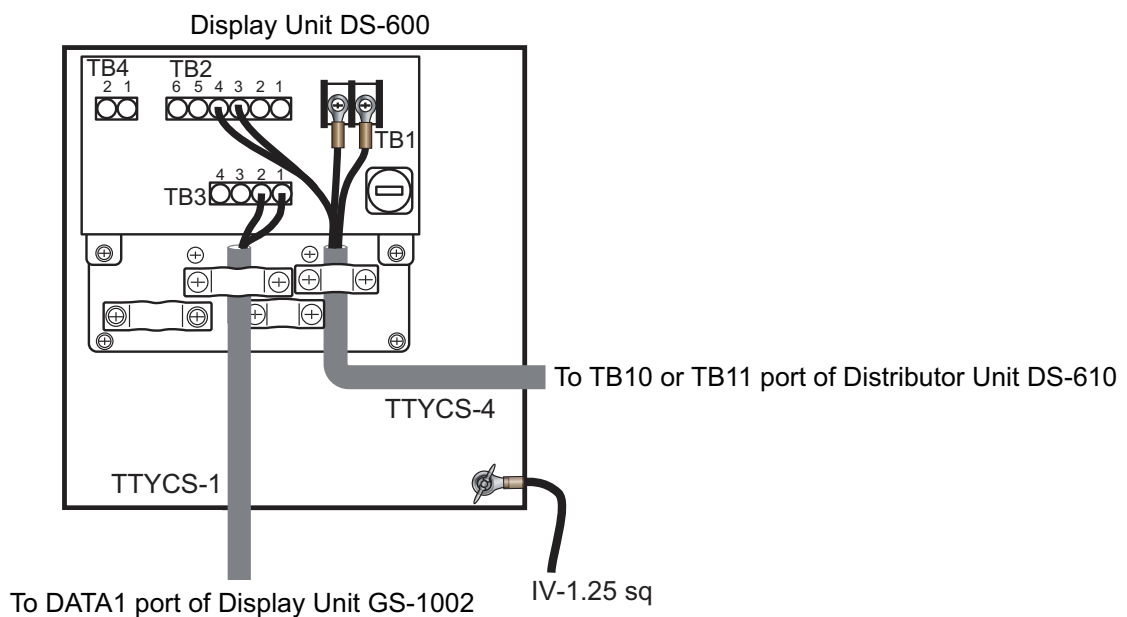

For details, see the Installation manual for DS-60.

Presetting

The following settings must be set by a serviceman.

- When using the DS-600 as the sub display for the GS-100, set [Operation] to [Sub] in the [Service] menu for DS-60 (see subsection 8.5.2).
- When using the DS-600 as the sub display for the GS-100 and DS-60, set [Operation] to [Satellite] in the [Service] menu for DS-60 (see subsection 8.5.2).
- Set the ship size and antenna position for GS-100 (see page 8-21) to the same settings as the DS-60.

For details, see the Installation manual for DS-60.

Switching the data

To switch the data between GS-100 and DS-60, long-press the **DISP** key of the display unit DS-600. "Ground" or "Water" is displayed at the right top of the display for DS-60, "SAT" for GS-100.

Example: Navigation data display

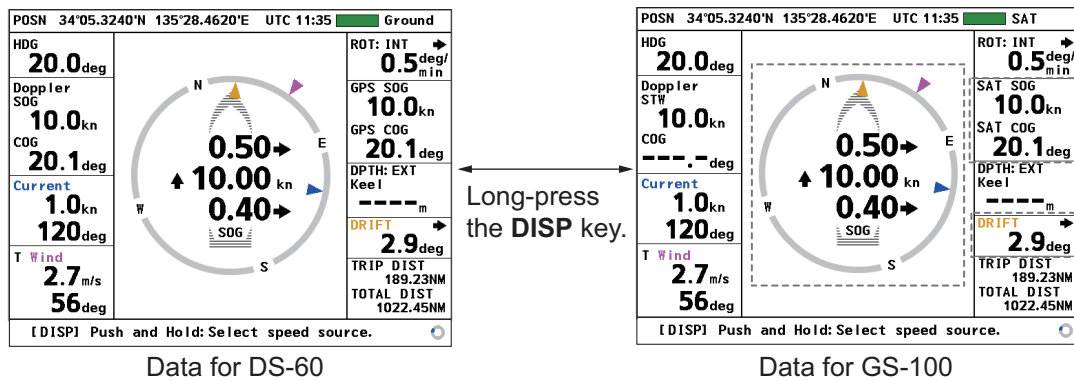

⋮: Data from GS-100 are displayed.
(Others are from DS-60.)

**SPECIFICATIONS OF SATELLITE SPEED LOG
GS-100**

1 GENERAL

- 1.1 Measurement range
 - Speed Fore-aft: -60.0 to +60.0 kn, Port-stbd: -60.0 to +60.0 kn
 - Trip distance 0.0 to 999999.9 NM or 0.00 to 999999.99 NM
 - Heading 0.0 to 359.9° or 0.00 to 359.99°
- 1.2 Accuracy
 - Speed 2.0% or 0.2 kn whichever is the greater (tracking satellite: 3 or 4)
0.02 kn rms (tracking satellite: 5 or more, at antenna position)
0.08 kn rms (tracking satellite: 5 or more, at another position)
 - Trip distance 0.01 NM
 - Heading/Roll/Pitch 0.4° rms
- 1.3 Resolution
 - Speed 0.1 kn or 0.01 kn (selected from menu)
 - Heading/Roll/Pitch 0.1° or 0.01° (selected from menu)
 - ROT 0.1°/min. or 0.01°/min.
- 1.4 Following speed 45°/s
- 1.5 Settling time 90 s approx.
- 1.6 Heading backup 1° or less (satellite obstructed time within 5 min.)

2 ANTENNA UNIT (GNSS BLOCK)

- 2.1 Receiving Frequency L1: 1575.42 MHz (GPS/Galileo/QZSS),
1602.5625 MHz (GLONASS)
- 2.2 Tracking code C/A code (GPS/QZSS), E1B (Galileo), 10F (GLONASS)
- 2.3 Number of channel GPS: 12 channels
GLONASS: 10 channels
Galileo: 8 channels
QZSS: 2 channels
- 2.4 Accuracy (dependent on ionospheric activity and multipath)
GNSS: 5 m approx. (2drms, HDOP<4)
SBAS: 4 m approx. (2drms, HDOP<4)

3 DISPLAY UNIT (GS-1002)

- 3.1 Screen 5.7-inch color LCD, 116.16 x 87.12 mm, 640 x 480 (VGA)
- 3.2 Picture color 262,144 colors
- 3.3 Brilliance 700 cd/m² typical
- 3.4 Display mode Text, Graphic
- 3.5 Visible distance Speed: 4.5 m, Trip distance: 2.2 m, Heading: 5.5 m
Others: 0.625 m nominal

4 DISPLAY UNIT (DS-600, OPTION)

- 4.1 Screen 8.4-inch, Color LCD, 640 x 480 dot (VGA)
- 4.2 Brilliance 0.2 to 500 cd/m²

- 4.3 View angle Up/down/left/right: 75° or more (color is not considered)
- 4.4 Dimmer External dimmer control available
- 4.5 Backlight life 30,000 hrs approx. (+55°C)

5 INTERFACE

- 5.1 Number of ports
 - Serial I/O: 3 ports, O: 1 port
 - Ethernet 1 port, 100base-TX
 - USB 1 port for maintenance
 - CAN (spare) 1 port
 - 5.2 Data format IEC61162-1/2 (NMEA0183 V1.5/2.0/4.0), IEC61162-450
 - 5.3 Data sentence
 - Input ACK, ACM, ACN, CUR, DPT, HBT, HDG, HDT*, MWV, ROT, SRP, THS, VBW, VDR
 - Output ALC, ALF, ALR, ARC, HBT, HDT*, HRM, POS, ROT, SRP, THS, VBW, VLW, VTG, ZDA
 - 5.4 Output proprietary sentence
 - PFEC GPatt, GPhve, GPimu, Ilalr, pidat, rminf, ds060
 - 5.5 Ethernet 100Base-TX, RJ45 connector (waterproof)
 - IEC61162-450 transmission group
 - IN: MISC, SATD, NAVD, NETA
 - OUT: Arbitrary (default: NAVD)
 - Other Network Function (ONF) group of IEC61162-450
 - SNTP, HTTP, Furuno Management Protocol (FMP)
 - Sentences
 - IN: ACK, ACM, ACN, CUR, DPT, HBT, HDG, HDT*, MWV, ROT, SRP, THS, VBW, VDR
 - OUT: ALC, ALF, ALR, ARC, HBT, HDT*, HRM, POS, ROT, SRP, THS, VBW, VLW, VTG, ZDA
 - Sentence type
 - CRP (Command-response pair) ACK, ACN, ALC, ALR, ALF, ARC, POS
 - SBM (Sensor broadcast message)
 - HBT, HDG, HDT, ROT, THS, VBW, VDR, VLW, VTG, ZDA
 - 5.6 Contact closure (optional IF-2503 required)
 - Dead reckoning, IF-2503 power fail
- *: Not used by SOLAS ships.

6 POWER SUPPLY

- 6.1 Junction box 24 VDC: 0.6 A (supplied to display unit and antenna unit)
- 6.2 Rectifier (option)
 - PR-62 100/110/115/220/230 VAC, 1 phase, 50/60Hz
- 6.3 AC/DC power supply unit (option)
 - PR-240 100-115/200-230 VAC, 1 phase, 50/60 Hz, 24VDC for back-up
 - PR-241 100-230 VAC, 1 phase, 50/60 Hz, 24VDC for back-up

7 ENVIRONMENTAL CONDITIONS

7.1 Ambient temperature

Antenna unit -25°C to +55°C

Display unit/ Junction box -15°C to +55°C

Display unit (DS-600) -25°C to +55°C

7.2 Relative humidity 95% or less at +40°C

7.3 Degree of protection

Antenna unit IP56

Display unit IP25, IPX0 (USB port cover opened)

Junction box IP22

Display unit (DS-600) IP56 (front panel)

7.4 Vibration IEC 60945 Ed.4

8 UNIT COLOR

8.1 Antenna unit N9.5 (fixed)



8.2 Display unit N2.5 (fixed)

8.3 Junction box N3.0

PACKING LIST

GS-1001B-N, GS-1001B-NHK

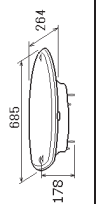
208G-X-9851 -5 1/1
A-1

NAME	OUTLINE	DESCRIPTION/CODE No.	QTY
ユニット			
空中線部 ANTENNA UNIT		GS-1001B-* 000-035-976-00 **	1
工事材料			
工事材料 INSTALLATION MATERIALS		GP20-03503 001-543-130-00	1

コード番号末尾の[**]は、選用品の代表コードを表します。
CODE NUMBER ENDING WITH "**" INDICATES THE CODE NUMBER OF REPRESENTATIVE MATERIAL.

(略図の寸法は、参考値です。 DIMENSIONS IN DRAWING FOR REFERENCE ONLY.)



CN

C7279-Z01-F

PACKING LIST

GS-1001B-A, GS-1001B-AHK

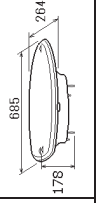
208G-X-9852 -5 1/1
A-2

NAME	OUTLINE	DESCRIPTION/CODE No.	QTY
ユニット			
空中線部 ANTENNA UNIT		GS-1001B-* 000-035-976-00 **	1
工事材料			
工事材料 INSTALLATION MATERIALS		GP20-03502 001-543-140-00	1

コード番号末尾の[**]は、選用品の代表コードを表します。
CODE NUMBER ENDING WITH "**" INDICATES THE CODE NUMBER OF REPRESENTATIVE MATERIAL.



(略図の寸法は、参考値です。 DIMENSIONS IN DRAWING FOR REFERENCE ONLY.)

CN

C7279-Z02-F

PACKING LIST

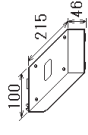
GS-1003, GS-1003-HK







NAME	UNIT	OUTLINE	DESCRIPTION/CODE No.	QTY
ユニット	UNIT			
接続箱	JUNCTION BOX		GS-1003* 000-026-891-00 **	1
予備品	SPARE PARTS			
予備品	予備品		SP20-01501 001-321-420-00	1
SPARE PARTS	SPARE PARTS			
工事材料	INSTALLATION MATERIALS			
工事材料	工事材料		CP20-03701 001-321-430-00	1
INSTALLATION MATERIALS	INSTALLATION MATERIALS			

コード番号末尾の[*]**は、選択品の代表コードを表します。
CODE NUMBER ENDING WITH "**" INDICATES THE CODE NUMBER OF REPRESENTATIVE MATERIAL

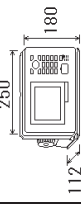
型式/コード番号が空段の場合、下段より上段に代わる過渡期品であり、どちらかが入っています。なお、品質は変わりません。
TWO TYPES AND CODES MAY BE LISTED FOR AN ITEM. THE LOWER PRODUCT MAY BE SHIPPED IN PLACE OF THE UPPER PRODUCT. QUALITY IS THE SAME.
(略図の寸法は、参考値です。DIMENSIONS IN DRAWING FOR REFERENCE ONLY.)

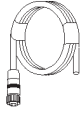
PACKING LIST

GS-1002-E, GS-1002-J, GS-1002-EHK, GS-1002-JHK

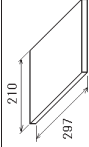



NAME	UNIT	OUTLINE	DESCRIPTION/CODE No.	QTY
ユニット	UNIT			
表示部	DISPLAY UNIT		GS-1002-* 000-026-885-00 **	1
付属品	ACCESSORIES			
フィルムクリーナー	FILM CLEANING CLOTH		19-028-3125-7 100-360-677-10	1
工事材料	INSTALLATION MATERIALS			
ケーブル(ワズコ)NMEA	CABLE ASSEMBLY		FRU-NMEA-PFF-060 000-194-606-10	1
ケーブル(組品)MJ	CABLE ASSEMBLY		MJ-A3SPF0015-060C 001-265-430-00	1
ケーブル組品MJ	CABLE ASSEMBLY		MJ-A6SPF0003-050C 000-154-054-10	1
工事材料	INSTALLATION MATERIALS			
工事材料	工事材料		CP20-03401 001-321-400-00	1
図書	DOCUMENT			
取扱説明書	OPERATOR'S MANUAL		0M*-72790-* 000-190-205-1* **	1

コード番号末尾の[*]**は、選択品の代表コードを表します。
CODE NUMBER ENDING WITH "**" INDICATES THE CODE NUMBER OF REPRESENTATIVE MATERIAL

(略図の寸法は、参考値です。DIMENSIONS IN DRAWING FOR REFERENCE ONLY.)

CODE NO.	001-265-330-00	2086-X-9401--2	1/1
TYPE	CP20-03501		

工事材料表





INSTALLATION MATERIALS		数量 QTY		用途/備考 REMARKS	
番号 NO.	名称 NAME	略図 OUTLINE	型名/規格 DESCRIPTIONS	数量 QTY	用途/備考 REMARKS
1	ケーブル用ゴムブッシュ CABLE RUBBER BUSH		20-030-1105-2 CODE NO. 100-340-192-10	1	
2	ケーブル用ワイヤ CABLE TIE		CV-150B CODE NO. 000-167-183-10	4	
3	六角ナット HEX NUT		M10 SUS316L CODE NO. 000-167-490-10	8	
4	平垫金 FLAT WASHER		M10 SUS316L CODE NO. 000-167-416-10	4	
5	ハネ垫金 SPRING WASHER		M10 SUS316L CODE NO. 000-167-389-10	4	

(略図の寸法は、参考値です。 DIMENSIONS IN DRAWING FOR REFERENCE ONLY.)

FURUNO ELECTRIC CO., LTD.

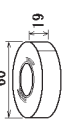
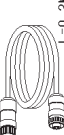
C7279-M01-C

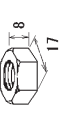
CODE NO.	001-543-140-00	2086-X-9402-8	1/1
TYPE	CP20-03502		

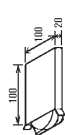
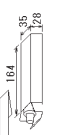
INSTALLATION MATERIALS		数量 QTY		用途/備考 REMARKS	
番号 NO.	名称 NAME	略図 OUTLINE	型名/規格 DESCRIPTIONS	数量 QTY	用途/備考 REMARKS
1	ビニールテープ VINYL TAPE		0.2X19X1000MM 7H CODE NO. 000-172-697-10	1	
2	ケーブル用ワイヤ CABLE ASSEMBLY		60-580-0008 CODE NO. 000-193-297-11	1	
3	ケーブル用ワイヤ CABLE TIE		CV-150B CODE NO. 000-167-183-10	4	
4	六角ナット HEX NUT		M10 SUS316L CODE NO. 000-167-490-10	8	
5	平垫金 FLAT WASHER		M10 SUS316L CODE NO. 000-167-416-10	4	
6	ハネ垫金 SPRING WASHER		M10 SUS316L CODE NO. 000-167-389-10	4	
7	自己接着テープ SELF-BONDING TAPE		NO.15 CODE NO. 000-174-646-10	1	
8	接着剤 ADHESIVE		TBS211 50G CODE NO. 001-517-370-00	1	

(略図の寸法は、参考値です。 DIMENSIONS IN DRAWING FOR REFERENCE ONLY.)

FURUNO ELECTRIC CO., LTD.



CN

C7279-M02-H

CODE NO.	001-321-430-00	208G-X-9406-0	1/1
TYPE	CP20-03701		

工事材料表

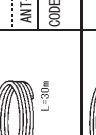
INSTALLATION MATERIALS

番号 NO.	名称 NAME	略図 OUTLINE	型名/規格 DESCRIPTIONS	数量 QTY	用途/備考 REMARKS
1	セルフタッピングビス SELF-TAPPING SCREW		4X20 SUS304 CODE NO. 000-155-350-10	4	
2	ケーブルタイ CABLE TIE		CV-100N CODE NO. 000-162-167-10	1	



型式/コード番号が2段の場合、下段より上段に代わる標準部品であり、どちらが入っています。なお、品質は変わりません。
TWO TYPES AND CODES MAY BE LISTED FOR AN ITEM. THE LOWER PRODUCT MAY BE SHIPPED IN PLACE OF THE UPPER PRODUCT.
QUALITY IS THE SAME.
(略図の寸法は、参考値です。 DIMENSIONS IN DRAWING FOR REFERENCE ONLY.)

CODE NO.		208G-X-9404-1	1/1
TYPE			

工事材料表

GS-100

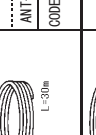
INSTALLATION MATERIALS

番号 NO.	名称 NAME	略図 OUTLINE	型名/規格 DESCRIPTIONS	数量 QTY	用途/備考 REMARKS
1	ケーブル組品 CABLE ASSEMBLY		ANT-DN18MPVC-300 CODE NO. 001-277-330-30	1	選択 TO BE SELECT
2	ケーブル組品 CABLE ASSEMBLY		ANT-DN18MPVC-400 CODE NO. 001-277-340-30	1	選択 TO BE SELECT
3	ケーブル組品 CABLE ASSEMBLY		ANT-DN18MPVC-500 CODE NO. 001-277-350-30	1	選択 TO BE SELECT

型式/コード番号が2段の場合、下段より上段に代わる標準部品であり、どちらが入っています。なお、品質は変わりません。
TWO TYPES AND CODES MAY BE LISTED FOR AN ITEM. THE LOWER PRODUCT MAY BE SHIPPED IN PLACE OF THE UPPER PRODUCT.
QUALITY IS THE SAME.
(略図の寸法は、参考値です。 DIMENSIONS IN DRAWING FOR REFERENCE ONLY.)



表1 TABLE 1

寸法区分 (mm) DIMENSION	公差 (mm) TOLERANCE
L ≤ 50	±1.5
50 < L ≤ 100	±2.5
100 < L ≤ 500	±3

型式銘板
NAMEPLATE

電源
SOURCE

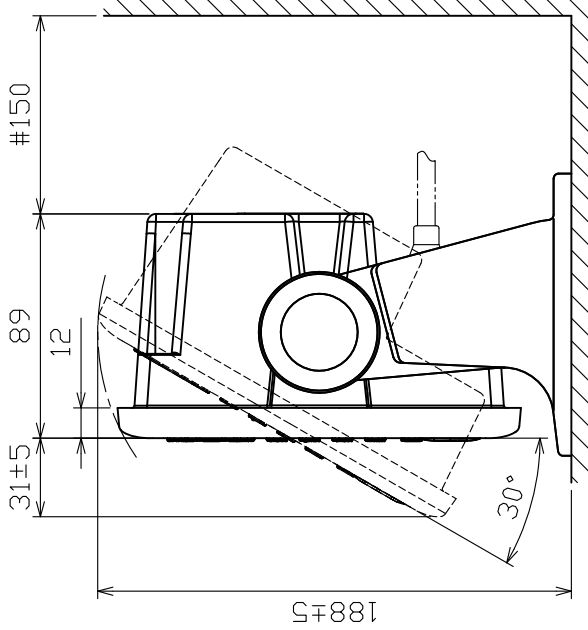
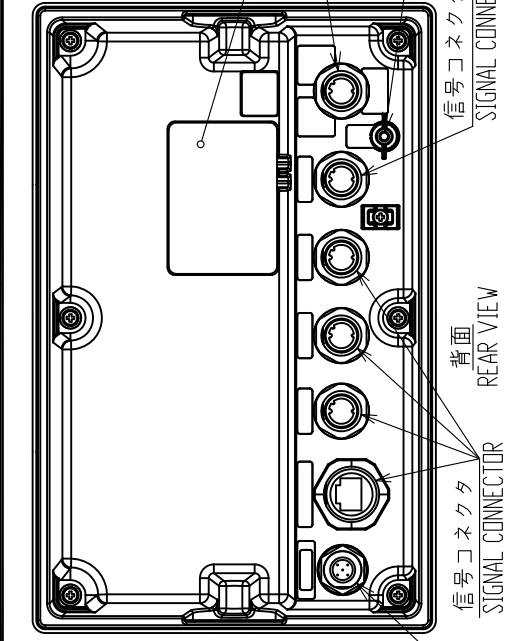
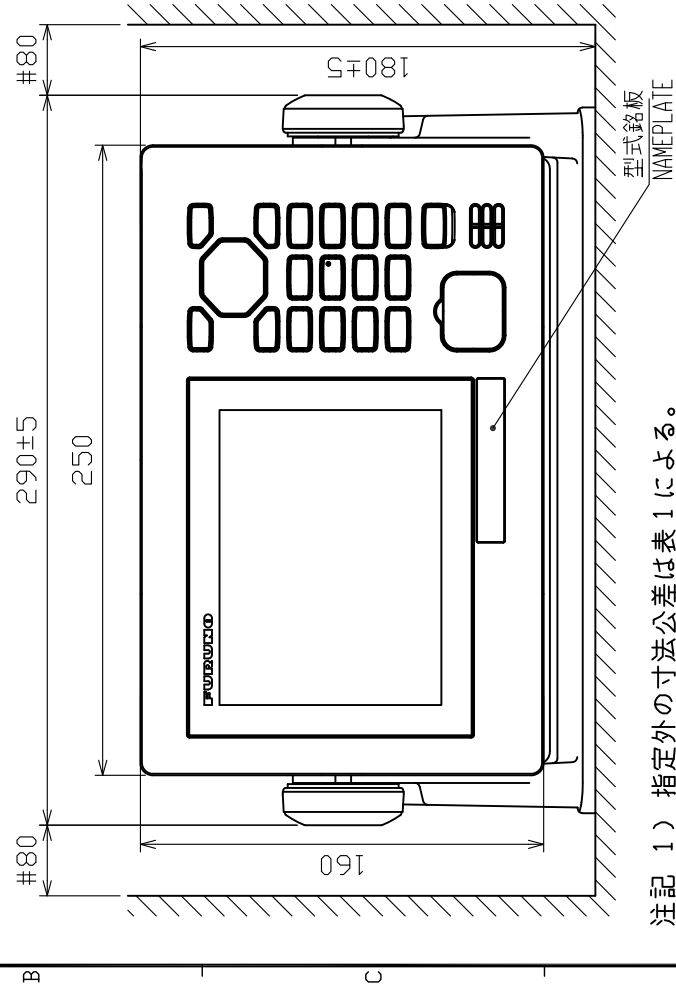
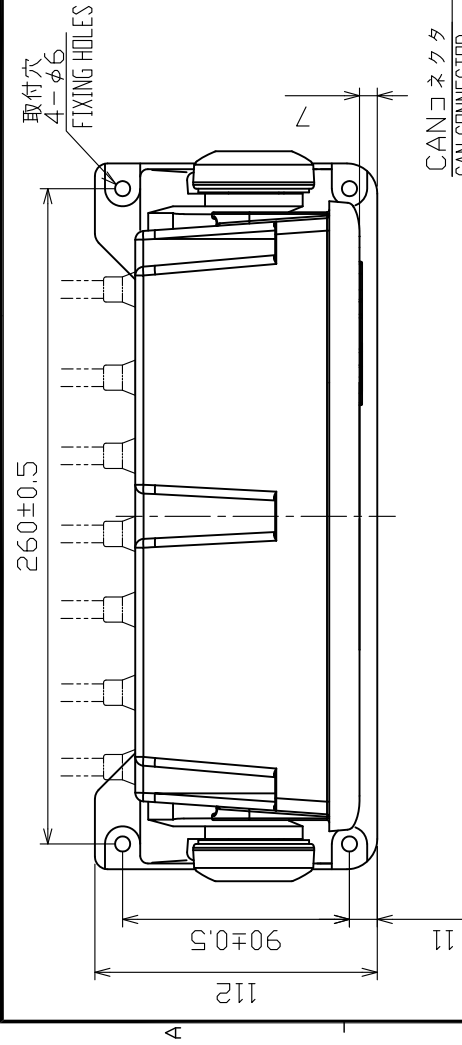
7-ス端子
GND TERMINAL

信号コネクタ
SIGNAL CONNECTOR

信号コネクタ
SIGNAL CONNECTOR

CANコネクタ
CAN CONNECTOR

- 注記 1) 指定外の寸法公差は表 1 による。
 2) # 印寸法は最小サービスペース寸法とする。
 3) 取付用ネジは + トラスタッピング呼び径 5 × 20 を使用のこと。
- NOTE 1. TABLE 1 INDICATES TOLERANCE OF DIMENSIONS WHICH IS NOT SPECIFIED.
 2. # : MINIMUM SERVICE CLEARANCE.
 3. USE TAPPING SCREWS φ5x20 FOR FIXING THE UNIT.

DRAWN 25/May/2021 U.PODDAR	TITLE GS-1002
CHECKED 25/May/2021 T.YAMASAKI	名称 表示部 (卓上装備)
APPROVED 27/May/2021 H.MAKI	外寸図
SCALE 1/3 MASS 1.7 100% 10%	NAME DISPLAY UNIT (TABLETOP MOUNT)
JWG.No. C7279-601-C	REF.No. 20-036-200G-3
OUTLINE DRAWING	



表1 TABLE 1

寸法区分 (mm) DIMENSION	公差 (mm) TOLERANCE
$L \leq 50$	± 1.5
$50 < L \leq 100$	± 2.5
$100 < L \leq 500$	± 3

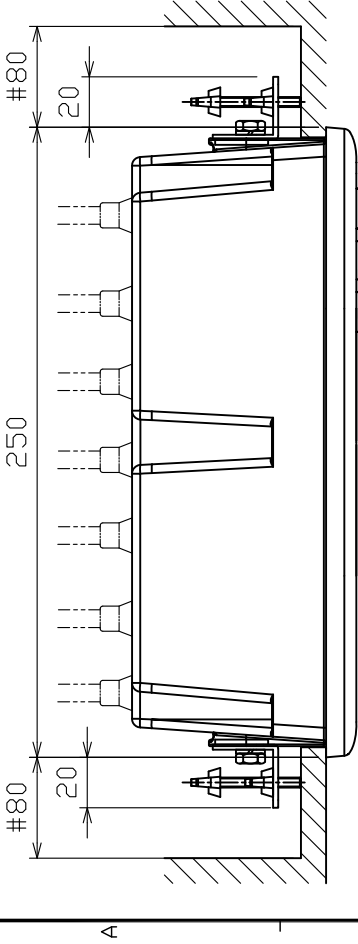
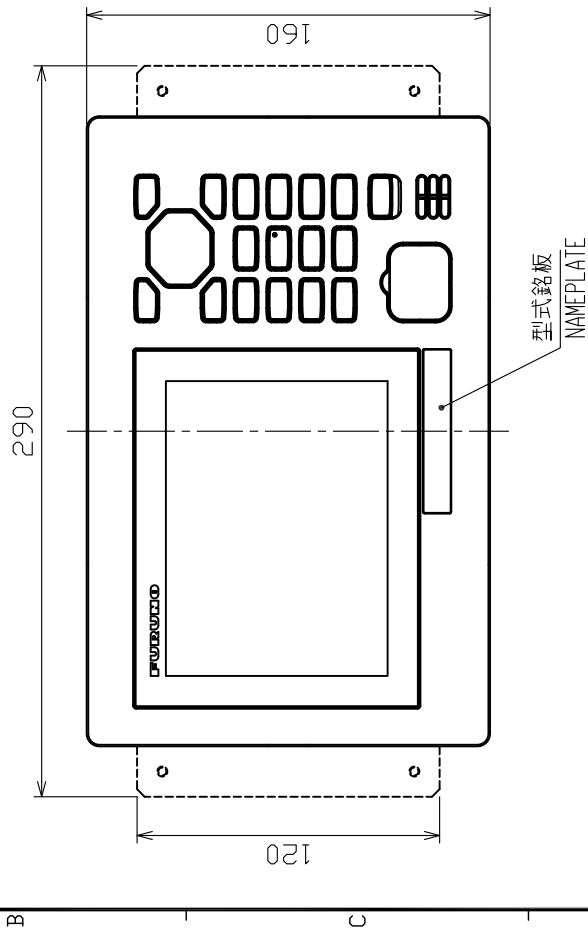
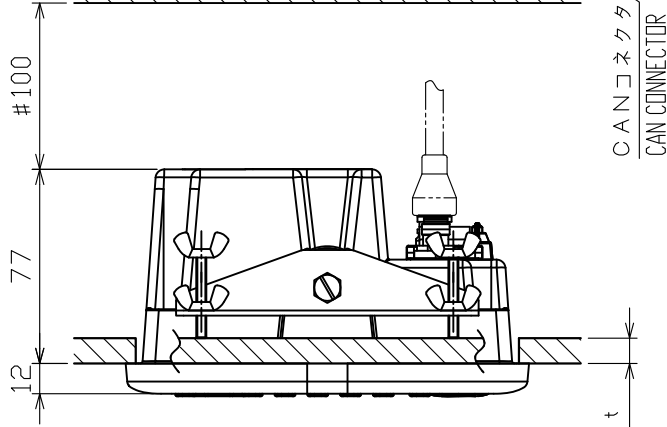
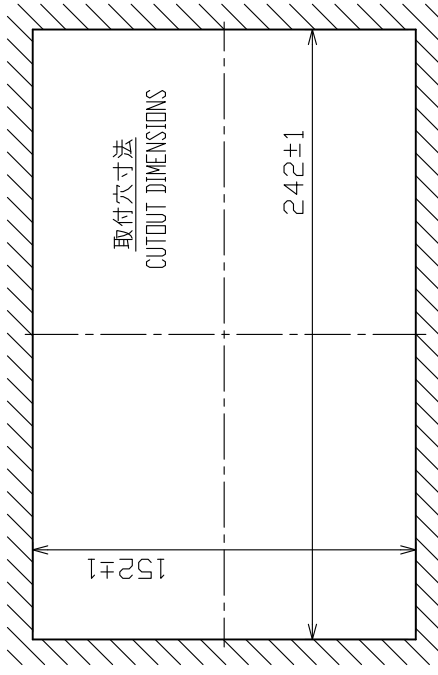

- 注記 1) 指定外の寸法公差は表1による。
 2) #印寸法は最小サービス空間寸法とする。
 3) 壁の厚さ(t)は、3mm以上15mm以下とする。
- NOTE 1. TABLE 1 INDICATES TOLERANCE OF DIMENSIONS WHICH IS NOT SPECIFIED.
 2. # MINIMUM SERVICE CLEARANCE.
 3. BULKHEAD THICKNESS (t): $3 \leq t \leq 15$.

DRAWN	25/May/2021 U.PODDAR	TITLE	GS-1002
CHECKED	25/May/2021 T.YAMASAKI	名称	表示部 (埋込装備 S)
APPROVED	27/May/2021 H-MAKI	NAME	外寸図
SCALE	1/3 MASS 1.7 100% kg		DISPLAY UNIT (FLUSH MOUNT S)
FIG.No.	C7279-603-C	REF.No.	20-036-220G-3
			OUTLINE DRAWING

表1 TABLE 1

寸法区分 (mm) DIMENSION	公差 (mm) TOLERANCE
L ≤ 50	±1.5
50 < L ≤ 100	±2.5
100 < L ≤ 500	±3

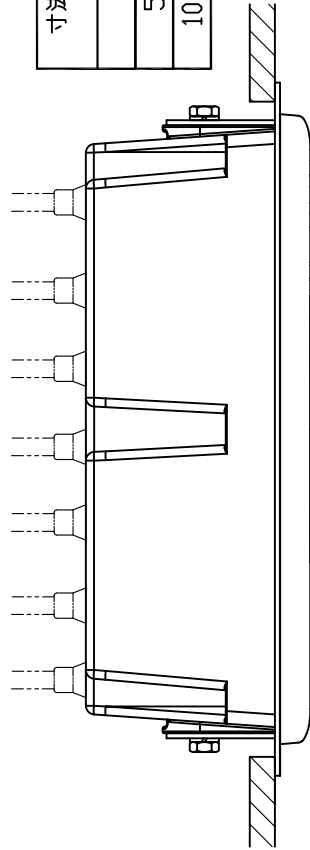

取付穴
4-φ6
FIXING HOLES

14 75 #100

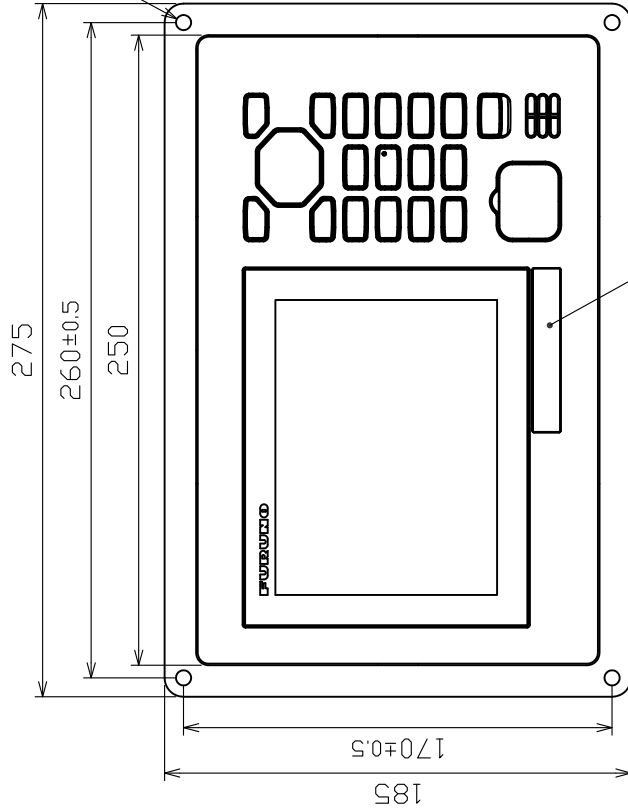

型式銘板
NAMEPLATE

CANコネクタ
CAN CONNECTOR

4-取付穴位置
PILOT HOLES

260±0.5

取付穴寸法
CUTOUT DIMENSIONS

156±1

260±1

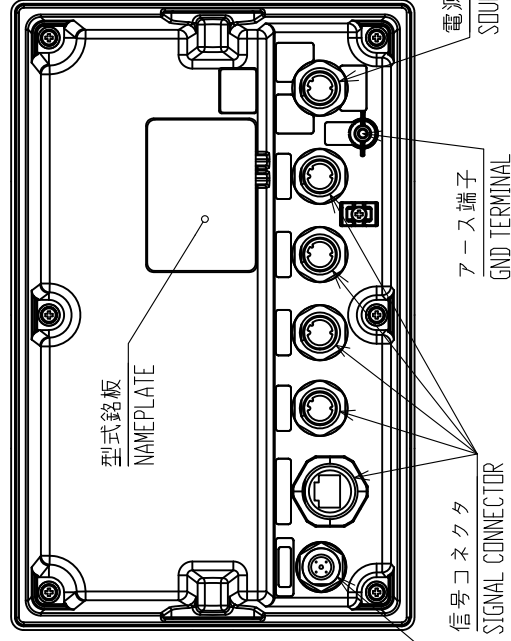

型式銘板
NAMEPLATE

信号コネクタ
SIGNAL CONNECTOR

アース端子
GND TERMINAL

電源
SOURCE

- 注記 1) 指定外の寸法公差は表1による。
 2) #印寸法は最小サービス空間寸法とする。
 3) 取付用ネジは+トラスタックピンネジ呼び径5×20を使用のこと。
- NOTE 1. TABLE 1 INDICATES TOLERANCE OF DIMENSIONS WHICH IS NOT SPECIFIED.
 2. # MINIMUM SERVICE CLEARANCE.
 3. USE TAPPING SCREWS φ5×20 FOR FIXING THE UNIT.

DRAWN 25/May/2021 U.PODDAR	TITLE GS-1002
CHECKED 25/May/2021 T.YAMASAKI	名称 表示部 (埋込装備F)
APPROVED 27/May/2021 H.MAKI GS-100	外寸図
SCALE 1/3 MASS 1.8 100% 10g	NAME DISPLAY UNIT (FLUSH MOUNT F)
JWG.No. C7279-602-C	OUTLINE DRAWING
REF.No. 20-036-210G-3	



表1 TABLE 1

寸法区分 (mm) DIMENSION	公差 (mm) TOLERANCE
L ≤ 50	±1.5
50 < L ≤ 100	±2.5
100 < L ≤ 500	±3
500 < L ≤ 1000	±4



取付台 (マスト) 制作例 (参考)
EXAMPLE OF MOUNTING BASE (MAST)

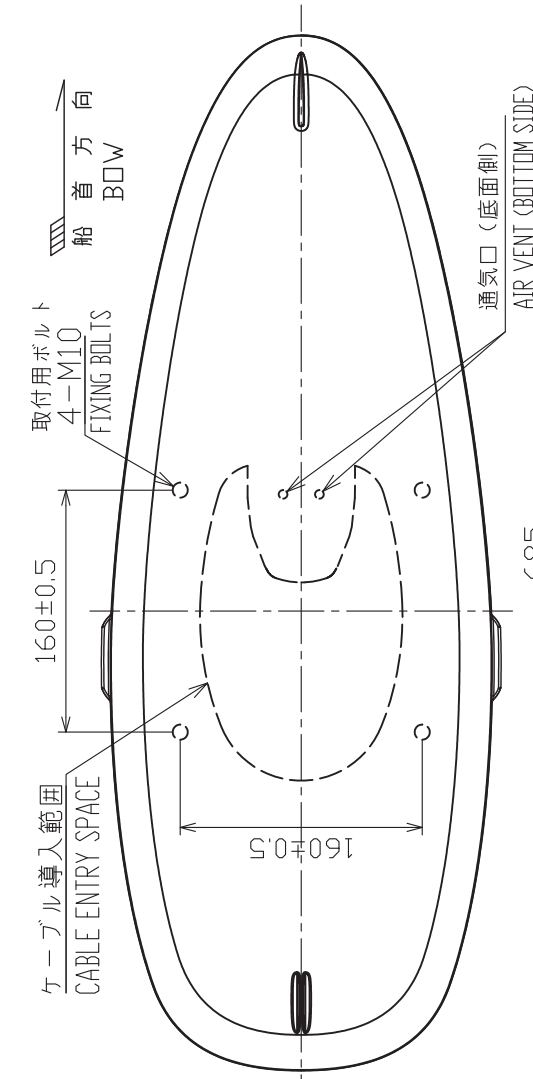
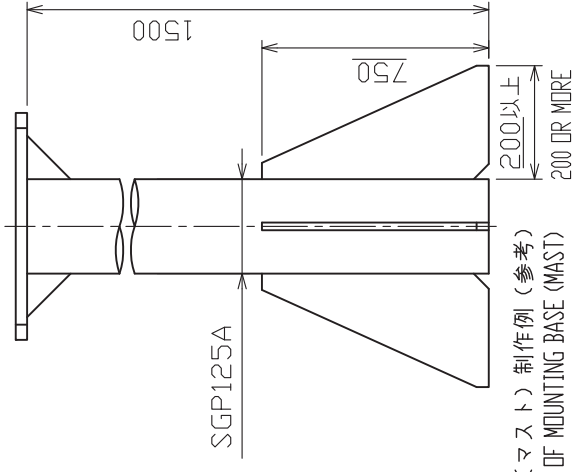
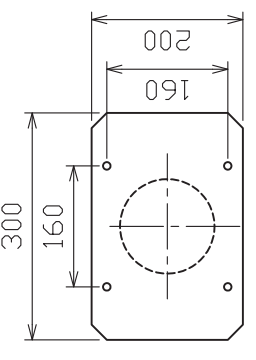
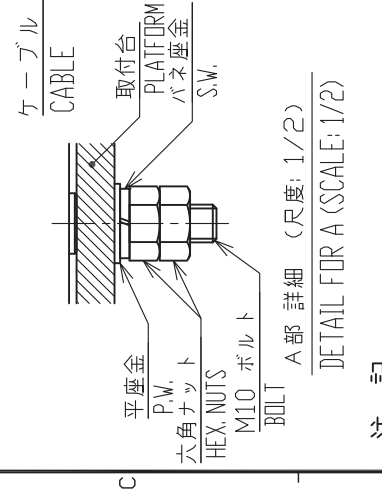
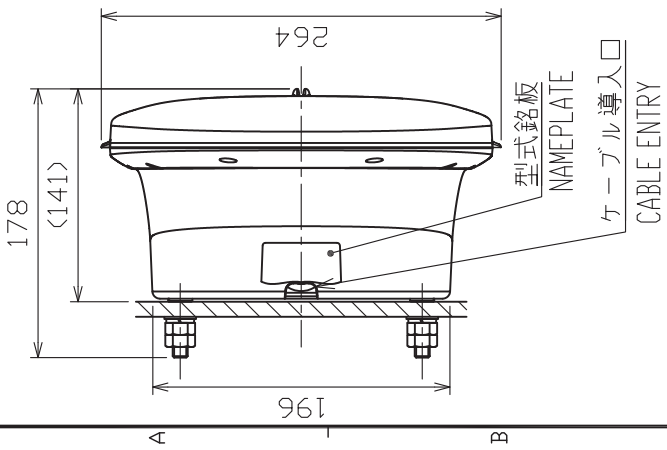

注 記

- 1) 指定外の寸法公差は表 1 による。
- 2) 取付台の厚さ (t) は 5 以上 15 以下とする。

NOTE

1. TABLE 1 INDICATES TOLERANCE OF DIMENSIONS WHICH IS NOT SPECIFIED.
2. THICKNESS OF PLATFORM (t): 5 ≤ t ≤ 15.

DRAWN	CHECKED	APPROVED	SCALE	DMG.No.	TITLE
23/Jan/2018 I.YAMASAKI	23/Jan/2018 H.MAKI	24/Jan/2018 H.MAKI	1/5 MASS 2.8 ±10% 質量はケーブルを含む。 MASS INCLUDES CABLE.	C7279-G05-C	GS-1001 名称 空中線部
					外寸図
					ANTENNA UNIT
					OUTLINE DRAWING

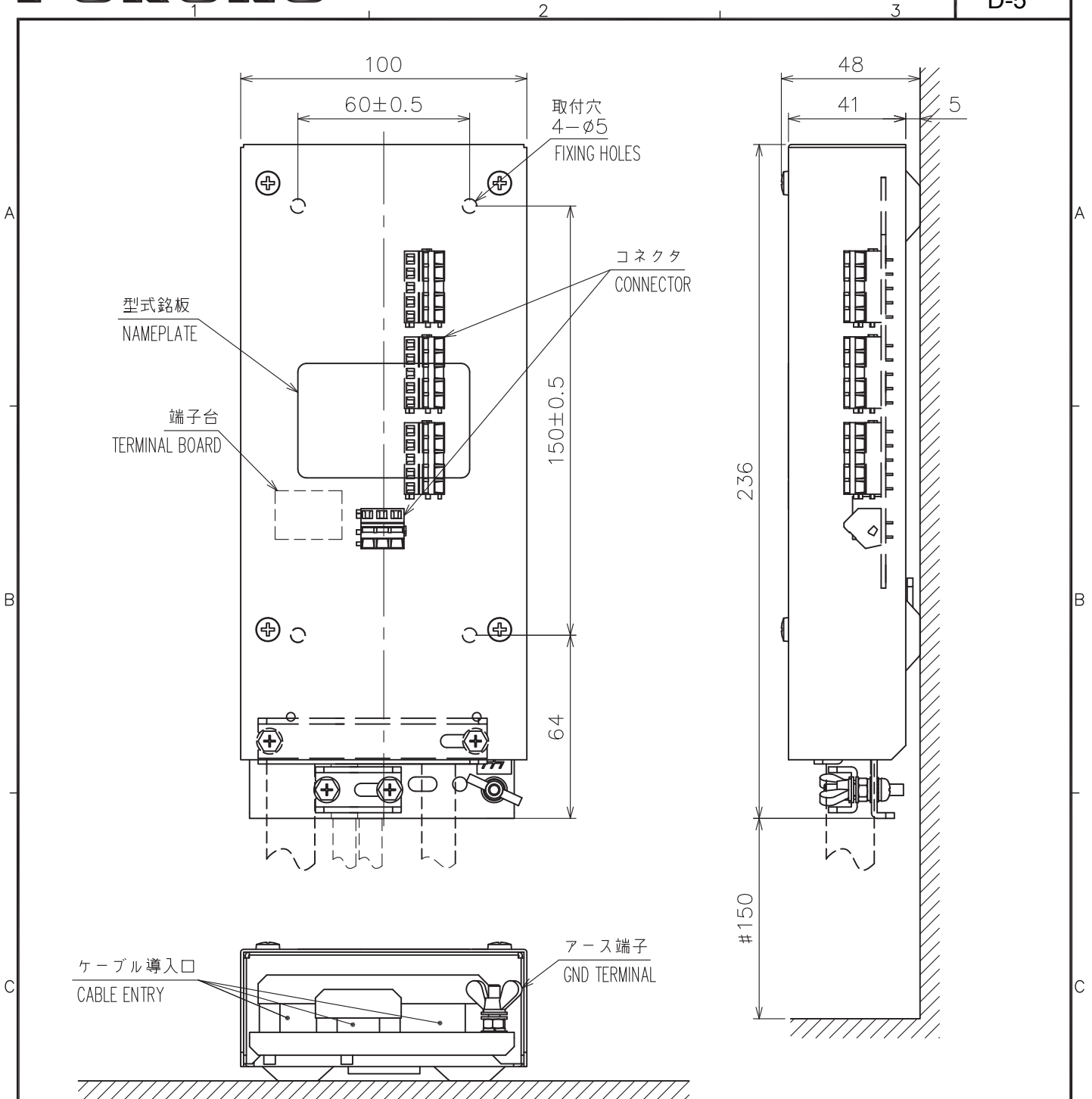

- 注記 1) 指定外の寸法公差は表1による。
 2) #印寸法は最小サービス空間寸法とする。
 3) 取付用ネジはトラスタッピンネジ呼び径4×20を使用のこと。
- NOTE 1. TABLE 1 INDICATES TOLERANCE OF DIMENSIONS WHICH IS NOT SPECIFIED.
 2. #: MINIMUM SERVICE CLEARANCE.
 3. USE TAPPING SCREWS $\phi 4 \times 20$ FOR FIXING THE UNIT.

表1 TABLE 1

寸法区分 (mm) DIMENSION	公差 (mm) TOLERANCE
$L \leq 50$	± 1.5
$50 < L \leq 100$	± 2.5
$100 < L \leq 500$	± 3

DRAWN 13/Feb/2014 I. YAMASAKI	TITLE GS-1003
CHECKED 13/Feb/2014 H. MAKI	名称 接続箱
APPROVED 13/Feb/2014 H. MAKI	外寸図
SCALE 1/2	MASS 0.8 $\pm 10\%$ kg
DWG. No. C7279-G04-B	REF. No. 20-036-300G-2
質量はケーブルを含みません。 MASS DOES NOT INCLUDE CABLE.	
NAME JUNCTION BOX	
OUTLINE DRAWING	

取付穴
4-φ7



表1 TABLE 1

寸法区分 (mm) DIMENSION	公差 (mm) TOLERANCE
L ≤ 50	±1.5
50 < L ≤ 100	±2.5
100 < L ≤ 500	±3

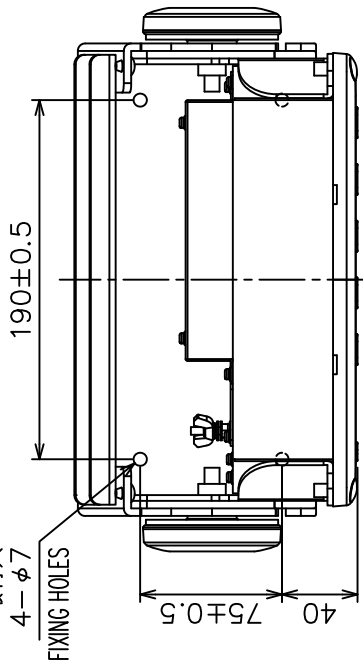
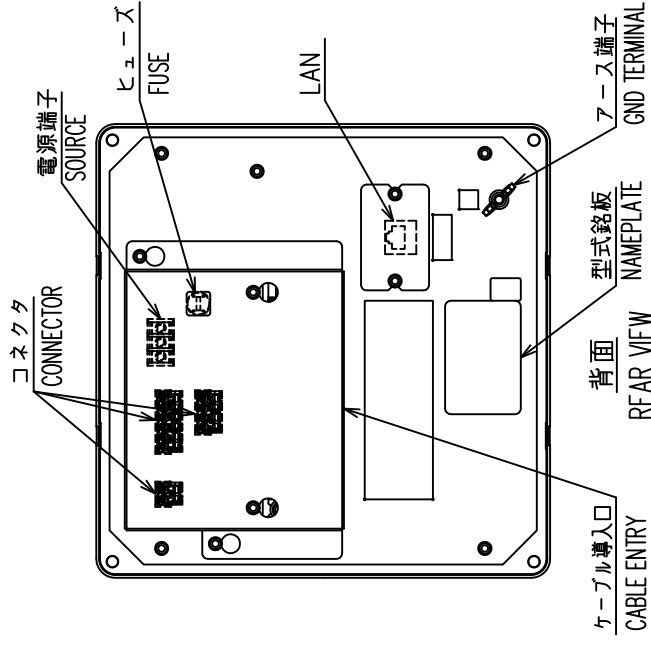
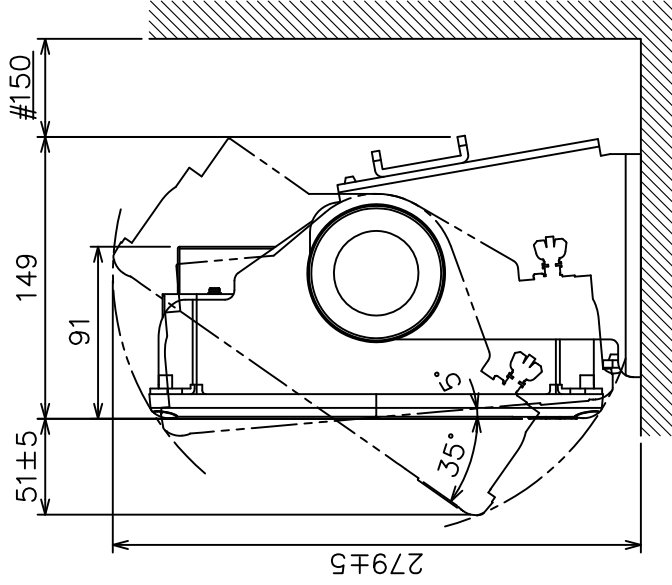
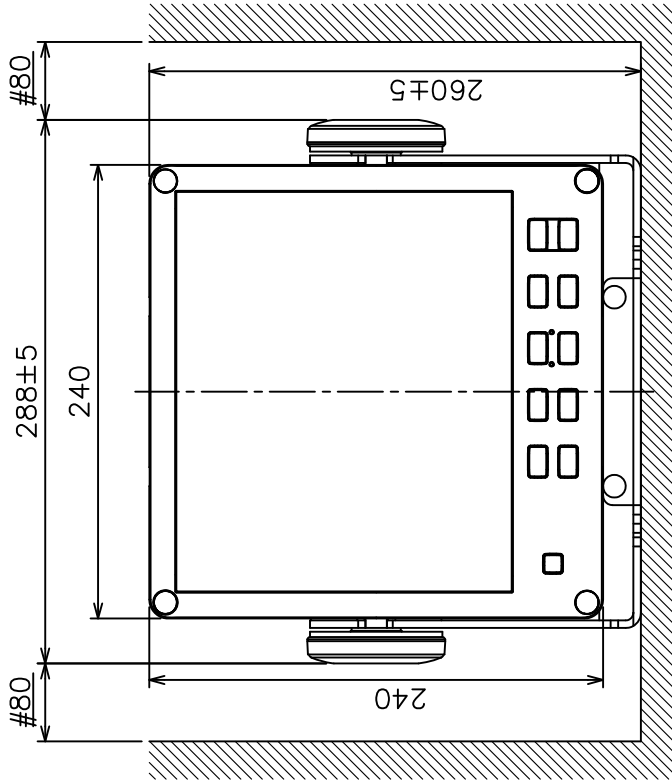

- 注記
- 1) 指定外の寸法公差は表1による。
 - 2) #印寸法は最小サービスクリアランスとする。
 - 3) 取付用ネジはバイネジ呼び径5×20を使用のこと。
- NOTE
1. TABLE 1 INDICATES TOLERANCE OF DIMENSIONS WHICH IS NOT SPECIFIED.
 2. #: MINIMUM SERVICE CLEARANCE.
 3. USE BIND TAPPING SCREWS φ5x20 FOR FIXING THE UNIT.

DRAWN	5/Mar/2010	T.YAMASAKI	TITLE	DS-600
CHECKED	5/Mar/2010	I.TAKAHASHI	名称	指示器 (卓上装備)
APPROVED	9/Mar/2010	Y.NISHIYAMA	外寸図	
SCALE	1/4	100g 3.3 kg	NAME	DISPLAY UNIT (TABLETOP MOUNT)
DWG.No.	C7264-G01-C	REF.No.	66-027-101G-5	OUTLINE DRAWING

表1 TABLE 1

寸法区分 (mm) DIMENSION	公差 (mm) TOLERANCE
L ≤ 50	±1.5
50 < L ≤ 100	±2.5
100 < L ≤ 500	±3

Fマウント用スポンジ (防水用)
FLUSH MOUNT SPONGE
FOR WATERPROOFING

本体
MAIN UNIT

取付部断面 (尺度: 1/1)
SLICE OF FIXING (SCALE: 1/1)

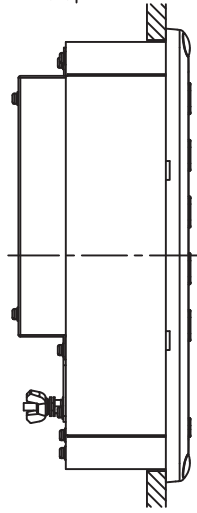

取付穴
4-φ6
FIXING HOLES

4-取付穴
PILOT HOLES

240
223±0.5

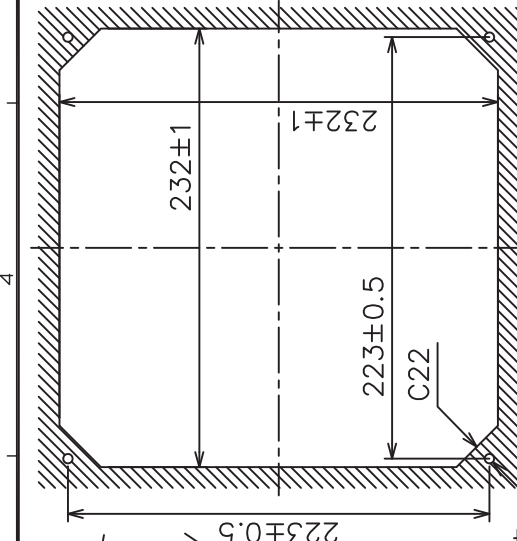
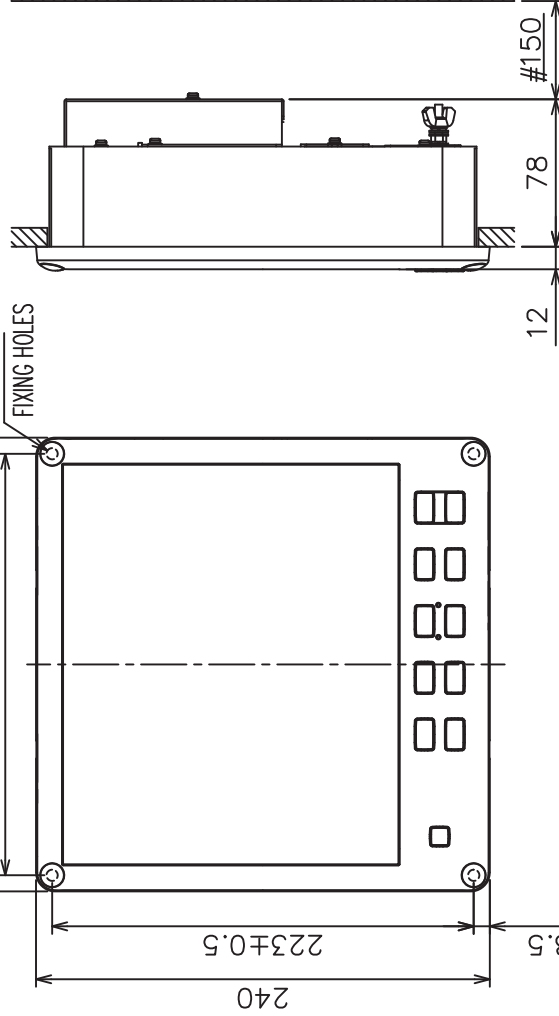

取付穴寸法 (屋内装備時)
CUTOOUT DIMENSIONS (INDOOR INSTALLATION)

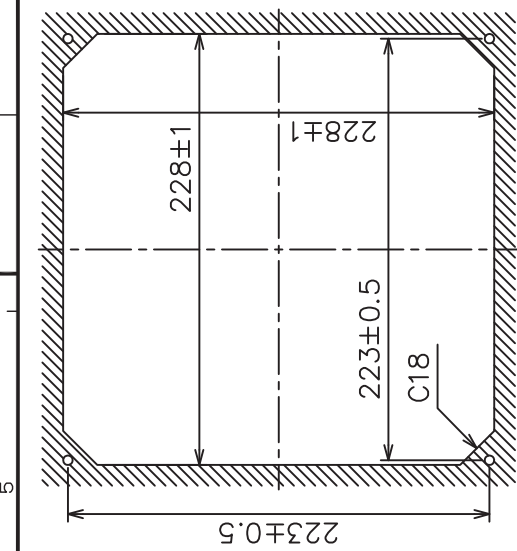

取付穴寸法 (屋外装備時)
CUTOOUT DIMENSIONS (OUTDOOR INSTALLATION)

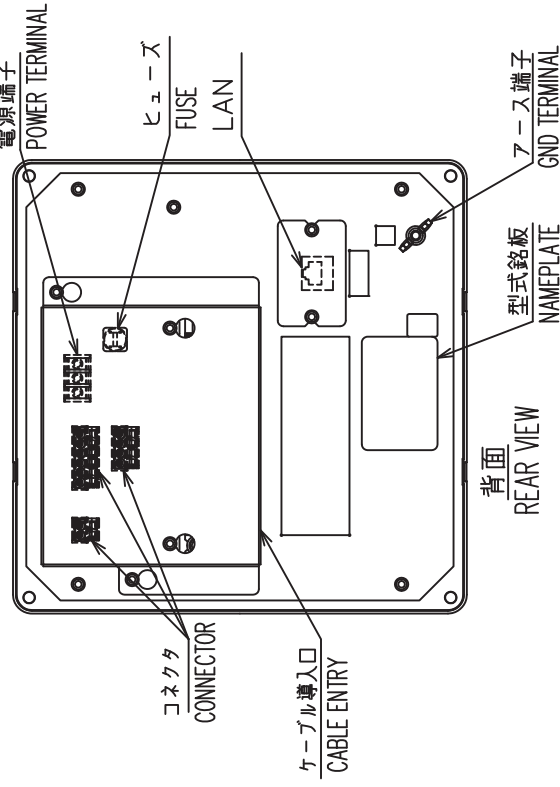

背面
REAR VIEW

- 注記
- 1) 指定外の寸法公差は表1による。
 - 2) #印寸法は最小サービスマウントピッチとする。
 - 3) 取付用ネジはバインドタックピンネジ呼び径5×2.0を使用のこと。
- NOTE
1. TABLE 1 INDICATES TOLERANCE OF DIMENSIONS WHICH IS NOT SPECIFIED.
 2. #: MINIMUM SERVICE CLEARANCE.
 3. USE BIND TAPPING SCREWS $\phi 5 \times 2.0$ FOR FIXING THE UNIT.

DRAWN	17/Dec/2012	I. YAMASAKI	TITLE	DS-600
CHECKED	17/Dec/2012	H. MAKI	名称	指示器 (埋込装備)
APPROVED	18/Dec/2012	Y. NISHIYAMA	NAME	DISPLAY UNIT (FLUSH MOUNT)
SCALE	1/4	WASS 2.1 kg	REF.No.	66-027-102G-6
DWG.No.	C7264-G02-D			

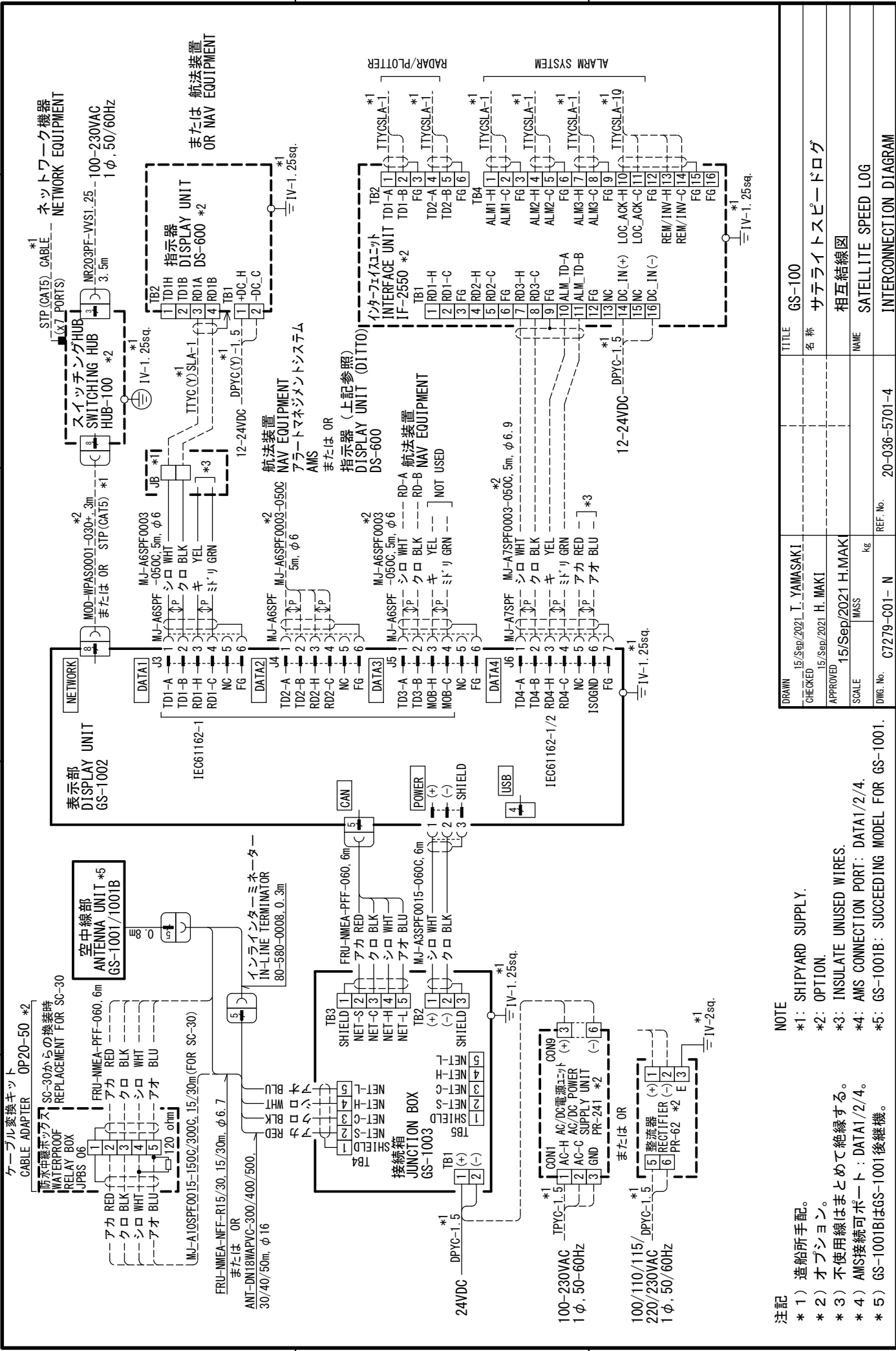

注記

- * 1) 造船所手配。
- * 2) オプション。
- * 3) 不使用線はまとめて絶縁する。
- * 4) AMS接続可ポート : DATA1/2/4。
- * 5) GS-1001BはGS-1001後継機。

NOTE

- *1: SHIPYARD SUPPLY.
- *2: OPTION.
- *3: INSULATE UNUSED WIRES.
- *4: AMS CONNECTION PORT: DATA1/2/4.
- *5: GS-1001B: SUCCEEDING MODEL FOR GS-1001.

DRAWN	15/Sep/2021	T. YAMASAKI	TITLE	GS-100
CHECKED	15/Sep/2021	H. MAKI	名称	サテライトスピードログ
APPROVED	15/Sep/2021	H. MAKI	相互結線図	
SCALE	1/MASS	kg	NAME	SATELLITE SPEED LOG
DWG. No.	C7279-C01-N	REF. No.	INTERCONNECTION DIAGRAM	

INDEX

Numerics

3-axis speed display..... 2-5

A

Alert listAP-26

Alert mode 8-23

Alerts

acknowledging 5-4

definition 5-1

list 5-3

log 5-4

overview 5-1

B

Background color 2-2

Backup 7-7

Berthing display

berthing line 6-11

overview 6-1

range 6-7

track 6-8

vector time 6-7

Brilliance 1-4

C

Control description

DS-600 6-3

GS-1002 1-1

Current direction 3-1

D

Datum 8-18

Dead reckoning time 3-8

Demo mode 3-5

Device information 3-10

Device instance 3-10

Device list 3-9

Device mode 8-17

Digital interfaceAP-13

Disable satellite

GNSS 3-7

Display modes 2-1

DS-600

displayAP-29

installation 8-25

menu settings 8-27

E

Equipment ID 8-19

Equipment information 7-4

Ethernet setting 3-12

F

Fuse replacement 7-1

G

Geodetic chart listAP-11

GNSS 2-6

I

IF-2503 8-24

Input data selection 3-13

Integrity display 2-5

IP address 8-24

J

Jis cable guideAP-25

K

Key sound 1-2

L

Language selection 8-17

Life of LCD 7-2

Line monitor log 3-14

List of symbolsAP-9

List of termsAP-5

List overview 1-6

M

Main menu overview 1-5

Maintenance 7-1

Master sensor 3-10

Memory clear 3-16

Menu treeAP-1

Mounting

antenna unit 8-3

display unit 8-1

junction box 8-7

N

Navigation display 2-2

Notice

ship speed 4-1

sound 4-1

trip 4-2

O

Offset 8-19

Output data setting 3-11

P

Parts listAP-22

Parts locationAP-23

Password 3-4

Power on/off 1-3

Product information 3-10

R

Replacement parts settings 7-8

S

Satellite angle 2-7

Satellite elevation 3-7

SBASAP-12

SDME mode 2-1

Self test 7-5

Sensor reset 3-8

INDEX

Setting reset.....	3-8
Signal noise ratio	2-7
Smoothing	3-1
SNTP setting	3-5
Speed test.....	8-30
System configurations.....	x
System instance.....	3-10
T	
THD mode.....	2-1
Time differences	AP-10
Time format.....	8-18
Total distance.....	3-3
Trip distance calculation	3-3
Troubleshooting	7-3
U	
Unit selection	8-17
W	
Wind angle	3-1
Wiring	
antenna unit	8-12
display unit	8-11
interconnection.....	8-8
junction box.....	8-9

Declaration of Conformity



0560

We **FURUNO ELECTRIC CO., LTD.**

(Manufacturer)

9-52 Ashihara-Cho, Nishinomiya City, 662-8580, Hyogo, Japan

(Address)

declare under our sole responsibility that the product

SATELLITE SPEED LOG GS-100

(Serial No. 1000-11xx/26xx-xxxx)

(Model name, type number)

to which this declaration relates conforms to the following standard(s) or normative document(s)

IMO Resolution A.694(17)	IEC 61023 Ed.3.0: 2007
IMO Resolution A.824(19)	IEC 61162-1 Ed.5.0: 2016
IMO Resolution MSC.36(63)	IEC 61162-2 Ed.1.0: 1998
IMO Resolution MSC.97(73)	IEC 61162-450 Ed.2.0: 2018
IMO Resolution MSC.116(73)	IEC 62288 Ed.2.0: 2014
IMO Resolution MSC.191(79)	IEC 60945 Ed.4.0: 2002
IMO Resolution MSC.302(87)	IEC 62923-1/2 Ed.1.0: 2018
	ISO 22090-3 Ed.2.0: 2014

(title and/or number and date of issue of the standard(s) or other normative document(s))

For assessment, see

- EC Type Examination (Module B) certificate No. MEDB000039C (SDME) Rev.2 and MEDB000039H (THD) Rev.2 issued by DNV AS (0575), Norway.
- Product Quality System (Module D) certificate No. P 112 (Issue 56) issued by Telefication, The Netherlands.

This declaration is issued according to the Directive 2014/90/EU of the European Parliament and of the Council on marine equipment, and the Implementing Regulation (EU) 2020/1170.

On behalf of Furuno Electric Co., Ltd.

Nishinomiya City, Japan
15 June 2021

(Place and date of issue)

Akihiko Kanechika
Department General Manager
Quality Assurance Department

(name and signature or equivalent marking of authorized person)